



# CATALOG

## 2021/22

Status: 10.2021









**01 High pressure adhesive grease**  
High press

- ▶ Item no. 2894-445-1
- ▶ Content: 400 ml
- ▶ Quantity per box: 24

- ▶ Technical specifications
- highly water-repellent
- extremely pressure resistant
- free of sticky polymer thickeners, therefore does not bind dirt
- silicone free
- excellent adhesive properties
- very good creeping ability
- Temperature resistance from - 20 ° C to 140 ° C (briefly 180 ° C)
- Color: beige / transparent

**Replacement spray head**  
with capillary tube

- ▶ Item no. 2897-300-140
- ▶ PU: 2



**02 High pressure adhesive grease**  
High Press Protect

- ▶ Item no. 2894-445-5
- ▶ Content: 400 ml
- ▶ Quantity per box: 12

- ▶ Technical specifications
- H1 food approval
- extremely stable and adhesive
- salt and hot water resistant
- free of sticky polymer thickeners (therefore does not bind dirt)
- silicone free
- excellent high pressure and high temperature properties
- flashes off quickly
- high layer thickness
- good creep properties
- For all high-pressure vehicle parts such as: door hinges, gear wheels, motorcycle chains, wire ropes, chains, wire ropes, hinges, etc.
- Temperature resistance from -20 ° C to 150 ° C
- NSF Registration No. 151238

**Replacement spray head**  
with capillary tube

- ▶ Item no. 2897-300-140
- ▶ PU: 2



**03 Adhesive grease**  
High-Press Ultra

- ▶ Item no. 2894-445-3
- ▶ Content: 400 ml
- ▶ Quantity per box: 12

- ▶ Technical specifications
- lubricates all kinds of moving machine parts such as hinges, door straps, chains, gears, wire ropes, slide rails, etc.
- extremely creeping
- extremely adhesive
- high pressure resistance
- salt and hot water resistant
- Temperature resistance from - 20 ° C to 140 ° C (briefly 180 ° C)
- silicone free
- Color: light blue

**Replacement spray head**  
with capillary tube

- ▶ Item no. 2897-300-140
- ▶ PU: 2







**01 High pressure adhesive grease**  
High-Press Black

- ▶ Item no. 2894-445-2
- ▶ Content: 400 ml
- ▶ Quantity per box: 24
- ▶ Technical specifications
  - suitable for use in all technical areas
  - high penetration ability
  - excellent adhesive properties
  - water-repellent and protects against corrosion
  - best running properties at high temperatures and speeds
  - Temperature resistance from -20 ° C to 200 ° C
  - silicone free
  - Color: Black

**Replacement spray head**  
with capillary tube

- ▶ Item no. 2897-300-140
- ▶ PU: 2



**02 White grease**  
Bio-Top Protect

- ▶ Item no. 2894-446
- ▶ Content: 400 ml
- ▶ Quantity per box: 24



- ▶ Technical specifications
  - water repellent
  - good lubricating properties
  - good abrasion resistance
  - rust-releasing
  - moisture displacing
  - universally applicable
  - pressure resistant
  - extremely durable
  - very good adhesive strength
  - silicone free
  - Temperature resistance from -10 ° C to 150 ° C



**03 Fully synthetic maintenance lubricating oil spray**  
Multi Protect

- ▶ Item no. 2894-445-6
- ▶ Content: 400 ml
- ▶ Quantity per box: 12
- ▶ Technical specifications



- fully synthetic
- resistant to oxidation
- extremely creeping
- flex-stable
- silicone free
- salt and hot water resistant
- optimal corrosion protection properties
- good high pressure and high temperature stability
- Temperature resistance from -30 ° C to 150 ° C



**Replacement spray head**  
with capillary tube

- ▶ Item no. 2897-300-140
- ▶ PU: 2







01  
**Multispray PTFE / ceramic oil spray**  
Teflux

- ▶ Item no. 2894-445-4
- ▶ Content: 400 ml
- ▶ Quantity per box: 12

- ▶ Item no. 2894-445-415
- ▶ Content: 150 ml
- ▶ Quantity per box: 12

- ▶ Technical specifications
- extremely creeping
- water-repellent and protects against corrosion
- high pressure resistance
- lubricates and oils moving machine parts of all kinds such as gears, hinges, etc.
- excellent emergency running properties thanks to PTFE and ceramic additives
- silicone free
- Color beige
- Odor: vanilla

**Replacement spray head**  
with capillary tube

- ▶ Item no. 2897-300-140
- ▶ PU: 2



02  
**Maintenance spray**  
ECO

- ▶ Item no. 2897-351-2
- ▶ Content: 600 ml
- ▶ Quantity per box: 12

- ▶ Technical specifications
- ensures reliable lubrication - even in the most remote places
- has a friction-reducing effect
- water repellent



03  
**Interior mounting spray**  
Soules Protect

- ▶ Item no. 2897-449-1
- ▶ Content: 300 ml
- ▶ Quantity per box: 12

- ▶ Technical specifications
- silicone free
- displaces moisture
- antistatic
- does not resinify and provides permanent protection against UV rays
- prevents door seals from freezing on





01

**Silicone spray**  
ECO

- ▶ Item no. 2897-322-2
- ▶ Content: 600 ml
- ▶ Quantity per box: 12

▶ Technical specifications

- reduces squeaking noises
- water repellent
- impregnating
- does not leave any stains
- temperature resistant from -50 ° C to 250 ° C

02

**Silicone spray**  
Siprem

- ▶ Item no. 2897-322
- ▶ Content: 400 ml
- ▶ Quantity per box: 12

▶ Technical specifications

- high quality silicone with a minimum content of 18%
- extremely water repellent
- does not leave any stains
- very high lubricating power

03

**Silicone grease spray**  
Siltron

- ▶ Item no. 2897-324
- ▶ Content: 400 ml
- ▶ Quantity per box: 12

▶ Technical specifications

- highly water-repellent
- lubricates and seals
- is compatible with elastomers
- does not resinify and is extremely resistant to aging
- insulates surfaces against leakage currents and flashovers, even at high and low temperatures

04

**Dry lubricant**  
TT - power

- ▶ Item no. 2897-447
- ▶ Content: 400 ml
- ▶ Quantity per box: 12

▶ Technical specifications

- invisible, almost imperceptible sliding film
- oil-free, grease-free, silicone-free
- prevents dust generation
- antistatic



**Replacement spray head**  
with capillary tube

- ▶ Item no. 2897-300-140
- ▶ PU: 2



**Replacement spray head**  
with capillary tube

- ▶ Item no. 2897-300-140
- ▶ PU: 2







01  
**„Inspection and Maintenance“ starter set**  
 6 pieces

► Item no. 2897-000-001

- 1x Siprem Silicone Premium - silicone spray 400ml (Item 2897-322)
- 1x Teflux - PTFE / ceramic oil spray 400ml (item 2894-445-4)
- 1x Off-Shore Silver - brake protection spray 400ml (item 2894-449)
- 1x TT-Power - dry lubricant 400ml (Item 2897-447)
- 1x High-Press Ultra - high pressure adhesive lubricant 400ml (Item 2894-445-3)
- 1x Super Crack Ultra - ice spray 400ml (Item 2894-442-1)



02  
**„Protect“ starter set**  
 6 parts



► Item no. 2897-000-002

- 1x Oxim Protect - rust remover 400ml (Art. 2894-444-1)
- 1x High Press Protect - high pressure adhesive lubricant 400ml (Art. 2894-445-5)
- 1x Multi Protect - maintenance oil spray 400ML (Art. 2894-445-6)
- 1x Bio-Top white Protect - lubricating grease 400ml (Art. 2894-446)
- 1x New Look Protect - cockpit care 400ml (Art. 2897-337-1)
- 1x Anitlox Protect - welding protection 400ml (Art. 2893-908)





01  
**Multipurpose grease**  
BG-B

- ▶ Item no. 2986-02
- ▶ Content: 400 g
- ▶ Quantity per box: 12
  
- ▶ Technical specifications
  - for drive shafts
  - mechanically highly resilient
  - acid free
  - with graphite
  - Contains solid lubricant
  - water repellent
  - anti-corrosive
  - Color: Black
  - Temperature resistance from -30 ° C to 120 ° C
  - NLGI class 2



02  
**Multipurpose grease**  
BG-Y

- ▶ Item no. 2986-021
- ▶ Content: 400 g
- ▶ Quantity per box: 12
  
- ▶ Technical specifications
  - mechanically highly resilient
  - silicone free
  - acid free
  - flex-stable
  - resistant to oxidation
  - water repellent
  - anti-corrosive
  - NLGI class 2
  - Color yellow
  - Temperature resistance from -30 ° C to 120 ° C



03  
**Lever grease gun**

- ▶ Item no. 7986-0
  
- ▶ Technical specifications
  - M10 x 1
  - for 400g cartridges or 500g loose fat
  - Short stroke system
  - stepless piston rod fixation
  - Fill / vent valve
  - ergonomic handle, according to DIN 1283
  - TÜV, DLG, BLT tested



04  
**High pressure armored hose**  
for lever grease gun (Item No. 7986-0)

- ▶ Item no. 7986-03
  
- ▶ Technical specifications
  - M10 x 1



05  
**Hydraulic grip mouthpiece**  
for lever grease gun (Item No. 7986-0)

- ▶ Item no. 7986-04
  
- ▶ Technical specifications
  - M10 x 1
  - according to DIN 71412
  - for grease gun (7986-0)



06  
**Hydraulic safety grip mouthpiece**  
Safelock

- ▶ Item no. 7986-05
  
- ▶ Technical specifications
  - M10 x 1
  - with hardened 4-jaws made of tool steel
  - with high-performance hydraulic seal
  - with integrated linear swivel joint
  - with integrated check valve
  - Uncoupling possible up to a pressure of over 600 bar
  - no splashing away when uncoupling
  - Outside diameter according to DIN
  - Made in Germany





01

**One-hand lever grease gun**

- ▶ Item no. 7986-1
- ▶ Technical specifications
  - with galvanized steel grease container
  - ergonomically shaped lever mechanism
  - Pressure output approx. 300 bar
  - open the cartridge without tools
  - easy, fast and absolutely clean loading and removal of the grease cartridges - without opening the press
  - no venting necessary
  - optimal residual emptying of the cartridges
  - Hose length: 30cm



02

**Multipurpose grease**  
Greasal

- ▶ Item no. 2986-031
- ▶ Content: 400 g
- ▶ Quantity per box: 12
- ▶ Technical specifications
  - smooth, brisk texture
  - soft consistency
  - acid-free, mill-stable
  - resistant to oxidation
  - rust preventive
  - Temperature resistance from -30 °C to 120 °C
  - NLGI class 2 (2K-30 according to DIN 51 502)
  - Screw cartridge (Lube Shuttle system cartridges)



03

**Cartridge adapter TG**  
LS 500

- ▶ Item no. 7986-2
- ▶ Technical specifications
  - Use: with our one-hand lever grease gun Art. No. 7986-1
  - for dispensing 500ml Lube Shuttle grease cartridges with screw thread (large thread)



04

**Starter set**  
Lubricating greases

- ▶ Item no. 2897-000-005
  - 1 x 400ml high pressure adhesive lubricant High Press (Item No. 2894-445-1)
  - 1 x 400ml high pressure adhesive lubricant High Press black (Art.-No. 2894-445-2)
  - 1 x 400ml high pressure adhesive lubricant High Press ultra (Art.-No. 2894-445-3)
  - 1 x 400ml high pressure adhesive lubricant High Press Protect (Art.No. 2894-445-5)
  - 1 x 400ml lubricating grease white Bio-Top Protect (Item No. 2894-446)
  - 1 x 400ml Siltron silicone grease (item no. 2897-324)







01

**Rust remover**  
Oxime

- ▶ Item no. 2894-441-1
- ▶ Content: 5 litres
- ▶ Technical specifications
  - loosens stuck, rusted screw connections
  - works quickly and effectively
  - very high lubricating properties
  - moisturizing
  - displacing water
  - prevents further rust formation
  - Temperature range: -20 ° C to 250 ° C



- ▶ Item no. 2000-000-005
- ▶ Pouring tap
- ▶ for 5 liter containers



02

**Rust remover spray**  
Oxime Ultra

- ▶ Item no. 2894-444
- ▶ Content: 400 ml
- ▶ Quantity per box: 24
- ▶ Technical specifications
  - very high lubricating properties
  - has a moisturizing effect
  - displacing water
  - preventive against further rusting
  - Temperature resistance from -20 ° C to 250 ° C



**Replacement spray head**  
with capillary tube

- ▶ Item no. 2897-300-140
- ▶ PU: 2



03

**Rust remover**  
Oxime Protect

- ▶ Item no. 2894-444-1
- ▶ Content: 400 ml
- ▶ Quantity per box: 24
- ▶ Technical specifications
  - use against rust, squeaking and creaking noises
  - prevents further rusting
  - Temperature resistance from -20 ° C to 250 ° C







01  
**Ice rust remover**  
Super crack ultra

- ▶ Item no. 2894-442-1
- ▶ Content: 400 ml
- ▶ Quantity per box: 12
  
- ▶ Technical specifications
- very good creeping ability
- highly effective corrosion protection
- permanently water-repellent
- guarantees an extreme relubrication effect
- very icy, cools down to -40 ° C
- High-performance release agent with silver-colored aluminum particles



02  
**Kraft Multi rust remover with cold shock effect**  
Multi crack

- ▶ Item no. 2894-500
- ▶ Content: 250 ml
- ▶ Quantity per box: 12
- ▶ Technical specifications
- extremely rust-releasing properties
- long-lasting effect
- absolutely free of mineral oil
- very good creeping ability
- Cold shock effect down to -40 ° C
- effective quickly
- unique active ingredient formula
- Multifunctional spray head for point and area jets
- silicone free
- Transport lock on the back of the spray head



03  
**Injector, glow plug and spark plug remover**  
Inject crack

- ▶ Item no. 2894-440
- ▶ Content: 250 ml
- ▶ Quantity per box: 12
  
- ▶ Technical specifications
- removes incrustations and oil residues
- up to 50% lower creep effect than e.g. a standard rust remover
- free from mineral oils, acids and silicones
- very economical in use due to the high proportion of active ingredients





01

**Brake cleaner**

Bremtec

- ▶ Item no. 2897-333-600
- ▶ Content: 600 ml
- ▶ Quantity per box: 24
  
- ▶ Item no. 2897-333-5
- ▶ Content: 5 litres
- ▶ PU: 1
  
- ▶ Item no. 2897-333-31
- ▶ Content: 30 litres
- ▶ PU: 1
  
- ▶ Technical specifications
- containing acetone
- has a degreasing effect



**Pouring tap**

- ▶ Item no. 2000-000-005
- ▶ PU: 1
- ▶ for 5 liter containers
  
- ▶ Item no. 2000-000-030
- ▶ PU: 1
- ▶ for 30 liter containers



**R3 / 4 "metal pouring tap**

- ▶ Item no. 2000-000-062
- ▶ PU: 1
- ▶ Discharge tap for 60 litre container



**Closure adapter for metal pouring tap**

- ▶ Item no. 2000-000-061
- ▶ PU: 1
- ▶ Adapter for 30 and 60 litre containers



02

**Pressure pump spray bottle**  
for acidic liquids

- ▶ Item no. 2897-333-100
  
- ▶ Technical specifications
- Operating pressure 3 bar
- unfilled
- Capacity 1 liter
- Labels available separately for better recognition

**Replacement seal**

- ▶ Item no. 2897-333-101

**Application bottle label**  
for Bremtec brake cleaner

- ▶ Item no. 1960-000-1



03

**Compressed air spray bottle**  
refillable

- ▶ Item no. 2897-900
- ▶ Content: Aquano
- ▶ PU: 1
  
- ▶ Technical specifications
- Suitable for all liquid materials that can be worked using compressed air



**Headboard complete**

- ▶ Item no. 2897-900-15
- ▶ PU: 1



**Spray head jet**

- ▶ Item no. 2897-900-12
- ▶ PU: 1



**Spray head vortex**

- ▶ Item no. 2897-900-13
- ▶ PU: 1

**Riser pipe**

- ▶ Item no. 2897-900-16
- ▶ PU: 5



**O-ring**

- ▶ Item no. 2897-900-11
- ▶ PU: 1



**Union nut**

- ▶ Item no. 2897-900-10
- ▶ PU: 1







01

**Brake cleaner**

MC-1

- ▶ Item no. 2897-333-500
- ▶ Content: 500 ml
- ▶ Quantity per box: 30
- ▶ Technical specifications
  - acetone-free quality cleaner
  - very effectively removes oil, dirt, brake fluid and lining abrasion from disc brakes, brake pads and linings as well as many other vehicle parts
  - washes out impurities and deposits
  - removes oil, grease, dust and resin residues, brake fluid and lining wear from disc brakes
  - Thanks to careful lubrication, the service life of the machined components is increased



02

**Brake cleaner, safety cleaner**

Bremtec Safe

- ▶ Item no. 2897-333-700
- ▶ Content: 500 ml
- ▶ Quantity per box: 12
- ▶ Item no. 2897-333-730
- ▶ Content: 30 litre
- ▶ PU: 1
- ▶ Technical specifications
  - flame retardant propellant
  - lower explosion limit > 1.5% vol.
  - Recommended product according to the Ordinance on Hazardous Substances (protection level 2)
  - 25% naphtha colorless

**Pouring tap**

for 30 liter containers

- ▶ Item no. 2000-000-030
- ▶ PU: 1



03

**Pressure pump spray bottle**

for Bremtec Safe

- ▶ Item no. 2897-333-170
- ▶ Technical specifications
  - Operating pressure 3 bar
  - unfilled
  - Capacity 1 liter
  - Labels available separately for better recognition
  - including a replacement seal set (Item No. 2897-333-171)
  - For filling with the following Normfest product:
  - Bremtec Safe brake cleaner

**Replacement seal**

for Bremtec Safe bottle

- ▶ Item no. 2897-333-171
- ▶ PU: 1





01

**Copper fat paste**  
COP

- ▶ Item no. 2894-451-1
- ▶ Content: 250 g can
- ▶ Quantity per box: 5
  
- ▶ Item no. 2894-450
- ▶ Content: 400 ml
- ▶ Quantity per box: 12
  
- ▶ **Technical specifications**
- high pressure resistant
- temperature resistant up to 1,200 ° C
- anti-corrosive
- water resistant
- extremely adhesive
- resistant to oxidation
- silicone free
- do not apply to friction surfaces
- NOT RECOMMENDED FOR ABS VEHICLES



03

**High-performance brake and assembly spray**  
500ml

- ▶ Item no. 2894-452
- ▶ Content: Aquano
- ▶ Quantity per box: 6
  
- ▶ **Technical specifications**
- for extremely temperature and pressure loaded sliding surfaces
- Excellent lubricating effect over a wide temperature range from -30 ° C to 1,350 ° C
- wide range of uses and high long-term effect
- very good adhesion to almost all surfaces
- non-conductive
- extremely resistant to water, alkalis, diluted acids and corrosion
- effectively prevents brake parts or the like from sticking.
- Allows easy dismantling even of hot screws on screw connections subject to high temperatures



04

**Brake protection spray**  
Off-shore silver

- ▶ Item no. 2894-449
- ▶ Content: 400 ml
- ▶ Quantity per box: 12
  
- ▶ **Technical specifications**
- Sweat, splash and salt water resistant
- very good and lasting lubricating effect
- long-term corrosion protection
- is particularly suitable for vehicles with ABS braking systems
- Temperature resistance up to 1,400 ° C
- metal free
- prevents corrosion and squeaking noises
- silicone free
- Cold flow properties guarantee that the product remains in place at all times



05

**Brake protection paste**  
Off-shore silver

- ▶ Item no. 2894-449-200
- ▶ Content: 200 g
- ▶ Quantity per box: 12
  
- ▶ **Technical specifications**
- Sweat, splash and salt water resistant
- very good and lasting lubricating effect
- long-term corrosion protection
- is particularly suitable for vehicles with ABS braking systems
- temperature resistant up to 1,400 ° C
- silicone free



**Replacement brush for off-shore**  
with protective cover

- ▶ Item no. 2894-448-201
- ▶ PU: 1





01  
**brake fluid**  
DOT4

- ▶ Item no. 2894-410
- ▶ Content: 5 litres
- ▶ PU: 1
  
- ▶ Item no. 2894-410-30
- ▶ Content: 30 litre
- ▶ PU: 1
  
- ▶ Technical specifications
- Wet boiling point above 160 ° C
- Boiling point over 250 ° C



02  
**brake fluid**  
DOT4 Plus

- ▶ Item no. 2894-415
- ▶ Content: 5 litres
- ▶ PU: 1
  
- ▶ Item no. 2894-415-30
- ▶ Content: 30 litre
- ▶ PU: 1
  
- ▶ Technical specifications
- suitable for all hydraulic brake systems with synthetic fluid
- Wet boiling point above 180 ° C
- Boiling point over 260 ° C



**Pouring tap**

- ▶ Item no. 2000-000-005
- ▶ PU: 1
- ▶ for 5 liter containers
  
- ▶ Item no. 2000-000-030
- ▶ PU: 1
- ▶ for 30 liter containers



**Tester**  
for brake fluids

- ▶ Item no. 8715-999-50
- ▶ PU: 1
- ▶ Replacement battery 3722-24



03  
**High performance brake fluid**  
DOT 4 LV high performance

- ▶ Item no. 2894-435
- ▶ Content: 5 litres
- ▶ PU: 1
  
- ▶ Item no. 2894-430
- ▶ Content: 30 litres
- ▶ PU: 1
  
- ▶ Technical specifications
- especially with Ford approval
- suitable for all hydraulic brake systems with synthetic fluid
- miscible with brake fluids of the same specification
- neutral behavior towards brake parts
- increased safety through reduced boiling point drop
- corresponds to DOT-4 FMVSS 116 and SAEJ 1703
- Boiling point over 265 ° C
- Wet boiling point above 175 ° C



01

**Airpress filling station**

- ▶ Item no. 2897-910-100
- ▶ Technical specifications
- universal use in many industrial sectors
- there is no need to buy any spray
- no disposal costs
- no environmental pollution from the use of air as a propellant



02

**Airspray pressure bottle for Bremtec A2**

- ▶ Item no. 2897-910-1
- ▶ Content: 400 ml
- ▶ PU: 1



03

**Airspray pressure bottle for Bremtec**

- ▶ Item no. 2897-910-2
- ▶ Content: 400 ml
- ▶ PU: 1



04

**Airspray pressure bottle for oxime**

- ▶ Item no. 2897-910-3
- ▶ Content: 400 ml
- ▶ PU: 1



**Material air valve**

- ▶ Item no. 2897-910-103
- ▶ PU: 1



**Air valve**

- ▶ Item no. 2897-910-104
- ▶ PU: 1



**Seal holder with groove ring**

- ▶ Item no. 2897-910-105
- ▶ PU: 1



**Plug nipple with external thread 1/4 „**

- ▶ Item no. 8699-25-531
- ▶ PU: 1



**Spare part material / air**

- ▶ Item no. 2897-910-106
- ▶ PU: 1



**Seal kit for the Air Press filling station**

- ▶ Item no. 2897-910-107
- ▶ PU: 1



**Barrel connection including accessories for 60 liters**

- ▶ Item no. 2897-910-110
- ▶ PU: 1



**Valve with riser pipe**

- ▶ Item no. 2897-910-101
- ▶ PU: 1



**Spray head with round jet**

- ▶ Item no. 2897-910-102
- ▶ PU: 1



**Spray head with point jet**

- ▶ Item no. 2897-910-108
- ▶ PU: 1





01

**silicone**

Silon Black

- ▶ Item no. 2896-640-2
- ▶ Content: 200 ml
- ▶ Quantity per box: 12

▶ **Technical specifications**

- hardens to a hard, rubber-like mass with practically no shrinkage (<3%) as soon as it is exposed to air humidity
- adheres to metal, glass, painted surfaces, ceramics and most plastic surfaces
- resistant to weather conditions, vibrations, moisture
- temperature resistant from -50 ° C to 230 ° C

**Replacement pistol grip**  
for Silon



- ▶ Item no. 2896-640-3
- ▶ PU: 1

02

**silicone**

Silon Red

- ▶ Item no. 2896-640-1
- ▶ Content: 200 ml
- ▶ Quantity per box: 12

▶ **Technical specifications**

- hardens to a hard, rubber-like mass with practically no shrinkage (<3%) as soon as it is exposed to air humidity
- adheres to metal, glass, painted surfaces, ceramics and most plastic surfaces
- resistant to weather conditions, vibrations, moisture
- temperature resistant from -50 ° C to 300 ° C

**Replacement pistol grip**  
for Silon



- ▶ Item no. 2896-640-3
- ▶ PU: 1



03

**Seal remover**

Seal-Ex

- ▶ Item no. 2896-663
- ▶ Content: 400 ml
- ▶ Quantity per box: 12

▶ **Technical specifications**

- applicable to objects made of metal, wood, ceramic, glass, polyethylene, polypropylene
- do not use on sensitive plastics such as PVC, linoleum and synthetic



**01**  
**Surface seal**  
green

- ▶ Item no. 2896-520
- ▶ Content: 50 g
- ▶ PU: 1
  
- ▶ **Technical specifications**
- max.gap filling capacity: 0.3 mm
- hand-tight in 20-40 min.
- functional in 1-3 hours
- Temperature resistance from -55 °C to 150 °C
- Resistant to water, mineral oils, synthetic lubricants, fuels, organic solvents and coolants

**02**  
**Surface seal**  
orange

- ▶ Item no. 2896-521
- ▶ Content: 50 g
- ▶ PU: 1
  
- ▶ **Technical specifications**
- max.gap filling capacity: 0.5 mm
- hand-tight in 15-30 min.
- functional in 1-3 hours
- Temperature resistance from -55 °C to 150 °C
- Resistant to water, mineral oils, synthetic lubricants, fuels, organic solvents and coolants



**03**  
**Pipe thread seal**

- ▶ Item no. 2896-550-51
- ▶ Content: 50 ml
- ▶ PU: 1
  
- ▶ **Technical specifications**
- replaces hemp, PTFE and solid sealant
- Parts can be readjusted after joining
- high quality waterproofing
- additional protection against corrosion
- 
- max.gap filling capacity: 0.50 mm
- max.thread: (metr) M80
- hand-tight in 15-30 min.
- functional in 1-3 hours
- Skill class (DIN 30661): 2
- Temperature resistance from -55 °C to 150 °C
- Resistant to petrol, diesel, water, water-glycol mixtures, mineral oils, hydraulic fluids
- Exception: acids and alkalis in high concentration as well as methylene chloride



**04**  
**Bushing and bearing mounting**

- ▶ Item no. 2896-540
- ▶ Content: 24 ml
- ▶ PU: 1
  
- ▶ **Technical specifications**
- Skill class (DIN 30661): 55-70
- max.gap filling capacity: 0.15 mm
- max.thread: (metr) M20
- Temperature resistance from -55 °C to 175 °C
- hand-tight in 2-5 min.
- functional in 1-3 hours



**05**  
**Permanently plastic universal seal**  
Plastomar

- ▶ Item no. 2896-502
- ▶ Content: 85 g
- ▶ Quantity per box: 10
  
- ▶ **Technical specifications**
- Maximum splitting capacity of 0.2 mm
- temperature resistant from -55 °C to 270 °C
- Let it flash off for 10 minutes
- silicone free
- with dosing nozzle
- Red color







**01**  
**Screw locking**  
medium strength

- ▶ Item no. 2896-531-50
- ▶ Content: 50 ml
- ▶ Quantity per box: 10
- ▶ Technical specifications
  - max.gap filling capacity: 0.25 mm
  - max.thread (metric) M36
  - hand-tight in 10-20 min.
  - functional in 1-3 hours
  - medium strength, strength class? (DIN 30661)
  - temperature resistant from -55 ° C to 150 ° C

**02**  
**Screw locking**  
extra strength

- ▶ Item no. 2896-530-50
- ▶ Content: 50 ml
- ▶ Quantity per box: 10
- ▶ Technical specifications
  - max.gap filling capacity: 0.15 mm
  - max.thread (metric) M20
  - hand-tight in 10-20 min.
  - functional in 1-3 hours
  - high strength, skill class (DIN 30661)
  - temperature resistant from -55 ° C to 150 ° C



**03**  
**Engine tight**  
Mot Seal

- ▶ Item no. 2897-374
- ▶ Content: 300 ml
- ▶ Quantity per box: 12
- ▶ Technical specifications
  - prevents blue-smoking exhausts
  - regenerates engine seals made of plastic and rubber
  - prevents pollution from oil dripping engines

**04**  
**Engine oil circuit cleaner**  
Mot Clean

- ▶ Item no. 2897-375
- ▶ Content: 500 ml
- ▶ Quantity per box: 12
- ▶ Technical specifications
  - gentle and quick cleaning
  - neutral to seals and other materials built into the engine
  - High profitability
  - simple application





01

**Radiator tight**

Wheel seal

- ▶ Item no. 2897-372
- ▶ Content: 150 ml
- ▶ Quantity per box: 12

▶ **Technical specifications**

- permanently and reliably seals hairline cracks and small leaks
- Compatible with antifreeze agents and coolants, neutral against rubber, plastics, light and non-ferrous metals
- no negative side effects on the water pump and heating circuit
- suitable for closed cooling systems
- suitable for aluminum coolers
- also suitable for preventive use

02

**Radiator cleaner**

Wheel clean

- ▶ Item no. 2897-373
- ▶ Content: 250 ml
- ▶ Quantity per box: 12

▶ **Technical specifications**

- chemical calcium conversion
- Removal of fat, limescale and oil
- Sludge dispersion
- neutral to the radiator materials used
- rubber and plastic compatible
- Compatible with frost protection
- does not contain any aggressive acids or alkalis
- one can is sufficient for a quantity of up to 10 liters of cooling water



03

**Diesel additive**

CT 60

- ▶ Item no. 2897-370
- ▶ Content: 300 ml
- ▶ Quantity per box: 12

▶ **Technical specifications**

- ensures cleanliness and prevents deposits in the fuel system and combustion chamber
- keeps the injection nozzles clean, ensures better engine combustion, which leads to lower specific fuel consumption and maximum engine performance
- prevents the injection nozzles from sticking and gumming up
- increases the lubricating effect of low-sulfur diesel fuels and protects the distributor injection pumps from wear
- compatible with all modern diesel oxidation catalysts



04

**Gasoline additive**

OT 100

- ▶ Item no. 2897-371
- ▶ Content: 300 ml
- ▶ Quantity per box: 12

▶ **Technical specifications**

- suitable for all gasoline injection systems
- cleans the injection system of fuel residues
- removes coking and deposits from flow dividers, injection valves, inlet valves and other components of the fuel system
- ensures optimal driving behavior and low fuel consumption through precise injection metering and atomization
- guarantees low levels of pollutants in the exhaust gas





01  
**Diesel intake system cleaner**  
DC980

- ▶ Item no. 2897-369
- ▶ Content: 400 ml
- ▶ Quantity per box: 8
  
- ▶ Technical specifications
  - Special cleaner with CO2 propellant
  - simple and targeted application
  - colorless and residue-free
  - powerful loosening power
  - over 95% active ingredient

02  
**Diesel soot particle filter cleaner**  
DPF100

- ▶ Item no. 2897-380
- ▶ Content: 400 ml
- ▶ Quantity per box: 12
  
- ▶ Technical specifications
  - Dissolves carbon deposits excellently
  - not flammable
  - Can be cleaned without dismantling the? Particle filter
  - to restore the full? absorption capacity of the diesel particulate filter

03  
**Throttle valve cleaner**  
VC 980

- ▶ Item no. 2897-368
- ▶ Content: 400 ml
- ▶ Quantity per box: 12
  
- ▶ Technical specifications
  - cleans the carburetor inside and out
  - flushes holes and nozzles
  - for cleaning components in the intake area
  - EGR valve (exhaust gas recirculation valve)

04  
**Marten repellent spray**  
Wild Guard

- ▶ Item no. 2897-329
- ▶ Content: 400 ml
- ▶ Quantity per box: 12
  
- ▶ Technical specifications
  - Helps to effectively deter martens
  - Double-effect means that electric cables, ignition cables, brake and coolant tubes, sleeves and fan belts are protected from marten bites
  - Reapplied after every engine and underbody wash

**Processing hose**

long, with spray head

- ▶ Item no. 2897-368-1
- ▶ PU: 1







01  
**Electrical contact cleaner**  
TermClean

- ▶ Item no. 2897-334
- ▶ Content: 400 ml
- ▶ Quantity per box: 12
- ▶ Technical specifications
  - Cleaning of all contacts
  - enables greasy dirt to be removed and loosens old incrustations
  - Safe to use with electrical and mechanical office machines, computers, cash registers, radio and television sets
  - including brush attachment?
  - The product is not suitable for use on parts that are in operation!



02  
**Contact helper**  
Contact

- ▶ Item no. 2897-331
- ▶ Content: 300 ml
- ▶ Quantity per box: 12
- ▶ Technical specifications
  - displaces moisture
  - improves electrical conductivity
  - silicone free



03  
**Battery pole protection spray**  
Poltec

- ▶ Item no. 2897-332-300
- ▶ Content: 300 ml
- ▶ Quantity per box: 12
- ▶ Technical specifications
  - insulates bare sheet metal and electrical connections against corrosion from environmental influences (salts, water, acids and alkalis, moisture, etc.)
  - weatherproof
  - resistant to oxidation
  - anti-corrosive
  - moisture repellent
  - prevents contact resistance and voltage drop
  - Temperature resistance from -30 °C to 130 °C
  - silicone free



04  
**Acid testers**  
for battery

- ▶ Item no. 8853-600-2
- ▶ PU: 1
- ▶ Technical specifications
  - easy to use
  - Clear scaling with three result areas
  - red (cell discharged)
  - yellow (cell satisfactory condition)
  - green (cell in good condition)





01

**Leak detector**

Spy Plus

- ▶ Item no. 2896-661
- ▶ Content: 400 ml
- ▶ Quantity per box: 12

▶ **Technical specifications**

- meets the requirements of DIN EN 14291
- non-flammable - leak detection also possible with flammable gases
- suitable for all technical gases in compressed air, compressed gas and air conditioning systems, compressors, welding equipment, compressed air braking systems, tires, hoses or transport tanks
- no stress corrosion cracking in plastics such as PVC or PE
- Temperature application range: -15 ° C to 50 ° C
- not corrosive

02

**Leak detector spray**

Spy Dry

- ▶ Item no. 2896-662-500
- ▶ Content: Aquano
- ▶ Quantity per box: 12

▶ **Technical specifications**

- to find leaks from which oil, gasoline or other liquids are leaking
- free of grease and silicone
- based on marble powder

03

**Icing spray**

Arctic

- ▶ Item no. 2897-325
- ▶ Content: 200 ml
- ▶ Quantity per box: 12

▶ **Technical specifications**

- Construction parts made of metal such as ball bearings, bushings, chain links, shafts, etc. can be inserted into the tightest of fits
- Faults in electrical circuits (due to thermal overload) can be easily found by local cooling
- removes dirt such as chocolate or chewing gum from upholstery

04

**Jump start spray**

Super start plus

- ▶ Item no. 2897-330-310
- ▶ Content: 300 ml
- ▶ Quantity per box: 12

▶ **Technical specifications**

- very high ignition properties
- enables a cold start even at extremely low temperatures
- improves starting behavior in wet conditions
- suitable for 2-stroke and 4-stroke petrol engines
- Also suitable for diesel engines (note the application note on the product: „Start diesel engines at full throttle and do not preheat!“)

**Replacement spray head**

with capillary tube

- ▶ Item no. 2897-300-140
- ▶ PU: 2





01

**Glass cleaner**  
Stries Protect

- ▶ Item no. 2897-340
- ▶ Inhalt: Aquano
- ▶ Quantity per box: 12

- ▶ Item no. 2897-340-5
- ▶ Inhalt: Uni-Star
- ▶ PU: 1

- ▶ Item no. 2897-340-30
- ▶ Inhalt: 30 liters
- ▶ PU: 1

- ▶ Technical specifications
- Leaves behind clear, shiny, streak-free and clean glass surfaces
- removes dirt, stains, fingerprints, grease, nicotine, flies, etc.
- can be used on glass and polycarbonate glass
- silicone and ammonia free
- has no abrasives

**Pouring tap**

- ▶ Item no. 2000-000-005
- ▶ for 5 liter containers
- ▶ PU: 1

- ▶ Item no. 2000-000-030
- ▶ for 30 litre container
- ▶ PU: 1



02

**High-tech special cleaner**  
Terpanol Power

- ▶ Item no. 2897-323
- ▶ Inhalt: Starter Set
- ▶ Quantity per box: 12

- ▶ Technical specifications
- contains orange terpenes from 100% renewable raw materials
- optimally removes adhesive residues, oils, fats, waxes, waterproof edging traces, graffiti
- stronger loosening force of the respective dirt
- Dissolve after a very short time (approx. 20 seconds)



03

**Interior intensive cleaner**  
Interno Protect

- ▶ Item no. 2000-05
- ▶ Content: 500 ml
- ▶ Quantity per box: 12

- ▶ Item no. 2000-05-5
- ▶ Inhalt: 5 litres
- ▶ PU: 1

- ▶ Technical specifications
- cares for hard and soft surfaces such as plastic, vinyl, chrome, sealing and door sill trims, car leather, upholstery and carpets
- Leaves a matt finish and a pleasantly fresh scent on plastic surfaces
- acid and silicone free
- does not contain hydrocarbon solvents
- not suitable for suede and alcantara
- ready to use



**Pouring tap**

- ▶ Item no. 2000-000-005
- ▶ for 5 liter containers
- ▶ PU: 1







03

**Lightning deicer**

Blizzard Ultra

- ▶ Item no. 2897-231
- ▶ Content: 500 ml
- ▶ Quantity per box: 6



- ▶ Technical specifications
- removes ice from icy car windows in a flash
- does not leave any streaks
- laborious scratching is no longer necessary

01

**Antifreeze for windscreen washer system**

Frostex

- ▶ Item no. 2897-314
- ▶ Content: 1000 ml
- ▶ Quantity per box: 12

- ▶ Item no. 2897-315
- ▶ Content: Uni-Star
- ▶ PU: 1

- ▶ Item no. 2897-318
- ▶ Content: 30 litre
- ▶ PU: 1

- ▶ Technical specifications
- methanol free
- undiluted, frost-proof down to -70 ° C
- suitable for fan nozzles and polycarbonate glasses



**Pouring tap**

- ▶ Item no. 2000-000-005
  - ▶ PU: 1
  - ▶ for 5 liter containers
- ▶ Item no. 2000-000-030
  - ▶ PU: 1
  - ▶ for 30 liter containers







**01 Frost protection tester**  
for cooling water

- ▶ Item no. 8853-600-1
- ▶ Technical specifications
  - Technically modern construction that has been tried and tested many times around the world
  - easy, quick and accurate measurement
  - stable plastic housing
  - Hanging loop
  - Pendulum pointer - no vertical position of the device required
  - automatic temperature compensation
  - Closure by rotary valve
  - no dripping, no drawing in of air
  - very long service life and measurement accuracy thanks to the mounting of the measuring disc and the pendulum pointer on a steel axle thus little influence from coolant contamination



**02 Frost protection tester**  
for the windscreen washer

- ▶ Item no. 8853-600-3
- ▶ Technical specifications
  - for isopropanol / methanol-water mixtures according to commercially available antifreeze for windscreen washer systems
  - with bulged plastic cylinder and glass areometer
  - Display range from 0 ° to -30 ° C with colored fields



**03 Washer concentrate**  
Summer goods

- ▶ Item no. 2897-313-30
- ▶ Content: 25 x 30 ml
- ▶ Item no. 2897-313-5
- ▶ Content: 5 litres
- ▶ PU: 1



- ▶ Technical specifications
  - Concentrate 1: 100
  - quickly and reliably removes stubborn dirt such as insects, oily films and waxes
  - Streak-free cleaning avoids dangerous stray light effects
  - does not create stress cracks in plastic headlights
  - Fan nozzles and polycarbonate glass suitable



**Dosing pump**  
for 5 liter containers

- ▶ Item no. 2897-313-509
- ▶ PU: 1
- ▶ Technical specifications
  - 1 stroke (2.5 ml)





01

**PVC hose**  
crystal clear

► **Technical specifications**

- silicone free
- food safe according to RoHS3 and REACH
- Material: soft PVC
- Shore hardness: approx. 78 ° Shore A
- Composition: PVC / lubricant / DOP plasticizer / organo-tin stabilizer (cadmium-free)
- Density: 1.19 g / cm<sup>3</sup>
- thermal application range: -20 ° C to 65 ° C
- Tolerances: according to DIN / EN 16940
- Short-term pressure load: at 20 ° C ambient temperature and flow medium as per overview
- Flammability: the material is flame-retardant and self-extinguishing when the flame is removed



Item No.	Wall thickness	Inside-Ø [mm]	length
5895-3	1,0 mm	3,0	15 m
5895-4	1,0 mm	4,0	15 m
5895-5	1,0 mm	5,0	15 m
5895-6	1,0 mm	6,0	15 m
5895-8	1,0 mm	8,0	15 m
5895-10	1,5 mm	10,0	10 m
5895-12	1,5 mm	12,0	10 m

02

**Reduction hose connector**

► **Technical specifications**

- Intermediate pieces for connecting different hose diameters



Item No.	for hose Ø	PU
5896-504-3	4 - 3 mm	25
5896-506-4	6 - 4 mm	25
5896-508-4	8 - 4 mm	25
5896-508-6	8 - 6 mm	25
5896-510-8	10 - 8 mm	25

03

**Hose connector straight**

► **Technical specifications**

- Oil and fuel resistant in the following temperature range: permanently -40 ° C to 80 ° C / briefly (up to 1h) up to max. 110 ° C
- high strength
- toughness
- light weight
- Damping ability
- Abrasion resistance
- great impact resistance

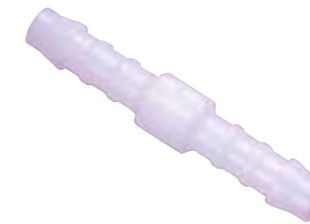

Item No.	for hose Ø	PU
5896-103	3 mm	25
5896-104	4 mm	25
5896-105	5 mm	25
5896-106	6 mm	25
5896-108	8 mm	25
5896-110	10 mm	25

05

**Angle hose connector**

► **Technical specifications**

- Oil and fuel resistant in the following temperature range: permanently -40 ° C to 80 ° C / briefly (up to 1h) up to max. 110 ° C
- high strength
- toughness
- light weight
- Damping ability
- Abrasion resistance
- great impact resistance



Item No.	for hose Ø	PU
5896-303	3 mm	25
5896-304	4 mm	25
5896-305	5 mm	25
5896-306	6 mm	25

04

**T-hose connector**

► **Technical specifications**

- Oil and fuel resistant in the following temperature range: permanently -40 ° C to 80 ° C / briefly (up to 1h) up to max. 110 ° C
- high strength
- toughness
- light weight
- Damping ability
- Abrasion resistance
- great impact resistance

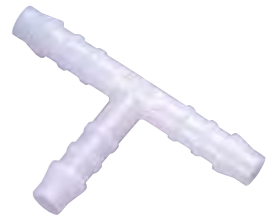

Item No.	for hose Ø	PU
5896-203	3 mm	25
5896-204	4 mm	25
5896-205	5 mm	25
5896-206	6 mm	25
5896-208	8 mm	25
5896-210	10 mm	25

06

**Y-hose connector**

► **Technical specifications**

- Oil and fuel resistant in the following temperature range: permanently -40 ° C to 80 ° C / briefly (up to 1h) up to max. 110 ° C
- high strength
- toughness
- light weight
- Damping ability
- Abrasion resistance
- great impact resistance



Item No.	for hose Ø	PU
5896-403	3 mm	25
5896-404	4 mm	25
5896-405	5 mm	25
5896-406	6 mm	25
5896-408	8 mm	25
5896-410	10 mm	25



01

**Plastic hose connector assortment**

160 pieces

► Item no. 1957-896

► Content:

- 10 x straight hose connector 3mm (Art.-No. 5896-103)
- 10 x straight tube connector 4mm (Art.-No. 5896-104)
- 10 x straight tube connectors 5mm (Art.-No. 5896-105)
- 10 x straight tube connectors 6mm (Art.-No. 5896-106)
- 10 x T-hose connector 3mm (Art.-No. 5896-203)
- 10 x T-tube connector 4mm (Art.-No. 5896-204)
- 10 x T-tube connector 5mm (Art.-No. 5896-205)
- 10 x T-hose connector 6mm (Art.-No. 5896-206)
- 10 x angled hose connectors 3mm (Art.-No. 5896-303)
- 10 x angled hose connectors 4mm (Art.-No. 5896-304)
- 10 x angled hose connectors 5mm (Art.-No. 5896-305)
- 10 x angled hose connectors 6mm (Art.-No. 5896-306)
- 10 x Y-hose connector 3mm (Art.-No. 5896-403)
- 10 x Y-hose connector 4mm (Art.-No. 5896-404)
- 10 x Y-tube connector 5mm (Art.-No. 5896-405)
- 10 x Y-hose connector 6mm (art.-no. 5896-406)





01

**Copper sealing ring DIN 7603 A**  
solid



Item No.	Thickness [mm]	Inside-Ø [mm]	Outside Ø [mm]	PU
6460-5-9	1,0	5	9	100
6460-6-10	1,0	6	10	100
6460-6-12	1,0	6	12	100
6460-8-12	1,0	8	12	100
6460-8-14	1,0	8	14	100
6460-10-12	1,0	10	12	100
6460-10-14	1,0	10	14	100
6460-10-16	1,5	10	16	100
6460-10-18	1,5	10	18	100
6460-12-16	1,5	12	16	100
6460-12-18	1,5	12	18	100
6460-14-18	1,5	14	18	100
6460-14-20	1,5	14	20	100
6460-14-22	1,5	14	22	100
6460-16-20	1,5	16	20	100
6460-16-22	1,5	16	22	100
6460-16-24	1,5	16	24	100
6460-18-22	1,5	18	22	100
6460-18-24	1,5	18	24	100
6460-20-24	1,5	20	24	100
6460-20-26	1,5	20	26	100
6460-22-27	1,5	22	27	100
6460-22-29	1,5	22	29	100
6460-24-30	2,0	24	30	50
6460-24-32	2,0	24	32	100
6460-26-32	2,0	26	32	50
6460-26-34	2,0	26	34	100
6460-27-32	2,0	27	32	50
6460-28-34	2,0	28	34	100
6460-30-36	2,0	30	36	50
6460-32-38	2,0	32	38	100
6460-36-42	2,0	36	42	100



02

**Copper sealing rings assortment DIN 7603A**  
1,190-part

► Item no. 1957-460

► Content:

- Contents: 1,190 parts
- 100 x copper sealing rings 6 x 10 x 1 (item no. 6460-6-10)
- 100 x copper sealing rings 8 x 12 x 1 (item no.6460-8-12)
- 100 x copper sealing rings 8 x 14 x 1 (item no.6460-8-14)
- 100 x copper sealing rings 10 x 14 x 1 (item no.6460-10-14)
- 100 x copper sealing rings 10 x 16 x 1 (item no. 6460-10-16)
- 100 x copper sealing rings 12 x 16 x 1.5 (item no.6460-12-16)
- 100 x copper sealing rings 12 x 18 x 1.5 (item no.6460-12-18)
- 50 x copper sealing rings 14 x 18 x 1.5 (item no.6460-14-18)
- 50 x copper sealing rings 14 x 20 x 1.5 (item no. 6460-14-20)
- 50 x copper sealing rings 14 x 22 x 1.5 (item no.6460-14-22)
- 50 x copper sealing rings 16 x 22 x 1.5 (item no.6460-16-22)
- 50 x copper sealing rings 18 x 24 x 1.5 (item no.6460-18-24)
- 50 x copper sealing rings 20 x 26 x 1.5 (item no.6460-20-26)
- 50 x copper sealing rings 22 x 27 x 1.5 (item no.6460-22-27)
- 50 x copper sealing rings 22 x 29 x 1.5 (item no.6460-22-29)
- 30 x copper sealing rings 24 x 30 x 2 (item no. 6460-24-30)
- 30 x copper sealing rings 26 x 32 x 2 (item no.6460-26-32)
- 30 x copper sealing rings 28 x 34 x 2 (item no.6460-28-34)



01

**Aluminum sealing ring DIN 7603**

Shape A



Item No.	Thickness [mm]	Inside-Ø [mm]	Outside Ø [mm]	PU
6463-6-10	1,0	6	10	100
6463-8-12	1,0	8	12	100
6463-8-14	1,0	8	14	100
6463-10-14	1,0	10	14	100
6463-10-16	1,0	10	16	100
6463-12-16	1,0	12	16	100
6463-12-18	1,5	12	18	100
6463-14-18	1,5	14	18	100
6463-14-20	1,5	14	20	100
6464-114-22	2,0	14	22	50
6463-16-20	1,5	16	20	100
6463-16-22	1,5	16	22	100
6463-18-22	1,5	18	22	100
6463-18-24	1,5	18	24	100
6463-20-26	1,5	20	26	100
6463-22-27	1,5	22	27	100
6463-24-30	2,0	24	30	100
6463-26-32	2,0	26	32	100

02

**Copper filler seal DIN 7603**

Form C



Item No.	Thickness [mm]	Inside-Ø [mm]	Outside Ø [mm]	PU
6462-12-18	2,0	12	18	100
6462-14-20	2,0	14	20	100
6462-14-21	2,0	14	21	100
6462-14-22	2,0	14	22	100
6462-16-20	2,0	16	20	100
6462-16-22	2,0	16	22	100
6462-18-24	2,0	18	24	100

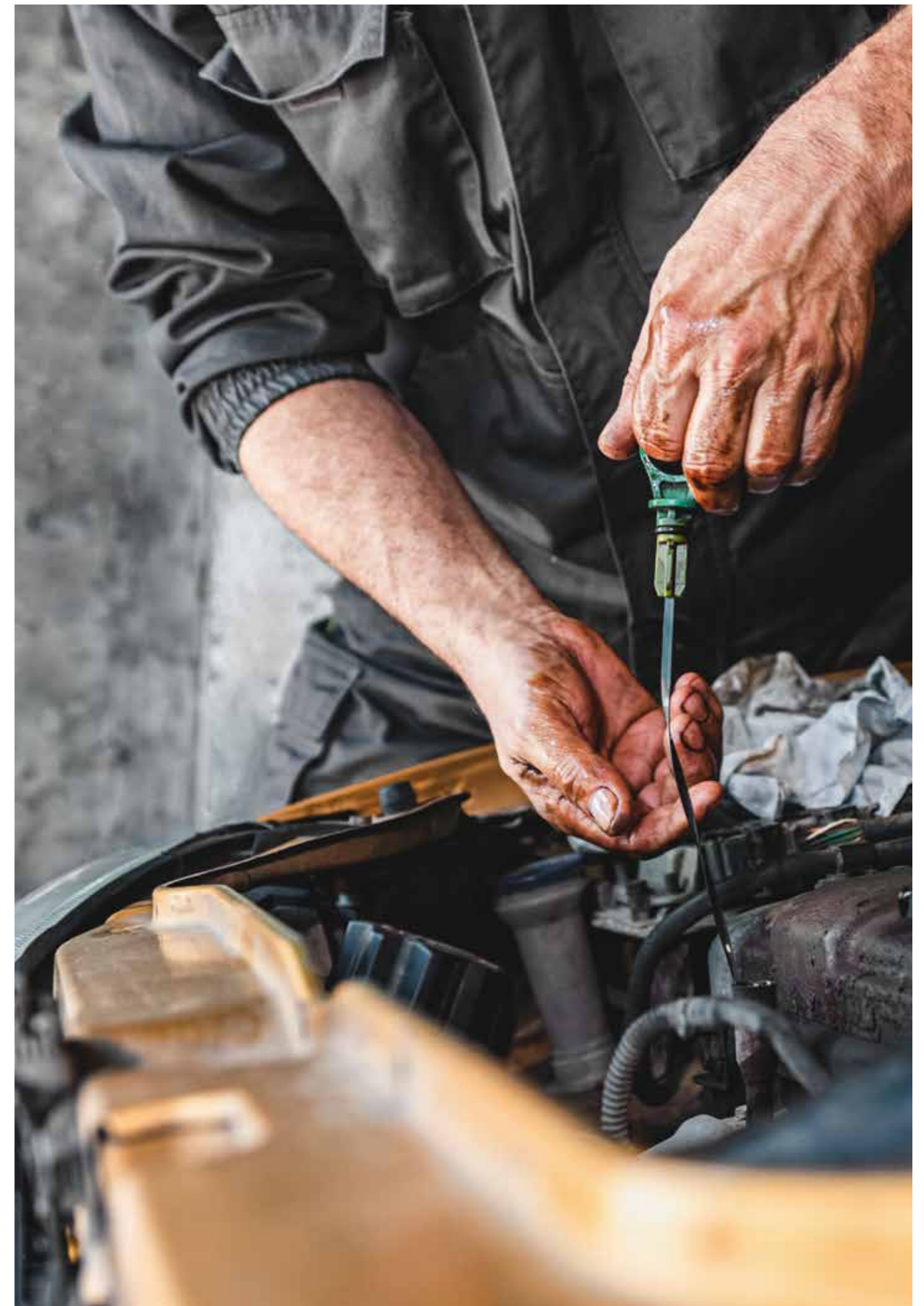



**Screw plugs universal**

Item No.	Dimensions	execution	Original no.	PU	image
6241-12-15	M12 x 1.5 x 12 mm	Screw plug DIN 910 galvanized	29973430	10	
6241-14-15		Screw plug DIN 910 galvanized		10	
6241-16-15		Screw plug DIN 910 galvanized		10	
6241-18-15		Screw plug DIN 910 galvanized		10	
6241-22-15		Screw plug DIN 910 galvanized		10	

**Alfa Romeo**

Item No.	Dimensions	execution	Original no.	PU	image
6242-18-15	M18 x 1.5 x 12 mm	Screw		10	
6460-18-24	18 x 24 x 1.5 mm	Gasket ring	55196309	100	

**Audi**

Item No.	Dimensions	execution	Original no.	PU	image
6242-014-15	M14 x 1.5 x 12 mm	Screw	652475	10	
6460-14-20	14 x 20 x 1.5 mm	Gasket ring		100	
6240-14-151	M14 x 1.5 x 17.5 mm	Screw		10	
6460-14-20	14 x 20 x 1.5 mm	Gasket ring		100	
6243-14-161	M14 x 1.5 x 22 mm	Screw Ø including sealing ring		10	

**BMW**

Item No.	Dimensions	execution	Original no.	PU	image
6243-12-15	M12 x 1.5 x 18 mm	Screw	11131273093	10	
6463-12-18	12 x 17 x 1.5 mm	Gasket ring		100	
6464-022-015	22 x 27 x 1.5 mm	Gasket ring		100	
6241-12-15	M12 x 1.5 x 12 mm	Screw plug DIN 910 galvanized	29973430	10	
6463-12-18	12 x 17 x 1.5 mm	Gasket ring		100	
6243-30-4		Plastic, including sealing ring	simil. 11137605018	10	

**Citroën**

Item No.	Dimensions	execution	Original no.	PU	image
6242-16-15	16 mm	Screw		10	
6462-16-22	16 x 22 x 2.0	Gasket ring		100	
6464-016-724	16.7 x 24 x 1.5 mm	Gasket ring		50	

**Daewoo**

Item No.	Dimensions	execution	Original no.	PU	image
6460-14-20	14 x 20 x 1.5 mm	Gasket ring		100	

**Daihatsu**

Item No.	Dimensions	execution	Original no.	PU	image
6460-14-20	14 x 20 x 1.5 mm	Gasket ring		100	

**Fiat**

Item No.	Dimensions	execution	Original no.	PU	image
6243-22-015			16993411/ 503633291	25	

**ford**

Item No.	Dimensions	execution	Original no.	PU	image
6243-30-3	30 x 3.0 mm	Sealing ring Ø		10	
6243-30-5		Screw incl. sealing ring		10	
6243-30-2		Ø plastic, including sealing ring		10	
6243-30-6		Gasket ring		10	
6243-14-15	M14 x 1.5 x 16 mm	Screw		25	
6243-014-15	M14 x 1.5 x 16 mm	Screw yellow gv	1454117/6732529	10	
6464-16-24	16.7 x 24 x 2 mm	Sealing ring yellow gv		100	
6464-14-22	14 x 22 x 2 mm	Gasket ring	1454118	100	
6243-14-159	M14 x 1.5 x 21 mm	Screw		10	

**ford**

6464-128-225	13 x 22.5 x 3 mm	Gasket ring		50	
6243-012-15	M12 x 1.75 x 28.5 mm	Screw incl. sealing ring	3051079	1	

**Honda**

Item No.	Dimensions	execution	Original no.	PU	image
6464-114-22	14 x 22 x mm	Gasket ring		50	

**Hyundai**

Item No.	Dimensions	execution	Original no.	PU	image
6464-14-19	14 x 19 x 2.2 mm	Gasket ring	MD050317	50	

**jaguar**



Item No.	Dimensions	execution	Original no.	PU	image
6243-14-159	M14 x 1.5 x 21 mm	Screw		10	
6464-128-225	13 x 22.5 x 3 mm	Gasket ring		50	

**Kia**

Item No.	Dimensions	execution	Original no.	PU	image
6464-14-19	14 x 19 x 2.2 mm	Gasket ring	MD050317	50	







**Land Rover**

Item No.	Dimensions	execution	Original no.	PU	image
6243-14-15	M14 x 1.5 x 16 mm	Screw		25	
6243-014-15	M14 x 1.5 x 16 mm	Screw Ø yellow gv	1454117/6732529	10	
6464-16-24	16.7 x 24 x 2 mm	Ø sealing ring yellow gv		100	

**Mazda**

Item No.	Dimensions	execution	Original no.	PU	image
6460-14-20	14 x 20 x 1.5 mm	Gasket ring		100	

**Mercedes Benz**

Item No.	Dimensions	execution	Original no.	PU	image
6243-30-7			57233	5	
6242-14-15	M14 x 1.5 x 24 mm	Screw	6019970230	10	
6460-14-20	14 x 20 x 1.5 mm	Gasket ring		100	
6241-12-15	M12 x 1.5 x 12 mm	Screw plug DIN 910 galvanized	29973430	10	
6464-014-15	12 x 17 x 1.5 mm	Gasket ring		100	

**Mitsubishi**

Item No.	Dimensions	execution	Original no.	PU	image
6464-14-19	14 x 19 x 2.2 mm	Gasket ring	MD050317	50	

**Mini**

Item No.	Dimensions	execution	Original no.	PU	image
6242-12-15	M14 x 1.5 x 20 mm	Screw including sealing ring	11137513050	1	

**Nissan**

Item No.	Dimensions	execution	Original no.	PU	image
6464-11-17	12 x 17 x 3 mm	Gasket ring	1102601M02	50	

**Peugeot**

Item No.	Dimensions	execution	Original no.	PU	image
6243-10-22	M10 x 1.25 x 13 mm	Screw	311.29	10	
6464-10-10	10.5 x 20.5 x 2 mm	Gasket ring	0313.33	100	
6243-018-22	M18 x 1.5 x 16 mm	Screw	770305077	10	
6462-18-24	M18 x 24 x 2.0	Gasket ring		100	
6243-014-22	M14 x 1.5 x 12.5 mm	Screw		10	
6462-14-21	14 x 21 x 2.0	Gasket ring		100	

Opel					
Item No.	Dimensions	execution	Original no.	PU	image
6464-11-19		Gasket ring		25	
6243-12-175		Screw		10	
6242-014-15	M14 x 1.5 x 12 mm	Screw	652475	10	
6460-14-20	14 x 20 x 1.5 mm	Gasket ring		100	
6243-14-160	M14 x 1.5 x 10.5 mm	Screw	90502556/ 96023264	10	
6464-18-2	18 x 22 x 2 mm	Gasket ring	652540/ 90528145	100	
6243-12-160	M12 x 1.75 x 25 mm	Screw	652736/ 652454	10	
6464-011-212	11 x 21 x 2.5 mm	Gasket ring		100	
6243-18-15	M18 x 1.5 x 21 mm	Screw		10	
6464-185-26	18,5 x 26 x 2.5 mm	Gasket ring		50	
6243-22-015			16993411/ 503633291	25	

Porsche					
Item No.	Dimensions	execution	Original no.	PU	image
6460-22-27	22 x 27 x 1.5 mm	Gasket ring		100	

Renault					
Item No.	Dimensions	execution	Original no.	PU	image
6243-016-22	M16 x 1.5 x 13 mm	Screw	7903075033	10	
6462-16-22	16 x 22 x 2.0	Gasket ring		100	
6243-160-22	M16 x 1.5 x 20.5 mm	Screw with magnet	7703075012	10	
6243-018-22	M18 x 1.5 x 16 mm	Screw	770305077	10	
6462-18-24	M18 x 24 x 2.0	Gasket ring		100	

rover					
Item No.	Dimensions	execution	Original no.	PU	image
6243-12-15	M12 x 1.5 x 18 mm	Screw	11131273093	10	
6463-12-18	12 x 17 x 1.5 mm	Gasket ring		100	

Saab					
Item No.	Dimensions	execution	Original no.	PU	image
6243-014-15	M14 x 1.5 x 16 mm	Screw yellow gv	1454117/6732529	10	
6464-15-15	15 x 24 x 2 mm	Gasket ring	109132937	100	
6243-14-15	M14 x 1.5 x 16 mm	Screw		25	



Seat					
Item No.	Dimensions	execution	Original no.	PU	image
6460-22-27	22 x 27 x 1.5 mm	Gasket ring		100	
6243-14-161	M14 x 1.5 x 22 mm	incl. sealing ring	N90813201	10	

Skoda					
Item No.	Dimensions	execution	Original no.	PU	image
6242-014-15	M14 x 1.5 x 12 mm	Screw	652475	10	
6460-14-20	14 x 20 x 1.5 mm	Gasket ring		100	
6243-14-161	M14 x 1.5 x 22 mm	Screw Ø including sealing ring		10	

Subaru					
Item No.	Dimensions	execution	Original no.	PU	image
6464-20-15	20 x 26 x 2 mm	Gasket ring	11126AA000	100	

Suzuki					
Item No.	Dimensions	execution	Original no.	PU	image
6460-14-20	14 x 20 x 1.5 mm	Gasket ring		100	

Toyota					
Item No.	Dimensions	execution	Original no.	PU	image
6464-012-242	12 x 24 x 2 mm	Gasket ring	90430-12028	50	

VW					
Item No.	Dimensions	execution	Original no.	PU	image
6243-14-015	M x 1,5 mm	Screw	N90288901	25	
6242-014-15	M14 x 1.5 x 12 mm	Screw	652475	10	
6460-14-20	14 x 20 x 1.5 mm	Gasket ring		100	
6240-14-151	M14 x 1.5 x 17.5 mm	Screw		10	
6460-14-20	14 x 20 x 1.5 mm	Gasket ring		100	
6243-14-161	M14 x 1.5 x 22 mm	incl. sealing ring		10	
6243-30-1	M14 x 1,5 x 22 mm	Plastic, including sealing ring	06L103801	10	

Volvo					
Item No.	Dimensions	execution	Original no.	PU	image
6463-18-24	18 x 24 x 1.5 mm	Gasket ring		100	



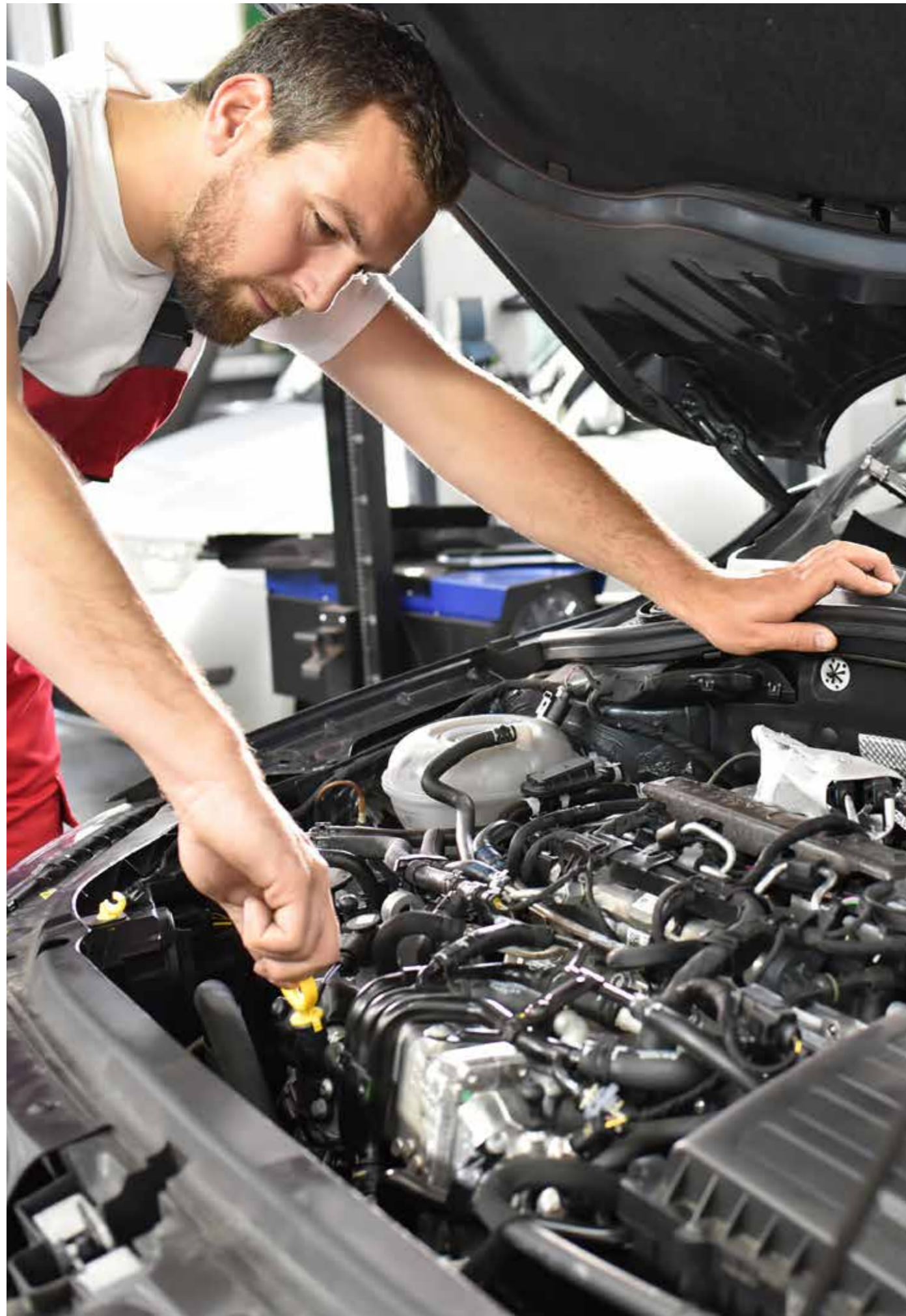

01

**Sealing rings for oil drain plug assortment**

1,000-piece

► Item no. 1957-462

► Content:

- Contents: 1,000 parts
- 100 x copper sealing ring form A 12 x 18 x 1.5 (item no.6460-12-18)
- 100 x copper sealing ring form A 14 x 20 x 1.5 (item no.6460-14-20)
- 100 x copper sealing ring form C 14 x 21 x 2 (item no. 6462-14-21)
- 100 x copper sealing ring form C 16 x 22 x 2 (item no. 6462-16-22)
- 100 x copper sealing ring form C 18 x 24 x 2 (item no. 6462-18-24)
- 100 x aluminum sealing ring form A 12 x 17 x 1.5 (item no. 6463-12-18)
- 50 x Toyota sealing ring NF231 12 x 24 x 2 (item no. 6464-012-242)
- 50 x Nissan folding rings 11 x 17 x 3 (item no. 6464-11-17)
- 50 x Ford seal NBR 70 12.8 x 22.5 x 3 (item no. 6464-128-225)
- 100 x plastic sealing ring PA6 14.5 x 22 x 2 (item no. 6464-14-22)
- 50 x Ford sealing ring 16.7 x 24 x 2 large lips (item no. 6464-16-24)
- 100 x sealing ring Opel NBR 70 18 x 22 x 2 (item no. 6464-18-2)



01  
**Perbunan O-rings**  
 metric



Item No.	Inside-Ø [mm]	Ring thickness [mm]	PU
6468-003-20	3	2,0	50
6468-004-20	4	2,0	50
6468-005-20	5	2,0	50
6468-006-20	6	2,0	50
6468-007-20	7	2,0	50
6468-008-20	8	2,0	50
6468-010-20	10	2,0	50
6468-010-25	10	2,5	50
6468-012-20	12	2,0	50
6468-012-25	12	2,5	50
6468-014-25	14	2,5	50
6468-015-25	15	2,5	50
6468-017-25	17	2,5	25
6468-018-30	18	3,0	25
6468-019-25	19	2,5	25
6468-020-30	20	3,0	25
6468-022-30	22	3,0	25
6468-024-30	24	3,0	25
6468-025-30	25	3,0	25
6468-028-30	28	3,0	25
6468-030-30	30	3,0	25
6468-034-30	34	3,0	25
6468-035-35	35	3,5	25
6468-036-30	36	3,0	25
6468-038-30	38	3,0	25



02  
**O-rings assortment Perbunan**  
 1,050-part

► Item no. 1957-468-1

► Content:

- Contents: 1,050 parts
- 100 x O-rings made of Perbunan 3.00 x 2.00 (Item No. 6468-003-20)
- 100 x O-rings made of Perbunan 4.00 x 2.00 (Item No. 6468-004-20)
- 100 x O-rings made of Perbunan 5.00 x 2.00 (Item No. 6468-005-20)
- 100 x O-rings made of Perbunan 6.00 x 2.00 (Item No. 6468-006-20)
- 100 x O-rings made of Perbunan 7.00 x 2.00 (Item No. 6468-007-20)
- 100 x O-rings made of Perbunan 8.00 x 2.00 (Item No. 6468-008-20)
- 50 x O-rings made of Perbunan 10.00 x 2.00 (Item No. 6468-010-20)
- 50 x O-rings made of Perbunan 10.00 x 2.50 (item no. 6468-010-25)
- 50 x O-rings made of Perbunan 12.00 x 2.00 (Item No. 6468-012-20)
- 50 x O-rings made of Perbunan 12.00 x 2.50 (Item No. 6468-012-25)
- 50 x O-rings made of Perbunan 14.00 x 2.50 (item no. 6468-014-25)
- 50 x O-rings made of Perbunan 15.00 x 2.50 (item no. 6468-015-25)
- 25 x O-rings made of Perbunan 17.00 x 2.50 (Item No. 6468-017-25)
- 25 x O-rings made of Perbunan 18.00 x 3.00 (Item No. 6468-018-30)
- 25 x O-rings made of Perbunan 19.00 x 2.50 (Item No. 6468-019-25)
- 25 x O-rings made of Perbunan 20.00 x 3.00 (Item No. 6468-020-30)
- 25 x O-rings made of Perbunan 22.00 x 3.00 (Item No. 6468-022-30)
- 25 x O-rings made of Perbunan 24.00 x 3.00 (Item No. 6468-024-30)

01

**Axle boot set, universal**

suitable for all cars

► Item no. 5884-900

► Technical specifications

- for assembly without dismantling the cardan and axle joints
- suitable for all cars
- oil and grease resistant
- Suitable for all common front and rear wheel cardan joints
- at the narrowest point the axle sleeve has a diameter of approx. 21 mm
- 
- Scope of delivery:
  - 1 x universal axle boot
  - 1 x universal hose clamp, large
  - 1 x universal hose clamp, small
  - 1 x high temperature joint fat



02

**Axle boot set, universal**

Suitable for all cars and vans up to 3.5 t

► Item no. 5884-901

► Technical specifications

- for assembly without dismantling the cardan and axle joints
- Suitable for all cars and vans up to 3.5 t
- oil and grease resistant
- Suitable for all common front and rear wheel cardan joints
- 
- Scope of delivery:
  - 1 x universal axle boot
  - 1 x universal hose clamp, large
  - 1 x universal hose clamp, small
  - 1 x high temperature joint fat



04

**Clamps for axle boots**

Item No.	Ø mm	PU
5550-884-31	31	25
5550-884-33	33	25
5550-884-35	35	25
5550-884-88	88	25
5550-884-97	97	25



05

**Steel cable ties**

6 x 380 mm

► Item no. 5884-909

► PU: 25

► Technical specifications

- for diameters from 60 mm to 120 mm



06

**Steel cable ties**

self-locking

Item No.	Bandwidth	length	PU
5550-46-127	4,6 mm	127 mm	25
5550-46-201	4,6 mm	201 mm	25
5550-46-360	4,6 mm	360 mm	50
5550-46-521	4,6 mm	521 mm	20
5550-79-201	7,9 mm	201 mm	25
5550-79-362	7,9 mm	362 mm	50







02

**Oil binder**

Oil-Catcher Premium Protect



- ▶ Item no. 7874-150-1
- ▶ Content: 1 litre
- ▶ PU: 1

- ▶ Item no. 7874-150
- ▶ Content: 50 litres
- ▶ PU: 1

▶ **Technical specifications**

- rapid absorption of oils, chemicals, fuels, paints and much more.
- for outdoor and indoor use
- organic binder
- universally applicable
- Basis: natural fiber
- pH value: 3.8
- applicable under all conditions
- reusable until saturation is reached
- non-toxic for humans, animals and the environment
- can be used on any surface
- economical and easy to use
- easy to dispose of
- no sustainable pollution of soil, water or groundwater
- no long-term physical or visual effect on the environment



Oil-Catcher Premium is an organic binder that quickly and effectively absorbs oils, fuels, chemicals, lubricants, emulsions, paints, solvents, coolants and other synthetic and mineral oil-containing liquids. The product can be used universally on water, asphalt and soil to combat contamination. The organic fiber is non-toxic, has no negative impact on the environment and can be easily disposed of after use. Oil-Catcher Premium is already effective after 1 to 2 seconds and binds up to 8 times its own weight! With a volume of only 120g / liter, Oil-Catcher Premium is extremely light, economical and easy to use.

Oil-Catcher Premium meets the requirements for oil binders of the Federal Ministry for the Environment and Nature Conservation Germany for TYPE I waters, TYPE II soil, TYPE III trade and industry, TYPE R roads and traffic areas.





01

**Disposable protective covers Clean-Set**  
for passenger car

- ▶ Item no. 7410-003-009
- ▶ PU: 100
  
- ▶ Set consisting of:
  - 1x seat protector 135 x 82cm, PE white
  - 1x Footwell protector 38 x 50cm, film-coated paper, non-slip, waterproof
  - 1x Steering wheel cover 40 cm, with elastic band, PE white
  - 1x Gear lever cover with elastic band
  - 1x handbrake protector without rubber band
- each set in a bag
- 100 sets per dispenser box



02

**Disposable protective covers as a compact 5in1 roll**  
recyclable

- ▶ Item no. 7875-919
- ▶ VPE: 1
  
- ▶ Technical specifications
  - 100% recyclable
  - Made from at least 50% recycled material
  - 200 sets
  - Set consisting of:
    - Slipcover
    - Doormat
    - Steering wheel protection
    - Gear lever protection
    - Handbrake protection



03

**Front protector**

- ▶ Item no. 7410-003-013
  
- ▶ Technical specifications
  - All-round protection when working in the engine compartment
  - with adjustable Velcro straps for attachment to the exterior mirrors
  - With removable, non-slip, washable padding in the fender area
  - Size variable through elastic band
  - suitable for all common vehicle manufacturers
  - large fold-out flaps that also securely cover large fenders



04

**Fender protector**  
made of polyester

- ▶ Item no. 7875-921-8
  
- ▶ Technical specifications
  - with magnet
  - 100 cm x 65 cm
  - with two tool bags



05

**Fender protector**  
made of synthetic leather

- ▶ Item no. 7875-921-9
  
- ▶ Technical specifications
  - with magnet
  - 100 cm x 65 cm



01

**Disposable steering wheel protector**  
for passenger car

- ▶ Item no. 7410-003-014
- ▶ PU: 250

- ▶ Technical specifications
- For steering wheels with a maximum diameter of 40 cm
- with two rubber bands
- in the removal box
- 20 m $\mu$



02

**Disposable steering wheel protector**  
for trucks

- ▶ Item no. 7410-003-019
- ▶ PU: 250

- ▶ Technical specifications
- PE film with elastic band
- Diameter: 55 cm
- PU: 250 pieces
- Thickness: 20 $\mu$
- Color white



03

**Steering wheel protector roll**  
universal

- ▶ Item no. 7875-900
- ▶ Technical specifications
- Length: 300 m
- Width: 14 cm
- Inner core  $\varnothing$ : 3.8 cm



04

**Handle for steering wheel protector roll**

- ▶ Item no. 7875-900-01



05

**Disposable doormats**  
with NORMFEST logo

- ▶ Item no. 7875-510
- ▶ PU: 1
- ▶ Content: Roll each with 500 pcs.

- ▶ Technical specifications
- 38 x 50 cm
- 70g / m $^2$



06

**Duo-mat floor mats**  
universal

- ▶ Item no. 7875-511
- ▶ Content: 500 pcs. in a carton

- ▶ Technical specifications
- no seepage of liquids and oils
- high tear resistance thanks to the laminated, antistatic film
- 38 x 50 cm
- Paper: 70 g gray

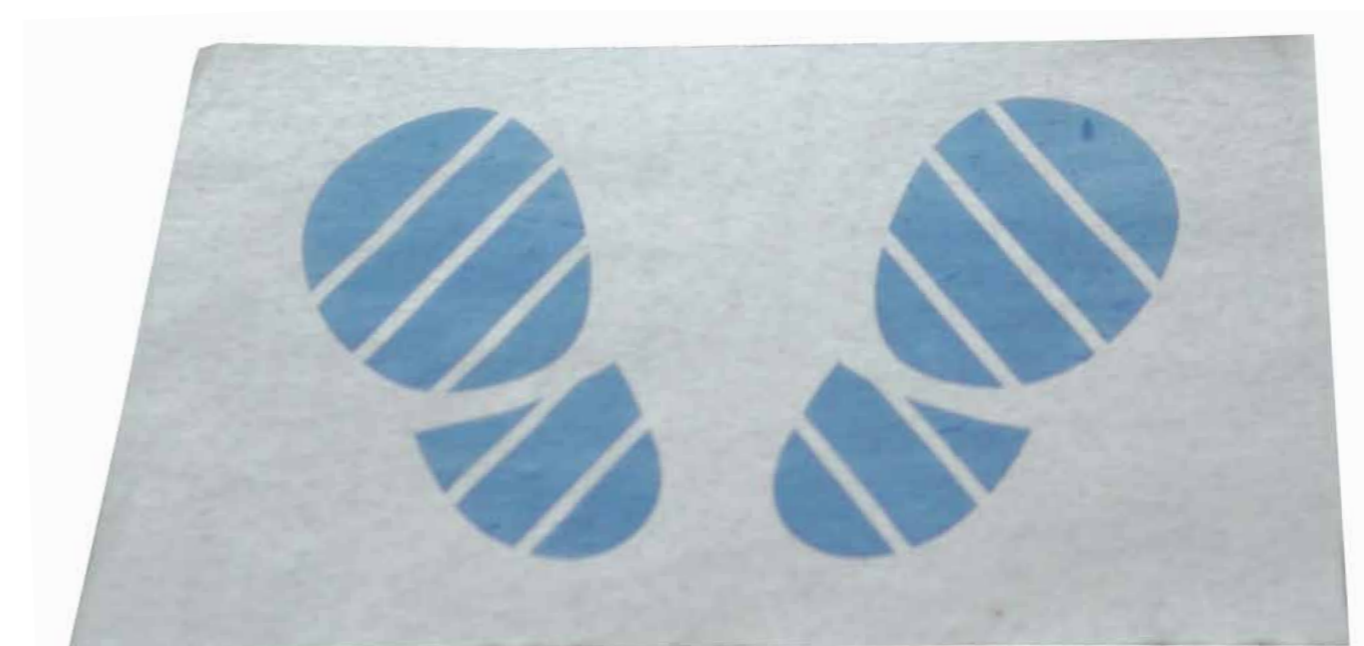



01

**Seat cover**

made of nylon

- ▶ Item no. 7875-920-1
- ▶ Technical specifications
  - 160 x 80 cm
  - Washable up to 50 ° C
  - 120 g per piece



02

**Seat cover**

made of synthetic leather

- ▶ Item no. 7875-920-000
- ▶ Technical specifications
  - approved for seats with airbag function
  - leatherette
  - Washable up to 40 ° C
  - Not suitable for light leather seats!



03

**Seat covers**

Color white

- ▶ Item no. 7875-904
- ▶ Content: Roll each with 100 pcs.
- ▶ Item no. 7875-902
- ▶ Content: Roll each with 500 pcs.
- ▶ Technical specifications
  - Dimensions: 82cm x 130cm
  - Thickness: 13μ
  - Roll of 100 pieces
  - perforated



04

**Seat covers**

permanently antistatic

- ▶ Item no. 7875-905
- ▶ Content: Roll each with 250 pcs.
- ▶ Technical specifications
  - Dimensions: 840 x 1400mm
  - Thickness: 17μ
  - 250 pieces per roll
  - permanently antistatic
  - approved for Daimler







Bodywork repair





01  
**Multipurpose primer**  
1K multi-connector

- ▶ Item no. 2893-900
- ▶ colour: light grey
- ▶ Content: 400 ml
- ▶ Quantity per box: 12



- ▶ Item no. 2893-900-20
- ▶ colour: dark grey
- ▶ Content: 400 ml
- ▶ Quantity per box: 12



- ▶ **Technical specifications**
- very good adhesion promoter and rust protection spray in one
- is ideal as a primer on galvanized surfaces, aluminum, steel, various plastics and wood
- after a skin has formed, it can be painted over "wet on wet" without intermediate sanding
- has a good filling capacity and thus compensates for slight unevenness
- Can be painted over without intermediate sanding
- with fan spray head
- Insulates the edge zones of putty spots particularly well



02  
**Primer with rust stop function**  
1K Epoxy

- ▶ Item no. 2893-907-2
- ▶ colour: white
- ▶ Content: 400 ml
- ▶ Quantity per box: 6



- ▶ Item no. 2893-907
- ▶ colour: grey
- ▶ Content: Starter Set
- ▶ Quantity per box: 6



- ▶ Item no. 2893-907-1
- ▶ colour: for 1001-179-6
- ▶ Content: 400 ml
- ▶ Quantity per box: 6



- ▶ **Technical specifications**
- good adhesive properties on all metals, various plastics and GRP
- excellent rust protection properties
- high opacity
- fast drying
- wet on wet application under filler
- sandable after 20 min
- Can be painted over with all commercially available 1K and 2K solvent and water-based top coats
- Epoxy based and silicone remover resistant
- temperature resistant up to 95 ° C
- especially for small damage repairs up to spot repairs
- Insulating effect against moisture
- high paint application rate
- constant atomizer pressure until the can is emptied
- professional painting result
- very high filling capacity due to 23.1% solids content
- according to DIN53150



01

**Basic primer**

Baso Plus

- ▶ Item no. 2893-889
- ▶ colour: light grey
- ▶ Content: 400 ml
- ▶ Quantity per box: 24

▶ **Technical specifications**

- high filling capacity
- contains an anti-rust agent
- is very suitable for priming iron surfaces
- temperature resistant up to 100 ° C
- Can be painted over with nitro, acrylic and water-based paint
- Fan spray head enables vertical and horizontal application of the primer
- do not paint on surfaces painted with synthetic resin



02

**Rust-stop primer**

Rednox

- ▶ Item no. 2893-888
- ▶ colour: RAL 8012 auburn
- ▶ Content: 400 ml
- ▶ Quantity per box: 12

▶ **Technical specifications**

- fast drying
- weldable
- can be painted over
- sprayable

03

**Rust converter**

Rostinator

- ▶ Item no. 2893-903
- ▶ Content: 400 ml
- ▶ Quantity per box: 12

▶ **Technical specifications**

- converts rust into iron sulfide using active pigments
- forms a permanent weather- and moisture-resistant protective seal
- Drying time: 14 hours
- Compatible with all Normfest primers

04

**Thick film filler**

1K filler

- ▶ Item no. 2893-902-1
- ▶ Content: 400 ml
- ▶ Quantity per box: 6

▶ **Technical specifications**

- high solids content
- good corrosion protection thanks to active rust protection pigments
- good adhesive properties on steel, galvanized steel, aluminum and various plastics such as hard PVC, PPO / PA, ABS, PC / PBT
- excellent filling capacity
- very high stability
- quick-drying (dust-dry: 3min, touch-proof: 8min and sandable: 20min)
- 30 µm layer thickness can be sanded dry after 20 minutes at 20 degrees Celsius
- Can be painted over with commercially available 1K and 2K solvent- and water-based topcoats
- temperature resistant up to approx. 90 ° C
- In any case, check for compatibility
- Equipped with a round jet nozzle (spray pattern analogous to the paint gun)





01  
**2 component primer filler**  
2K Rapid Filler

- ▶ Item no. 2893-905
- ▶ Content: 400 ml
- ▶ Quantity per box: 6
  
- ▶ Technical specifications
- isocyanate free
- very fast drying after 1 hour at 20 ° C
- or after 15-20 minutes at 60 ° C
- Can be painted over: after 20 minutes air drying
- Can be sanded after 1 hour at 20 ° C or 30 minutes at 60 ° C
- Universally applicable on sanded old paintwork and metallic surfaces
- simple, time-saving processing
- very high filling capacity
- very good adhesion to bare steel / sheet metal
- Can be painted over with all common 1K and 2K topcoat systems

02  
**Primer filler**  
2K epoxy

- ▶ Item no. 2800-760
- ▶ colour: beige
- ▶ Content: 400 ml
- ▶ Quantity per box: 6
  
- ▶ Technical specifications
- Degree of gloss: matt
- Color beige
- Long-lasting corrosion protection on all surfaces, e.g. zinc, aluminum, steel, etc.
- Solids content: 50-53% by weight based on diluted paint (without propellant)



03  
**Zinc primer**  
Galva 97

- ▶ Item no. 2893-880
- ▶ Content: 400 ml
- ▶ Quantity per box: 12
  
- ▶ Technical specifications
- weatherproof
- fast drying
- high solids content
- scratch-resistant
- easy processing
- good course
- protects new sheets from rusting
- weldable
- Abrasion-resistant after drying
- high corrosion protection
- high proportion of active ingredients

04  
**Zinc-aluminum primer**  
Galva 97 Silver

- ▶ Item no. 2893-890
- ▶ Content: 400 ml
- ▶ Quantity per box: 12
  
- ▶ Technical specifications
- ideal for aligning galvanized sheets
- protects new sheets from rusting
- temperature resistant up to 500 ° C
- weldable
- Abrasion-resistant after drying
- high corrosion protection
- high proportion of active ingredients



01

**Aluminum primer**

Alloy

- ▶ Item no. 2893-881
- ▶ Content: 400 ml
- ▶ Quantity per box: 12

▶ **Technical specifications**

- heat-resistant corrosion protection up to 600 ° C
- weldable
- can be painted over
- protects new sheets from rusting

02

**Pistol grip**

for spray cans

- ▶ Item no. 2893-900-2
- ▶ PU: 1



03

**Fan nozzle**

for spray cans

- ▶ Item no. 2893-900-3
- ▶ PU: 12



04

**Sealing cap**

for used aerosol cans

- ▶ Item no. 2897-999
- ▶ PU: 10



05

**Welding primer**

Elox Plus

- ▶ Item no. 2893-906
- ▶ Content: 400 ml
- ▶ Quantity per box: 12

▶ **Technical specifications**

- 1K acrylic base
- very good corrosion protection
- easy to weld over
- very good ignitability

06

**Welding protection spray**

Antilox Protect

- ▶ Item no. 2893-908
- ▶ Content: 400 ml
- ▶ Quantity per box: 12

▶ **Technical specifications**

- to protect against adhesion of weld spatter
- for inert gas welding work on steel, aluminum and stainless steel
- silicone-free and therefore suitable for painters
- does not affect the weld seam
- very economical and productive





01

**Underbody protection can be painted over**

Bottom Guard Recoat

- ▶ Item no. 2892-881
- ▶ Farbe: black
- ▶ Content: 500 ml
- ▶ Quantity per box: 12
  
- ▶ Item no. 2892-882
- ▶ Farbe: black
- ▶ Content: 1000 ml
- ▶ Quantity per box: 12
  
- ▶ Item no. 2892-883
- ▶ Farbe: grey
- ▶ Content: 1000 ml
- ▶ Quantity per box: 12



- ▶ **Technical specifications**
- offers optimized underbody protection with anti-rust and corrosion protection properties
- contributes to improved sound insulation
- Anti-rust spray dries quickly and is extremely abrasion-resistant
- has very good adhesion to all surfaces such as bumpers / front and rear aprons
- After 60-90 minutes, the underbody spray can be painted over with two-component and basecoats



02

**Water-based underbody protection can be painted over**

Bottom Guard Protect



- ▶ Item no. 2892-995
- ▶ Farbe: dark grey
- ▶ Content: 1000 ml
- ▶ Quantity per box: 12



- ▶ **Technical specifications**
- dark gray
- water based
- fast drying
- with corrosion protection
- Can be painted over with conventional 2K acrylic paints, basecoats and water-based paints
- Can be sanded after drying
- extremely elastic and resistant after hardening
- Temperature resistant from -25 ° C to 120 ° C
- low odor
- Touch dry (20 ° C, 65% RH) approx. 90-120 minutes
- fully cured per layer thickness at (20 ° C, 65% RH) approx. 7 days





01

**Wax-based underbody protection**

**Bottom Guard Wax**

- ▶ Item no. 2892-994-3
- ▶ Farbe: transparent
- ▶ Content: 500 ml
- ▶ Quantity per box: 12



▶ **Technical specifications**

- transparent
- Corrosion protection even with a thin layer of material
- high creeping ability

- ▶ Item no. 2892-994-2
- ▶ Farbe: for 1001-179-6
- ▶ Content: 1000 ml
- ▶ Quantity per box: 12



- ▶ Item no. 2892-994-1
- ▶ Farbe: transparent
- ▶ Content: 1000 ml
- ▶ Quantity per box: 12



02

**Bitumen-based underbody protection**

**Bottom Guard Bitum**

- ▶ Item no. 2892-990-1
- ▶ Farbe: for 1001-179-6
- ▶ Content: Protector
- ▶ Quantity per box: 12



▶ **Technical specifications**

- Corrosion inhibitor to protect the chassis floor and wheel arches
- aromatic free
- fast drying
- good adhesion on various substrates
- good sound absorption properties
- permanently resistant to climatic influences





**01**  
**Cavity preservation**  
Protector

- ▶ Item no. 2892-998
- ▶ Farbe: transparent
- ▶ Content: 1000 ml
- ▶ Quantity per box: 12
  
- ▶ Technical specifications
- temperature resistant from -25 ° C to 160 ° C
- Interior preservation and sealing of bars, sills, cavities etc.
- good creeping effect

**02**  
**Cavity protection**  
Protector

- ▶ Item no. 2892-997
- ▶ Content: 400 ml
- ▶ Quantity per box: 15
  
- ▶ Technical specifications
- wax-based
- transparent
- Hard-to-reach cavities can be reached with the supplied hose
- temperature resistant from -30 ° C to 90 ° C
- enables optimal wetting of the areas to be protected
- does not contain silicone on the formulation side

Cavity Protection / Starter Set

**03**  
**Body protection**  
Long life

- ▶ Item no. 2892-997-1
- ▶ Content: 400 ml
- ▶ Quantity per box: 12
  
- ▶ Technical specifications
- displacing water
- creepable
- fast drying
- temperature resistant from -50 ° C to 90 ° C
- extremely abrasion resistant
- for sealing large body parts

**Replacement spray head**  
with capillary tube

- ▶ Item no. 2897-300-140
- ▶ PU: 2



**04**  
**"Body" starter set**  
6 pieces

- ▶ Item no. 2897-000-003
  
- 1x 1K Multi - Connector primer light 400ml (Item 2893-900)
- 1x Rednox - rust stop primer 400ml (Item 2893-888)
- 1x Protector - cavity protection 400ml (Item 2892-997)
- 1x Long Life - body protection 400 (Item 2892-997-1)
- 1x Rostinator - rust converter 400ml (Art. 2893-903)
- 1x Elox Plus - welding primer 400 ml (Item 2893-906)



01

**Pressure cup gun**  
for 1000 ml screw cans

► Item no. 2891-106-841

► Technical specifications

- for processing bottom guard and protector
- diverse structures can be injected
- Teflon seals
- suitable for metal



02

**Cavity spray hose set**  
for compressed air pressure cup gun

► Item no. 2891-106-842

► Technical specifications

- especially for the processing of Protector
- Hose Ø: 6 mm
- Hose length: 98 cm (with handle, including adapter), 116 cm (without handle, including adapter)

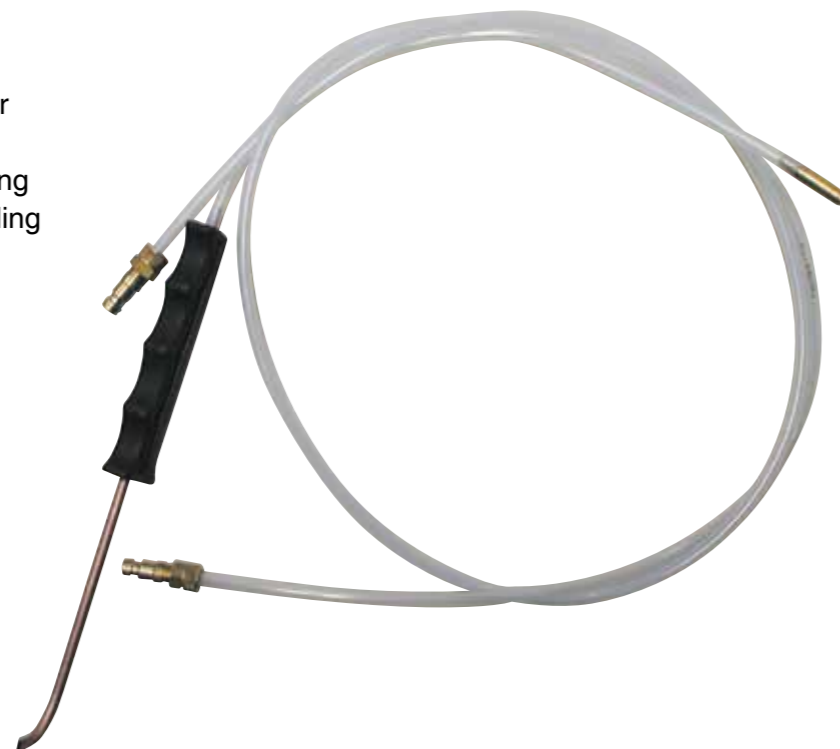

03

**Gun for underbody protection**  
including nozzles and riser pipe

► Item no. 2892-880

► Technical specifications

- fast



04

**Nozzle set for UBS pistol**  
for UBS pistol (Article No. 2892-880)

► Item no. 2892-880-1

► Technical specifications

- Nozzle set for UBS pistol (Article No. 2892-880)?
- Content:
- 3 x nozzles
- 3 x riser pipes





01

**UV-resistant and sprayable seam sealing**

Flexon Protect



- ▶ Item no. 2893-310
- ▶ Farbe: for sweeping wet and oily waste
- ▶ Width: 440 mm
- ▶ Wooden body with a socket for screw-threaded handles with hard PVC bristles
- ▶ Content: 310 ml

- ▶ Item no. 2893-311
- ▶ Farbe: for 1001-179-6
- ▶ Content: 310 ml
- ▶ Quantity per box: 12

- ▶ Quantity per box: 12

▶ **Technical specifications**

- UV-resistant
- elastic
- sandable
- silicone free
- wide range of adhesion on many metals (zinc, aluminum, steel), paints, primers, glass, wood, plastics (except PE, PP, PTFE) and mineral substrates
- Temperature resistance: -40 ° C to 80 ° C, briefly up to 120 ° C
- Skin formation after 20 minutes
- Can be painted over (recommendation: should be painted over within the first 2 hours, otherwise it could lead to adhesion problems, with some paint systems)



**Flat jet nozzle**

for Flexon Protect

- ▶ Item no. 2893-314
- ▶ PU: 10

- for double crochet seams
- Waveform

- To be used with Flexon Protect



02

**UV-resistant, paintable and sprayable sealant**

Flexon ST Protect



- ▶ Item no. 2893-312
- ▶ Farbe: beige
- ▶ Content: 310 ml
- ▶ Quantity per box: 12

▶ **Technical specifications**

- pasty consistency, so it can be sprayed and brushed on
- very good adhesion to various substrates (steel, zinc, aluminum, thermosets and thermoplastics except PE, PP, PTFE)
- Skin formation after 15 minutes
- Can be painted over (recommendation: should be painted over within the first 2 hours, otherwise it could lead to adhesion problems, with some paint systems)
- Temperature resistance: -40 ° C to 80 ° C briefly up to 120 ° C
- silicone free
- UV-resistant
- sandable
- Shore A hardness approx. 68
- Elongation at break approx. 150%
- Tensile strength approx. 2 N / mm<sup>2</sup>
- Tear resistance approx. 8 N / mm<sup>2</sup>



**Flat jet nozzle**

for Flexon Protect

- ▶ Item no. 2893-314
- ▶ PU: 10

- for double crochet seams
- Waveform

- To be used with Flexon Protect





01

**UV-resistant body adhesive and sealant**

Krypton Protect



- ▶ Item no. 2893-226-1
- ▶ Farbe: white
- ▶ Content: 310 ml
- ▶ Quantity per box: 12



- ▶ Item no. 2893-226-2
- ▶ Farbe: transparent
- ▶ Content: 310 ml
- ▶ Quantity per box: 12



- ▶ Item no. 2893-226-3
- ▶ Farbe: grey
- ▶ Content: 310 ml
- ▶ Quantity per box: 12



- ▶ Item no. 2893-226-4
- ▶ Farbe: black
- ▶ Content: 310 ml
- ▶ Quantity per box: 12



▶ **Technical specifications**

- Very good sealant with good adhesive properties
- 1K MS-based sealant and adhesive
- Excellent for sealing e.g. welded-in repair panels in the car body area
- Very good UV resistance
- Moisture and weather resistant
- Good adhesion to glass, many metals (zinc, aluminium, steel), paints, primers, wood materials, thermosetting and thermoplastic materials (except PE, PP, PTFE) and mineral substrates.
- When overpainting, paint the sealant after skin bonding, within the first 2-4 hours after application, as the sealant encapsulates on the surface after complete drying and paint adhesion can no longer be guaranteed.
- Temperature resistant: -40°C to +90°C
- Skin formation: 20 min.
- Drying time max 3-4mm/24h.



**Round nozzle**  
for plastic cartridges

- ▶ Item no. 2891-02-26
- ▶ PU: 12



02

**Body adhesive and sealant**

Proton Protect



- ▶ Item no. 2893-225-1
- ▶ Farbe: white
- ▶ Content: 300 ml
- ▶ Quantity per box: 12



- ▶ Item no. 2893-225-3
- ▶ Farbe: grey for sweeping wet and oily waste-  
Width: 440 mm Wooden body with a socket for  
screw-threaded handles with hard PVC bristles
- ▶ Content: 300 ml
- ▶ Quantity per box: 12

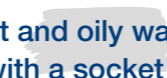

- ▶ Item no. 2893-225-2
- ▶ Farbe: for 1001-179-6
- ▶ Content: 300 ml
- ▶ Quantity per box: 12



▶ **Technical specifications**

- 1K polyurethane body adhesive with very good sealing properties
- good adhesion to primed and painted metals, aluminum, wood-based materials, customary mineral substrates and thermosets
- Can be painted over after hardening
- moisture and weather resistant
- temperature resistant from -40 ° C to 90 ° C (briefly up to 120 ° C)
- CE approval according to EN 15651 part 1
- contains anti-rust ingredients
- Proton can also be used on primed or painted surfaces if the surfaces have been degraded, cleaned and roughened
- 
- Proton is not UV resistant and must be painted over in the area where UV rays reach.
- It is important to note that the proton must be completely cured beforehand! (Curing speed depending on temperature and humidity max. 3-4mm in 24 hours.) Before overpainting, we recommend a paint compatibility test.

**Round nozzle**  
for aluminum cartridges with embossing

- ▶ Item no. 2891-02-25
- ▶ PU: 25





01

**Body glue**

Pluton

- ▶ Item no. 2893-223-4
- ▶ Farbe: grey
- ▶ Content: 280 ml
- ▶ Quantity per box: 12

## ▶ Technical specifications

- high strength after 30 min.
- Adheres to steel, aluminum, galvanized sheet metal, GRP and plastics without primer
- can be painted over
- permanently temperature resistant up to 80 ° C
- weldable
- Delivery without hand mixer and nozzles
- After application via the hand mixer, Pluton has a longer processing time of 2-4 hours and thus enables the alignment and positioning of larger components such as body parts, high roofs, etc.
- Complete hardening after 24 hours, depending on the adhesive strength.

**Replacement nozzles for sprayable seam seals**

for multi-compressed air gun (item no. 2891-03)

- ▶ Item no. 2891-03-1
- ▶ PU: 10
- for processing body sealants, window adhesives and sprayable seam seals

**Hand mixer, angular**

for Pluton

- ▶ Item no. 2893-223-38
- ▶ PU: 5
- Length: hand mixer 23 cm
- Diameter of the tip: approx. 0.5 cm
- Diameter? Connector: 2.2 cm

**Wing nozzle**

for laying and pulling wide, flat seams of sealant

- ▶ Item no. 2891-02-27
- ▶ PU: 6

**opener**

for cartridges

- ▶ Item no. 2891-02-50
- ▶ PU: 1



02

**Compressed air cartridge gun**

- ▶ Item no. 2891-05
- ▶ Technical specifications
- for processing sprayable seam seals
- incl. 10 long and 20 short nozzles

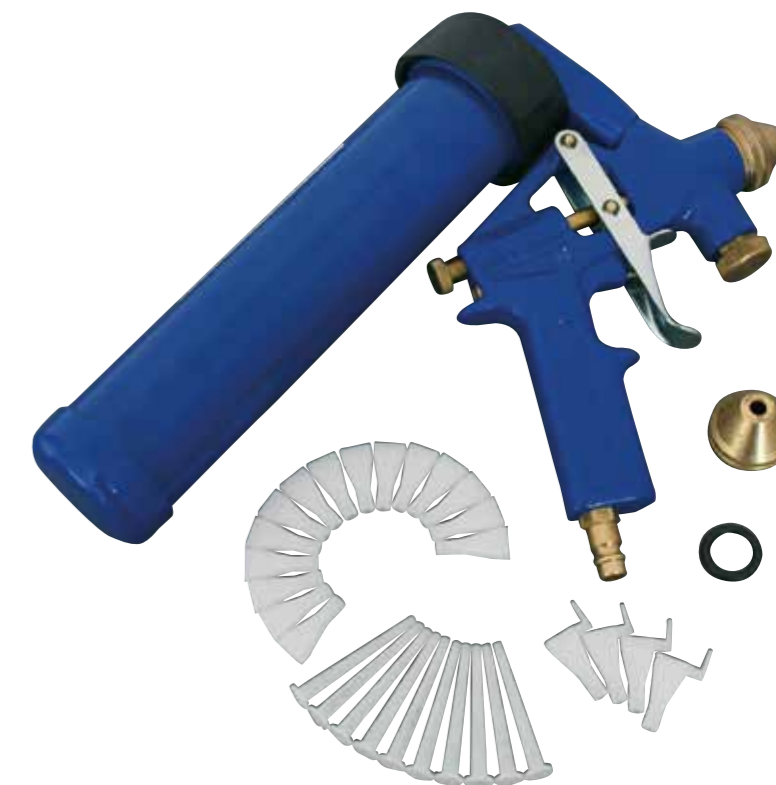

03

**Replacement spray tube**

for compressed air cartridge gun (Item No. 2891-05)

- ▶ Item no. 2891-051
- ▶ PU: 30



04

**brush**

for body sealants

- ▶ Item no. 4693-251-1
- ▶ Technical specifications
- Version: 1.0 "



01

**Plastic repair adhesive**

Repos

- ▶ Item no. 2700-10
- ▶ Content: 50 ml
- ▶ PU: 2
  
- ▶ Technical specifications
  - for gluing PVC, GRP, steel and aluminum
  - the material has a high elasticity
  - Drop time: 5 min.
  - can be sanded after approx. 90 min.



02

**Plastic repair adhesive**

Repos almost

- ▶ Item no. 2700-15
- ▶ Content: 50 ml
- ▶ PU: 2
  
- ▶ Item no. 2700-16
- ▶ Content: 25 ml
- ▶ incl. 4 mixing tubes
- ▶ PU: 1
  
- ▶ Technical specifications
  - for gluing PVC, GRP
  - the material has a high elasticity
  - Drop time: 90 sec.
  - can be sanded after approx. 15 min.

**mixer**

for plastic glue repos almost

- ▶ Item no. 2700-16-1
- ▶ PU: 10



03

**Structural adhesive**

Repos MMA

- ▶ Item no. 2700-20
- ▶ Content: 50 ml
- ▶ PU: 2
  
- ▶ Technical specifications
  - for gluing PVC, GRP, steel and aluminum
  - Material becomes rigid
  - temperature resistant: -50 ° C to 120 ° C
  - for connecting different substrates, such as: sun visor holder, plastic cladding, carbon on steel, aluminum parts on steel substrate and much more.
  - can be used without chemical or mechanical pretreatment
  - has an enormous tensile shear strength of 35 Mpa
  - without solvents and volatile organic compounds
  - Processing temperature: 10 ° C to 30 ° C
  - Dry to the touch after approx. 15 min.
  - completely dry after approx. 24 h
  - oil resistant





01

**Hand mixer, angular**

for plastic repair adhesives of the REPOS series

- ▶ Item no. 2700-42
- ▶ PU: 20

- ▶ Technical specifications
- suitable for Repos (2700-10), Repos Fast (2700-15) and REPOS MMA (2700-20)
- the new static mixer fabric achieves a very good mixing ratio



02

**Hand mixer short**

for plastic repair adhesives of the REPOS series

- ▶ Item no. 2700-41
- ▶ PU: 20

- ▶ Technical specifications
- suitable for Repos (2700-10) and Repos Fast (2700-15)
- 8cm long



03

**Hand mixer**

for plastic repair adhesives of the REPOS series

- ▶ Item no. 2700-40
- ▶ PU: 6

- ▶ Technical specifications
- suitable for plastic repair adhesive repos
- improved mixing ratio through new static mixer fabric
- Length: 15 cm



04

**Reinforcement tape**

Dimensions: 50mm x 4.0m

- ▶ Item no. 2700-60

- ▶ Technical specifications
- to stabilize the repair area
- 50 mm x 4.0 m



05

**Contour film for plastic repairs**

Dimensions: 125mm x 3.6m

- ▶ Item no. 2700-50

- ▶ Technical specifications
- for easy smoothing of the adhesive mass
- 125 x 3.6 mm



06

**Adhesive cleaner**

HR 150

- ▶ Item no. 2700-36
- ▶ Content: 150 ml

- ▶ Technical specifications
- cleans and is also an adhesion promoter (primer)
- it is ideally suited for the pretreatment of non-absorbent substrates made of metal and plastic



07

**Cartridge gun**

for plastic repair adhesives

- ▶ Item no. 2700-70

- ▶ Technical specifications
- quick operational readiness
- for 50 ml cartridges with two tubes
- made of plastic



08

**Metal light pressure pistol**

for plastic repair glue

- ▶ Item no. 2700-71

- ▶ Technical specifications
- easy squeezing
- stable plastic / metal housing
- quick operational readiness



01

**Starter set**

Repos

- ▶ Item no. 2700-001
- ▶ Content: 13 pieces

- Contents:

- 2 x Repos, synthetic glue, 50 ml (art. no. 2700-10)
- 2 x Repos fast, synthetic glue, 50 ml (art. no. 2700-15)
- 2 x Repos MMA, structural glue, 50 ml (art. no. 2700-20)
- 1 x Cartridge gun (art. no. 2700-70)
- 6 x Rod mixer square blue (art. no. 2700-42)



02

**Adhesive surface cleaner**

Glue-Ex

- ▶ Item no. 2893-200-10
- ▶ Content: 1000 ml
- ▶ Quantity per box: 12

▶ **Technical specifications**

- the ideal cleaner for cleaning surfaces to be covered
- can be used on all surfaces in the automotive sector, except for plastics
- colorless



03

**Power spray adhesive**

Super glue

- ▶ Item no. 2898-552
- ▶ Content: 400 ml
- ▶ Quantity per box: 12

▶ **Technical specifications**

- bonds foams, jute, felt, polystyrene foam, paper, cardboard, plastic films
- temperature resistant (permanent): -25 ° C to 70 ° C





01

**Wire mesh**

for plastic welding work

▶ Item no. 2701-30

▶ Technical specifications

- Package content: 10pcs.
- Size: 150mmx115mm

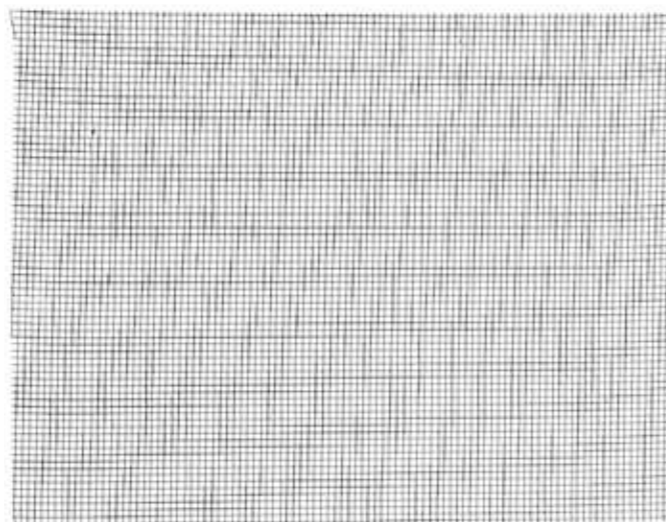

02

**welding wire**

for plastic welding work

▶ Item no. 2701-20



03

**Temperature protection**

for plastic welding work

▶ Item no. 2701-12



04

**Hot air gun**

2,300 W for hot air from 80-650 ° C

▶ Item no. 8697-000-992

▶ Technical specifications

- Power: 2,300W
- Temperature: 80 ° C-650 ° C
- Temperature display: display, in 10 ° C steps
- Air volume: 150-500 l / min
- Heating: ceramic heating
- Thermal protection shutdown: yes
- Protection class (without protective conductor connection): II
- Dimensions (LxWxH): 253 x 86.5 x 200 mm
- Mains connection: 230 V, 50/60 Hz
- Weight: 0.755 kg (without power cord)



05

**Reducing nozzle**

for plastic welding work

▶ Item no. 2701-11



06

**Repair nozzle**

For plastic repair adhesive

▶ Item no. 2701-10



01

**Cyanoacrylate superglue**

Rapido Protect

- ▶ Item no. 2898-555-200
- ▶ Content: 20 g
- ▶ Quantity per box: 25

## ▶ Technical specifications

- very high adhesive strength
- extremely good impact resistance
- ultra fast
- no blooming
- odorless
- remains flexible
- extremely firm
- suitable for porous materials
- Temperature resistance -40 ° C to 80 ° C



02

**Cyanoacrylate superglue**

Super fast

- ▶ Item no. 2898-560-20
- ▶ Content: 20 g
- ▶ colour: for 1001-179-6

## ▶ Technical specifications

- flexible
- especially suitable for bonding rubber linings, plastics and metals ?.
- Cyanoacrylate base
- ideal for bonding plastic, such as clips and clips
- black



03

**Superglue**

Rapido

- ▶ Item no. 2898-555-100
- ▶ Content: 20 g
- ▶ Quantity per box: 12

## ▶ Technical specifications

- for extreme loads
- suitable for a wide variety of materials that are exposed to strong vibrations
- Cyanoacrylate base



04

**Cyanoacrylate superglue**

Super fast

- ▶ Item no. 2898-555
- ▶ Content: 5 g
- ▶ Quantity per box: 12

## ▶ Item no. 2898-556

- ▶ Content: 20 g
- ▶ Quantity per box: 20

## ▶ Technical specifications

- for classic use
- based on cyanoacrylate
- precise application possibility
- high viscosity
- reinforces the smallest parts
- becomes rock hard
- sandable
- can be painted over
- extremely creeping
- can be used together with the mineral filler (item no. 2898-560-30) to fill gaps, cracks or holes in seconds and close or to even out unevenness
- to accelerate the hardening, please use our hardening accelerator FixitActiv (Art.-No. 2898-554-150)
- This low viscosity 1-component cyanoacrylate superglue sticks many materials like wood, leather, ceramic, plastic, rubber etc. within seconds. The temperature resistance is -30 ° C to 80 ° C.



05

**Mineral filler**

for cyanoacrylate superglue

- ▶ Item no. 2898-560-30
- ▶ Content: 30 g

## ▶ Technical specifications

- fine powder based on silicon dioxide
- is used together with Normfest cyanoacrylate adhesives to fill and close gaps, cracks or holes in seconds or to level out unevenness
- After curing, the filler can be mechanically treated and also painted over
- Density: > 1.5g / cm<sup>3</sup> 20 ° C





01

**Glue starter set**

7 pieces

▶ Item no. 1957-600

▶ Contents:

- 1 x Fixit Superglue Gel 20g (Art. 2898-554)
- 1 x Fixit Active hardening accelerator 200ml (art. 2898-554-150)
- 1 x Rapido 20g (Art. 2898-555-100)
- 1 x Super fast superglue 20g (Art. 2898-556)
- 1 x Mineral filler 30g (Art. 2898-560-30)
- 1 x Superglue black medium viscosity 20g (Art. 2898-560-20)
- The glue starter pack in a practical plastic case. The right glue for every strong connection.



02

**Hardening accelerator**

Fixit Activ

▶ Item no. 2898-554-150

▶ Content: 200 ml

▶ Quantity per box: 12

▶ Technical specifications

- Suitable as a hardening accelerator for all cyanoacrylate adhesives
- for leather, wood, cork, ceramic and all porous materials and plastic compounds



03

**Superglue gel**

Fixit

▶ Item no. 2898-554

▶ Content: 20 g

▶ Quantity per box: 30

▶ Technical specifications

- does not run, pasty
- can also be used in horizontal and vertical positions
- does not pull strings
- Bonding of metals, wood and plastics
- Cyanoacrylate base



04

**Two-component cyanoacrylate adhesive**

2K CA

▶ Item no. 2700-25-10

▶ Content: 10 g

▶ Technical specifications

- excellent adhesive properties of many materials
- Gap filling capacity 6mm
- Overhead and vertical applications
- resistant to petrol and diesel
- with little bloom
- Thixotropic
- drip-free
- extremely impact resistant
- mechanically workable
- transparent bonding of PMMA
- Delivery with 3 mixing tips



05

**Two-component cyanoacrylate adhesive - flexible**

2K CA Flex

▶ Item no. 2700-25-20

▶ Content: 10 g

▶ Technical specifications

- excellent adhesive properties on many materials
- remains flexible
- mechanically workable
- Gap filling capacity 6mm
- Overhead and vertical applications
- transparent bonding of PMMA
- resistant to petrol and diesel
- with little bloom
- thixotropic
- drip-free



06

**Mixing tips**

for 2K CA two-component cyanoacrylate adhesive

▶ Item no. 2700-25-1

▶ Content: 10 piece



01

**Bodytec I**

Dent repair kit

► Item no. 8714-999-999



## ► Technical specifications

- for professional dent repair from the outside
- no dismantling of panels necessary
- easy to do
- recyclable hard plastic mushroom
- Find the right hard plastic mushroom quickly and easily
- 
- Contents of the case: 13 parts
- 1 x microfibre cloth blue 40x40 cm (Item No. 2000-640-40)
- 1 x Glue-Ex adhesive surface cleaner 1000 ml (Item No. 2893-200-10)
- 1 x Terpanol Power High-Tech special cleaner 400 ml (Item No. 2897-323)
- 1 x Arctic ice spray 200 ml (Item No. 2897-325)
- 1 x Bodytec repair bridge (item no. 8714-600)
- 1 x hot glue gun 230V / 200W (Item No. 8714-607-1)
- 2 x set of glue sticks, black PU: 5 (Item No. 8714-611-7)
- 1 x nylon striker dia. 13 mm (Item No. 8714-612-6)
- 1 x set of repair mushrooms 16 mm PU: 2 (Item No. 8714-614-2)
- 1 x set of repair mushrooms 21 mm PU: 2 (Item No. 8714-614-3)
- 1 x set of repair mushrooms 27 mm PU: 2 (item no. 8714-614-4)
- 1 x set of repair mushrooms 32 mm PU: 2 (Item No. 8714-614-5)

02

**Bodytec II**

Dent repair kit

► Item no. 8714-999-998



## ► Technical specifications

- quick dent repair
- Repair of larger dents
- Removal of various dent shapes
- 
- Contents: 27 parts
- 1 x microfibre cloth blue 40x40 cm (Item No. 2000-640-40)
- 1 x Glue-Ex 1000 ml (Item No. 2893-200-10)
- 1 x Terpanol Power 400 ml (Item No. 2897-323)
- 1 x Arctic 200 ml (Item No. 2897-325)
- 1 x Bodytec hammer (Item No. 8714-601)
- 1 x hot glue gun 230V / 200W (Item No. 8714-606)
- 10 x blue glue sticks (Item No. 8714-611-9)
- 1 x nylon striker pin Ø 13 mm (item no.8714-612-6)
- 1 x orange mushroom Ø 40 mm flexible (Item No. 8714-614-10)
- 1 x orange mushroom Ø 35 mm flexible (item no.8714-614-9)
- 1 x mushroom orange oval 50x30 mm flexible (Item No. 8714-614-11)
- 1 x mushroom blue Ø 40 mm (Item No. 8714-614-7)
- 1 x blue mushroom Ø 35 mm (Item No. 8714-614-6)
- 1 x blue mushroom Ø 32 mm (Item No. 8714-614-5)
- 1 x mushroom blue Ø 27 mm (Item No. 8714-614-4)
- 1 x mushroom blue Ø 21 mm (Item No. 8714-614-3)
- 1 x mushroom blue Ø 16 mm (Item No. 8714-614-2)
- 1 x mushroom blue oval 50x30 mm (Item No. 8714-614-8)





01

**Work lamp for dent repair**

Including suction cup

► Item no. 8714-610

► Technical specifications

- flexible usage
- Can also be used as a hand lamp thanks to the removable flexible arm
- Paint-friendly suction cup with a diameter of 120 mm
- 300 mm long flex arm with cross handle
- Easy on the eyes thanks to the prismatic protective glass?
- 220/240 volts with automatic switch-off
- 50/60 Hz
- 900 lumens
- 210 mm light length
- Width: 38.5 mm
- Length: 65mm
- 11 watt fluorescent lamp
- 5m lead



02

**Repair bridge**

for Bodytec

► Item no. 8714-600

► Technical specifications

- flexible feet
- Material: metal



03

**Repair mushrooms**

► Technical specifications

- These repair mushrooms are made of plastic and are used to repair dents with the help of our Bodytec system. Each packaging unit contains two pieces of the same diameter.



Item No.	Ø mm	colour	shape	PU
8714-614-2	16	blue	rigid	2
8714-614-3	21	blue	rigid	2
8714-614-4	27	blue	rigid	2
8714-614-5	32	blue	rigid	2
8714-614-6	35	blue	rigid	2
8714-614-7	40	blue	rigid	2
8714-614-8	50 x 30	blue	rigid	2
8714-614-9	35	orange		2
8714-614-10	40	orange		2
8714-614-11	50 x 30	orange		2

01

**Glue sticks**  
transparent

- ▶ Item no. 8714-611-8
- ▶ PU: 6
- ▶ Technical specifications
- Colour: transparent
- Length: 20 cm
- for hot glue gun 8714-607-1



02

**Glue sticks**  
Color: black, content: 5 pieces,  
with strong adhesive power

- ▶ Item no. 8714-611-7
- ▶ PU: 5
- ▶ Technical specifications
- Length: 20 cm
- for hot glue gun 8714-607-1



03

**HD glue sticks**  
Color: blue, content: 5 pieces

- ▶ Item no. 8714-611-9
- ▶ PU: 6
- ▶ Technical specifications
- Length: 20 cm
- for hot glue gun 8714-607-1

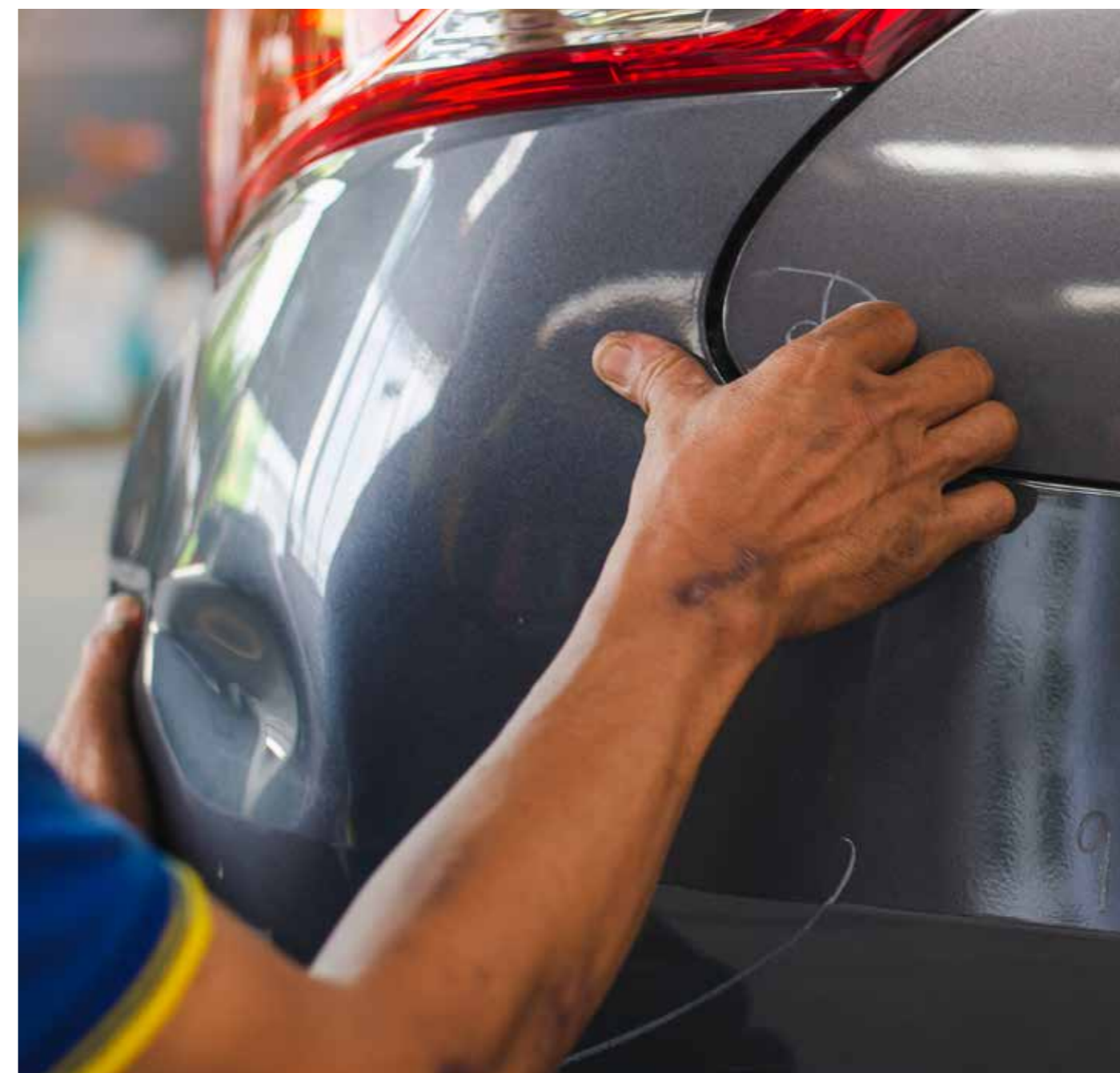

04

**Percussion hammer**  
for Bodytec system

- ▶ Item no. 8714-601



05

**Nylon striker**  
Ø 13 mm

- ▶ Item no. 8714-612-6



06

**Hot glue gun**  
electronically regulated

- ▶ Item no. 8714-607-1
- ▶ Technical specifications
- Bonding point is firm and resilient after approx. 2 minutes.
- high melting capacity
- Changeable nozzle
- electronic temperature control through modern PTC heating technology
- easy handling thanks to the mechanical feed device for glue sticks





01

**Cut-off wheels**

Twister

► Technical specifications

- Cutting width 0.8 mm
- suitable for ultra-high-strength thin sheet metal of the latest generation of vehicles
- high flexibility
- clean cut surfaces, little burr formation
- suitable for plastic, thin VA sheets and steel
- short separation times
- little cutting waste and dust development
- reduced machine load
- high break resistance
- low temperature load
- max. 13,300 rpm
- Bore 22.2
- use with spacer



Item No.	Ø mm	Thickness mm		PU
4667-115-8	115	0,8	22,2	1 / 30
4667-125-8	125	0,8	22,2	1 / 30

02

**Cutting discs**

Snake Performance

► Technical specifications

- 20% longer service life than conventional cutting discs
- Cutting width 1.0 mm
- clean cut surfaces, low burr formation
- little cutting waste and dust development
- low temperature load
- suitable for plastic, VA sheets and steel
- short separation times
- high break resistance
- reduced machine load
- max.rpm. 24,300



Item No.	Ø mm	Thickness mm		PU
4667-063-1	63	1,0	6,0	1 / 30
4667-115-1	115	1,0	22,2	1 / 30
4667-125-1	125	1,0	22,2	1 / 30
4667-100-100	100	1,0	10,0	25

03

**Cutting discs**

Inox

► Technical specifications

- strong composite resin
- good stability



Item No.	Ø mm	Thickness mm		PU
4667-060-20	60	2,0	6,0	25
4667-115-12	115	1,2	22,2	1 / 30
4667-115-25	115	2,5	22,2	25
4667-125-12	125	1,2	22,2	1 / 30
4667-125-25	125	2,5	22,2	25
4667-180-25	180	1,6	22,2	25
4667-230-25	230	1,9	22,2	25

04

**Grinding disks**

Inox

► Technical specifications

- for steel / stainless steel
- for maintenance and repair work
- for bodywork and paint finishing



Item No.	Ø mm	Thickness mm		PU
4669-063-60	63	6,0	6,0	1
4669-115-60	115	6,0	22,20	1
4669-125-60	125	6,0	22,20	1

01

**Roughing and flap disc**

Vanish

► **Technical specifications**

- A clear view of the area to be processed enables precise work and constant control
- combines the removal rate of grinding discs with the speed of a flap disc
- 25% less temperature development compared to conventional grinding discs
- excellent for working on weld seams or removing rust, paint, etc.
- max. 13,300 rpm

Item No.	Ø mm	Grit
4670-115-36	115	36



02

**Abrasive mop discs**

beveled shape

Item No.	Ø mm	Grit	PU
4662-115-036	115	36	1 / 10
4662-115-040	115	40	1 / 10
4662-115-060	115	60	1 / 10
4662-115-080	115	80	1 / 10
4662-125-036	125	36	1 / 10
4662-125-040	125	40	1 / 10
4662-125-060	125	60	1 / 10
4662-125-080	125	80	1 / 10



03

**Flap discs**

Abrasive mop discs

► **Technical specifications**

- 100% pure zirconium corundum
- 72 abrasive flaps
- very robust Y-polyester carrier
- very fast and aggressive cutting performance
- very long service life
- beveled shape

Item No.	Ø mm	Grit	PU
4663-115-040	115	40	1 / 10
4663-115-060	115	60	1 / 10
4663-115-080	115	80	1 / 10
4663-125-040	125	40	1 / 10
4663-125-060	125	60	1 / 10
4663-125-080	125	80	1 / 10



04

**Vulcanized fiber discs**

Item No.	Ø mm	Grit	PU
4665-115-24	115	24	1 / 25
4665-115-36	115	36	1 / 25
4665-115-40	115	40	1 / 25
4665-115-60	115	60	1 / 25
4665-115-80	115	80	1 / 25
4665-178-24	178	24	1 / 25
4665-178-36	178	36	1 / 25
4665-178-40	178	40	1 / 25

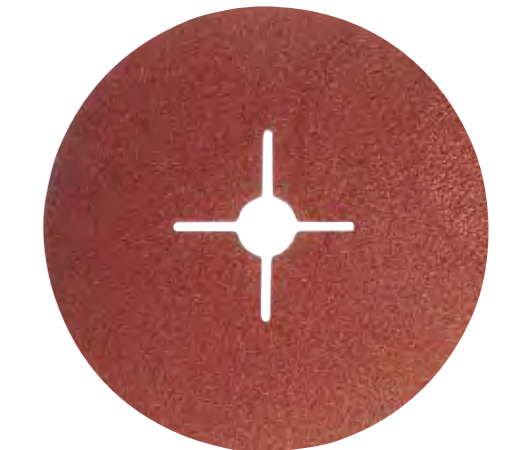

05

**Rubber disc**

for Vulkan fiber discs

Item No.	Ø mm
4666-115	115
4666-178-14	178





Elektrowerkzeug von NORMFEST.  
Qualität, die überzeugt.

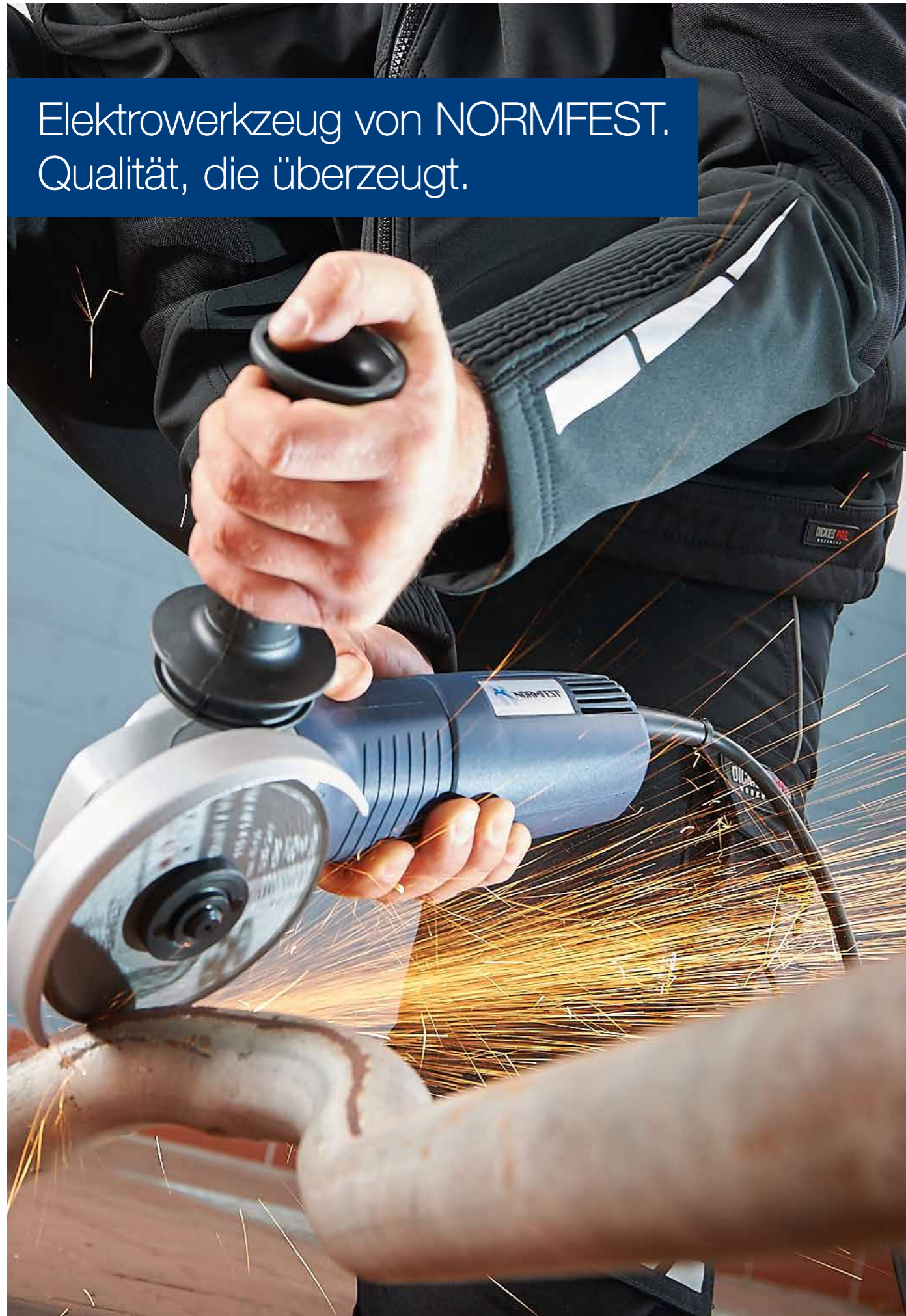

01

### Angle grinder 2000 watt Ø230 mm standard

► Item no. 7983-006-1

► Technical specifications

- Power: 2,000 watts
- Speed: 6,600 rpm
- for disc Ø: 230 mm
- Spindle: M 14
- Weight: 5.6 kg
- Packing: carton
- Scope of delivery: machine WITHOUT accessories
- 
- Soft start

- Endurance lock
- Restart protection
- Anti-twist protective cover
- Dust protection
- Additional anti-vibration handle
- Magnesium gear housing
- Switch-off carbon brushes



02

### Protective cover for angle grinder Ø230mm

► Item no. 7983-000-302

► Technical specifications

- for angle grinder item no. 7983-006-1





01  
**Nylon cloth grinding wheels**

Item No.	Ø mm	PU
4585-1-115	115	1 / 5

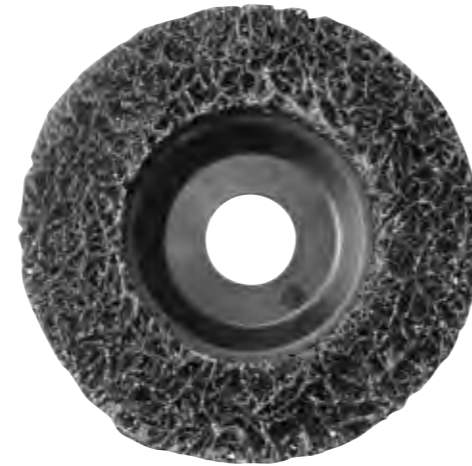

02  
**Nylon cloth grinding wheels**

- Technical specifications
- black grinding wheel, which consists of a nylon fabric
- A grain resin is also applied to this fabric

Item No.	Ø mm	max.rpm	PU
4585-1-100	100	8.000	1
4585-1-150	150	5.500	1



03  
**Nylon fabric grinding wheel**  
red, hard, cool finish

- Technical specifications
- very fast and aggressive cleaning performance
- extremely long service life thanks to ceramic-corundum grain
- no geometric change in the surfaces
- no corrosive residues on the workpiece surface

Item No.	Ø mm	admission	PU
4585-2-100	100	for drill	1
4585-2-115	115	for angle grinder	1
4585-2-150	150	for drill	1



04  
**Tensioning spindle**  
for nylon fabric grinding wheels



Item No.	Ø mm	Suitable for	PU
4585-110-01	6		1
4585-115-01	8		1



01

**Abrasive discs**

Zircoloc

► **Technical specifications**

- minimal temperature development due to additives in the binder
- the fabric back ensures a high degree of flexibility
- ideal for:
  - Grinding back weld seams / points
  - Removal of rust spots
  - Removing old paints and primers

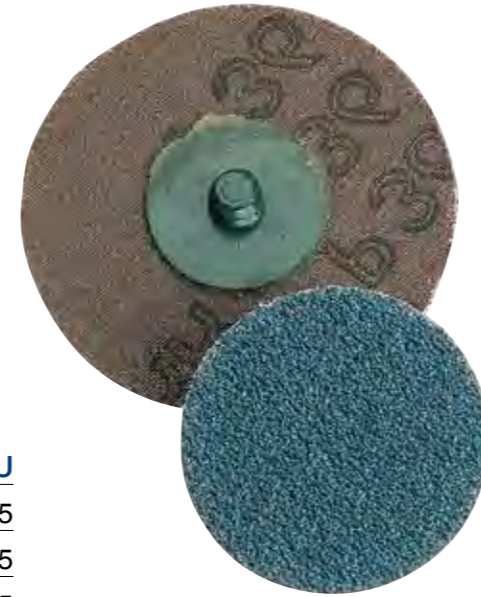

Item No.	Ø mm	Grit	max.rpm	PU
4679-02-24	50	24	30.000	25
4679-02-36	50	36	30.000	25
4679-02-60	50	60	30.000	25
4679-02-80	50	80	30.000	25
4679-02-120	50	120	30.000	25
4679-03-24	75	24	20.000	25
4679-03-36	75	36	20.000	25
4679-03-60	75	60	20.000	25
4679-03-80	75	80	20.000	25
4679-03-120	75	120	20.000	25

02

**Mini flap discs**

Flexloc

► **Technical specifications**

- high removal rate
- good service life
- very flexible due to inclined compartments
- well suited for hard-to-reach places?
- ideal for:
  - Grinding back weld seams / points
  - Removal of rust spots
  - Removing old paints and primers
  - Deburring sheet metal



Item No.	Ø mm	Grit	max.rpm	PU
4679-50-36	50	36	30.000	5
4679-50-60	50	60	30.000	5
4679-50-80	50	80	30.000	5
4679-75-36	75	36	20.000	5
4679-75-60	75	60	20.000	5



03

**Abralon**

High performance zircoloc

► **Technical specifications**

- high removal rate
- quick cut
- extremely long service life
- low heat generation
- little wear
- max. 30,000 rpm.
- Grit 36
- Disc Ø 50mm
- Color green

- ideally suited:

- Grinding back weld seams / points
- Removal of rust spots
- Sanding off paints and primers
- Removing damage to aluminum rims

Item No.	Ø mm	Grit	max.rpm	PU
4679-04-24	50	24	30.000	25
4679-04-36	50	36	30.000	25
4679-04-60	50	60	30.000	25
4679-04-80	50	80	30.000	25
4679-04-120	50	120	30.000	25
4679-05-24	75	24	20.000	25
4679-05-36	75	36	20.000	25
4679-05-60	75	60	20.000	25
4679-05-80	75	80	20.000	25
4679-05-120	75	120	20.000	25





01

**Fabric grinding wheel**

Sandloc

► **Technical specifications**

- extremely flexible fabric grinding wheels with very little heat generation
- ideally suited for sanding in beads and curves
- Removal of sealing compounds and residues of solid seals
- Sanding of fillers
- Removing old paints and primers

Item No.	Ø mm	execution	max.rpm	PU
4679-22-50	50	Fine (blue)	30.000	25
4679-22-75	75	Fine (blue)	20.000	25
4679-23-50	50	Medium (red)	30.000	25
4679-23-75	75	Medium (red)	20.000	25
4679-25-115	115	Coarse (yellow)	10.000	10
4679-25-50	50	Coarse (yellow)	30.000	25
4679-25-75	75	Coarse (yellow)	20.000	25



02

**Nylon fabric grinding wheel**

VORTEX Rapid blend

► **Technical specifications**

- up to 18,000 rpm
- patented high-performance abrasive grain
- open structure
- high stock removal rate (coarse / medium / fine)
- Sanding with three sides possible
- enormous service life (5-8 longer than competitive products)
- particularly stable, no deformation of the disc
- for the Normloc recording system
- applicable to various materials, steel, aluminum

Item No.	Ø mm	max.rpm	PU
4585-4-75	75	18.000	5



03

**Nylon fabric sanding disc BLAZE**

BLAZE

► **Technical specifications**

- ceramic high-performance corundum
- open structure
- high removal rate (coarse)
- enormous service life
- particularly flexible
- for the Normloc recording system
- applicable to various materials

Item No.	Ø mm	max.rpm	PU
4585-3-50	50	15.500	10
4585-3-75	75	12.000	10
4585-3-150	150	12.000	1



04

**Fabric grinding wheels**

Blackloc

► **Technical specifications**

- For removing loose rust, old paint, body sealants and underbody protection
- extremely open structure
- long service life
- low heat development
- for the Normloc recording system
- applicable to various materials

Item No.	Ø mm	max.rpm	PU
4679-47	50	30.000	10
4679-48	75	20.000	10





01

**Normloc recording system**

including shaft 6 mm

► The Normloc mounting system consists of a hard polyurethane backing pad that can be processed with a drill or with the mini one-hand angle grinder. With the M14 adapter, the backing pad can also be mounted on an angle grinder.



Item No.	Ø mm	max.rpm	PU
4679-90-94	30	40.000	1
4679-90-92	50	30.000	1
4679-90-93	75	20.000	1

02

**3M recording system**

Ø 75mm, for Bristle Disc

► Item no. 4679-90-931



03

**Mounting shaft Normloc**

Ø 6mm

► Item no. 4679-99-6



04

**adapter**

for angle grinder (8696-1-80)

► Item no. 4679-99-8

► Technical specifications  
 - M14 internal thread  
 - For mounting the Normloc mounting system on an angle grinder



04

**Bristle Disc**

3M

► Technical specifications  
 - to expose welding points  
 - for removing sealing compounds, underbody protection and residues of solid seals



Item No.	Ø mm	execution	max.rpm	PU
4679-44	50	fine - white	25.000	1
4679-45	50	medium - yellow	25.000	1
4679-46	50	coarse - green	25.000	1
4679-46-75	75	coarse - green	15.000	1

01

**Sandpaper gold with Velcro**

ø 150 mm - gold, Mirka, 7 holes, Hutchinson

► **Technical specifications**

- 6 perforated once
- flexible and aggressive
- high quality universal product
- Grain type: aluminum oxide
- Binder: synthetic resin, progressive bond
- Backing material: flexible latex paper
- Scatter: half-open
- Color gold



Item No.	Ø mm	Grit	PU
4657-080	150	80	100
4657-010-0	150	100	100
4657-012-0	150	120	100
4657-018-0	150	180	100

02

**Slide paper**

yellow

► **Technical specifications**

- Strip 115mm x 280mm
- unperforated
- without adhesion
- flexible sandpaper openly scattered
- for pre- and intermediate sanding in the painting area with vibration sander or by hand
- Grit type: aluminium oxide
- Binder: Synthetic resin, Progressive resin
- Base material: Flexible latex paper
- Scattering: semi-open



Item No.	Grit	PU
4676-40	40	50
4676-60	60	50
4676-80	80	100
4676-100	100	100
4676-120	120	100
4676-150	150	100
4676-180	180	100
4676-240	240	100



03

**Sanding mouse, hand sanding block**

Grinding mouse

► **Item no. 4662-100**► **Technical specifications**

- for 150 mm Velcro discs
- lightweight
- made of plastic





01

**Emery cloth roll**

Item No.	Grit	Width (mm)	Length [m]
4674-40-40	40	40	25
4674-40-60	60	40	25
4674-40-80	80	40	25
4674-40-100	100	40	25
4674-40-120	120	40	25
4674-40-240	240	40	25
4674-40-400	400	40	25
4674-50-40	40	50	25
4674-50-60	60	50	25
4674-50-80	80	50	50
4674-50-100	100	50	50
4674-50-120	120	50	50
4674-50-180	180	50	50
4674-50-240	240	50	50
4674-50-400	400	50	50

02

**Embroidery strips unperforated**

70 x 450 mm

► **Technical specifications**

- Grain type: Aluminium oxide
- Binder: Synthetic resin
- Support material: Flexible latex paper
- Scattering: Semi-open
- Colour: Gold
- Flexible and aggressive

Item No.	Grit	PU
4678-40	40	50
4678-80	80	50
4678-120	120	100

03

**waterproof wet sandpaper**

Sheet 230 mm x 280 mm

► **Technical specifications**

- for fine sanding work before polishing
- for all wet sanding work
- Sheet 230mm x 280mm
- waterproof

Item No.	Grit	PU
4673-80	80	50
4673-120	120	50
4673-180	180	50
4673-240	240	50
4673-320	320	50
4673-360	360	50
4673-400	400	50
4673-600	600	50
4673-800	800	50
4673-100-0	1000	50
4673-120-0	1200	50
4673-150-0	1500	50
4673-200-0	2000	50



04

**File block**

for file strips

► **Item no. 4652-70-400**► **Technical specifications**

- the ergonomic shape ensures easy and fatigue-free handling
- The molded plastic body ensures a high level of resistance and durability
- with valve to regulate the suction force and optimize the air / dust extraction



01

**Grinding roller**

## ► Technical specifications

- Zirconia, fabric with full synthetic resin bond
- very high removal rate
- Top binder with active abrasive ingredients
- Areas of application:
  - Stainless steel, non-ferrous metals, structural and material steels - as well as difficult-to-machine metallic materials
  - Grinding of cast skins, processing of weld seams, general deburring
  - Finishing of shaped surfaces
- Zirconia, fabric with full synthetic resin bond



Item No.	Ø mm	Width (mm)	Grit	min. rpm	max.rpm	PU
4675-15-50	15	30	50	2.500	36.000	10
4675-15-150	15	30	150	2.500	36.000	10
4675-22-50	22	20	50	18.000	26.000	10
4675-22-150	22	20	150	18.000	26.000	10
4675-30-50	30	30	50	13.000	19.000	10
4675-30-150	30	30	150	13.000	19.000	10
4675-45-50	45	30	50	9.000	13.000	10

02

**Holder for grinding roller**

## ► Technical specifications

- Rubber body with 6 mm steel shaft
- The centrifugal tension ensures a non-slip fit of the grinding roller
- for the use of grinding rollers



Item No.	Shaft Ø [mm]	PU
4675-15	15	1
4675-22	22	1
4675-30	30	1
4675-45	45	1
4675-60	60	1

03

**Fan roller**

## ► Technical specifications

- Fine grinding and polishing work
- on stainless steel, steel and non-ferrous metals
- especially for surface smoothing
- and suitable for fine polishing
- even, seamless sanding pattern



Item No.	Ø mm	Width (mm)	Shaft Ø [mm]	Grit	max.rpm	PU
4675-30-60	30	10	6	60	18.000	5
4675-30-80	30	10	6	80	18.000	5
4675-30-120	30	10	6	120	18.000	5
4675-40-60	40	20	6	60	18.000	5
4675-40-80	40	20	6	80	18.000	5
4675-60-60	60	30	6	60	12.000	5
4675-60-80	60	30	6	80	12.000	5
4675-60-120	60	20	6	120	12.000	5
4675-80-60	80	50	6	60	7.500	5
4675-80-80	80	50	6	80	7.500	5



01

**Round brush**

- ▶ Technical specifications
- Steel wire hardened
- corrugated
- total-Ø 50 mm
- with 6 mm shank



Item No.	execution	Width (mm)	Wire Ø	max.rpm	PU
4691-926-049	Opel	10	0,3	15.000	1
4691-926-050	coarse	10	0,5	15.000	1
4691-926-051	fine	7	0,3	15.000	1

02

**Round shank brush**

Hardened steel wire, knotted, smooth

- ▶ Technical specifications
- Hardened steel wire
- plaited
- smooth



Item No.	Ø mm	max.rpm	PU
4691-925-905	70	20.000	1

03

**Braid brush**

M14



Item No.	Ø mm	max.rpm	PU
4691-925-941	65	12.500	1

04

**Universal braid brush**

- ▶ Technical specifications
- Wire thickness: 0.5 mm
- Axle hole diameter: 22.2 mm



Item No.	Ø mm	max.rpm	PU
4691-925-911	115	12.000	1
4691-925-912	125	12.000	1

05

**Centrifugal brush**

Steel wire, braided

- ▶ Technical specifications
- for drill
- Steel wire
- plaited



Item No.	Ø mm	max.rpm	PU
4691-925-900	19	20.000	1
4691-925-901	28	20.000	1

06

**Long-term brush**

- ▶ Item no. 4691-925-910 | Long-term brush Thickness 7 mm
- ▶ Item no. 4691-925-920 | Mounting shank Ø 13 mm





For working on aluminium bodywork.

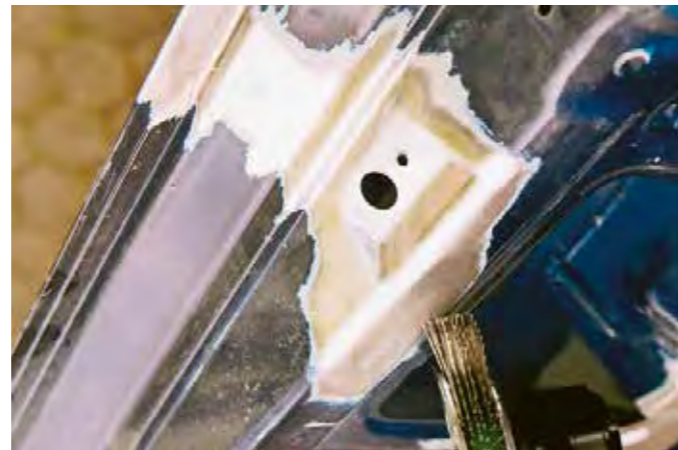

For removing paint from contours.



For removing films from metal surfaces and paint without damage.

01

**Pneumatic machine MBX**

ideal for foil erasers

▶ Item no. 4692-123

▶ Technical specifications

- Weight: 1.1 kg
- Thread air pressure connection: Rp 1/4 "
- Speed: 0-3500 min-1
- Required flow pressure: 6.2 bar / 90 psi
- average air consumption: 17.5 CFM (500 l / min)



02

**MBX starter set**

for the professional processing of steel

▶ Item no. 4692-900

▶ Technical specifications

- Weight: 1.1 kg
- Thread air pressure connection: Rp 1/4 "
- Required hose diameter: 3/8 "ID (9.5 mm)
- Speed: 0-3500 min-1
- Required flow pressure: 6.2 bar / 90 psi
- required Inner tube diameter: 9.5 mm
- Average air consumption: 17.5 CFM (500 l / min.)
- Sound pressure level: 83 dB (DIN 45635-21; ISO 3744)?
- Content:
  - 1 x 4692-123 MBX pneumatic machine
  - 1 x 4692-211 MBX mounting system 1 mm
  - 1 x 4692-223 MBX mounting system 23 mm
  - 1 x 4692-523 MBX brush belt, coarse 23 mm
  - 1 x 4692-411 MBX brush belt, medium 11 mm
  - 1 x 4692 311 MBX fine brush belt 11 mm
  - 1 x 4692-800 MBX foil eraser





01

**Brush belt MBX**

- Technical specifications
- z. B. for cleaning steel seals

Item No.	execution	width	PU
4692-311	fine	11 mm	5
4692-323	fine	23 mm	5
4692-411	medium	11 mm	5
4692-423	medium	23 mm	5
4692-511	coarse with elbow	11 mm	10
4692-523	coarse with elbow	23 mm	5



02

**Brush belt stainless steel MBX**

- Technical specifications
- for machining aluminum bodies

Item No.	execution	width	PU
4692-611	with elbow	11 mm	5
4692-623	with elbow	23 mm	5
4692-723	without elbow	23 mm	5



03

**Foil eraser MBX**

- Technical specifications
- for removing adhesive residues on metal surfaces and paints
- comfortable handling
- high working speed
- no paint damage
- long life span

Item No.	Width (mm)	Ø mm	PU
4692-800	23	100	1



04

**Recording system MBX**

- Technical specifications
- the holder is for all brush belts and foil erasers with a width of 11 mm that are processed with the MBX processing machine
- the machine adapter is suitable for our patented MBX compressed air device (item no. 4692-123)

Item No.	Width (mm)	PU
4692-211	11	1
4692-223	23	1



05

**Bodyline cutting / grinding wheel kit**

Rod grinder with accessories

- Item no. 4667-001
- 10x "Inox" grinding discs, 63 x 6.0
- 30x "Snake Performance" cutting discs, 63 x 1.0 x 6.0
- 1x clamping bolt, mounting 6 mm
- 1x die grinder "Low Noise"
- 1x NF safety glasses "X-ONE"



01

**Night Line HSS twist drill**  
profile ground, DIN 338

- ▶ Technical specifications
- Profile ground
- ground from a solid blank
- HSS drill
- Suitable for hand drills
- Point angle 118 °
- relatively good penetration behavior
- reduced cross cutting edge
- high stability
- quiet running behavior



Item No.	Ø mm	PU
4626-10	1,0	10
4626-15	1,5	10
4626-20	2,0	10
4626-25	2,5	10
4626-30	3,0	10
4626-35	3,5	10
4626-40	4,0	10
4626-42	4,2	10
4626-45	4,5	10
4626-48	4,8	10
4626-50	5,0	10
4626-52	5,2	10
4626-55	5,5	10
4626-60	6,0	10
4626-62	6,2	10
4626-65	6,5	10

Item No.	Ø mm	PU
4626-68	6,8	10
4626-70	7,0	10
4626-75	7,5	10
4626-80	8,0	5
4626-85	8,5	5
4626-90	9,0	5
4626-95	9,5	5
4626-100	10,0	5
4626-105	10,5	5
4626-110	11,0	1
4626-115	11,5	1
4626-120	12,0	1
4626-125	12,5	1
4626-130	13,0	1
4626-135	13,5	1
4626-140	14,0	1

02

**Night Line HSS twist drill box 1.0-10.0mm**  
profile ground, DIN 338

- ▶ Item no. 4626-001-10 | Diameter 1.0-10.0 mm (0.5 mm increments)
- ▶ Item no. 4626-001-13 | Diameter 1.0-13.0 mm (0.5 mm increments)
- ▶ Technical specifications
- Features:
- Profile ground
- ground from a solid blank
- HSS drill
- Suitable for hand drills
- Point angle 118 °
- relatively good penetration behavior
- reduced cross cutting edge
- high stability
- quiet running behavior



03

**Night line set**  
Drill assortment

- ▶ Item no. 1900-97
- ▶ Contents: 13-piece kit

- Content:
- 1 pc. 4626-20 NIGHT LINE TWIST DRILL 2.0MM
- 1 pc. 4626-25 NIGHT LINE TWIST DRILL 2.5MM
- 1 pc. 4626-30 NIGHT LINE TWIST DRILL 3.0MM
- 1 pc. 4626-35 NIGHT LINE TWIST DRILL 3.5MM
- 1 pc. 4626-40 NIGHT LINE TWIST DRILL 4.0MM
- 1 pc. 4626-45 NIGHT LINE TWIST DRILL 4.5MM
- 1 pc. 4626-50 NIGHT LINE TWIST DRILL 5,0MM
- 1 pc. 4626-55 NIGHT LINE TWIST DRILL 5.5MM
- 1 pc. 4626-60 NIGHT LINE TWIST DRILL 6,0MM
- 1 pc. 4626-65 NIGHT LINE TWIST DRILL 6.5MM
- 1 pc. 4626-70 NIGHT LINE TWIST DRILL 7,0MM
- 1 pc. 4626-75 NIGHT LINE TWIST DRILL 7.5MM
- 1 pc. 4626-80 NIGHT LINE TWIST DRILL 8.0MM





01

**Stratus - HSS-O twist drill**

► Technical specifications

- Special grinding:
- quiet concentricity
- no center punching
- Drilling possible on curved surfaces
- 
- Characteristics:
- HSS-O drill
- All-round drill for almost all materials
- Ground from a solid blank
- highest breaking strength for all diameters
- low chip curvature
- profile ground and right hand cutting
- 
- Point angle:
- up to 50% faster than conventional twist drills
- low energy consumption
- particularly suitable for cordless drills



Item No.	Ø mm	PU
4627-10	1,0	10
4627-15	1,5	10
4627-20	2,0	10
4627-25	2,5	10
4627-30	3,0	10
4627-33	3,3	10
4627-35	3,5	10
4627-40	4,0	10
4627-42	4,2	10
4627-45	4,5	5
4627-50	5,0	5
4627-51	5,1	5
4627-55	5,5	5
4627-60	6,0	5
4627-65	6,5	5
4627-68	6,8	5
4627-70	7,0	5
4627-75	7,5	5
4627-80	8,0	5
4627-85	8,5	5
4627-90	9,0	5
4627-95	9,5	5

Item No.	Ø mm	PU
4627-100	10,0	5
4627-102	10,2	1
4627-105	10,5	1
4627-110	11,0	1
4627-115	11,5	1
4627-120	12,0	1
4627-125	12,5	1
4627-130	13,0	1
4627-135	13,5	1
4627-140	14,0	1
4627-145	14,5	1
4627-150	15,0	1
4627-155	15,5	1
4627-160	16,0	1
4627-165	16,5	1
4627-170	17,0	1
4627-175	17,5	1
4627-180	18,0	1
4627-185	18,5	1
4627-190	19,0	1
4627-200	20,0	1

02

**Stratus HSS-O twist drill box 1.0-10.0mm**

profile ground and right hand cutting, DIN 338

- Item no. 4627-025-10 | Diameter 2.5 – 10.0 mm (0.5 mm increments)

- Item no. 4627-025-13 | Diameter 2.5 – 13.0 mm (0.5 mm increments)

► Technical specifications

- All-round drill for almost all materials
- up to 50% faster than conventional twist drills
- No center punching, drilling possible on curved surfaces
- profile ground and right hand cutting
- HSS-O drill, DIN 338
- Ground from a solid blank
- highest breaking strength for all diameters
- low chip curvature
- quiet concentricity
- low energy consumption
- particularly suitable for cordless drills



03

**Stratus set**

Drill assortment

- Item no. 1900-98
- Contents: 6-piece kit

- 1 piece 4627-20 Stratus twist drill HSS-O 2.0mm
- 1 piece 4627-30 Stratus twist drill HSS-O 3.0mm
- 1 piece 4627-40 Stratus twist drill HSS-O 4.0mm
- 1 piece 4627-50 Stratus twist drill HSS-O 5.0mm
- 1 piece 4627-60 Stratus twist drill HSS-O 6.0mm
- 1 piece 4627-80 Stratus twist drill HSS-O 8.0mm



01

**Platinum HSCO twist drill**

profile ground and right hand cutting, DIN 1921

## ► Technical specifications

- profile ground and right hand cutting
- Point angle 135 °
- good penetration behavior
- Material HSCO (special quality)
- Precision ground
- 4-surface bevel
- aggressive cutting behavior
- high stability and service life
- quiet running behavior
- high temperature resistance
- very good chip evacuation



Item No.	Ø mm	PU
4628-1-25	2,5	1
4628-1-30	3,0	1
4628-1-32	3,2	1
4628-1-35	3,5	1
4628-1-40	4,0	1
4628-1-42	4,2	1
4628-1-45	4,5	1
4628-1-50	5,0	1
4628-1-55	5,5	1
4628-1-60	6,0	1
4628-1-65	6,5	1
4628-1-68	6,8	1
4628-1-70	7,0	1

Item No.	Ø mm	PU
4628-1-75	7,5	1
4628-1-80	8,0	1
4628-1-85	8,5	1
4628-1-90	9,0	1
4628-1-95	9,5	1
4628-1-100	10,0	1
4628-1-105	10,5	1
4628-1-110	11,0	1
4628-1-115	11,5	1
4628-1-120	12,0	1
4628-1-125	12,5	1
4628-1-130	13,0	1

02

**Platinum HSCO twist drill box 2.5-10.0mm**

profile ground and right hand cutting, DIN338

## ► Item no. 4628-125-010 | Diameter 2.5-10.0 mm (0.5 mm increments)

## ► Technical specifications

- profile ground and right hand cutting, DIN338
- Material HSCO (special quality) with 5% cobalt content
- Precision ground
- Point angle 118 ° enables very good penetration behavior
- Special point thinning for optimal self-centering behavior without pre-drilling
- 4-facet bevel: ideal for high-strength tough steels, aggressive cutting behavior, reduction of the feed force by 30% due to core thinning
- high stability and service life
- quiet running behavior
- high temperature resistance
- very good chip evacuation



03

**Platinum drill set**

## ► Item no. 1900-99

## ► Contents: 6-piece kit

- Material HSCO (special quality)
- Precision ground
- Point angle 135 °
- good penetration behavior
- 4-surface bevel
- aggressive cutting behavior
- high stability and service life
- quiet running behavior
- high temperature resistance
- very good chip evacuation

## - Content:

- 1 pc. 4626-20 NIGHT LINE TWIST DRILL 2.0MM
- 1 pc. 4628-1-30 PLATINUM TWIST DRILL HSCO 3.0 MM
- 1 pc. 4628-1-40 PLATINUM TWIST DRILL HSCO 4.0 MM
- 1 pc. 4628-1-50 PLATINUM TWIST DRILL HSCO 5.0 MM
- 1 pc. 4628-1-60 PLATINUM TWIST DRILL HSCO 6.0 MM
- 1 pc. 4628-1-80 PLATINUM TWIST DRILL HSCO 8.0 MM







01

**Night Line twist drill assortment**

Basic range

► **Item no. 1957-626**► **Technical specifications**

- Characteristics:
- Profile ground
- ground from a solid blank
- HSS drill
- Suitable for hand drills
- Point angle 118 °
- relatively good penetration behavior
- reduced cross cutting edge
- high stability
- quiet running behavior

- Contents: 120 parts:
- 10 x 1.0mm (Item No. 4626-10)
- 10 x 1.5mm (Item No. 4626-15)
- 10 x 2.0mm (Item No. 4626-20)
- 10 x 2.5mm (Item No. 4626-25)
- 5 x 3.0mm (Item No. 4626-30)
- 5 x 3.5mm (Item No. 4626-35)
- 5 x 4.0mm (Item No. 4626-40)
- 5 x 4.5mm (Item No. 4626-45)
- 5 x 5.0mm (Item No. 4626-50)
- 5 x 5.5mm (Item No. 4626-55)
- 5 x 6.0mm (Item No. 4626-60)
- 5 x 6.5mm (Item No. 4626-65)
- 5 x 7.0mm (Item No. 4626-70)
- 5 x 7.5mm (Item No. 4626-75)
- 5 x 8.0mm (Item No. 4626-80)
- 5 x 8.5mm (Item No. 4626-85)
- 5 x 9.0mm (Item No. 4626-90)
- 5 x 9.5mm (Item No. 4626-95)
- 5 x 10.0mm (Item No. 4626-100)
- 5 x 10.5mm (Item No. 4626-105)
- 1 x assortment box
- 1 x inlet 20-fold



02

**Stratus twist drill range**

profile ground and right hand cutting, DIN 384

► **Item no. 1957-627-1**► **Technical specifications**

- Special grinding:
- quiet concentricity
- no center punching
- Drilling possible on curved surfaces
- 
- Characteristics:
- HSS-O drill
- All-round drill for almost all materials
- Ground from a solid blank
- highest breaking strength for all diameters
- low chip curvature
- 
- Point angle:
- up to 50% faster than conventional twist drills
- low energy consumption
- particularly suitable for cordless

drills

- 
- Content:
- 5 x 1.0 mm (Item No. 4627-10)
- 5 x 1.5 mm (Item No. 4627-15)
- 5 x 2.0 mm (Item No. 4627-20)
- 5 x 2.5 mm (Item No. 4627-25)
- 3 x 3.0 mm (Item No. 4627-30)
- 3 x 3.5 mm (Item No. 4627-35)
- 3 x 4.0 mm (Item No. 4627-40)
- 3 x 4.5 mm (Item No. 4627-45)
- 3 x 5.0 mm (Item No. 4627-50)
- 3 x 5.5 mm (Item No. 4627-55)
- 3 x 6.0 mm (Item No. 4627-60)
- 3 x 6.5 mm (Item No. 4627-65)
- 3 x 7.0 mm (Item No. 4627-70)
- 3 x 7.5 mm (Item No. 4627-75)
- 3 x 8.0 mm (Item No. 4627-80)
- 3 x 8.5 mm (Item No. 4627-85)
- 3 x 9.0 mm (Item No. 4627-90)
- 3 x 9.5 mm (Item No. 4627-95)
- 3 x 10.0 mm (Item No. 4627-100)
- 3 x 10.5 mm (Item No. 4627-105)
- 1 x assortment box
- 1 x inlet 20-fold

01

**Drilling**

Easy cut

- ▶ Item no. 2894-443
- ▶ Content: 350 ml
- ▶ Quantity per box: 12

▶ **Technical specifications**

- chip evacuation is supported
- Reduction of the friction between the drill and the workpiece
- The drill and workpiece are lubricated and cooled
- significant service life extension
- Corrosion protection for the bore



02

**Sheet metal conical drill set**

HSS

- ▶ Item no. 4694-015-45

▶ **Technical specifications**

- Point bevel: company standard
- Point thinning: DIN 1412 C
- Point angle: 118 °
- Taper angle: 20-30 °
- Ø tolerance: works standard
- Shank: 3 times the clamping surface
- Surface: blank
- right hand cutting



03

**Countersink**

HSS, DIN 335

Item No.	Ø mm	Length [mm]
4710-1-63	6,3	60
4710-1-83	8,3	60
4710-1-124	12,4	60



04

**Unibit step drill**

HSS-E

▶ **Technical specifications**

- This multi-step drill has 14 steps from 4 to 30 mm and is therefore suitable for drilling step holes.

Item No.	Size		
4691-921-304	4 - 30 mm	13	78



05

**Conical drill bits**

HSS

▶ **Technical specifications**

- Point bevel: company standard
- Point thinning: DIN 1412 C
- Point angle: 118 °
- Taper angle: 20-30 °
- Ø tolerance: works standard
- Shank: 3 times the clamping surface
- Surface: blank
- right hand cutting
- Shank Ø: 6 mm

Item No.	Size		
4694-015-41	Size 1: 3 – 14.0 mm	6	58
4694-015-42	Size 2: 5 – 20.0 mm	8	71
4694-015-43	Size 3: 16 – 30.5 mm	9	76
4694-015-44	Size 4, 24 - 40.0 mm	10	89
4694-015-46	Size 5, 36 - 50.0 mm	12	97



06

**Unidrill conical drill bit HSS**

HSS, ground with cross point

▶ **Technical specifications**

- HSS
- ground with cross point
- Shank: 3 times the clamping surface
- Point bevel: company standard
- Point thinning: DIN 1412 C
- Point angle: 118 °
- Taper angle: 20-30 °
- Ø tolerance: works standard
- Surface: blank
- right hand cutting
- Diameter: 5mm-31mm

Item No.	Size		
4691-921-495	5-31 mm, d2 = 9 mm, l1= 103 mm		9



103





02

**Carbide cutter**

Cylindrical shape with spur teeth

► **Technical specifications**

- The burrs made of high-performance carbide offer the highest cutting edge stability and high toughness of the cutting edges.
- The titanium-carbon-nitride wear protection coating increases the surface hardness of the tool to approx. 3,000 HV / micro hardness and the hot hardness resistance up to 400 ° C. This increases the service life and increases productivity.



Item No.	Shaft Ø [mm]				PU
4681-061-06	6	6	58	18	1
4681-161-019	10	6	60	20	1

01

**Carbide cutter set**

► **Item no. 4694-016-5**

► **Technical specifications**

- Carbide burrs in different designs
- Recording 6 mm
- 
- Content:
- 1x cylinder cutter Ø 10 mm
- 1x round arch cutter Ø 10 mm
- 1x round arch cutter Ø 12 mm
- 1x pointed arch cutter Ø 12 mm
- 1x conical cutter Ø 12 mm



03

**Carbide cutter**

Spherical shape



Item No.	Shaft Ø [mm]				PU
4681-161-021	10	6	49	9	1

01

**Carbide cutter**  
Pointed arch shape

► **Technical specifications**

- The burrs made of high-performance carbide offer the highest cutting edge stability and high toughness of the cutting edges.
- The titanium-carbon-nitride wear protection coating increases the surface hardness of the tool to approx. 3,000 HV / micro hardness and the hot hardness resistance up to 400 ° C. This increases the service life and increases productivity.



Item No.	Shaft Ø [mm]				PU
4681-661-325	6	12	65	25	1
4681-061-08	6	6	58	18	1

02

**Carbide cutter**  
Round arch shape



Item No.	Shaft Ø [mm]				PU
4681-161-020	10	6	60	20	1
4681-061-07	6	6	58	18	1
4681-661-326	12	6	65	25	1

03

**Carbide cutter**  
Roll round shape



Item No.	Shaft Ø [mm]				PU
4681-161-022	10	6	60	20	1
4681-061-10	6	6	56	10	1

04

**Carbide cutter**  
Pointed cone shape



Item No.	Shaft Ø [mm]				PU
4681-061-09	6	6	58	18	1
4681-661-327	12	6	65	25	1



01

**Spot weld milling machine**

D-5120C

▶ Item no. 8696-112-915

▶ Technical specifications

- Idle speed: 600rpm
- Weight: 2.2 kg
- Air pressure: 6.3 bar
- Compressed air connection: 1/4 "

- low heat generation
- little influence on the surface tension = less distortion on the surface to be processed
- precise cutting
- longer service life of the drill, thus higher economic efficiency
- Minimizing the risk of breaking tips and flanks on the drill
- is particularly suitable for use on high-strength sheets

- Patented pneumatic drill spindle feed for constant contact pressure
- Removable bracket for internal and external welding points

- PLEASE NOTE: This article is excluded from the loyalty offer!



02

**Solid carbide milling cutter**

▶ Technical specifications

- 3-edged
- for high-strength sheets (materials)
- for spot weld milling machine



Item No.	Ø mm	Length [mm]
4710-008-044	8	44
4710-008-046	8	46

03

**Spot weld milling cutter**

HSCO, drill bit Ø: 8.0mm, length: 46mm, PU: 10



Item No.	Ø mm	Length [mm]
4710-112-900	8	46

04

**Spot weld drill**

HSS for drilling machine



Item No.	Ø mm	Length [mm]
4710-6	6	60
4710-8	8	60
4710-10	10	60

05

**Welding spot drill**

with multi-layer coating



▶ Technical specifications

- special multi-layer coating
- Application temperature is max. 800 °C
- Coefficient of friction of 0.6

Item No.	Ø mm	Length [mm]
4710-206	6	70
4710-208	8	80
4710-210	10	90

06

**Spot weld milling cutter**

HSS for drilling machine

▶ Item no. 4698-1

▶ Technical specifications

- Total length: 72 mm
- Drill Ø: 10.0 mm
- right hand cutting

**Replacement milling crown for spot weld milling cutters**

HSS for drilling machine

▶ Item no. 4698-01



01

**Tinning paste**

- ▶ Item no. 4982-91
- ▶ Content: 1 kg
- ▶ Quantity per box: 1

## ▶ Technical specifications

- is applied before the actual tinning in order to give the body tin an optimal primer on the metal
- cleans and degreases
- lead-free

02

**solder**

Bar, pressed

- ▶ Item no. 4982-1
- ▶ Content: 5 kg (5 x 1kg bars)

## ▶ Technical specifications

- PB (lead): 74%
- SN (tin): 25%
- SB (antimony): 1%
- Standard designation: DIN EN 29453?
- Packaging unit: 5 kg (5 x 1kg rods)



03

**Fuel gas**

Extra hot

- ▶ Item no. 8714-608-600
- ▶ Content: 600 ml
- ▶ Quantity per box: 12

## ▶ Technical specifications

- max.temperature 2,000 ° C
- a mixture of propane, butane, acetone and isobutane
- extra hot
- suitable for tinning and brazing



04

**Piezo Ignition Burner Nozzle**

- ▶ Item no. 8714-609-3

## ▶ Technical specifications

- Temperatures between 750 ° C and 1900 ° C possible
- ergonomic handle
- infinitely adjustable
- easy handling
- for all cartridges with 7/16 "thread
- Usable 360 °





01

**Tinsol is the new repair method for metal bodywork.**

250 ml

- ▶ Item no. 2893-224-2
- ▶ Content: Size 10
- ▶ Quantity per box: 12

▶ **Technical specifications**

- moisture and weather resistant
- temperature resistant from -30 ° C to 120 ° C (briefly up to 180 ° C).
- Pot life at 23 ° C is 50 minutes

- Tinsol Plus is a cold-applied, two-component, high-strength body leveling compound based on epoxy resin, for the repair of steel and aluminum surfaces. Tinsol Plus is used as a pure alluvial tin substitute for non-deformable deformations and as a lead-free tin solder substitute to compensate for damaged areas and weld seams.

- The unique tin-free, paste-like recipe is easy to spread, easy to model and, after hardening, can be sanded. The pot life at 23 ° C is 50 minutes. Tinsol Plus is moisture and weather resistant and has a temperature resistance of -30 ° C to 120 ° C (short term up to 180 ° C).



02

**Hand mixer, angular**  
for Tinsol Plus

- ▶ Item no. 2893-223-39
- ▶ PU: 5



03

**High temperature protective blanket**

- ▶ Item no. 4982-001

▶ **Technical specifications**

- suitable for use in grinding and bodywork
- resistant to sparks and slag
- Dimensions: 160 x 230 cm with fastening straps
- Material: glass filament fabric (flame retardant, non-flammable)
- Weight: 3.5 kg
- Thickness: 0.5mm
- Heat resistance: up to 750 ° C
- Elongation at break: 3%



04

**Welding blanket**

- ▶ Item no. 4982-000

▶ **Technical specifications**

- Dimensions: 229 x 188.5 cm
- Heat resistance: up to 700 ° C
- max. radiation temperature: up to 1,000 ° C
- abrasion and kink resistant





01

**Welding gloves**

Full and split leather Gr. XXL / 10

- ▶ Item no. 7798-012-10
- ▶ Quantity per box 6/72
  
- ▶ Technical specifications
  - 5-finger welding glove
  - Full / split leather combined
  - Split cuff
  - Length: 35 cm?
  - Certification
  - EN 388, EN 12477, TÜV / GS



02

**Welding glove "NEW FIRE"**

Nappa leather size XXL/10 Item no. 7798-034-10

- ▶ Quantity per box 6/72
  
- ▶ Technical specifications
  - Nappa leather, gray
  - Split leather cuff, yellow
  - Length 35 cm
  - inserted thumb



03

**Welding goggles**

foldable

- ▶ Item no. 4695-006-460
  
- ▶ Technical specifications
  - These glasses with a foldable front part ensure a safe view when welding

**Replacement glass**

- ▶ Item no. 4695-006-461
- ▶ PU: 10
- ▶ colorless, splinter-free
  
- ▶ Item no. 4695-006-465
- ▶ PU: 10
- ▶ clear, athermal



01

**Automatic protection shield**

Carbon look

▶ Item no. 4695-007-100

▶ Technical specifications

- Anti-glare cassette: 1/1/1/2 shade levels  
DIN 4 / 5-8 and 9-13
- TIG suitable from 5 amps grinding mode
- large field of view 53 x 100 mm
- four independent sensors continuously adjustable
- Power supply with solar cell

**Cover plate**

for (4695-007-100)

▶ Item no. 4695-007-110

▶ PU: 5



02

**Hand protection shield**

90 x 110, without glass

▶ Item no. 4695-006-440

▶ Technical specifications

- Conditionally heat-resistant hand protection shield without an additional lens
- the clear and green front panels are interchangeable

**Cover plate**

▶ Item no. 4695-006-442

▶ Colour: clear

▶ PU: 5

▶ Item no. 4695-006-446

▶ Colour: green

▶ PU: 5







01  
**Torch hose package 150 A**  
for standard MIG / MAG welding torches

- ▶ Item no. 4983-101 | Length: 3 m
- ▶ Item no. 4983-101-5 | Length: 5 m
- ▶ Technical specifications
  - Cooling: air cooling
  - Wire diameter: 0.6 to 1.0 mm
  - Gas flow: 8 l / min.
  - Torch neck: rigid design
  - System for plugged gas nozzles
  - Contact nozzle: 1.2 mm
  - Cable: Flex rubber coax cable
  - Technical design: according to IEC 60974-7
  - Weight with 5 meters of cable: 2.800 kg
  - Connection: Euro central plug
  - Load capacity at 60% ED (10 minute cycle)
    - with mixed gas 150 A.
    - at CO<sup>2</sup> 180 A



02  
**Burner tube 150 A**  
rigid, pluggable

- ▶ Item no. 4983-112



03  
**Burner tube 150 A**  
flexible, plugged

- ▶ Item no. 4983-113



04  
**Red guide spiral**  
red

- ▶ Item no. 4983-101-51
- ▶ Technical specifications
  - 5 meters long
  - for currents up to 250 amps
  - for wire thicknesses from 0.8 to 1.2 mm



05  
**150 A nozzle assembly**  
M6

- ▶ Item no. 4983-110
- ▶ Technical specifications
  - suitable for: 4983-101, 4983-101-5, 4983-112



06  
**Spot welding nozzle 150 A**  
pluggable

- ▶ Item no. 4983-103



07  
**Gas nozzle spring inserted**  
for plugged-in burner systems 150 A

- ▶ Item no. 4983-109

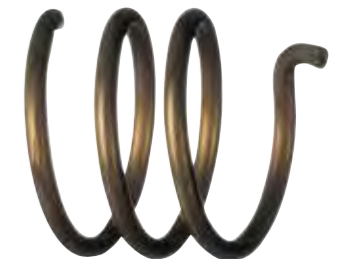

08  
**Gas nozzle 150A**  
conic



09  
**Current nozzle 150A**  
nickel-plated



Item No.	connection	PU	Item No.	Ø mm	PU
4983-102	pluggable	1	4983-105-008	0,8	10
4983-102-1		1	4983-105-010	1,0	10





**01 Torch hose package**  
for standard MIG / MAG welding torches

► Item no. 4983-250 | Length: 5 m

- Technical specifications
- Cooling: air cooling
- Wire diameter: 0.8 to 1.2 mm
- Gas flow: 10 liters / minute
- Torch neck: rigid design
- System for plugged gas nozzles
- Cable: Flex rubber coax cable
- Technical design: according to IEC 60974-7
- Weight with 5 meters of cable: 3.600 kg
- Connection: Euro central plug
- Load capacity at 60% ED (10 minute cycle)
- with mixed gas 200A
- at CO<sup>2</sup>230A



**02 Burner tube 250 A**  
flexible, plugged

► Item no. 4983-251-2



**04 Nozzle holder 250 A**  
for plugged gas nozzles

► Item no. 4983-110-1

- Technical specifications
- M6
- for plugged gas nozzles
- for currents up to 250 amps



**06 Gas nozzle 250A**  
conic



Item No.	connection	PU
4983-252	pluggable	1
4983-252-1		1

**03 Red guide spiral**  
red

► Item no. 4983-101-51

- Technical specifications
- 5 meters long
- for currents up to 250 amps
- for wire thicknesses from 0.8 to 1.2 mm



**05 Gas nozzle spring inserted**  
for plugged burner systems 250 A

► Item no. 4983-253

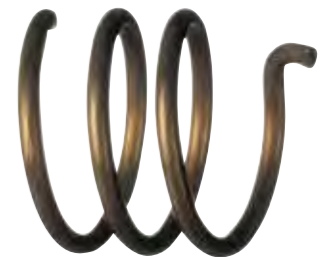

**07 Current nozzle 250A**  
nickel-plated



Item No.	Ø mm	PU
4983-255-008	0,8	10
4983-255-010	1,0	10

01  
**Inert gas welding wire**



02  
**adapter**  
for basket bobbins



► Item no. 4982-008-100

Item No.	Ø mm	Application area	Suitable for	Weight kg
4982-018	0,8			15
4982-008	0,8		steel	15
4982-010	1,0		steel	15
4982-012	1,2		steel	15

03  
**Autogenous welding wire**  
Rod, G1



► Item no. 4982-002

04  
**Corrugated wire**  
for 6 "claw

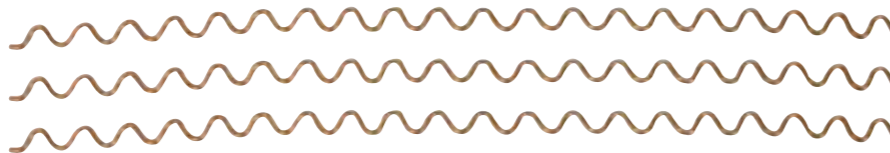

► Item no. 8714-821-079

- Technical specifications
- Length: 360 mm
  - Diameter: 2mm

05  
**Stick electrodes**  
Overcord



- Technical specifications
- Medium-thick coated rutile cellulose electrode
  - particularly suitable for welding vertical-down seams
  - 
  - Characteristics:
  - Line limit ReH N / qmm > 380
  - Tensile strength Rm N / qmm 470-600
  - Elongation at break A5% > 20
  - Impact work (ISO-V) 20 ° C J 80
  -

Approvals:

Item No.	Length [mm]	PU
4982-044-152	2,5	350
4982-044-158	3,2	350

06  
**Stick electrodes**  
Fincord, rutile type



- Technical specifications
- thick coated rutile cellulose electrode
  - low spattering
  - can be welded in all positions, except falling
  - 
  - Characteristics:
  - Line limit ReH N / qmm > 420
  - Tensile strength Rm N / qmm 500-640
  - Elongation at break A5% > 20

Item No.	Length [mm]	PU
4982-044-147	2,5	350

07  
**Weld-on nails**



Item No.	Ø mm	PU
8714-821-077	2,0	1000
8714-821-078	2,6	1000

08  
**Washers blank**  
Steel untreated



Item No.	Ø mm	PU
6405-8	8,0	100



01

**Soft foam board, foam sound insulation boards**

Foam soundproofing panels

- ▶ Item no. 4580-774
- ▶ PU: 6
- ▶ Technical specifications
  - Temperature resistance: from -25 ° C to 90 ° C
  - abrasion-resistant surface
  - Dimensions: 550 x 250 x 10 mm
  - Color anthracite
  - PU: 6

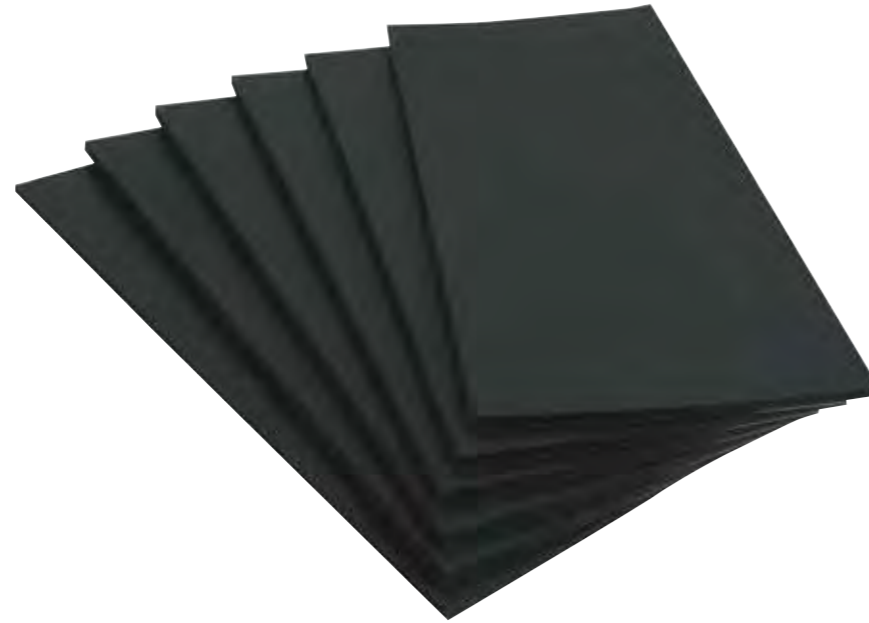

02

**Sound insulation board, bitumen**

Bitumen

- ▶ Item no. 4580-773
- ▶ PU: 6
- ▶ Technical specifications
  - Temperature resistance: up to 90 ° C
  - Color: Black
  - Dimensions: 550 x 250 x 2 mm
  - PU: 6

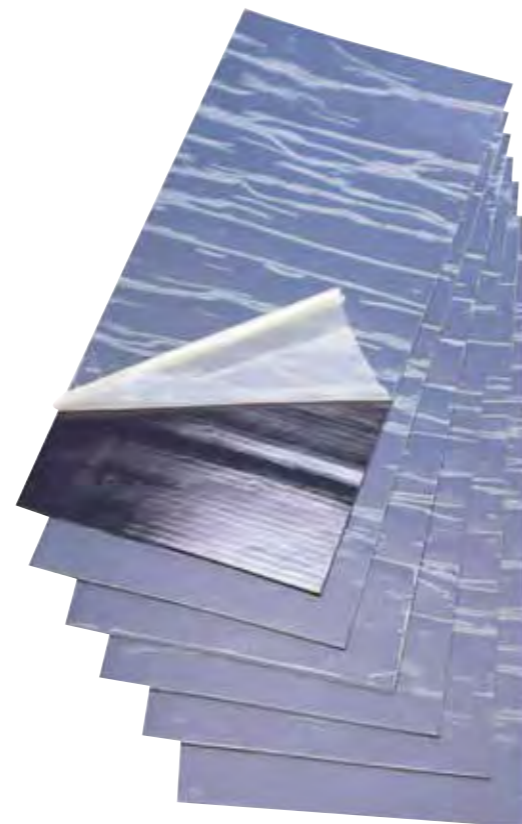

03

**Permanently plastic sealing tape**

- ▶ Item no. 4581-770
- ▶ Technical specifications
  - flat
  - Roll length: 26 m
  - solvent-free
  - temperature, aging and weather resistant
  - Temperature resistance from -30 ° C to 100 ° C
  - Eliminates annoying body noises
  - Dimensions: 20 x 2 mm



04

**Butyl tape roll**

Permanently plastic sealing tape, black

- ▶ Item no. 4581-777
- ▶ Technical specifications
  - Eliminates annoying body noises
  - Ø round cord: 8 mm
  - Length: 10 m



01

**High performance assembly line**

► Technical specifications

- silicone free
- double-sided, pressure-sensitive acrylic high-performance adhesive tape
- very high transparency
- very suitable for gluing glass and various transparent plastics
- thin or structured surfaces can be glued over the entire surface and without tension
- very well suited to compensate for differences in expansion between the different materials
- good impact resistance
- Vibration dampening
- sealing
- very good resistance to weathering, aging, yellowing (UV influences)
- for moldings



Item No.	Width (mm)	Length [m]	PU
4991-306	6	10	1
4991-312	12	10	1
4991-319	19	10	1
4991-324	24	10	1

02

**Moulding adhesive tape**

► Technical specifications

- Color: Black
- double-sided adhesive
- high final strength



Item No.	Width (mm)	Length [m]	PU
4991-06	6	10	1
4991-12	12	10	1
4991-19	19	10	1
4991-24	24	10	1

03

**Adhesive tape for protective films**

► Technical specifications

- Color: transparent
- double-sided adhesive

Item No.	Width (mm)	Length [m]	PU
4991-50-19	19	50	1
4991-50-38	38	50	1



04

**Tinted self-adhesive protective film**

0.6 x 100 meters, thickness 90µ

► Item no. 7991-100

► Technical specifications

- Can also be used as a door lining film







01

**Blind rivets**

DIN 7337, rivet sleeve: steel, galvanized / rivet mandrel: steel, galvanized



Item No.	Rivet sleeves Ø mm	Rivet sleeves Length mm	Drill Ø mm	Rivetable material thickness	Head Ø mm	Head height mm	PU
5938-48-8	4,8	8	4,9	2,5 - 4,5	9,5	1,1	100
5938-48-12	4,8	12	4,9	6,0 - 8,0	9,5	1,1	100
5938-48-14	4,8	14	4,9	8,0 - 10,0	9,5	1,1	100
5938-48-16	4,8	16	4,9	10,0 - 11,5	9,5	1,1	100
5938-64-12	6,4	12	6,5	3,0 - 6,0	13	1,8	100
5938-64-15	6,4	15	6,5	6,0 - 9,0	13	1,8	100
5938-64-18	6,4	18	6,5	9,0 - 12,0	13	1,8	100
5938-64-22	6,4	22	6,5	12,0 - 16,0	13	1,8	100

02

**Blind rivets**

Rivet sleeve: aluminum alloy

Rivet mandrel: aluminum alloy

## ► Technical specifications

- Excellent for attaching various interior bumper parts
- suitable for soft material
- Spreading form



Item No.	Rivet sleeves Ø mm	Rivet sleeves Length mm	Drill Ø mm	Rivetable material thickness	Head Ø mm	Head height mm	PU
5937-048-205	4,8	20,5	4,3	3,0 - 9,0	8,0	1,6	100

03

**Blind rivets**

Rivet sleeve: aluminum alloy Rivet mandrel: steel, zinc-plated

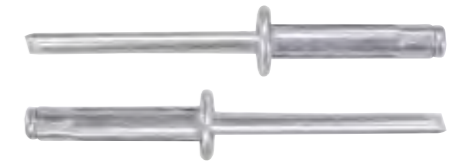

## ► Technical specifications

- DIN 7337
- Rivet sleeve: aluminum alloy
- Rivet mandrel: galvanized steel

Item No.	Rivet sleeves Ø mm	Rivet sleeves Length mm	Drill Ø mm	Rivetable material thickness	Head Ø mm	Head height mm	PU
5937-24-6	2,4	6,0	2,4	2,0 - 4,0	5,0	0,6	100
5937-24-8	2,4	8,0	2,4	4,0 - 6,0	5,0	0,6	100
5937-3-6	3,0	6,0	3,1	1,5 - 3,5	6,5	0,8	100
5937-3-8	3,0	8,0	3,1	3,5 - 5,5	6,5	0,8	100
5937-3-10	3,0	10,0	3,1	5,6 - 7,0	6,5	0,8	100
5937-3-16	3,0	16,0	3,1	9,0 - 13,0	6,5	0,8	100
5937-32-10	3,2	10,0	3,3	5,5 - 7,0	6,5	0,8	100
5937-4-6	4,0	6,0	4,1	0,5 - 3,0	8,0	1,0	100
5937-4-8	4,0	8,0	4,1	3,0 - 5,0	8,0	1,0	100
5937-4-10	4,0	10,0	4,1	5,0 - 6,5	8,0	1,0	100
5937-4-12	4,0	12,0	4,1	6,5 - 8,5	8,0	1,0	100
5937-4-16	4,0	16,0	4,1	8,5 - 12,5	8,0	1,0	100
5937-4-20	4,0	20,0	4,1	12,0 - 16,0	8,0	1,0	100
5937-48-10	4,8	10,0	4,9	4,5 - 6,0	9,0	1,1	100
5937-48-16	4,8	16,0	4,9	6,0 - 12,0	9,0	1,1	100
5937-5-8	5,0	8,0	5,1	3,0 - 4,5	9,0	1,1	100
5937-5-10	5,0	10,0	5,1	4,5 - 6,0	9,0	1,1	100
5937-5-12	5,0	12,0	5,1	6,0 - 8,0	9,0	1,1	100
5937-5-16	5,0	16,0	5,1	8,0 - 12,0	9,0	1,1	100
5937-5-20	5,0	20,0	5,1	12,0 - 16,0	9,0	1,1	100
5937-5-25	5,0	25,0	5,1	16,0 - 21,0	9,0	1,1	100
5937-5-40	5,0	40,0	5,1	30,0 - 35,0	9,0	1,1	100
5937-6-8	6,0	8,0	6,1	3,0 - 4,5	12,0	1,5	100
5937-6-10	6,0	10,0	6,1	4,5 - 6,0	12,0	1,5	100
5937-6-12	6,0	12,0	6,1	6,0 - 8,0	12,0	1,5	100
5937-6-16	6,0	16,0	6,1	8,0 - 12,0	12,0	1,5	100
5937-6-20	6,0	20,0	6,1	12,0 - 16,0	12,0	1,5	100
5937-6-25	6,0	25,0	6,1	16,0 - 21,0	12,0	1,5	100

01

**Blind rivets**

Rivet sleeve: aluminum alloy

Rivet mandrel: aluminum alloy

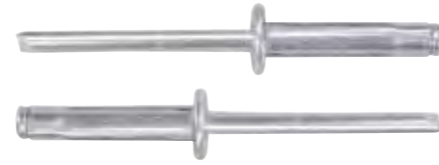

► Technical specifications

- DIN 7337
- Rivet sleeve: aluminum alloy
- Rivet mandrel: galvanized steel

Item No.	Rivet sleeves Ø mm	Rivet sleeves Length mm	Drill Ø mm	Rivetable material thickness	Head Ø mm	Head height mm	PU
5937-040-188	4,0	18,8	4,2 - 4,4	3,0 - 7,0	8,0	≤ 1,7	100

02

**Sealing blind rivet**

Rivet sleeve: aluminum alloy

Rivet mandrel: steel lightly greased



Item No.	Rivet sleeves Ø mm	Rivet sleeves Length mm	Drill Ø mm	Rivetable material thickness	Head Ø mm	Head height mm	PU
5937-048-12	4,8	12,5	4,9	6,5-8	9,5		100

03

**Expanding blind rivets, aluminum**

Rivet sleeve: aluminum alloy

Rivet mandrel: galvanized steel



Item No.	Rivet sleeves Ø mm	Rivet sleeves Length mm	Drill Ø mm	Rivetable material thickness	Head Ø mm	Head height mm	PU
5937-004-821	4,8	21,0	4,9	8,0 - 15,0	9,5	1,0	100

04

**Blind rivets**

Rivet sleeve: aluminum, rivet mandrel: steel, galvanized



Item No.	Rivet sleeves Ø mm	Rivet sleeves Length mm	Drill Ø mm	Rivetable material thickness	Head Ø mm	Head height mm	PU
5944-4-85	4,0	8,5	4,1	4,5 - 6,0	12,0	1,4	100
5944-11-8	5,0	8,0	5,1	0,5 - 4,5	11,0	1,5	100
5944-11-10	5,0	10,0	5,1	4,5 - 6,0	11,0	1,5	100
5944-11-12	5,0	12,0	5,1	6,0 - 8,0	11,0	1,5	100
5944-11-16	5,0	16,0	5,1	8,0 - 12,0	11,0	1,5	100
5944-11-20	5,0	20,0	5,1	12,0 - 16,0	11,0	1,5	100
5944-11-25	5,0	25,0	5,1	16,0 - 21,0	11,0	1,5	100
5944-11-30	5,0	30,0	5,1	21,0 - 25,0	11,0	1,5	100
5944-14-8	5,0	8,0	5,1	0,5 - 4,5	14,0	1,5	100
5944-14-10	5,0	10,0	5,1	4,5 - 6,0	14,0	1,5	100
5944-14-12	5,0	12,0	5,1	6,0 - 8,0	14,0	1,5	100
5944-14-16	5,0	16,0	5,1	8,0 - 12,0	14,0	1,5	100
5944-14-20	5,0	20,0	5,1	12,0 - 16,0	14,0	1,5	100

05

**Blind rivets**

with buttonhead / according to DIN 7337? rivet sleeve: aluminum, painted black  
rivet mandrel: steel, galvanized



Item No.	Rivet sleeves Ø mm	Rivet sleeves Length mm	Drill Ø mm	Rivetable material thickness	Head Ø mm	Head height mm	PU
5937-32-751	3,2	7,5	3,3	3,0 - 5,5	9,5	1,2	100
5937-4-81	4,0 (VW)	8,0	4,1	3,0 - 5,5	12,0	1,5	100
5937-4-141	4,0 (VW)	14,0	4,1	7,5 - 11,0	12,0	1,5	100
5937-48-141	4,8	14,0	4,9	7,5 - 11,0	12,0	1,8	100





01

**Assortment of blind rivets**

DIN 7337, rivet sleeve: aluminum alloy, rivet mandrel: galvanized steel

► Item no. 1957-937-1

► Contents: 800 parts

- 100 x 3x6 (Item No. 5937-3-6)
- 100 x 3x8 (Item No. 5937-3-8)
- 100 x 4x10 (Item No. 5937-4-10)
- 100 x 4x12 (Item No. 5937-4-12)
- 100 x 4x6 (Item No. 5937-4-6)
- 100 x 4x8 (Item No. 5937-4-8)
- 100 x 3x10 (Item No. 5937-3-10)
- 100 x 4x16 (Item No. 5937-4-16)



02

**Blind-rivet nuts**

Buttonhead, aluminum



Item No.	Rivet sleeves Ø mm	Rivet sleeves Length mm	Drill Ø mm	Rivetable material thickness	Head Ø mm	Head height mm	PU
5948-14-20	M4	6,0	10,0	8,0	≤ 0,8	0,5 - 3,0	100
5948-15-30	M5	7,0	11,0	10,0	≤ 1,0	0,5 - 3,0	100
5948-16-30	M6	9,0	16,0	12,0	≤ 1,0	0,5 - 3,0	100
5948-18-30	M8	11,0	16,5	12,5	≤ 1,5	0,5 - 3,0	100
5948-18-55	M8	11,0	20,0	15,0	≤ 1,5	3,0 - 5,5	100
5948-10-175	M10	13,0	25,0	20,0	≤ 1,5	3,0 - 5,5	50



01

**Blind-rivet nuts**

Hexagonal, galvanized steel



Item No.	Rivet sleeves Ø mm	Rivet sleeves Length mm	Drill Ø mm	Rivetable material thickness	Head Ø mm	Head height mm	PU
5950-5-13	M5	7,0	13,0	10,0	≤ 1,0	0,7 - 3,0	50
5950-6-145	M6	9,0	16,0	13,0	≤ 1,5	0,5 - 3,0	25

02

**Blind-rivet nuts**

galvanised steel, with flat head



Item No.	Rivet sleeves Ø mm	Rivet sleeves Length mm	Drill Ø mm	Rivetable material thickness	Head Ø mm	Head height mm	PU
5949-4-115	M4	6,0	11,0	9,0	1,1	0,5 - 3,0	100
5949-5-12	M5	7,0	14,0	10,0	1,1	0,5 - 3,0	100
5949-6-145	M6	9,0	16,0	12,0	1,6	0,5 - 3,0	100
5949-8-16	M8	11,0	17,5	15,0	1,6	0,5 - 3,0	100
5949-8-185	M8	11,0	20,0	15,0	1,6	3,0 - 5,5	100
5949-10-17	M10	12,0	19,0	16,0	2,1	0,5 - 3,0	50
5949-10-22	M10	12,0	24,0	16,0	2,1	3,0 - 6,0	50
5949-12-23	M12	16,0	25,0	22,0	2,1	1,0 - 4,0	50



03

**Assortment of blind rivet nuts**

aluminum

► Item no. 1957-948

► Contents: 600 parts

- 100 x M4x6 aluminum (item no. 5948-14-20)
- 100 x M5x7 aluminum (item no. 5948-15-30)
- 50 x M6x9 aluminum (item no. 5948-16-30)
- 50 x M8x11 aluminum (item no. 5948-18-30)
- 100 x M4x6 steel (item no. 5949-4-115)
- 100 x M5x7 steel (item no. 5949-5-12)
- 50 x M6x9 steel (item no. 5949-6-145)
- 50 x M8x11 steel (item no. 5949-8-185)



01

**Mavro blind rivet nut pliers**

Including M6, M8, M10, M12 threaded mandrels and nuts

► Item no. 8948-800

► Technical specifications

- Hand tool for processing blind rivet nuts
- readable stroke scale
- little effort required
- Setting the rivet in hard-to-reach places
- Quick change system for mandrels and sleeves
- for processing blind rivet nuts M6 M8 M10 M12 aluminum / steel / stainless steel
- Working range: up to Ø 12 mm
- Weight: 1.1 kg
- Total length: 210 mm
- 
- Areas of application:
- e.g. : convertible roof fastenings, roof rails, AUDI license plate amplifiers, flaps on truck rear doors, truck door hinges, everywhere in vehicle construction for special vehicles and superstructures, assembly of various reinforcement plates on car bodies and machines, caravan construction etc.



02

**Threaded mandrel and nut**

for blind rivet nut pliers 8948-800



Item No.	execution	PU
8948-800-14	M4	1
8948-800-15	M5	1
8948-800-16	M6	1



01

**Hand riveter NTX**

Working area up to 5 mm Ø

▶ Item no. 8949-11

▶ Technical specifications

- Weight: 1.85 kg
- Total length: 570 mm
- Device stroke: 10 mm
- Working range: up to 5 mm Ø aluminum and up to 4 mm Ø stainless steel

- 
- Equipment and accessories:
- Mouthpieces 10/18, 10/24, 10/32
- Assembly key



02

**Lever riveter**

Working area up to Ø 6.4 mm

▶ Item no. 8949-20

▶ Technical specifications

- Weight: 1.85 kg
- Total length: 570 mm
- Device stroke: 10 mm
- Working range: up to 6.4 Ø mm all materials

- 
- Equipment and accessories:
- Mouthpieces 16/29, 16/32, 16/36, 16/40, 16/45
- Rivet mandrel collector



03

**Blind rivet pliers**

Working area up to Ø 4.8 mm

▶ Item no. 8949-50

▶ Technical specifications

- Head design: rotates 360 °
- Length: 250 mm
- Width: 355 mm
- Height: 30mm
- Weight: 0.818 kg



04

**Universal combination scissors**

▶ Item no. 8714-05

▶ Technical specifications

- particularly stable design
- cuts sheet metal, wire, plastic, rubber, leather, cardboard, paper, carpeting, flowers, twigs, etc.
- practical one-hand closure made of metal





## Abbreviations for clips and clamps

### Material

Code	Designation	Code	Designation
1.4301	Stainless steel 1.4301	PA 622	Polyamide 622
1.4303	Stainless steel 1.4303	PA 623	Polyamide 623
1.4310	Stainless steel 1.4310	PA 66	Polyamide 66
1.4401	Stainless steel 1.4401	PA 661	Polyamide 661
1.4405	Stainless steel 1.4405	PA 662	Polyamide 662
A2	Stainless steel A2	PA 668	Polyamide 668
A4	Stainless steel A4	PA GF	Polyamide fibreglass-reinforced
ABS	Acrylonitrile butadiene styrene	PBT HI	Polybutylene terephthalate HI
AL	Aluminium	PE	Polyethylene
C 45	Spring steel C 45	PE 181	Polyethylene 181
C 75	Spring steel C 75	PE 271	Polyethylene 271
CK 67	Spring steel CK 67	PE 302	Polyethylene 302
CU	Copper	PE 750	Polyethylene 750
CUSN	Bronze	PE HD	Polyethylene high density
CUZN	Brass	PE LD	Polyethylene low density
EBA	Ethylene butylacrylate copolymer	PEE 526	Polyether ester 526
KOMBI	Combi-material	PEE 724	Polyether ester 724
M	Q&T steel	PES	Polyester
PA	Polyamide	POM 509	Polyoxymethylene 509
PA 12	Polyamide 12	PP	Polypropylene
PA 122	Polyamide 122	PPN	Polypropylene
PA 124	Polyamide 124	PPO	Polyphenylene oxide
PA 6	Polyamide 6	PVC	Polyvinylchloride
PA 601	Polyamide 601	SEBS	Styrene-ethene-butene-styrene
PA 607	Polyamide 607	TPC	Thermoplastic copolyester
		TPE	Thermoplastic elastomer
		UP	Unsaturated polyester
		VELOUR PA	Velours polyamide

### Colour

















Code	Designation	Code	Designation
ANT	Anthracite	L	Purple
B	Blue	N	Neutral
BE	Beige	OR	Orange
BL	Natural colour	R	Red
BR	Brown	RO	Pink
DG	Dark grey	S	Black
G	Grey	W	White
GR	Green	Y	Yellow
HG	Light grey		

## Abbreviations for clips and clamps















### Surface metal

Code	Designation	Code	Designation
BL	Natural colour	PHO SW	Phosphated black
BR	Burnished	POL	Polished
CHEM SW	Chemically dyed black	ROH	Raw
CR	Chrome-plated	SI	Silver
DAC	Dacromet	SN	Tin-plated
DELTA PROT	Delta Protpekt	TAUCHPARAF	Dip-paraffined
DELTA SEAL	Delta Seal	VK	Copper-plated
GEBEIZT	Stained	VZ	Zinc-plated
GEBÖRDELT	Flanged	VZ FL	Zinc-plated colourless
GEO 321	Geomet 321	VZ FL NTL	Zinc-plated colourless post-dip solution
GEÖLT	Oiled	VZ FL PASS	Zinc-plated colourless passivated
GL	Shiny	VZ FL PASS MATT	Zinc-plated colourless passivated matt
GZ	Gliding additive	VZ GL	Zinc-plated shiny
IMP	Impregnated	VZ MATT	Zinc-plated matt
LACK	Painted	VZ NTL	Zinc-plated post-dip solution
MAGNI 565	MAGNI 565 silver	VZG3	Zinc-plated yellow chrome-3
MAGNI 511	MAGNI 511	VZS3	Zinc-plated black chrome-3
MIC 200	Microcor 200	VZSO	Zinc-plated organic black
MKB ANT MKB	anthracite	ZN FE SW	Zinc iron black
MKB SI MKB	(metal-containing anti-corrosion coating silver)	ZN NI	Zinc nickel
MKB SI GZ MKB	(metal-containing anti-corrosion coating) silver		
MKB SW MKB	(metal-containing anti-corrosion coating) black		
MKB SW GZ MKB	(metal-containing anti-corrosion coating) black		
NI	Nickel-plated		
OX	Oxidised		
PA BES.	PA Coated unsmoothed		
PHO	Phosphated		
PHO GEÖLT	Phosphated oiled		
PHO IMP	Phosphated impregnated		
PHO LACK	Phosphated painted		
PHO LACK SW	Phosphated painted black		
PHO LACK SW IMP	Phosphated painted black impregnated		
PHO PARAF	Phosphated paraffined		

## Clips



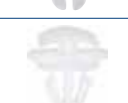













Item No.	Item designation	Original No. 1	Original No. 2	image
5500-110-64	Plastic nut m5 pa 6 gf 30 black	171201969	1229061	
5500-110-112	Cover plug Ø 8.1 - 8.3 mm PA 66 black		25186729901C	
5500-110-68	Plastic expanding rivet ø 8.0 mm pa 66 black	2E1857784	A0009913940	
5500-110-111	Plastic expanding rivet Ø 5.0 - 5.7 mm PA 6 black	N0385053	N0385051	
5500-110-142	Screw rivet black	7H0867299		
5500-110-129	Fastening clip black	701805163		
5500-110-144	Screw black	N90739704		
5500-110-108	Fir tree clip Ø 7.9 - 8.1 mm PE LD black	191867199		
5500-110-107	Grommet PE LD colourless	477857821		
5501-107-107	Decorative trim clip Pom pink	7703077421		
5500-110-97	Collar screw 4.8 x 16 zn ni sw	N90648704		
5500-110-93	Screw rivet ø 8.0 mm pa 66 black	70186729901C	-	
5500-110-143	Screw black	N10512701		
5500-110-126	Plastic nut black	N90757901		
5500-110-127	Trim clip white	2E1867289C		
5500-110-128	Screw rivet with hexagonal head black	3C0853934		

## Clips

















Item No.	Item designation	Original No. 1	Original No. 2	image
5500-110-79	Interior trim clip pom / pa 66 black	7L6868243	95555524300	
5500-110-75	Expanding nut ø 5.0 mm pa 6 + pp gf 40 natural with rubber lip	N10621301	-	
5500-110-74	Expanding nut st. 4,8 mm pa 6 black	N90821401	-	
5500-110-98	Collar screw 6.0 x 18.5 mm delta seal sw gz	N90808201	-	
5500-110-83	Interior trim clip ø 8.1-8.5 mm pom fl with seal sw	2E1827649	A0119887678	
5500-110-71	Plastic expanding rivet ø 8.0 mm pa 66 black	N91141501	17111712963	
5500-110-70	Plastic expanding rivet ø 8.0 mm pa 6 black	3338676334FB	-	
5500-110-58	Repair blind rivet 4.8 x 6.5 incl. sealing washer 14.0 x 1	N90716103	-	
5500-110-50	Cover plug ø 10.5 - 10.7 mm pe ld black	1H086719901C	1H0867199	
5500-110-89	Pan head screw 5 x 16 zinc nickel black	N90974701	-	
5500-110-88	Self-tapping screw with washer black	N10309101	7703016405	
5500-110-60	Clamping washer for t-bolt ø 5.0 mm delta protekt silver	N90796502	-	
5501-123-301	Decorative trim clamp neutral with red ring	113853585C		
5501-107-123	Decorative trim clip Pom neutral	3C0853585		
5501-457-90	Screw cap mount Pom black	4A0805163		
5501-458-00	Screw cap mount Si	4A0805960		



## Clips

Item No.	Item designation	Original No. 1	Original No. 2	image
5501-461-40	Screw cap mount Si	8D0805960		
5501-445-90	Plastic expanding rivet Ø 8.0 Mm Pom 550 black	8L0807300		
5500-113-65	Sheet nut St. 4.8 Mm Vz FI Pass	N0154452		
5500-000-430	Cardboard clamp Vz FI	N0143893	N143893	
5500-113-62	Sheet nut St. 4.2 Mm Vz FI Pass	N0154292	1507925	
5500-032-010	Sheet nut M6 Mkb 2.2 Si Gz	N90168602		
5500-156-1	Sheet nut St. 4.2 Mm Vz FI Pass	211837223	N0154301	
5501-001-90	Sheet nut St. 6.3 Mm Vz FI Pass	N0154322		
5501-105-080	Sheet screw 4.8 x 16 with pressured washer Vz Cr-3*	N90775001		
5500-201-341	Cable tie 210 X 4.8 Mm with foot Ø 6.5 Mm black	N90666101		
5500-523-14	Plastic expanding rivet Ø 5.0 - 5.5 Mm Pa 6 black	N10259301	1L0853934	
5501-103-035	Plastic expanding rivet Ø 5.5 - 6.4 Mm Pa 661 black	N10219501	N10219502	
5500-110-34	Drive rivet Ø 6.2 Mm Pa 6 / Pom black	N8868307 8		
5500-110-32	Drive rivet Ø 6.2 Mm Pa 6 / Pom black	7L6868307	8Z0857784	
5500-127-10	Plastic expanding rivet Ø 5.9 - 7.1 Mm Pa 6 black	N0385012		
5500-000-000	Quicky for T-bolts Ø 5.0 Mm Geo Plus	N90335004	N90335006	

## Clips

Item No.	Item designation	Original No. 1	Original No. 2	image
5501-107-101	Clamping washer for T-bolts Ø 5.0 mm Geomet 321 silver	N90796501		
6129-65-20	Combi screw 7976 6.3X19 washer 1.6 x 18 Vz FI*	311821143	91403106203	
5501-457-60	Screw cap Pa black	4A0805121A		
5501-457-80	Screw cap Pa black	4A0805121C		
5501-105-064	Plastic expanding rivet Ø 6.0 - 6.2 Mm Pa 66 black	N90359101		
5501-659-50	Quick-lock screw 7.0 X 18.0 Delta Protekt	8D0805121		
5500-110-16	Plastic expanding rivet Ø 7.8 - 8.8 Mm Pa 66 black	N10583501		
5500-130-11	Plastic expanding rivet Ø 7.9 - 8.5 Mm Pa 66 black	16186729901C	N038549101C	
5501-402-50	Plastic expanding rivet Ø 7.0 - 7.2 Mm Pa 66 black	171885767	A0019944145	
5501-461-30	Screw fastener metal 7.0 x 21.0 black	8D0805121B		
5501-447-50	Plastic expanding rivet Ø 8.0 Mm Pa 66 black	4D0807300B		
5500-145-84	Plastic expanding rivet Ø 8.0 - 8.2 Mm Pa 12 black	N90229301		
5501-104-038	Plastic expanding rivet Ø 8.0 - 8.6 Mm Pa 12 black	N10032301		
5501-103-068	Plastic expanding rivet Ø 8.0 - 8.6 Mm Pa 661 black*	N10552001		
5500-110-14	Removable plastic expanding rivet Pa 66 black	8E0825267		
5500-117-75	Grommet E / Ba black	113857219A		

## Clips



Item No.	Item designation	Original No. 1	Original No. 2	image
5501-464-20	Interior trim clip Ø 10.0 X 10.2 Mm Pom black	8E0868243		
5501-107-121	Door gasket clip Pa 66 yellow	1Z0837732A		
5500-147-20	Door gasket clip Pa 665 black	251823717		
5501-101-205	Interior trim clip Pom black with grommet Pe-Ld neutral		1H0837719	
5501-442-50	Fir tree clip Pa 66 black	1H0819055B01C		
5501-301-70	Fir tree clip Ø 6.0 Mm Pa 66 black	82386320301C		
5500-129-54	Interior trim clip Ø 7.8 - 8.0 Mm Pa 66 black	823867299		
5500-917-0	Cover plug Ø 7.8 X 8.0 Mm Pom black	80186729901C	801867299041	
5501-424-90	Interior trim clip Ø 7.9 Mm Pa 66 neutral	171867299B		
5501-104-046	Interior trim clip Ø 7.9 - 8.0 Mm Pom neutral	4D0867299A		
5501-464-00	Interior trim clip Pom / Pa 66 black	6Q0868243		
5500-405-0	Interior trim clip Ø 8.1 - 8.5 Mm Pom neutral	2E0867059	A0069884378	
5501-445-30	Interior trim clip Ø 8.0 - 8.2 Mm Pom neutral	6X0867300A		
5501-337-30	Interior trim clip Ø 8.0 - 8.2 Mm Pom yellow	7M0867299K		
5501-105-601	Fir tree clip Ø 8.0 - 8.5 Mm Pe Ld black	N90201601	1079129	
5500-110-25	Interior trim clip Pom neutral	8E9867299		



## Clips

Item No.	Item designation	Original No. 1	Original No. 2	image
5501-449-60	Expanding nut Pa 66 black*	N90833801		
5501-060-90	Expanding nut St. 4.2 Mm Pa 661 neutral	441035555		
5500-879-32	Expanding nut St. 4.8 Mm Pa 6 Gf 30 black	867809966		
5501-107-114	Expanding nut St. 4.8 Mm Pa 6 neutral with rubber lip black	N10516801		
5500-897-33	Expanding nut St. 4.8 Mm Pa 6 Gf 30 black	811807577F		
5501-101-001	Expanding nut St. 4.8 Mm Pa 6 Gf 30 black	811807577C		
5501-101-229	Expanding nut St. 4.8 Mm Pa 6 black	357827998		
5501-447-30	Cover plug Ø 7.9 - 8.1 Mm Pe black	N90533301		
5501-432-70	Blind rivet 4.0 X 14.0 alu / steel black	N90634901		
5500-115-22	Sheet nut St. 4.8 Mm Vz FI Pass			
5501-001-30	Sheet nut St. 4.8 Mm Vz FI Pass	6131890118	A0009947245	
5500-113-69	Sheet nut St. 6.5 Mm Vz FI Pass	803821117		
5501-055-10	Sheet nut St. 4.8 Mm stainless steel (1.4301)	N10194101		
5501-067-90	Sheet nut St. M4 self-tapping Mkb 2.0 Si	N90419002		
5501-441-00	Sheet nut St. 6.3 Mm Mkb 2.2 Si Gz	N0154491	N0154492	
5500-238-3	Cable tie 140 X 4.5 Mm with foot Pa 66 black	N90205501		



Clips				
Item No.	Item designation	Original No. 1	Original No. 2	image
5501-447-70	Door frame clip Ø 4.0 Mm Pom white	171837199		
5501-107-130	Plastic nut 5.0 Pa 66 Gf 30 black	WHT003207		
5500-937-7	Plastic expanding rivet Ø 8.0 - 8.2 Mm Pa 66 dark grey	N0385501		
5501-107-108	Plastic expanding rivet Pa 66 black	8L3837199B		
5501-101-228	Expanding nut St. 4.2 Mm Pa 66 beige	165827592		
5501-449-30	Expanding nut St. 5.5 Mm Pa 66 black	441807300B		
5501-440-50	Grommet Tpv green	1H0853586		
5501-101-105	Interior trim clip Pom black	3B0868243		
5501-101-211	Interior trim clip Ø 8.0 Mm Pom / Pa 66 - brown / neutral	1H0868243B	1H0868243	
5501-446-90	Interior trim clip Ø 8.0 - 8.2 Mm Pom neutral	6X0868243A		
5501-464-40	Interior trim clip Pom black with seal*	5X0867299		
5501-117-74	Decorative trim clamp zinc-plated*	113853585B		
5501-101-206	Decorative trim clamp neutral Golf Iii (short)	1H0853585		
5501-101-003	Roof decorative trim clamp Pom neutral	191853733A	6U0853733	
5501-101-207	Decorative trim clip Pom neutral	1H0853585A		
5501-101-208	Decorative trim clip Pom neutral	1H0853733B		

Clips				
Item No.	Item designation	Original No. 1	Original No. 2	image
5501-063-10	Self-tapping nut M4 Vz FI Pass	N0386021		
5501-101-237	Square drive rivet 8.5 X 8.5 Mm with cap Pa 6 black	1H0819055C01C		
5501-400-70	Door gasket clip Pa 6 white	133823717		
5501-448-60	Door gasket clip Pa 66 grey	3B0839723		
5501-445-60	Percussion rivet Ø 7.4 - 7.6 Mm Pom / Ppe+Pa black	4D0807300		
5501-010-2	Weldable nut M8 blank	N0114071		
5500-114-70	Sheet nut St. 4.8 Mm Vz FI Pass matt	N0154581		
5501-143-00	Plastic expanding rivet Ø 3.5 X 3.7 Mm Pom black	113857117B		

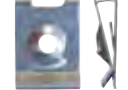
Clips				
Item No.	Item designation	Original No. 1	Original No. 2	image
5500-110-91	Blind rivet plastic 6.3 x 28.9 mm pa / pom black	07149140786	0940910312	
6464-012-244	Sealing ring aluminium 12x21x1,7	9043012031		
5500-110-90	Blind rivet plastic 6.3 x 25.2 mm pa / pom black	07142151750	-	
5500-113-47	Sheet metal nut 3.9mm			

## Clips





Item No.	Item designation	Original No. 1	Original No. 2	image
5500-110-82	Inner trim clip ø 7.8-8.0 mm pom fl with gasket	51418224768	W702985S300	
5500-110-80	Inner lining clip ø 7,8-8,0 mm pom fl with seal sw	07147145753	-	
5500-110-71	Plastic expanding rivet ø 8.0 mm pa 66 black	N91141501	17111712963	
5500-110-63	Plastic nut 5.0 partition wall wheel installation pom black	51711958025	A2019900050	
5501-105-069	Sheet metal nut 3.9 mm			
5501-104-039	Screw rivet for partition wall, wheel installation		126 990 03 92	
5500-110-95	Screw rivet black	07130702966	94530623	
5500-110-77	Grommet pe-ld colourless with metal clip vz	07149158194	-	
5500-000-430	Cardboard clamp Vz FI	N0143893	N143893	
5500-032-010	Sheet nut M6 Mkb 2.2 Si Gz	N90168602		
5500-032-040	Sheet nut M8 Vz FI Pass	6103426		
5500-053-7	Sheet nut St. 4.8 Mm Vz FI Pass	1450293	207266	
5500-110-130	Cover plug black	51489119216		
5500-110-131	Plastic expanding rivet black	51127004445		
5500-110-16	Plastic expanding rivet Ø 7.8 - 8.8 Mm Pa 66 black	N10583501		
5500-113-62	Sheet nut St. 4.2 Mm Vz FI Pass	N0154292	1507925	





## Clips

Item No.	Item designation	Original No. 1	Original No. 2	image
5500-113-65	Sheet nut St. 4.8 Mm Vz FI Pass	N0154452		
5500-113-69	Sheet nut St. 6.5 Mm Vz FI Pass	803821117		
5500-114-04	Sheet nut St. 6.3 Mm Vz FI Pass	6031840	6738766	
5500-114-27	Sheet nut St. 6.3 Mm Vz FI Pass	1470998	207217563	
5500-114-70	Sheet nut St. 4.8 Mm Vz FI Pass matt	N0154581		
5500-115-22	Sheet nut St. 4.8 Mm Vz FI Pass			
5500-115-77	Sheet nut St. 5.5 Mm Vz FI Pass	7129925720	2072077	
5500-116-67	Sheet nut St. 4.2 Mm Vz FI Pass	A0009942345		
5500-117-61	Sheet nut St. 8.0 Mm Vz FI Pass	7129925749		
5500-130-11	Plastic expanding rivet Ø 7.9 - 8.5 Mm Pa 66 black	16186729901C	N038549101C	
5500-201-404	Plastic expanding rivet Ø 8.0 - 8.2 Mm Pa 6 black	A2019900292	A2019900292/9051	
5500-411	Blind rivet plastic 5.0 X 12.0 Mm Pa 66 black			
5500-523-14	Plastic expanding rivet Ø 5.0 - 5.5 Mm Pa 6 black	N10259301	1L0853934	
5500-910-1	Expanding nut Pa 6 neutral	51135680113		
5500-911-8	Interior trim clip Ø 9.0 - 9.5 Mm Abs black	435109		
5501-103-022	Washer nut M6 Vz	N910104006000		



Clips				
Item No.	Item designation	Original No. 1	Original No. 2	image
5501-104-051	Plastic nut 5.0 Pa 6 black	A0039900251		
5501-105-014	Grommet Pa 66 neutral	51131934160		
5501-105-041	Plastic expanding rivet for washer cover E34 Pom black	51711928946		
5501-105-063	Plastic expanding rivet Ø 6.0 - 6.2 Mm Pa 66 black	51111944537		
5501-105-064	Plastic expanding rivet Ø 6.0 - 6.2 Mm Pa 66 black	N90359101		
5501-105-073	Sheet nut St. 4.8 Mm Mkb 2.1 Si	7129901656	7129925734	
5501-105-079	Washer nut M8 Vz blue Cr-3	51111835625	51117070183	
5501-105-601	Fir tree clip Ø 8.0 - 8.5 Mm Pe Ld black	N90201601	1079129	
5501-107-102	Interior trim clip Ø 7.9 - 8.0 Mm Pom green	51411870718		
5501-107-103	Interior trim clip Ø 7.9 - 8.0 Mm Pom neutral	51411973500		
5501-107-124	Interior trim clip Ø 8.3 - 8.5 Mm Pom yellow	7131503417		
5501-107-127	Interior trim clip Ø 8.2 Mm Pom blue	51139804996		
5501-523-20	Plastic expanding rivet Ø 6.0 - 6.2 Mm Pa 66 black	51118174185		
5501-529-80	Blind rivet plastic 5.8 X 19.0 Mm Pa / Pom black*	51717002953	51777171004	
5501-530-60	Interior trim clip Ø 7.9 - 8.0 Mm Pom yellow	51418172050		
6129-48-16	Combi screw 7976 4.8X16 washer 1.5 x 15 Vz Fl*	7119916946	7119901294	

















Clips				
Item No.	Item designation	Original No. 1	Original No. 2	image
6129-48-19	Combi screw 7976 4.8X19 washer 1.5 x 15 Vz Fl*	7119916949		
6134-039-13	Collar screw 3.9 X 13 Vz3*	51.131.823.634		
6365-8	Flange nut self-tapping M8 Sw 12 Vk*	A1201420072		
6366-2	Slotted nut 14441 M8 X 1.25 Sw 12 Vk 6My*	A0009903250		

Clips				
Item No.	Item designation	Original No. 1	Original No. 2	image
5500-110-86	Interior trim clip ø 8.0 mm pom black	856534	-	
5500-110-84	Inner lining clip ø 8.2 mm pom fl with rubber lip sw	9345ZN	7703077476	
5500-110-147	Cage nut silver	7518GV		
5500-110-139	Plastic expanding rivet black	1622749580		
5500-110-65	Plastic expanding rivet ø 3.8 - 4.0 mm pom black	9023G0	A0009900492	
5500-110-87	Interior trim clip colourless	6822LL	MU000504	
5500-110-85	Interior trim clip ø 8,5 mm pa 6 colourless	6995X3	-	
5501-107-141	Door gasket clip Pa 662 black	7701044547		

## Clips





Item No.	Item designation	Original No. 1	Original No. 2	image
5500-110-31	Wheel bolt M12 X 1.5 x 20 Mm Sw 17 Geomet silver*	90942W2001		
5500-110-39	Plastic rivets without pin Ø 6.2 Mm Pom black	7703077078		
5500-110-18	Plastic expanding rivet Ø 6.0 Mm Pa 66 black	697346	6990C4	
5500-110-30	Screw M6 x 20 Sw 10 Dacromet Si	697404		
5500-110-7	Cover plug Ø 6.5 Mm Pa 6 black	699295	6999R2	
5500-110-1	Fir tree clip Ø 6.5 Mm Pa 66 black	7703077066		
5500-110-19	Plastic expanding rivet Ø 6.50 Mm Pa 661 black	699783	6997T2	
5500-110-9	Cover plug Ø 8.0 X 5.0 Mm Pom black	699786	9619769080	
5500-110-35	Screw cap Geomet silver	703016	9632676980	
5500-110-40	Screw cap mount Geomet Si	703018	9632677180	
5500-110-13	Plastic expanding rivet Ø 8.0 - 8.2 Mm Pa 6 black	A1239900292		
5501-107-140	Rod holder Ø 8.0 Mm Pom black	792831		
5500-110-28	Interior trim clip Ø 8.2 Mm Pa 66 neutral with seal	811024		
5501-107-110	Interior trim clip Ø 9.5 Mm Pom black	856535		
5500-110-27	Interior trim clip Ø 8.0 Mm Pom neutral	7701049270	71737918	
5501-107-113	Interior trim clip Ø 8.0 Mm neutral with seal black	856543	71728806	



## Clips

Item No.	Item designation	Original No. 1	Original No. 2	image
5501-107-112	Decorative trim clip Pom white	856548		
5501-107-139	Decorative trim clip Pom neutral	856558		
5500-939-5	Fir tree clip Ø 7.2 Mm Pa 66 dark grey	2338955	90431553	
5500-124-28	Plastic expanding rivet Ø 5.0 - 5.2 Mm Pa 122 black*	A0009900392	A0009902292	
5500-523-14	Plastic expanding rivet Ø 5.0 - 5.5 Mm Pa 6 black	N10259301	1L0853934	
5500-110-38	Cable clamp Ø 9.0 Mm Pa 6 grey	7703079070	14569680	
5500-001-191	Cable clamp Ø 17.0 Mm Pa 6 neutral	7703079072		
5500-110-15	Plastic expanding rivet Ø 4.0 - 4.2 Mm Pom 902 black	A0019902492		
5501-060-90	Expanding nut St. 4.2 Mm Pa 661 neutral	441035555		
5500-110-34	Drive rivet Ø 6.2 Mm Pa 6 / Pom black	8N8868307		
5500-110-33	Drive rivet Ø 6.2 Mm Pa 66 / Pom black	7703072327		
5500-110-16	Plastic expanding rivet Ø 7.8 - 8.8 Mm Pa 66 black	N10583501		
5500-110-12	Plastic expanding rivet Ø 8.0 - 8.2 Mm Pa 6 black	99950749740		
5500-110-20	Plastic expanding rivet Ø 8.05 - 8.30 Mm Pa 66 black	9648975680	856553	
5500-110-32	Drive rivet Ø 6.2 Mm Pa 6 / Pom black	7L6868307	8Z0857784	
5501-132-004	Plastic expanding rivet Ø 8.0 Mm Pom / Pa Gf black*	9046708185		



















Clips				
Item No.	Item designation	Original No. 1	Original No. 2	image
5501-130-055	Plastic expanding rivet Ø 7.0 Mm Pbt / Pom black*	9046707166		
5500-110-25	Interior trim clip Pom neutral	8E9867299		
5500-110-26	Interior trim clip Ø 8.2 Mm Pom FI with rubber lip Sw	7703077469	9654280780	
5501-107-127	Interior trim clip Ø 8.2 Mm Pom blue	51139804996		
5500-110-8	Cover plug Ø 4.7 Mm Pa 66 black	6992K8	6999A3	
5500-110-2	Cover plug Ø 6.7 Mm Pom black	7703077068		
5500-110-37	Percussion rivet Ø 8.1 - 8.3 Mm Pa 66 black	7013J0	8211WV	
5501-107-105	Cover plug Ø 6.3 - 6.7 Mm Pa 66 black	A0009881128		
5500-110-4	Cover plug Ø 10.2 Mm Pe black	7703077225		
5500-110-17	Plastic expanding rivet Ø 4.55 X 5.15 Mm Pom black	A0019901392		
5500-110-6	Cover plug for 5.0 threaded bolts Pp black	6142789		













Clips				
Item No.	Item designation	Original No. 1	Original No. 2	image
5500-110-95	Screw rivet black	07130702966	94530623	
5500-110-69	Plastic expanding rivet ø 3.25 - 6.75 mm pa 66 black	11589289	4855809	
5501-103-015	Plastic expanding rivet Ø 8.0 Mm Pa 6 black	90138810		
5501-107-105	Cover plug Ø 6.3 - 6.7 Mm Pa 66 black	A0009881128		
5501-103-011	Pom interior trim clip white	2345957	90321122	
5501-103-073	Door frame clip black	134786	90044397	

Clips				
Item No.	Item designation	Original No. 1	Original No. 2	image
6464-012-244	Sealing ring aluminium 12x21x1,7	9043012031		
5500-774-7	Expanding nut Pa 6 black*	9018906013		

## Clips

Item No.	Item designation	Original No. 1	Original No. 2	image
5500-110-100	ivet à impact noir	71741887	0940908327000	
5500-110-51	Clip de sapin ø 9,0 mm pa 6 noir	14592187		
5500-110-52	Bouchon de protection ø 8.0 - 9.0 mm pa 6 gris foncé	1301019650	130101965	
5500-110-105	Clip de sapin Ø 8,0 mm PA 6 noir	14591487		
5500-110-116	Bouchon de protection noir	1301019808		
5500-110-115	Yellow interior trim clip	14191280		
5500-110-110	Écrou en tôle M6 VZ FL PASS	7740882	60808479	
5500-110-76	Écrou à expansion st. 4,8 mm pa 6 incolore avec joint	46408953	-	
5500-110-73	Rivet expansible en plastique ø 6,3 - 6,7 mm pa 6 noir	5988006	-	
5500-110-54	Rivet aveugle 6,4 x 11,0 aluminium / acier	51750705	A0049902897	
5501-106-095	Metal clamp holder for window crank oiled	136511	6235332	
5501-107-118	Fir tree clip Ø 6.5 Mm Pa 66 black	4274360		
5500-117-51	Grommet Pa 6 red	A0009881581		
5501-107-115	Plastic expanding rivet Ø 8.0 Mm Pa 6 black	7600779		
5500-032-010	Sheet nut M6 Mkb 2.2 Si Gz	N90168602		
5500-110-38	Cable clamp Ø 9.0 Mm Pa 6 grey	7703079070	14569680	

## Clips

Item No.	Item designation	Original No. 1	Original No. 2	image
5501-107-117	Fir tree clip Ø 6.5 Mm Pa 6 black	14591687		
5501-107-130	Plastic nut 5.0 Pa 66 Gf 30 black	WHT003207		
5501-103-015	Plastic expanding rivet Ø 8.0 Mm Pa 6 black	90138810		
5501-107-113	Interior trim clip Ø 8.0 Mm neutral with seal black	856543	71728806	
5500-110-27	Interior trim clip Ø 8.0 Mm Pom neutral	7701049270	71737918	
5501-129-003	Percussion rivet Pom black*	9046707164		
5500-337-20	Interior trim clip Ø 8.0 - 8.4 Mm Pom black / neutral	1020732		
5501-912-50	Decorative trim clip grey	93160023	4409693	
5501-103-035	Plastic expanding rivet Ø 5.5 - 6.4 Mm Pa 661 black	N10219501	N10219502	
5501-107-116	Fir tree clip Ø 6.5 Mm Pa 6 grey	712113631		
5500-110-8	Cover plug Ø 4.7 Mm Pa 66 black	6992K8	6999A3	
5500-110-19	Plastic expanding rivet Ø 6.50 Mm Pa 661 black	699783	6997T2	
5500-110-26	Interior trim clip Ø 8.2 Mm Pom FI with rubber lip Sw	7703077469	9654280780	



## Clips

Item No.	Item designation	Original No. 1	Original No. 2	image
6243-30-3	Sealing ring Ford made of plastic 30 x 3.0 mm NBR	sličan 1871600		
5500-032-170	Expansion nut black			
5500-110-132	Plastic expanding rivet black	4902755		
5500-110-118	Plastic expanding rivet, black	11589295	W712665S300	
5500-110-117	Cover plug beige	XW7Z6302354AA6		
5500-110-146	Cover plug black	6800422		
5500-110-145	Plastic expanding rivet black	4605824		
5500-110-140	Plastic expanding rivet black	1783872		
6243-30-2	Ford plastic oil drain plug incl. Sealing ring			
5500-113-62	Sheet nut St. 4.2 Mm Vz FI Pass	N0154292	1507925	
5500-113-69	Sheet nut St. 6.5 Mm Vz FI Pass	803821117		
6129-65-20	Combi screw 7976 6.3X19 washer 1.6 x 18 Vz FI*	311821143	91403106203	
5500-113-46	Sheet nut St. 3.9 Mm Vz FI Pass	237929		
5500-911-8	Interior trim clip Ø 9.0 - 9.5 Mm Abs black	435109		
5500-000-430	Cardboard clamp Vz FI	N0143893	N143893	
5500-010-060	Door gasket clip Pa 665 neutral	704948		





## Clips

Item No.	Item designation	Original No. 1	Original No. 2	image
5501-337-30	Interior trim clip Ø 8.0 - 8.2 Mm Pom yellow	7M0867299K		
5501-103-035	Plastic expanding rivet Ø 5.5 - 6.4 Mm Pa 661 black	N10219501	N10219502	
5500-337-20	Interior trim clip Ø 8.0 - 8.4 Mm Pom black / neutral	1020732		
5500-110-14	Removable plastic expanding rivet Pa 66 black	8E0825267		
5501-101-205	Interior trim clip Pom black with grommet Pe-Ld neutral	1H0837719		
5501-105-601	Fir tree clip Ø 8.0 - 8.5 Mm Pe Ld black	N90201601	1079129	
5500-336-90	Fastening for pollen filter cover black / neutral	1106903	W703475S300	
5500-033-310	Sheet nut St. 4.2 Mm Vz FI Pass	1138971	W707715S309	
5501-107-133	Interior trim clip Ø 6.0 Mm Pom neutral	1208973		
5501-701-00	Expanding nut Pa 66 neutral	1416795		
6365-61	Flange nut M8 Sw 13 H 8 self-tapping Vk*	1448187		
5500-053-7	Sheet nut St. 4.8 Mm Vz FI Pass	1450293	207266	
5500-156-1	Sheet nut St. 4.2 Mm Vz FI Pass	211837223	N0154301	
5500-114-27	Sheet nut St. 6.3 Mm Vz FI Pass	1470998	207217563	
5500-307-71	Spring cotter pin A2*	1473931		
5500-121-9	Sheet nut St. 3.5 Mm Vz FI Pass	1474663	311821161	





## Clips

Item No.	Item designation	Original No. 1	Original No. 2	image
5500-030-540	Cover plug Ø 8.2 - 8.4 Mm Pa 66 black	1480335		
5501-301-70	Fir tree clip Ø 6.0 Mm Pa 66 black	82386320301C		
5501-107-131	Interior trim clip Ø 6.0 Mm Pom neutral	1552662	W709010S300	
5501-107-130	Plastic nut 5.0 Pa 66 Gf 30 black	WHT003207		
5500-940-5	Fir tree clip Ø 7.0 - 7.4 Mm Pa 66 black	1629082	1618742	
5500-145-45	Cover plug Ø 8.40 X 8.62 Mm Pom black	1629279	6725950	
5500-033-590	Expanding nut St. 4.8 Mm Pa 6 white	1659672		
5500-053-6	Sheet nut St. 4.2 Mm Vz FI Pass	1716235		
5500-114-04	Sheet nut St. 6.3 Mm Vz FI Pass	6031840	6738766	
5500-031-190	Fir tree quick fastener Pom black	6049625		
5500-137-361	Cover plug Ø 7.0 Mm Pho Imp	6071353		
5500-032-050	Sheet nut M8 self-tapping Vz FI Pass	6089805		
5500-032-040	Sheet nut M8 Vz FI Pass	6103426		
5500-033-340	Square drive rivet 7.1 X 11.0 Mm Pa 66 black	6114021		
5500-405-0	Interior trim clip Ø 8.1 - 8.5 Mm Pom neutral	2E0867059	A0069884378	
5500-130-11	Plastic expanding rivet Ø 7.9 - 8.5 Mm Pa 66 black	16186729901C	N038549101C	

## Clips















Item No.	Item designation	Original No. 1	Original No. 2	image
5500-110-6	Cover plug for 5.0 threaded bolts Pp black	6142789		
5501-107-129	Fir tree clip Ø 8.0 X 8.2 Mm Pom black	6560532	W700185S300	
6134-048-16	Collar screw 4.8 X 16 Vz3*	6707417	W700426S303	2 
5500-000-000	Quicky for T-bolts Ø 5.0 Mm Geo Plus	N90335004	N90335006	
5500-937-7	Plastic expanding rivet Ø 8.0 - 8.2 Mm Pa 66 dark grey	N0385501		
5500-411	Blind rivet plastic 5.0 X 12.0 Mm Pa 66 black			
5500-001-191	Cable clamp Ø 17.0 Mm Pa 6 neutral	7703079072		
5500-032-000	Sheet nut M5 Mkb 2.2 Sw	E824115S74		
5500-032-290	Sheet nut St. 4.8 Mm self-tapping Mkb 2.0 Si	E824123S71		

## Clips



Item No.	Item designation	Original No. 1	Original No. 2	image
5500-110-96	Black screw rivet	90683SA5003	-	
5500-110-99	Door seal clip colourless	91530ST5003	-	
5500-110-53	Fir tree clip ø 7.9 - 8.1 mm pa 6 black	91606SE3003	6J0853379	
5500-110-56	Blind rivet 6.0 x 21.3 steel / steel with grommet black	1071415	697202	





## Clips

Item No.	Item designation	Original No. 1	Original No. 2	image
5500-110-57	Blind rivet 4.8 x 20.5 aluminium / aluminium	7000412	11589289	
5500-110-92	Screw rivet ø 6,2 mm pa 6 black	1007932	-	
5500-110-102	Screw rivet ø 7.9 - 8.1 mm pom black	4327144	BC1D56145	
5500-110-78	Interior trim clip ø 5.0 mm pom black	1042065	-	
5500-110-95	Screw rivet black	07130702966	94530623	
5500-110-133	Interior trim clip gray	91560SLJJ01		
5500-771-0	Expanding nut neutral*	9018904014		
5500-785-082	Door gasket clip Pa 6 neutral*	90664671003		
5500-785-021	Plastic rivet without pin black*	90672671003		
5501-129-003	Percussion rivet Pom black*	9046707164		
5500-785-045	Expanding nut M4 Pe neutral with foam ring*	9751922000		
5500-785-087	Drive rivet Pa 66 black*	9046708145		
5500-785-083	Drive rivet Ø 6.0 Mm Pa 6 black*	5578552020		
5501-129-013	Percussion rivet Pom black*	91501S04003	91512S04003	
5501-129-001	Plastic expanding rivet Ø 10.0 X 10.2 Mm Pp / Pom black*	91503SZ3003		



## Clips

Item No.	Item designation	Original No. 1	Original No. 2	image
5500-110-121	Sheet metal nut black	1335706017B		
5500-785-045	Expanding nut M4 Pe neutral with foam ring*	9751922000		







## Clips

Item No.	Item designation	Original No. 1	Original No. 2	image
6464-114-22	Aluminium ring simil. Din 7603A, 14.0 X 22.0 X 2.0	2.151.323.000	K995641400	
5500-785-045	Expanding nut M4 Pe neutral with foam ring*	9751922000		
5500-777-3	Drive rivet Ø 6.2 - 7.0 Mm Pa 6 black*	9046706017		







## Clips

Item No.	Item designation	Original No. 1	Original No. 2	image
5500-110-134	Interior trim clip black	DYC500030		
5500-110-23	Interior trim clip Ø 8.2 Mm Pom neutral / yellow	4414720	93176656	

## Clips

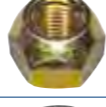
Item No.	Item designation	Original No. 1	Original No. 2	image
5500-110-102	Screw rivet ø 7.9 - 8.1 mm pom black	4327144	BC1D56145	
6362-112-15	Wheel nut M12 x 1.5 Sw 21 Vzg-3*	30.873.148		
5500-789-051	Plastic rivets without pin Ø 3.2 - 3.6 Mm Pa 6 black*			
5500-788-028	Plastic rivets without pin Ø 6.0 Mm Pa 6 black*	155300291		
5501-131-004	Percussion rivet black*	B46768AC3		
5501-131-002	Drive rivet black*	NA0156145		

## Clips

















Item No.	Item designation	Original No. 1	Original No. 2	image
5500-110-87	Interior trim clip colourless	6822LL	MU000504	
5500-405-0	Interior trim clip Ø 8.1 - 8.5 Mm Pom neutral	2E0867059	A0069884378	
5500-201-404	Plastic expanding rivet Ø 8.0 - 8.2 Mm Pa 6 black	A2019900292	A2019900292/9051	
6362-112-15	Wheel nut M12 x 1.5 Sw 21 Vzg-3*	30.873.148		
5500-777-3	Drive rivet Ø 6.2 - 7.0 Mm Pa 6 black*	9046706017		
5501-130-010	Percussion rivet Pom / Ppo black*	9046707041		
5501-132-003	Plastic expanding rivet Ø 8.0 - 8.2 Mm Pom / Pp Gf 20 black*	155309321		

## Clips

Item No.	Item designation	Original No. 1	Original No. 2	image
5500-110-59	Sheet metal nut M5 vz fl pass	A0019907291	-	
5500-110-54	Rivet aveugle 6,4 x 11,0 aluminium / acier	51750705	A0049902897	
5500-110-63	Plastic nut 5.0 partition wall wheel installation pom black	51711958025	A2019900050	
5500-110-65	Plastic expanding rivet ø 3.8 - 4.0 mm pom black	9023G0	A0009900492	
5500-110-67	Plastic expanding rivet pa 66 black	A1249900492	-	
5500-110-106	U-clamp 1.5 - 2.0 mm vz FL PASS	A0019887678		
5500-110-122	Cover plug black	A0039981350		
5500-110-66	Plastic expanding rivet ø 6.0 - 6.2 mm pom black	A0009904592	1268176	
5500-110-109	Sheet metal nut M6 VZ FL PASS	A0039941745		
5501-104-035	Grommet for trim clip white			
5501-104-039	Screw rivet for partition wall, wheel installation		126 990 03 92	
6464-22-32	Sealing ring Smart CU ring	0189974445		
5500-110-83	Interior trim clip ø 8.1-8.5 mm pom fl with seal sw	2E1827649	A0119887678	
5500-110-55	Blind rivet 4.0 x 18.8 alu / alu	A0039909497	-	
5500-115-22	Sheet nut St. 4.8 Mm Vz Fl Pass			
5500-937-7	Plastic expanding rivet	N0385501		



## Clips

Item No.	Item designation	Original No. 1	Original No. 2	image
5501-105-601	Fir tree clip Ø 8.0 - 8.5 Mm Pe Ld black	N90201601	1079129	
5501-107-105	Cover plug Ø 6.3 - 6.7 Mm Pa 66 black	A0009881128		
5500-117-51	Grommet Pa 6 red	A0009881581		
5500-112-89	Cable clamp 2 X Ø 4.0 Mm Vz FI Pass	A0009881778		
5501-060-90	Expanding nut St. 4.2 Mm Pa 661 neutral	441035555		
5500-124-28	Plastic expanding rivet Ø 5.0 - 5.2 Mm Pa 122 black*	A0009900392	A0009902292	
5500-130-11	Plastic expanding rivet Ø 7.9 - 8.5 Mm Pa 66 black	16186729901C	N038549101C	
6366-3	Slotted nut 14441 M10 X 1.5 Sw 14 Vk 6My*	A0009903150		
6366-2	Slotted nut 14441 M8 X 1.25 Sw 12 Vk 6My*	A0009903250		
5500-523-14	Plastic expanding rivet Ø 5.0 - 5.5 Mm Pa 6 black	N10259301	1L0853934	
5501-104-038	Plastic expanding rivet Ø 8.0 - 8.6 Mm Pa 12 black	N10032301		
5500-941-2	Drive rivet Ø 4.8 - 5.2 Mm Pa 66 black	A0009904092	A1249900592/9051	
5500-290-1	Square drive rivet 5.0 X 5.0 Mm Pa 66 black	A0009904492		
5501-107-104	Drive rivet Ø 6.2 Mm Pa 66 black	A0009904692		
5501-105-064	Plastic expanding rivet Ø 6.0 - 6.2 Mm Pa 66 black	N90359101		
5501-103-035	Plastic expanding rivet Ø 5.5 - 6.4 Mm Pa 661 black	N10219501	N10219502	

## Clips

Item No.	Item designation	Original No. 1	Original No. 2	image
5501-104-404	Interior trim clip Ø 8.0 - 8.2 Mm Pom grey	A0009905792		
5501-447-50	Plastic expanding rivet Ø 8.0 Mm Pa 66 black	4D0807300B		
5500-939-6	Fir tree clip Ø 7.0 - 7.2 Mm Pa 66 black	A0009912895		
5500-110-32	Drive rivet Ø 6.2 Mm Pa 6 / Pom black	7L6868307	8Z0857784	
5500-113-65	Sheet nut St. 4.8 Mm Vz FI Pass	N0154452		
5500-114-04	Sheet nut St. 6.3 Mm Vz FI Pass	6031840	6738766	
5500-114-27	Sheet nut St. 6.3 Mm Vz FI Pass	1470998	207217563	
5500-114-70	Sheet nut St. 4.8 Mm Vz FI Pass matt	N0154581		
5500-116-67	Sheet nut St. 4.2 Mm Vz FI Pass	A0009942345		
5500-117-45	Sheet nut St. 4.2 Mm Vz FI Pass	A0009942545		
5500-113-46	Sheet nut St. 3.9 Mm Vz FI Pass	237929		
5500-113-69	Sheet nut St. 6.5 Mm Vz FI Pass	803821117		
5500-010-060	Door gasket clip Pa 665 neutral	704948		
5500-248-70	Interior trim clip upper section Pom white	A0019880981		
5501-104-031	Decorative trim clamp Pom neutral waxed	A0019884981		
5501-104-036	Grommet Pa 6 neutral	A0019887781		

## Clips

Item No.	Item designation	Original No. 1	Original No. 2	image
5501-445-60	Percussion rivet Ø 7.4 - 7.6 Mm Pom / Ppe+Pa black	4D0807300		
5500-110-17	Plastic expanding rivet Ø 4.55 X 5.15 Mm Pom black	A0019901392		
5501-103-068	Plastic expanding rivet Ø 8.0 - 8.6 Mm Pa 661 black*	N10552001		
5500-110-15	Plastic expanding rivet Ø 4.0 - 4.2 Mm Pom 902 black	A0019902492		
5500-032-050	Sheet nut M8 self-tapping Vz FI Pass	6089805		
5501-402-50	Plastic expanding rivet Ø 7.0 - 7.2 Mm Pa 66 black	171885767	A0019944145	
5501-104-048	Car jack mount Db Tpe / Pp Gf black	A0019979586		
5501-107-130	Plastic nut 5.0 Pa 66 Gf 30 black	WHT003207		
5500-032-000	Sheet nut M5 Mkb 2.2 Sw	E824115S74		
5500-136-88	Interior trim clip Ø 7.5 - 7.7 Mm Pom neutral	A0039884178		
5501-447-70	Door frame clip Ø 4.0 Mm Pom white	171837199		
5501-104-051	Plastic nut 5.0 Pa 6 black	A0039900251		
5500-032-040	Sheet nut M8 Vz FI Pass	6103426		
5501-104-046	Interior trim clip Ø 7.9 - 8.0 Mm Pom neutral	4D0867299A		
5500-405-0	Interior trim clip Ø 8.1 - 8.5 Mm Pom neutral	2E0867059	A0069884378	
5500-124-63	Cable tie 160 X 9.0 Mm with rivet Pa 12 black	A1149970290	114 997 02 90	

## Clips

Item No.	Item designation	Original No. 1	Original No. 2	image
5500-124-65	Cable tie 120 X 9.0 Mm with rivet Pa 12 black	A1149970490		
6365-8	Flange nut self-tapping M8 Sw 12 Vk*	A1201420072		
5500-91-92	Plastic expanding rivet Ø 8.5 - 9.0 Mm Pa 6 dark grey	A1239900092		
5500-110-13	Plastic expanding rivet Ø 8.0 - 8.2 Mm Pa 6 black	A1239900292		
5500-132-19	Sheet nut St. 4.8 Mm Vz FI Pass	A1239940645	123 994 06 45	
5501-104-201	Decorative trim clamp Pa 66 black	A1249900792		
5500-113-62	Sheet nut St. 4.2 Mm Vz FI Pass	N0154292	1507925	
5500-201-404	Plastic expanding rivet Ø 8.0 - 8.2 Mm Pa 6 black	A2019900292	A2019900292/9051	
5501-104-054	Combi screw 7976 4.8X19 washer 2.0 x 26 Vzso*	A2019900536		
5500-606-14	Grommet Tpe-E neutral	A2019972281		
5501-107-134	Rain strip clamp Pom / Mkb Si	A2046900614		
5501-103-022	Washer nut M6 Vz	N910104006000		
6129-65-20	Combi screw 7976 6.3X19 washer 1.6 x 18 Vz FI*	311821143	91403106203	
6129-48-13	Combi screw 7976 4.8X13 washer 1.5 x 15 Vz FI*	N914032004214		



















## Clips

Item No.	Item designation	Original No. 1	Original No. 2	image
5500-110-124	Cover plug black	74849JD00A		
5500-110-125	Cover plug black	74849JD00B		
5500-110-123	Cover plug black	165802133		
5500-788-026	Expanding nut neutral*	9018906001		
5500-788-001	Plastic rivet without pin black*	155300172		
5500-788-028	Plastic rivets without pin Ø 6.0 Mm Pa 6 black*	155300291		
5501-132-005	Plastic expanding rivet Ø 10.0 Mm Pa 6 / Pom black*	57728AC090		
5501-132-003	Plastic expanding rivet Ø 8.0 - 8.2 Mm Pom / Pp Gf 20 black*	155309321		
5501-132-004	Plastic expanding rivet Ø 8.0 Mm Pom / Pa Gf black*	9046708185		
5500-110-36	Percussion rivet Ø 8.2 Mm Pom / Pa 66 Gf 13 black with slot	7703072360		
5501-132-002	Drive rivet black*	6385401A00	6384401A00	
5501-132-006	Drive rivet black*	6686001W01		

## Clips

Item No.	Item designation	Original No. 1	Original No. 2	image
5500-110-119	Plastic expanding rivet, black	11612035		
5500-110-135	Trim clip white	122920		
5500-110-95	Screw rivet black	07130702966	94530623	
5500-110-72	Plastic expanding rivet ø 5,9 - 6,1 mm pa 66 black	1406925	-	
5500-138-06	Sheet metal nut 3.5 - 4.8			
5500-110-120	Green interior trim clip	13252119		
5500-500-08	Upholstery clamp Vk	100490	6616858	
5501-103-073	Door frame clip black	134786	90044397	
5501-106-095	Metal clamp holder for window crank oiled	136511	6235332	
5500-010-060	Door gasket clip Pa 665 neutral	704948		
5501-101-205	Interior trim clip Pom black with grommet Pe-Ld neutral	1H0837719		
5500-124-28	Plastic expanding rivet Ø 5.0 - 5.2 Mm Pa 122 black*	A0009900392	A0009902292	
5501-103-007	Decorative trim clamp Pom neutral wheel case cover	174854	90481595	
5500-115-691	Sealing clip	176651		
6365-6	Flange nut M8 Sw 13 H 10 Vk*	854906	90080883	
6365-65	Flange nut M10 Sw 15 H 10 Vk*	854976	90108169	

## Clips

Item No.	Item designation	Original No. 1	Original No. 2	image
6129-63-16	Combi screw 7976 6.3X16 washer 1.6 x 22 Vz FI*	1.101.412	9.287.493	
5500-130-11	Plastic expanding rivet Ø 7.9 - 8.5 Mm Pa 66 black	16186729901C	N038549101C	
5501-104-038	Plastic expanding rivet Ø 8.0 - 8.6 Mm Pa 12 black	N10032301		
5501-103-068	Plastic expanding rivet Ø 8.0 - 8.6 Mm Pa 661 black*	N10552001		
5501-107-136	Prestole cage nut St. 6.3 Mm Mkb Si Gz	1110936	13154960	
5500-402-9	Fir tree clip Pe black	1162484	90040750	
5501-103-070	Rod holder Ø 7.0 Mm Pa 66 black	1180181	9114314	
5500-151-97	Hilo expanding nut 5.8 Mm Pa 6 neutral	1216957	90230960	
5501-103-004	Headlight mount Pom 130 neutral	1218601	90181010	
5501-103-019	Cable tie 119 X 9.7 Mm Pa 66 black*	1288885	90381846	
5501-103-078	Cable tie 115 X 4.8 Mm with foot P a 66 natural*	1288888	90461994	
5501-105-065	Plastic expanding rivet Ø 6.0 - 6.2 Mm Pa 66 black	1400804	90414659	
5501-103-017	Plastic expanding rivet Ø 6.0 - 6.2 Mm Pa 66 black	1400806	90508809	
5501-103-021	Sheet nut M5 self-tapping Vz FI Pass	1400906	90464538	
5501-107-100	Blind rivet 4.0 X 14.0 alu / steel	1406528	90589346	
5500-127-10	Plastic expanding rivet Ø 5.9 - 7.1 Mm Pa 6 black	N0385012		

## Clips



Item No.	Item designation	Original No. 1	Original No. 2	image
5501-103-015	Plastic expanding rivet Ø 8.0 Mm Pa 6 black	90138810		
6129-48-19	Combi screw 7976 4.8X19 washer 1.5 x 15 Vz FI*	7119916949		
6129-55-16	Combi screw 7976 5.5X16 washer 1.6 x 15 Vz FI*	2022107	11077982	
6129-63-25	Combi screw 7976 6.3X25 washer 1.6 x 18 Vz FI*	2022209	11074862	
6103-055-16	Number plate screw 7981 5.5 X 16 Mm Vz FI*	2038251		
6103-055-19	Number plate screw 7981 5.5 X 19 Mm Vz FI*	2.038.253	11.067.771	
6103-055-25	Number plate screw 7981 5.5 X 25 Mm Vz FI*	2.038.261	11.068.913	
5501-103-022	Washer nut M6 Vz	N910104006000		
5501-105-079	Washer nut M8 Vz blue Cr-3	51111835625	51117070183	
6365-61	Flange nut M8 Sw 13 H 8 self-tapping Vk*	1448187		
5500-113-21	Sheet nut St. 4.2 Mm Pho paint yellow	2072030	11074201	
5500-115-77	Sheet nut St. 5.5 Mm Vz FI Pass	7129925720	2072077	
5500-121-6	Blind rivet 4.8 X 11.0 steel / steel	2084170	11086102	
5501-105-601	Fir tree clip Ø 8.0 - 8.5 Mm Pe Ld black	N90201601	1079129	
5500-897-33	Expanding nut St. 4.8 Mm Pa 6 Gf 30 black	811807577F		
5500-127-09	Fir tree clip Pe black	2240861	90022049	



## Clips

Item No.	Item designation	Original No. 1	Original No. 2	image
5501-103-035	Plastic expanding rivet Ø 5.5 - 6.4 Mm Pa 661 black	N10219501	N10219502	
5501-103-071	Cover plug black	2336960	90431606	
5500-939-5	Fir tree clip Ø 7.2 Mm Pa 66 dark grey	2338955	90431553	
5500-939-6	Fir tree clip Ø 7.0 - 7.2 Mm Pa 66 black	A0009912895		
5501-103-011	Pom interior trim clip white	2345957	90321122	
5501-103-012	Interior trim clip Pom red	2345959	90457899	
5500-110-24	Interior trim clip Ø 8.2 Mm Pom neutral / grey	4414667	91169651	
5500-110-23	Interior trim clip Ø 8.2 Mm Pom neutral / yellow	4414720	93176656	
5500-110-14	Removable plastic expanding rivet Pa 66 black	8E0825267		
5501-107-105	Cover plug Ø 6.3 - 6.7 Mm Pa 66 black	A0009881128		
5501-103-069	Plastic expanding rivet dark grey	7336931	13105583	
6243-12-160	Locking screw M12 X 1.75 X 25 Sw 15 Vz*	4.948.795	9L8E6730AA	
5501-912-50	Decorative trim clip grey	93160023	4409693	
5500-114-27	Sheet nut St. 6.3 Mm Vz FI Pass	1470998	207217563	
5500-113-69	Sheet nut St. 6.5 Mm Vz FI Pass	803821117		
5500-307-71	Spring cotter pin A2*	1473931		



## Clips

Item No.	Item designation	Original No. 1	Original No. 2	image
6129-55-19	Combi screw 7976 5.5X19 washer 1.6 x 15 Vz FI*			
5500-117-61	Sheet nut St. 8.0 Mm Vz FI Pass	7129925749		









## Clips

Item No.	Item designation	Original No. 1	Original No. 2	image
5500-110-79	Interior trim clip pom / pa 66 black	7L6868243	95555524300	
5501-107-130	Plastic nut 5.0 Pa 66 Gf 30 black	WHT003207		
5500-110-12	Plastic expanding rivet Ø 8.0 - 8.2 Mm Pa 6 black	99950749740		
5501-107-103	Interior trim clip Ø 7.9 - 8.0 Mm Pom neutral	51411973500		
5500-110-34	Drive rivet Ø 6.2 Mm Pa 6 / Pom black	8N8868307		
5500-113-21	Sheet nut St. 4.2 Mm Pho paint yellow	2072030	11074201	
5500-121-9	Sheet nut St. 3.5 Mm Vz FI Pass	1474663	311821161	
5500-032-290	Sheet nut St. 4.8 Mm self-tapping Mkb 2.0 Si	E824123S71		
5500-113-62	Sheet nut St. 4.2 Mm Vz FI Pass	N0154292	1507925	
5500-156-1	Sheet nut St. 4.2 Mm Vz FI Pass	211837223	N0154301	
5500-114-70	Sheet nut St. 4.8 Mm Vz FI Pass matt	N0154581		

















## Clips

Item No.	Item designation	Original No. 1	Original No. 2	image
5500-130-11	Plastic expanding rivet Ø 7.9 - 8.5 Mm Pa 66 black	16186729901C	N038549101C	
5501-107-114	Expanding nut St. 4.8 Mm Pa 6 neutral with rubber lip black	N10516801		
6243-14-161	Locking screw M14 X 1.5 X 22 Sw 19 Zn Ni*	N90813201	N90813202	

## Clips

Item No.	Item designation	Original No. 1	Original No. 2	image
5500-110-62	Śruba kombinowana 5,0 x 25 mm t20 vzs	7703017090	-	
5500-110-88	Self-tapping screw with washer black	N10309101	7703016405	
5500-110-148	Screw black	7703602059		
5500-110-136	Klipsy wykończeniowe białe Renault	7701204862		
5501-107-141	Door gasket clip Pa 662 black	7701044547		
5500-110-27	Interior trim clip Ø 8.0 Mm Pom neutral	7701049270	71737918	
5500-110-14	Removable plastic expanding rivet Pa 66 black	8E0825267		
5500-110-25	Interior trim clip Pom neutral	8E9867299		
5500-110-10	Sheet nut M8 Vz FI Pass	7703046020		
5500-032-010	Sheet nut M6 Mkb 2.2 Si Gz	N90168602		

## Clips



Item No.	Item designation	Original No. 1	Original No. 2	image
5500-113-62	Sheet nut St. 4.2 Mm Vz FI Pass	N0154292	1507925	
5500-110-11	Plastic expanding rivet Ø 5.0 - 5.6 Mm Pa 12 black*	7703072144		
5500-127-10	Plastic expanding rivet Ø 5.9 - 7.1 Mm Pa 6 black	N0385012		
5500-124-28	Plastic expanding rivet Ø 5.0 - 5.2 Mm Pa 122 black*	A0009900392	A0009902292	
5500-110-15	Plastic expanding rivet Ø 4.0 - 4.2 Mm Pom 902 black	A0019902492		
5500-110-32	Drive rivet Ø 6.2 Mm Pa 6 / Pom black	7L6868307	8Z0857784	
5500-110-34	Drive rivet Ø 6.2 Mm Pa 6 / Pom black	8N8868307		
5500-110-33	Drive rivet Ø 6.2 Mm Pa 66 / Pom black	7703072327		
5500-110-36	Percussion rivet Ø 8.2 Mm Pom / P a 66 Gf 13 black with slot	7703072360		
5500-145-84	Plastic expanding rivet Ø 8.0 - 8.2 Mm Pa 12 black	N90229301		
5500-110-1	Fir tree clip Ø 6.5 Mm Pa 66 black	7703077066		
5500-110-2	Cover plug Ø 6.7 Mm Pom black	7703077068		
5500-110-39	Plastic rivets without pin Ø 6.2 Mm Pom black	7703077078		
5500-110-5	Cover plug Ø 8.2 Mm Pa 66 black	7703077153		
5500-110-4	Cover plug Ø 10.2 Mm Pe black	7703077225		
5500-110-23	Interior trim clip Ø 8.2 Mm Pom neutral / yellow	4414720	93176656	







## Clips

Item No.	Item designation	Original No. 1	Original No. 2	image
5501-912-50	Decorative trim clip grey	93160023	4409693	
5500-110-24	Interior trim clip Ø 8.2 Mm Pom neutral / grey	4414667	91169651	
5500-110-3	Fir tree clip Ø 10.2 - 10.7 Mm Pe Ld black	7703077435		
5500-110-26	Interior trim clip Ø 8.2 Mm Pom FI with rubber lip Sw	7703077469	9654280780	
5500-110-38	Cable clamp Ø 9.0 Mm Pa 6 grey	7703079070	14569680	
5500-001-191	Cable clamp Ø 17.0 Mm Pa 6 neutral	7703079072		
5500-110-6	Cover plug for 5.0 threaded bolts Pp black	6142789		
5500-110-21	Expanding nut St. 4.5 Mm Pa 66 natural	7703081184		
5501-107-142	Expanding nut St. 4.2 / 4.5 Mm Pa 66 Gf 30 FI with rubber lip	7703081232		
5500-110-22	Interior trim clip Pom neutral / green	8200702219	7701049008	
5500-523-14	Plastic expanding rivet Ø 5.0 - 5.5 Mm Pa 6 black	N10259301	1L0853934	

## Clips

Item No.	Item designation	Original No. 1	Original No. 2	image
5501-103-015	Plastic expanding rivet Ø 8.0 Mm Pa 6 black	90138810		
5500-130-11	Plastic expanding rivet Ø 7.9 - 8.5 Mm Pa 66 black	16186729901C	N038549101C	

## Clips

Item No.	Item designation	Original No. 1	Original No. 2	image
5500-110-103	Plastic expanding rivet ø 9.9 - 10.1 mm pp / pom black	909140007	-	
5501-129-003	Percussion rivet Pom black*	9046707164		
5500-774-7	Expanding nut Pa 6 black*	9018906013		
5501-132-005	Plastic expanding rivet Ø 10.0 Mm Pa 6 / Pom black*	57728AC090		

## Clips

Item No.	Item designation	Original No. 1	Original No. 2	image
5500-110-87	Interior trim clip colourless	6822LL	MU000504	
5500-110-100	ivet à impact noir	71741887	0940908327000	
5500-110-101	Impact rivet pom / ppo black	09409073085PK	987789	
5501-129-003	Percussion rivet Pom black*	9046707164		
5500-777-3	Drive rivet Ø 6.2 - 7.0 Mm Pa 6 black*	9046706017		



## Clips

Item No.	Item designation	Original No. 1	Original No. 2	image
5500-110-141	Interior trim clip	6777189104		
6464-012-244	Sealing ring aluminium 12x21x1,7	9043012031		
5500-110-87	Interior trim clip colourless	6822LL	MU000504	
5501-130-011	Impact rivet Toyota black			
5501-130-024	Percussion rivet Ø 8.9 - 9.1 Mm Pom / Pbt black*	5216116010		
5500-779-3	Sheet nut plastic black*	5387914010		
5500-785-083	Drive rivet Ø 6.0 Mm Pa 6 black*	5578552020		
5500-771-0	Expanding nut neutral*	9018904014		
5500-788-026	Expanding nut neutral*	9018906001		
5500-775-8	Expanding nut Pa 6 neutral*	9018906006		
5500-771-4	Expanding nut neutral*	9018906010		
5500-774-7	Expanding nut Pa 6 black*	9018906013		
5500-777-3	Drive rivet Ø 6.2 - 7.0 Mm Pa 6 black*	9046706017		
5501-130-010	Percussion rivet Pom / Ppo black*	9046707041		
5501-130-009	Percussion rivet black*	9046707066		
5501-129-003	Percussion rivet Pom black*	9046707164		

## Clips

Item No.	Item designation	Original No. 1	Original No. 2	image
5501-130-055	Plastic expanding rivet Ø 7.0 Mm Pbt / Pom black*	9046707166		
5500-785-087	Drive rivet Pa 66 black*	9046708145		
5501-132-004	Plastic expanding rivet Ø 8.0 Mm Pom / Pa Gf black*	9046708185		
5501-130-008	Percussion rivet black*	9046710183	9046707183	
5500-771-6	Plastic rivets without pin Ø 4.8 - 5.0 Mm black*			

## Clips

Item No.	Item designation	Original No. 1	Original No. 2	image
5500-110-138	Interior trim clip Volvo	30653441		
5500-110-137	Plastic expanding rivet black	8662958		



01

**Upholstery clamp pliers**

▶ Item no. 8714-02-10 | Upholstery clamp pliers

▶ Item no. 5500-500-08 | Upholstery clip

▶ Technical specifications

- Groove to stabilise the upholstery clamp
- Reversible spring, ensures firm hold of the upholstery clamp



02

**Assembly and trim wedge**

2-piece set

▶ Item no. 8715-57-700

▶ Technical specifications

- Dimensions of mounting wedge: 20.5 x 265 mm
- Dimensions of the trim wedge: 30 x 200 mm

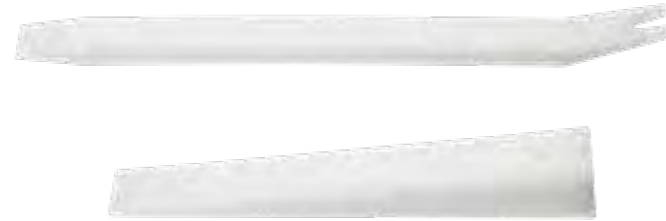

03

**Dismantling wedge**

for clips and clamps

▶ Item no. 8715-57-701

▶ Technical specifications

- extra narrow design
- made of metal
- with rubber coating to avoid paint damage
- Length 165 mm
- Fork opening 5 mm

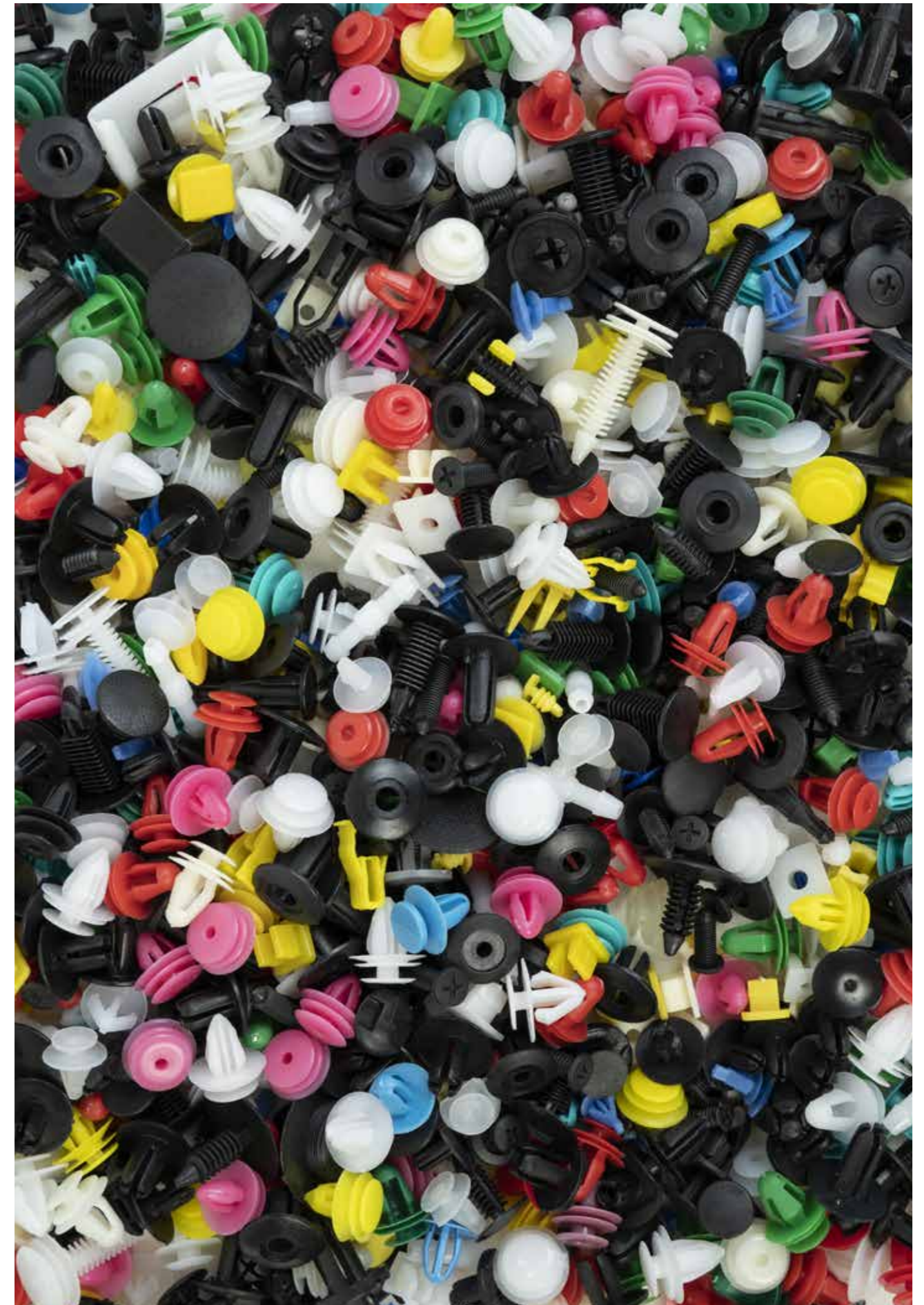





01

**Clips**

500-piece

► Item no. 1957-550

► Contents: 500 parts

- 50 x 5501-103-015 plastic expanding rivet black for 8mm hole
- 50 x 5500-940-5 Christmas tree clip Ford black plastic
- 50 x 5500-127-10 plastic expanding rivets black Opel / Audi / VW
- 50 x 5500-879-32 plastic expanding rivets, black
- 100 x 5500-500-08 upholstery clip
- 50 x 5500-201-404 plastic expanding rivets, black
- 100 x 5500-000-000 retaining clips V.A.G / FO
- 50 x 5500-130-11 plastic expanding rivets Opel / Audi / VW



02

**Clips**

160 pieces

► Item no. 1957-551

► Contents: 160 clips and brackets

- 10 x item no. 5500-130-11 PLASTIC SPREAD RIVET OPEL / AUDI / VW
- 10 x item no. 5500-201-404 PLASTIC SPREAD RIVET, BLACK
- 10 x item no. 5501-105-064 PLASTIC SPREAD RIVET FOR BUMPER
- 10 x item no. 5500-113-69 METAL NUTS ST 6.5MM VZ
- 10 x item no. 5500-523-14 PLASTIC SPREAD RIVET, BLACK
- 10 x item no. 5500-879-32 SPREADING NUT, BLACK
- 10 x item no. 5501-132-003 PLASTIC SPREAD RIVET, BLACK
- 10 x item no. 5500-113-65 TIN NUT ST 4.8MM VZ MATTE
- 10 x item no. 5500-115-77 TIN NUT ST 5,6MM VZ MATT MATT
- 10 x item no. 5500-940-5 FIR TREE CLIP FORD PA BLACK
- 10 x item no. 5500-127-10 PLASTIC SPREAD RIVET, BLACK
- 10 x item no. 5500-897-33 SPREADING NUT, BLACK
- 10 x item no. 5501-103-017 PLASTIC SPREAD RIVET WITH CAP SCHWA
- 10 x item no. 5501-529-80 BLIND RIVET, PLASTIC, BLACK
- 10 x item no. 5501-105-065 PLASTIC SPREAD RIVET, BLACK
- 10 x item no. 5500-939-5 PL PLUG, BLACK OPEL
- 1 x item no. 1958-001 ASSORTMENT BOX, PLASTIC 210 X 302
- 1 x item no. 1958-211 FOAM CUT-OUT FOR ASSORTMENTS
- 1 x item no. 1958-001-16 INLET FOR ASSORTMENT BOX KST16 COMPARTMENT



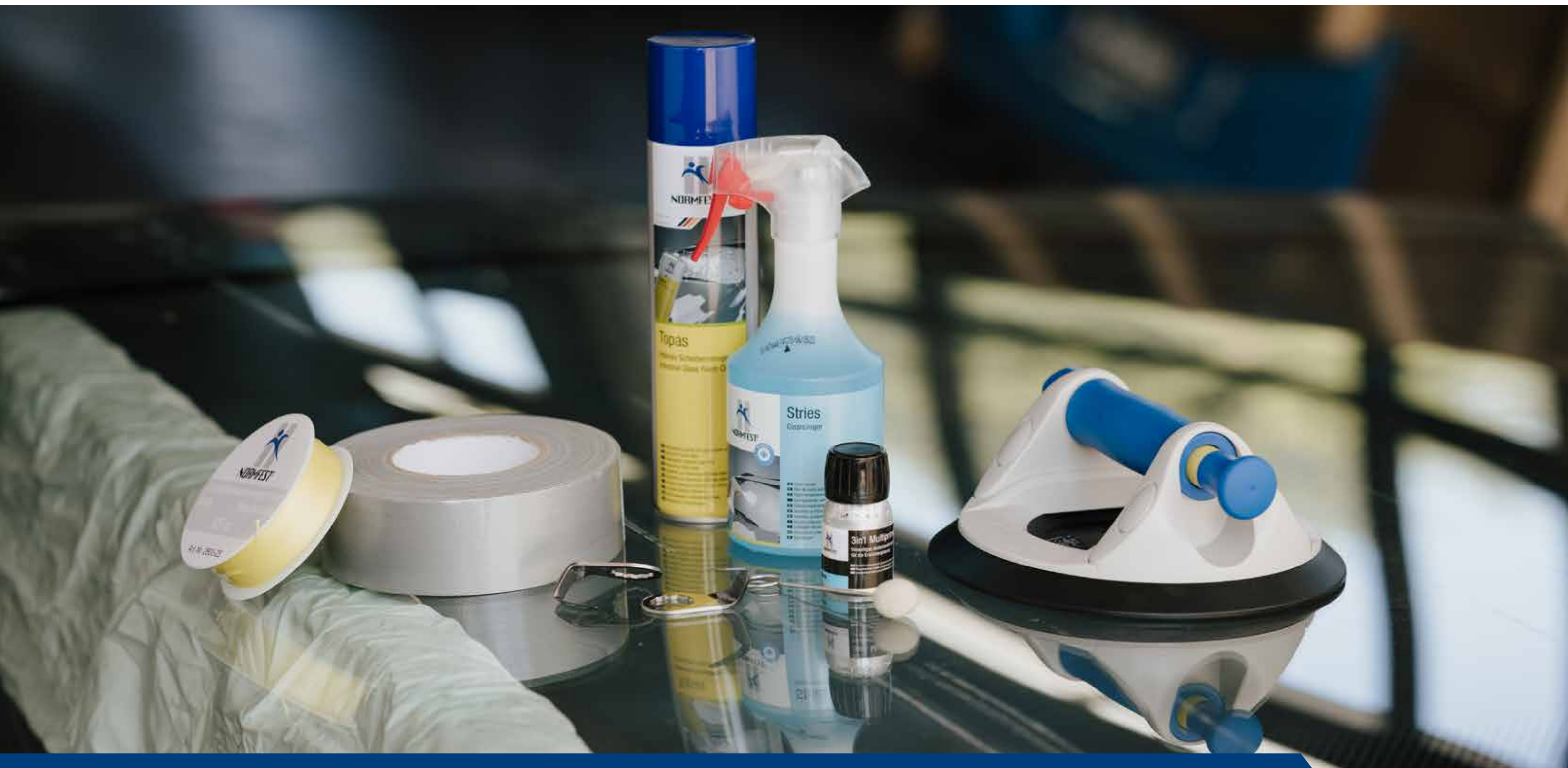

01

**Window cutting system**

Screenout Easy

- ▶ Item no. 2893-699-999
- ▶ Content: 11 pieces

## ▶ Technical specifications

- The discharge process can be carried out without great effort and without the need for an assistant
- Time saving due to easy and quick handling
- Clean and even cut without damaging the paintwork or the interior of the vehicle

## - Contents:

- 1x separating device (angled & with flexible rollers for the cord).
- 1x vacuum pump
- 2 x release cord (tensile force approx. 210 daN)
- 1 x piercing awl (art. no. 8715-57-68)
- 1 x cutter knife (item no. 8715-57-600)
- 1 x trim wedge (art. no. 8715-57-700)
- 1 x hook
- 1x angular gear
- 1x spare shaft
- 1x flexible shaft
- 1x threading aid
- 1 x adapter for bit inserts
- 2 x separating guards
- 1 x working instructions
- 1 x plastic case



02

**BIT adapter**

for screen removal set Screenout Easy

- ▶ Item no. 2893-699-990
- ▶ PU: 1



03

**Separation protection**

for screen removal set Screenout Easy

- ▶ Item no. 2893-699-991
- ▶ PU: 1



04

**Fastening hook**

for screen removal set Screenout Easy

- ▶ Item no. 2893-699-997
- ▶ PU: 1



05

**Angular gear**

for screen removal set Screenout Easy

- ▶ Item no. 2893-699-993
- ▶ PU: 1



06

**Flexible shaft**

for screen removal set Screenout Easy

- ▶ Item no. 2893-699-994
- ▶ PU: 1



07

**Cord holder**

for screen removal set Screenout Easy

- ▶ Item no. 2893-699-996
- ▶ PU: 1



08

**Vacuum pump**

for screen removal set Screenout Easy

- ▶ Item no. 2893-699-992
- ▶ PU: 1



09

**Sucker including pump**

for screen removal set Screenout Easy

- ▶ Item no. 2893-699-995
- ▶ PU: 1







01

**Cutting wire**

- ▶ Item no. 8715-57-63
- ▶ PU: 1
  
- ▶ Technical specifications
- especially for high-modulus window adhesives
- ideal for pulling
- Square
- Length: 50 m



02

**Piano cutting wire**

- ▶ Item no. 8715-57-64
- ▶ PU: 1
  
- ▶ Technical specifications
- drilled
- ideal for sawing
- Thickness: 0.6 mm
- Length: 20 m



03

**Pull handle**

- for disc separator wire
- ▶ Item no. 8715-57-65
  - ▶ PU: 1



04

**Pierce**

for disc separator wire

- ▶ Item no. 8715-57-66
- ▶ PU: 1



05

**Piercer (sword)**

for disc separator wire

- ▶ Item no. 8715-57-68
- ▶ PU: 1



06

**Counterholder**

for disc separator wire

- ▶ Item no. 8715-57-67
- ▶ PU: 1



01

**Washer cord**  
blue

- ▶ Item no. 2600-20
- ▶ PU: 1

- ▶ Technical specifications
- for heavy loads
- 240 dN tensile force
- oval shape
- silicone free
- 65m on one roll
- Colour blue



02

**Washer cord**  
orange

- ▶ Item no. 2600-24
- ▶ PU: 1

- ▶ Technical specifications
- for separating narrow, hard bonds
- 160 dN tensile force
- round shape
- silicone free
- 65m on one roll
- Color orange



03

**Washer cord**  
yellow, coated 65 m

- ▶ Item no. 2600-25
- ▶ PU: 1

- ▶ Technical specifications
- for Screenout Easy System 2893-699-999
- Thickness: 0.7 mm
- Tensile load 180 kg
- Shape: Round
- Surface: Smooth/fine structure/finished



04

**Assembly and trim wedge**  
2-piece set

- ▶ Item no. 8715-57-700
- ▶ PU: 1

- ▶ Technical specifications
- Dimensions of mounting wedge: 20.5 x 265 mm
- Dimensions of the trim wedge: 30 x 200 mm



05

**Window scraper**

- ▶ Item no. 8715-64-700 | Window scraper
- ▶ PU: 1
- ▶ Item no. 8715-64-71 | Spare blades
- ▶ PU: 10



06

**Cold cutting knife**

for use on side and rear windows

- ▶ Item no. 8697-603
- ▶ Knife, including 25 mm blades
- ▶ PU: 1
- ▶ Item no. 8697-604
- ▶ Spare blade, 19 mm
- ▶ PU: 2
- ▶ Item no. 8697-605
- ▶ Spare blade, 25 mm
- ▶ PU: 2





01

**PU scraper set**

ideal for cutting back the remaining adhesive bead

▶ Item no. 8715-57-690

▶ Technical specifications

- Content:

- 10 x replacement blades 12 mm (Item No. 8715-57-691)
- 10 x 16 mm replacement blades (Item No. 8715-57-692)
- 10 x replacement blades 20 mm (Item No. 8715-57-693)
- 1 x handle for PU scraper (item no.8715-57-694)



02

**Replacement handle**

for PU scrapers

▶ Item no. 8715-57-694

▶ PU: 1

▶ Technical specifications

- for blades in three different widths (12mm, 16mm, 20mm)
- screwdriver-like handle
- at the end with a screwable claw



03

**Ersatzklingen**

for PU scrapers

▶ Item no. 8715-57-691

▶ Breite: 12 mm

▶ PU: 10

▶ Item no. 8715-57-692

▶ Breite: 16 mm

▶ PU: 10

▶ Item no. 8715-57-693

▶ Breite: Angle grinder Ø 125 mm

▶ PU: 10



04

**Window cutter**

FEIN MULTIMASTER MM700

▶ Item no. 8697-6

▶ Technical specifications

- for removing glass from glued windows and working on the body
- Anti-vibration system (up to 70% less vibrations thanks to complete decoupling of the outer motor housing)
- permanently safe working
- permanent and overload-proof
- High-performance motor with a high copper content
- outstanding cutting speed
- Tachometer generator
- constant speeds even under load
- stepless electronic speed setting
- Metal gear (high load capacity and maximum service life)
- large action radius (5m fine-stranded rubber cable)
- Nominal consumption 450 W
- Power output 250 W

- Vibrations 10,000-19,500 rpm
- Hexagon tool holder
- Manual tool change with hexagon socket screw
- 
- Amplitude 2 x 1.7 degrees
- 5 m cable with plug
- Weight according to EPTA 1.45 kg
- 
- Scope of delivery:
- 1 x MULTIMASTER window cutter
- 1 x plastic tool case
- 1 x sharpening stone (Art.:8697-5-1)
- 1 x tensioning screw



05

**Round saw blade, fine**

▶ Item no. 8697-580-2

▶ Ø: 63 mm

▶ PU: 1

▶ Item no. 8697-581-2

▶ Ø: 80 mm

▶ PU: 1





01

**Window glazing system**

## Screenout

- ▶ Item no. 2893-999-999
- ▶ Content: 23 pieces
- 1 x puller (item no.8715-57-71)
- 1 x duct tape (Item No. 4992-380)
- 2 x suction cups (item no.8715-57-61)
- 2 x pull handles (Item No. 8715-57-65)
- 1 x piercing awl (item no.8715-57-68)
- 1 x handle (item no.8715-57-694)
- 10 x 16 mm blades (Item No. 8715-57-692)
- 1 x cutting wire (Item No. 8715-57-63)
- 1 x assembly and decorative strip wedge (item no. 8715-57-700)
- 1 x vacuum gel (Item No. 2600-15)
- 1 x cutter knife (Item No. 8715-57-600)
- 1 x storage box (Item No. 1962-1-4)



02

**Suction cup**

- ▶ Item no. 8715-57-61
- ▶ Technical specifications
- with double joint
- Load capacity: 30 kg
- Suction surfaces: Ø 150 mm, with suction mechanism
- Safety interlock
- highly tempered ABS plastic, acid and oil insensitive
- especially for curved panes
- swiveling joints





01

**Suction and fixation lifter**

- ▶ Item no. 8715-57-69
- ▶ Content: 6 pieces per PU

- ▶ Technical specifications
  - made of sturdy plastic
  - with high quality rubber suction cups
  - for fixing and pressing on decorative strips, window frames, emblems etc.
  - individual positioning options
  - Contact pressure can be regulated by means of a wing screw

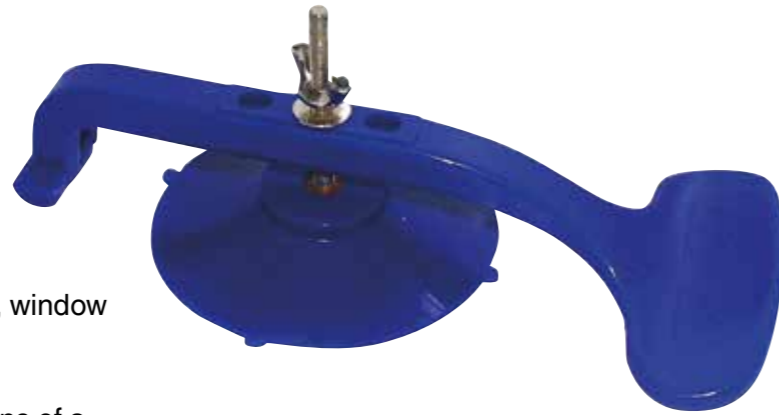

02

**Windshield stand**

- ▶ Item no. 7714-200

- ▶ Technical specifications
  - also for trucks and buses
  - no slipping thanks to special foam pads
  - max.load up to 120 kg
  - collapsible
  - 
  - Dimensions unfolded:
    - Height: 90 cm
    - Width: 90 cm
    - Depth: 60 cm
  - 
  - Folded height: 110 cm



03

**One-hand suction lifter**

- ▶ Item no. 8715-57-74

- ▶ Technical specifications
  - for curved and heavily structured surfaces
  - Suction cup diameter: 220mm
  - Load capacity 80kg
  - CE mark
  - Safety display on the vacuum pump
  - One-hand operation with vacuum pump
  - also for gas-tight surfaces such as glass, metal, marble, coated wood and plastic
  - Direction of support: parallel
  - compact size
  - Special plastic
  - the radius to be sucked in must be at least 500mm



04

**Pump suction cups**

- ▶ Item no. 8715-57-610

- ▶ Technical specifications
  - Ø 210 mm
  - With its load capacity of 120 kg, it is particularly suitable for use in trucks and commercial vehicles
  - non-slip grip coating
  - with safety marking
  - Safety tested by TÜV-Nord





01  
**Disk cutting knife U-shape**  
ideal for removing glass under the bonnet, short leg, set of 2

Item No.	Cutting length	shape
8697-005-108	16 mm	108
8697-005-118	19,5 mm	118
8697-005-115	22 mm	115
8697-005-076	24 mm	076
8697-005-163	28 mm	163
8697-005-147	32 mm	147
8697-005-079	36 mm	079
8697-005-110	40 mm	110
8697-005-155	70 mm	155
8697-005-101	60 mm	101



02  
**Disk cutting knife U-shape**  
ideal for removing glass under the bonnet, long leg, set of 2

Item No.	Cutting length	shape
8697-005-114	32 mm	114
8697-005-191	32 mm	191
8697-005-154	45 mm	154
8697-005-153	52 mm	153
8697-005-107	60 mm	107



03  
**Disk cutting knife U-shape**  
reinforced version, set of 2

Item No.	Cutting length	shape
8697-005-157	60 mm	



04  
**Disk cutting knife U-shape**  
with saw tooth, reinforced version, set of 2

Item No.	Cutting length	shape
8697-005-211	25,5 mm	211
8697-005-212	38 mm	212



05  
**L-shaped slicing knife**  
toothed, set of 2

Item No.	Cutting length	shape
8697-009-208	19 mm	208
8697-009-207	25,4 mm	207
8697-009-209	38 mm	209



06  
**Slicing knife**  
straight shape, set of 2

Item No.	Cutting length	length	shape
8697-001-121	26 mm	56 mm	121
8697-001-176	40 mm	90 mm	176
8697-002-194	35 mm	110 mm	194



07  
**Slicing knife**  
Z-bend, set of 2

Item No.	Cutting length	length	shape
8697-002-123	32 mm	110 mm	123
8697-002-171	70 mm	120 mm	171



08  
**Slicing knife**  
curved, set of 2

Item No.	Cutting length	angle	length	shape
8697-006-120	14 mm	90°	65 mm	120
8697-006-103	20 mm	50°	75 mm	103



09  
**Slicing knife**  
curved, Z-bend, set of 2

Item No.	Cutting length	length	shape
8697-002-168	45 mm	120 mm	168
8697-002-125	70 mm	120 mm	125



10  
**Slicing knife**  
Z-bend, with fixed depth stop, set of 2

Item No.	Cutting length	length	shape
8697-002-097	58 mm	125 mm	097





01  
**Slicing knife**  
Z-bend, with adjustable depth stop, set of 2

Item No.	Cutting length	length	shape
8697-003-143	16-43 mm	100 mm	143
8697-004-169	60-76 mm	120 mm	169



02  
**Slicing knife**  
flat, with adjustable depth stop, set of 2

Item No.	Cutting length	length	shape
8697-004-182	42-60 mm	145 mm	182



03  
**Slicing knife**  
Z-bend, bent, with fixed depth stop, set of 2

Item No.	Cutting length	length	shape
8697-002-160	54 mm	120 mm	160



04  
**Slicing knife, curved shape**  
Z-bend, with fixed depth stop, set of 2

Item No.	Cutting length	length	shape
8697-004-152	39 mm	85 mm	152



05  
**Slicing knife, curved shape**  
Z-bend, with adjustable depth stop, set of 2

Item No.	Cutting length	length	shape
8697-004-195	32-46 mm	110 mm	195



06  
**Slicing knife straight shape**  
suitable for round recesses in plastics, toothed, set of 2

Item No.	Cutting length	length	shape
8697-001-073	35 mm	56 mm	073



07  
**Slicing knife**  
suitable for removing body parts, Z-bend, toothed, set of 2

Item No.	Cutting length	length	shape
8697-002-081	60 mm	120 mm	081



08  
**Slicing knife, curved shape**  
Z-bend, set of 2

Item No.	Cutting length	length	shape
8697-003-072	45 mm	80 mm	072



09  
**Disk cutting knife U-shape**  
with extended bridge, set of 2

Item No.	Cutting length	shape
8697-005-156	40 mm	156



10  
**Scraper to remove? Remaining adhesive beads**  
Shovel shape, with anti-scratch coating, set of 2

Item No.	Cutting length	length	shape
8697-007-129	12 mm	64 mm	129
8697-007-146	18 mm	65 mm	146



11  
**Scraper knife set**  
Set of 2

Item No.	Cutting length	shape
8697-007-113	13 mm	113 and 131

12  
**Sharpening stone for cutting knife**

► Item no. 8697-5-1

- Technical specifications
- for sharpening the knife before use
- for an optimal cut





01

**„Cut“ protective glove**

- ▶ Technical specifications
- PU coating on the palm and fingertips
- flexible
- excellent sense of touch
- high abrasion resistance
- good cut protection (level 3) thanks to Dyneema® fiber
- mechanical resilience
- EN standards / performance values:
- EN 388
- Achievement rating 4343

Item No.	size	Packing unit	Quantity per box
7798-005-8	8	1	6/72
7798-005-9	9	1	6/72
7798-005-10	10	1	6/72
7798-005-11	11	1	6/72

02

**„Cut-Pro“ protective glove**

- ▶ Technical specifications
- highest cut protection level 5
- special fiber knitted glove
- Color gray
- silicone free
- black nitrile coating on palm and fingertips
- with knitted waistband
- highest wearing comfort
- highest dexterity
- Production according to EN388 CAT2

Item No.	size	Packing unit	Quantity per box
7798-022-8	8	1	72
7798-022-9	9	1	72
7798-022-10	10	1	72
7798-022-11	11	1	72





01  
**Pro-Vision safety glasses**  
with laminated glass

► Item no. 4695-006-500

- Technical specifications
- Glasses in a sporty design protect the eyes at work thanks to shatterproof laminated glass



02  
**VISION Protect protective goggles**  
with UV protection

► Item no. 7794-005-0

- Technical specifications
- intended for long-term use
  - soft nose pads
  - flexible and soft temples
  - safety goggles
  - Body black / transparent
  - Clear windows
  - Ultraviolet protection filter
  - good color recognition
  - very high wearing comfort
  - UV 400 protection



03  
**X-one safety glasses**  
scratch-resistant coating

► Item no. 7794-001-0

- Technical specifications
- scratch-resistant coated
  - very light glasses (28g)
  - sporty design
  - Highest UV protection (100%)
  - universal fit despite simple temples



04  
**Astrospec safety glasses**  
Polycarbonate lens

► Item no. 7794-002-0

► Item no. 7794-002-01 | Spare lenses

- Technical specifications
- Permanently fog-free inside
  - extremely scratch-resistant on the outside
  - Soft component on the temple for increased comfort
  - good adaptability thanks to 4-stage temple length adjustment
  - very easy to change discs
  - 100% UV protection



01

**Window adhesive**

Screenox Quantum

- ▶ Item no. 2893-506-10
- ▶ Content: Engine sealer Cartridge
- ▶ Quantity per box: 12



- ▶ Item no. 2893-506-30
- ▶ Content: Starter Set Bag
- ▶ Quantity per box: 12

▶ **Technical specifications**

- 1-component PUR window adhesive
- Drive away time: 60 minutes with double airbag
- Temperature range: -10 ° C to 35 ° C
- Glazing time: 15 minutes
- high modulus
- antenna compatible
- very short thread breakage
- very good stability
- meets the requirements of the original equipment manufacturer
- not conductive
- solvent-free
- cold workable
- applicable without activator
- Compatible with MS polymers and thus processable on cut back MS adhesive beads
- very easy squeezing



02

**Window adhesive set**

Screenox Quantum

- ▶ Item no. 2893-506-20
- ▶ Content: 300 ml Cartridge
- ▶ Quantity per box: 24



- Set content:
- 1 x Screenox Quantum window adhesive 300 ml cartridge
- 1 x 3in1 multiprimer 30 ml
- 1 x primer brush
- 1 x cartridge tip
- 1 x instructions



03

**Window adhesive set**

Screenox Quantum



- ▶ Item no. 2893-506-40
- ▶ Content: Starter Set Bag
- ▶ Quantity per box: 24

- Set content:
- 1 x Screenox Quantum window adhesive 400 ml bag
- 1 x 3in1 multiprimer 30 ml
- 1 x primer brush
- 1 x cartridge tip
- 1 x bag adapter
- 1 x instructions





01

**Window adhesive**

Screenox Cold

- ▶ Item no. 2893-504-10
- ▶ Content: Cartridge 300 ml
- ▶ Quantity per box: 12
  
- ▶ Item no. 2893-504-30
- ▶ Content: 400 ml pouch
- ▶ Quantity per box: 12

▶ **Technical specifications**

- 1-component PU window adhesive
- Drive-away time: without airbag 60 minutes, with double airbag 2 hours
- Temperature range: 23 ° C, 50% relative humidity
- Glazing time: 15 minutes
- universal modular
- antenna compatible
- short thread break
- good stability
- meets the requirements of the original equipment manufacturer
- not conductive
- solvent-free
- cold workable
- applicable without activator
- including tips



02

**Window adhesive set**

Screenox Cold

- ▶ Item no. 2893-504-20
- ▶ Content: 300 ml
- ▶ Quantity per box: 24

- 1 x 300 ml cartridge window adhesive  
Screenox Cold - New Generation
- 1 x 3in1 multiprimer 30 ml
- 1 x primer brush
- 1 x cartridge tip
- 1 x instructions



03

**Window adhesive set**

Screenox Cold

- ▶ Item no. 2893-504-40
- ▶ Content: 400 ml
- ▶ Quantity per box: 24

- 1 x 400 ml bag of window adhesive  
Screenox Cold - New Generation
- 1 x 3in1 multiprimer 30 ml
- 1 x primer brush
- 1 x bag adapter
- 1 x cartridge tip
- 1 x instructions





01

### Glass and paint primer 3 in 1 multiprimer

- ▶ Item no. 2893-580-30
- ▶ Content: 30 ml
- ▶ Quantity per box: 24
  
- ▶ Item no. 2893-580-100
- ▶ Content: 100 ml
- ▶ Quantity per box: 8
  
- ▶ Technical specifications
- versatile pretreatment product for replacement glazing
- Adhesion promoter, UV and rust protection in one operation
- elastic primer



02

### Brush for primer made of cotton

- ▶ Item no. 2893-540
- ▶ PU: 10



03

### Glass-to-metal glue Mirrlock

- ▶ Item no. 2898-557
- ▶ Content: 5 pcs.
- ▶ PU: 1
  
- ▶ Technical specifications
- 2-component adhesive
- Temperature resistance: -55 ° C to 120 ° C
- non-contact: after approx. 20 seconds
- Hardening: approx. 12 hours at 23 ° C and 55% humidity
- Tensile strength: approx. 35 N / mm<sup>2</sup> (broken glass)?

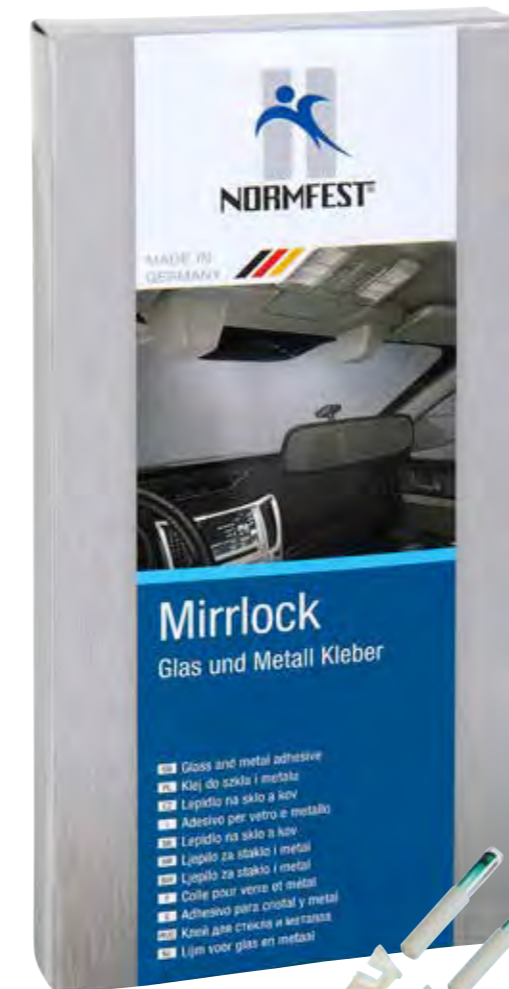

04

### Washer sealant Screenfit

- ▶ Item no. 2893-220
- ▶ Content: 310 ml
- ▶ Quantity per box: 12
  
- ▶ Technical specifications
- can be dabbed off
- resistant to water, road salt and weather influences
- After setting, the temperature resistance is -30 ° C to 80 ° C





01  
**Round nozzle**  
for aluminum cartridges with embossing

- ▶ Item no. 2891-02-25
- ▶ PU: 25

- ▶ Technical specifications
- Length: 8.2 cm



02  
**Triangular nozzle**  
for window adhesive

- ▶ Item no. 2891-02-30
- ▶ PU: 25

- ▶ Technical specifications
- with stop



03  
**Bag adapter**  
for 400 ml bags

- ▶ Item no. 2893-560
- ▶ PU: 1

- ▶ Content:
- 1 x bag adapter
- 2 x round nozzle (Item No. 2891-02-25)



04  
**opener**  
for cartridges

- ▶ Item no. 2891-02-50
- ▶ PU: 1



05  
**Duct tape**  
Length: 50 m

- ▶ Technical specifications
- textile reinforced
- high tensile strength
- very good adhesive strength



Item No.	Width:	Colour:	PU	Quantity per box
4992-390	38 mm	black	1	24
4992-380	38 mm	silver	1	24
4992-370	50 mm	black	1	24
4992-360	50 mm	silver	1	24

06  
**Spacer**  
Universal

- ▶ Item no. 5502-100-001
- ▶ PU: 5



07  
**Reset profile**  
for side and rear windows

- ▶ Item no. 5502-107-002
- ▶ PU: 1

- ▶ Technical specifications
- 27m roll
- self-adhesive
- universally applicable



08  
**Moss ribbon**

- ▶ Item no. 5502-107-001
- ▶ PU: 1

- ▶ Technical specifications
- Foam profile
- including hard rubber block
- 5 x 7mm
- self-adhesive
- on a 15 meter roll



09  
**Moss ribbon**

- ▶ Item no. 5502-107-003
- ▶ PU: 1

- ▶ Technical specifications
- Foam profile
- 4 x 3mm
- self-adhesive
- on a 30 meter roll



10  
**Windshield stop**  
BMW E36 / E38 / E39

- ▶ Item no. 5502-101-003
- ▶ PU: 1 sales unit = 56 pieces = 1 pallet





01

**Glass cleaner**  
Stries Protect



- ▶ Item no. 2897-340
- ▶ Content: Aquano
- ▶ Quantity per box: 12
  
- ▶ Item no. 2897-340-5
- ▶ Content: Uni-Star
- ▶ PU: 1
  
- ▶ Item no. 2897-340-30
- ▶ Content: 30 liters
- ▶ PU: 1

- ▶ Technical specifications
- Leaves behind clear, shiny, streak-free and clean glass surfaces
- removes dirt, stains, fingerprints, grease, nicotine, flies, etc.
- can be used on glass and polycarbonate glass
- silicone and ammonia free
- has no abrasives



02

**Pouring tap**

- ▶ Item no. 2000-000-005
- ▶ for 5 liter containers
- ▶ PU: 1
  
- ▶ Item no. 2000-000-030
- ▶ for 30 litre container
- ▶ PU: 1

03

**Intensive window cleaner**  
topaz

- ▶ Item no. 2897-310
- ▶ Content: 400 ml
- ▶ Quantity per box: 24
  
- ▶ Item no. 2000-03
- ▶ Content: 5 litres Concentrate
- ▶ PU: 1

- ▶ Technical specifications
- silicone free
- also suitable for polycarbonate glass
- does not attack surfaces
- Foam formation only after the surface has been wetted with the material



**Pouring tap**

- ▶ Item no. 2000-000-005
- ▶ for 5 liter containers
- ▶ PU: 1

04

**Active cleaning wipes**  
Active-Clean

- ▶ Item no. 2897-260-70
- ▶ Content: 75 wipes
- ▶ PU: 1

- ▶ Technical specifications
- with lemon smell
- lint free
- dermatologically tested
- The cleaning cloths remove even body, plastic and window adhesive residues effortlessly





01

**Craft knife**

including a spare blade

- ▶ Technical specifications
- adjustable and exchangeable blade
- Blade mounted in a metal guide
- The blade can be locked



Item No.	execution	Packing unit
8715-57-600	Cutter knife	1
8715-57-601	Replacement blades	10
8715-57-606	Replacement blades, extra sharp	10

02

**Cutter knife narrow**

made of sheet steel

- ▶ Technical specifications
- Material: sheet steel
- Length: 13 cm
- Width: 1 cm
- Blade width: 0.9 cm



Item No.	execution	PU
8715-57-602	Cutter knife	1
8715-57-603	Replacement blades	10

03

**Safety knife**

Martor quality

- ▶ Technical specifications
- TÜV approved
- automatic blade retraction
- very good cutting properties
- universally applicable
- Handle made of high quality plastic
- The knife lies comfortably in the hand



Item No.	execution	PU
8715-57-604	Safety cutter knife	1
8715-57-605	Spare blades 10 pieces.	10

04

**Normfest Cutter Knife**

plastic

- ▶ Technical specifications
- sturdy plastic
- rubberised sheathing for a firm grip
- easy and safe replacement of the blade
- with one black blade



Item No.	execution	PU
7716-060-1	Normfest Cutter Knife Plastic	1
8715-57-606	Replacement blades, extra sharp	10

05

**Normfest Cutter Knife**

Heavy Duty

- ▶ Technical specifications
- made of full metal
- for tough use
- easy and safe replacement of the blade
- with a black blade



Item No.	execution	PU
7716-060-2	Normfest Cutter Knife Full Metal Heavy Duty	1
8715-57-606	Replacement blades, extra sharp	10

06

**Normfest safety cutter knife**

- ▶ Technical specifications
- with 2 function levels
- automatic retraction when the blade is not in use
- lock for the permanently extended blade
- with one black trapezoid blade



Item No.	execution	PU
7716-060-3	Normfest safety cutter knife	1
8715-57-607	Replacement blade	10

01

**Rockfall repair system**

Screen repair

- ▶ Item no. 2600-999-999
- ▶ Content: 25-piece

- 10 x scraper (Item No. 2600-01)
- 1 x drilling machine: 12 volts with chuck (Item No. 2600-04)
- 1 x diamond cutter: 1.2 mm
- 1 x joint mirror with suction cup (Item No. 2600-06)
- 2 x glass drill: 1.2 mm (Item No. 2600-07)
- 1 x hardening film (Item No. 2600-08)
- 1 x lapping polisher (Item No. 2600-09)
- 1 x polish (Item No. 2600-10)
- 1 x repair resin (Item No. 2600-11)
- 1 x finish resin (Item No. 2600-12)
- 1 x LED UV lamp: 230 volts with timer (Item No. 2600-13-12)
- 1 x vacuum gel (Item No. 2600-15)
- 1 x tool holder with spring capsule (Item No. 2600-16)
- 1 x transformer: 220 volts (Item No. 2600-045)
- 1 x LED inspection lamp (item no. 3721-503)



02

**LED UV lamp 12V**

Part of the screen repair case

- ▶ Item no. 2600-13-12
- ▶ PU: 1
- ▶ Technical specifications
  - with timer function (approx. 2 minutes)
  - can only be operated with an adapter cable 12 V (Item No. 2600-17)



03

**LED inspection lamp**

Part of the screen repair case

- ▶ Item no. 3721-503
- ▶ PU: 1
- ▶ Technical specifications
  - extra reinforced clip (break-proof)
  - Housing made of aluminum
  - Light source: 5 mm LED
  - Length: 125 mm / ø head 12 mm
  - including batteries (2x AAA, micro)
  - constant light output
  - with clip torque switching



04

**Transformer 220V**

Part of the screen repair case

- ▶ Item no. 2600-045
- ▶ PU: 1





01

**12V drill**

Part of the screen repair case

- ▶ Item no. 2600-04
- ▶ PU: 1
- ▶ Technical specifications
- with chuck
- suitable for window repairs



02

**12V adapter cable**

- ▶ Item no. 2600-17
- ▶ PU: 1
- ▶ Technical specifications
- suitable for UV lamp 12V (Art.No. 2600-13-12) and drill 12V (Art.No. 2600-04)



03

**Drive for diamond drills**

for drill (Item No. 2600-04)

- ▶ Item no. 2600-02
- ▶ PU: 1



04

**Drill guide**

for drill (Item No. 2600-04)

- ▶ Item no. 2600-03
- ▶ PU: 1



05

**Hand drill**

- ▶ Item no. 2600-21
- ▶ PU: 1
- ▶ Technical specifications
- Diameter: 1.6mm
- for efficient, gentle drilling in the windshield
- enables the repair resin to reach all areas of the rockfall
- prevents too deep and strenuous drilling and slipping



06

**Handle**

- ▶ Item no. 2600-23
- ▶ PU: 1
- ▶ Technical specifications
- for hand drill (Art.-No. 2600-23)



07

**Tool holder**

Part of the screen repair case

- ▶ Item no. 2600-16
- ▶ PU: 1
- ▶ Technical specifications
- the swivel arm enables precise filling of the resin
- made of metal



08

**Lapping polisher**

Part of the screen repair case

- ▶ Item no. 2600-09
- ▶ PU: 1



09

**Glass drill**

Part of the screen repair case

- ▶ Item no. 2600-07
- ▶ PU: 1
- ▶ Technical specifications
- Diameter: 1.2mm
- 2 pieces per packaging unit



10

**Metal drill**

for window repairs

- ▶ Item no. 2600-22
- ▶ PU: 1
- ▶ Technical specifications
- Diameter: 1.6mm



11

**Hardening film**

Part of the screen repair case

- ▶ Item no. 2600-08
- ▶ PU: 1



12

**Scraper blades**

Part of the screen repair case

- ▶ Item no. 2600-01
- ▶ PU: 10 piece



13

**Articulated mirror with suction cup**

Part of the screen repair case

- ▶ Item no. 2600-06
- ▶ PU: 1





Vehicle reworking



## 1 Waschen & Reinigen



**Wash & Ready**  
Autoshampoo  
Art. 2000-321-5, 5 Liter  
Art. 2000-321-30, 30 Liter



**All-Star Protect**  
Kraftreiniger innen/außen  
Art. 2000-318-5, 5 Liter  
Art. 2000-318-30, 30 Liter



**Magic-Clean**  
Reinigungsknete  
Art. 2000-25, 200g



**Magic-Clean Rot**  
Scharfe Reinigungsknete  
Art. 2000-26, 200g



**Magic-Clean Tuch**  
Mikrofaser Tuch 30 x 30 cm  
mit Reinigungsknete  
Art. 2000-27

## Spezialprodukt



**Surface Control**  
Hochaktiver Reiniger, Entfetter  
und Kontrollspray  
Art. 2000-28-185, 185 ml  
Art. 2000-28-5, 5 Liter

## Maschinen



**Mini-Poliermaschine**  
mit Druckluft-Anschluss  
inkl. Kletteller, Ø 75 mm  
max. 5.500 rpm  
Art. 8696-540-004



**Exzenter Poliermaschine**  
Tornador, Ø 150 mm  
Art. 8697-114-13



**Ersatzteller**  
für Mini-Poliermaschine  
Art. 8696-540-050, Ø 50 mm  
Art. 8696-540-075, Ø 75 mm

**Kletteller**  
für Exzenter-Poliermaschine  
Art. 8697-114-132, Ø 150 mm



## 2 Diagnose Lack

### Tiefe, starke Kratzer



### Viele starke Kratzer

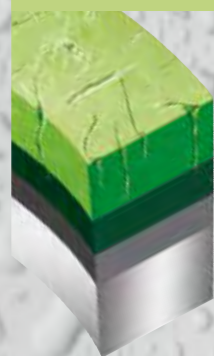

### Mittlere Kratzer



### Leichte Kratzer + Hologramme

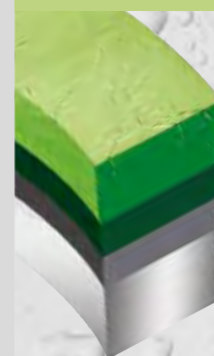

### Leichte Kratzer + Hologramme / Lack- und Wachsversiegelung



### Lack- und Wachsversiegelung

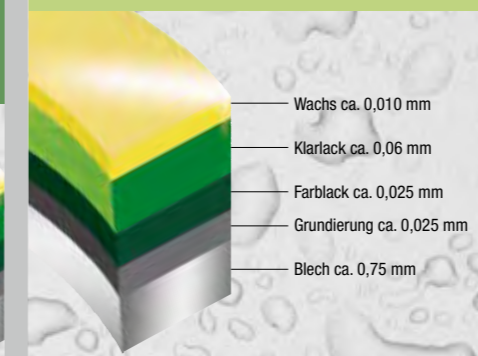

- Wachs ca. 0,010 mm
- Klarlack ca. 0,06 mm
- Farblack ca. 0,025 mm
- Grundierung ca. 0,025 mm
- Blech ca. 0,75 mm



## 3 Produkte



**Scratch Cut**  
Hochleistungs-Schleifpaste  
Art. 2000-341-500, 500 g



**Scratch Finish**  
Hochglanz-Antihologramm-Politur  
Art. 2000-343-500, 500 g



**Compact**  
Schleifen-Polieren-Versiegeln  
in einem Arbeitsschritt  
Art. 2000-335-1, 1 kg



**Perl**  
Langzeit Oberflächen-  
schutzversiegelung  
Art. 2897-327, 500 ml  
Art. 2897-327-5, 5 Liter



**Speed Gloss Nano**  
Schnellversiegelung  
Art. 2000-316-1, 1 Liter  
Art. 2000-316-5, 5 Liter



**Premium Wax**  
Carnauba-Wachsversiegelung  
Art. 2000-330-200, 200 ml



**Ceramic Shield 9H**  
Keramik Quarz Langzeitversiegelung  
30 ml Set  
Art. 2000-333



## 4 Anwendung

Rotative Maschinen: 600 – 1.200 U/min  
Exzenter Maschinen: 1.700 – 2.200 U/min



- Verarbeitung**
- Natur Lammfell  
Art. 2000-350-75, Ø 75 mm  
Art. 2000-350-150, Ø 150 mm
  - Polierschwamm hard, gelb  
Art. 2000-351-75, Ø 75 mm  
Art. 2000-351-150, Ø 150 mm
  - Polierschwamm medihard, weiß  
Art. 2000-357-80, Ø 80 mm  
Art. 2000-357-150, Ø 150 mm

- Nachpolieren**
- Microfasertuch rot, Art. 2000-740-40

Rotative Maschinen: 600 – 1.500 U/min  
Exzenter Maschinen: 1.700 – 2.200 U/min



- Verarbeitung**
- Polierschwamm medihard, weiß  
Art. 2000-357-80, Ø 80 mm  
Art. 2000-357-150, Ø 150 mm
  - Polierschwamm medium, orange  
Art. 2000-352-75, Ø 75 mm  
Art. 2000-352-150, Ø 150 mm

- Nachpolieren**
- Microfasertuch lila, Art. 2000-940-60
  - Microfasertuch türkis, Art. 2000-940-40
  - Premium Microfasertuch, grau  
Art. 2000-745-40

Rotative Maschinen: 600 – 1.500 U/min  
Exzenter Maschinen: 1.700 – 2.600 U/min



- Verarbeitung**
- Polierschwamm medihard, weiß  
Art. 2000-357-80, Ø 80 mm  
Art. 2000-357-150, Ø 150 mm
  - Polierschwamm medium, orange  
Art. 2000-352-75, Ø 75 mm  
Art. 2000-352-150, Ø 150 mm

- Nachpolieren**
- Microfasertuch lila, Art. 2000-940-60
  - Microfasertuch türkis, Art. 2000-940-40
  - Premium Microfasertuch, grau  
Art. 2000-745-40

Rotative Maschinen: 1.000 – 2.000 U/min  
Exzenter Maschinen: bis zu 4.200 U/min

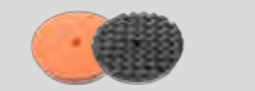

- Verarbeitung**
- Polierschwamm medium, orange  
Art. 2000-352-75, Ø 75 mm  
Art. 2000-352-150, Ø 150 mm
  - Waffel-Polierschwamm, schwarz  
Art. 2000-354-75, Ø 75 mm  
Art. 2000-354-150, Ø 150 mm

- Nachpolieren**
- Premium Microfasertuch, grau  
Art. 2000-745-40
  - Premium Microfasertuch, blau  
Art. 2000-840-60

Exzenter Maschinen: 1.700 – 2.200 U/min



- Verarbeitung**
- Polierschwamm medium, orange  
Art. 2000-352-75, Ø 75 mm  
Art. 2000-352-150, Ø 150 mm
  - Polierschwamm soft, schwarz  
Art. 2000-353-75, Ø 75 mm  
Art. 2000-353-150, Ø 150 mm
  - Waffel-Polierschwamm, schwarz  
Art. 2000-354-75, Ø 75 mm  
Art. 2000-354-150, Ø 150 mm
  - Applikationsschwamm zur Handverarbeitung, schwarz  
Art. 2000-209-130, Ø 130 mm

Exzenter Maschinen: 1.700 – 2.200 U/min



- Verarbeitung**
- Premium Microfasertuch, grau  
Art. 2000-745-40
  - Premium Microfasertuch, blau  
Art. 2000-840-60

Exzenter Maschinen: 1.700 – 2.200 U/min



- Verarbeitung**
- Applikationsschwamm zur Handverarbeitung, schwarz, Art. 2000-209-130, Ø 130 mm
  - Premium Microfasertuch, grau  
Art. 2000-745-40
  - Premium Microfasertuch, blau  
Art. 2000-840-60

Exzenter Maschinen: 1.700 – 2.200 U/min

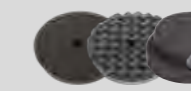

- Verarbeitung**
- Polierschwamm soft, schwarz  
Art. 2000-353-75, Ø 75 mm  
Art. 2000-353-150, Ø 150 mm
  - Waffel-Polierschwamm, schwarz  
Art. 2000-354-75, Ø 75 mm  
Art. 2000-354-150, Ø 150 mm
  - Applikationsschwamm zur Handverarbeitung, schwarz, Art. 2000-209-130, Ø 130 mm
  - Premium Microfasertuch, grau  
Art. 2000-745-40
  - Premium Microfasertuch, blau  
Art. 2000-840-60

Exzenter Maschinen: 1.700 – 2.200 U/min



- Produkteigenschaften**
- Ultimative Keramik-Langzeitversiegelung
  - kratztbeständig 9H
  - Maximaler Glanz
  - UV-Schutz
  - leicht zu Verarbeiten
  - die Oberfläche ist nach Auftragen bis zu 3 Jahre versiegelt





01

**Cleaning clay**

Magic clean

- ▶ Item no. 2000-25
- ▶ Content: 200 g
- ▶ colour: blau
- ▶ PU: 1

▶ Technical specifications

- gently removes even extreme soiling from painted surfaces
- without aggressive solvents
- removes industrial dust, rust film, paint mist, insect residues, glue residues, tar and resin deposits

02

**Cleaning clay sharp**

Magic clean

- ▶ Item no. 2000-26
- ▶ Content: 200 g
- ▶ colour: red
- ▶ PU: 1

▶ Technical specifications

- sharp cleaning clay
- removes all stubborn deposits from paintwork and rims
- such as rust film, brake dust, tar, tree resins, insects, burnt-in metal dust and much more ...
- Delivery in a resealable box

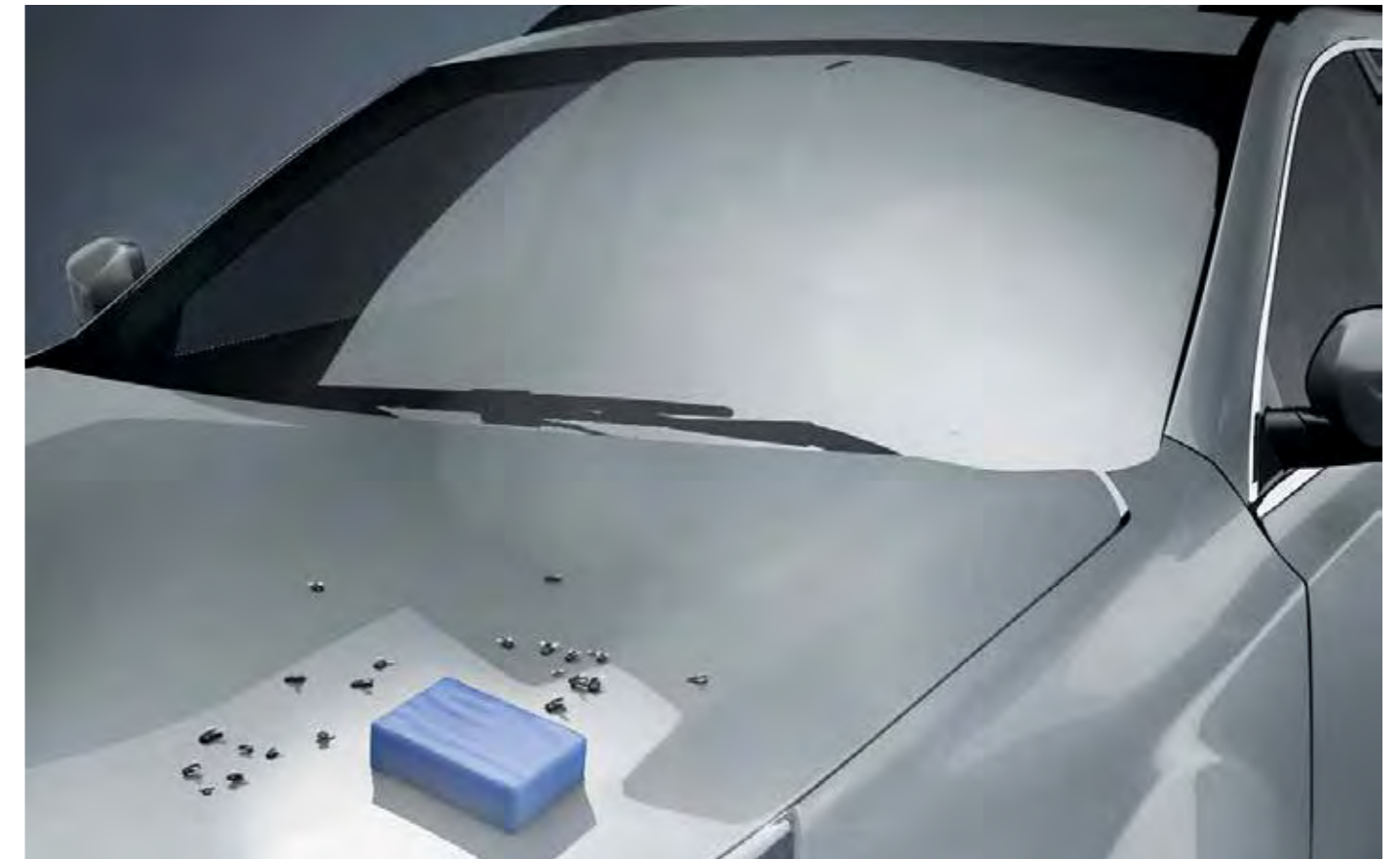

03

**High quality microfiber cloth with cleaning clay**

Magic-Clean cloth

- ▶ Item no. 2000-27

▶ Technical specifications

- for quick removal of stubborn surface dirt
- for fast and efficient work
- removes residues and spray mist
- lasts up to 5 times longer than cleaning clay
- washable
- 30 x 30 cm





**High-performance grinding paste**  
Scratch Cut

- ▶ Item no. 2000-341-500
- ▶ Content: 500 g
- ▶ Quantity per box: 6

▶ **Product description**

- Polishing paste for the 1st step of our 2-step polishing system
- extremely quickly and perfectly to the desired reprocessing goal
- extremely high removal rate with DRA technology
- high gloss level
- silicone and ammonia free
- free from gloss enhancers
- long processing time
- is suitable for all automotive

**High gloss anti-hologram polish**  
Scratch Finish

- ▶ Item no. 2000-343-500
- ▶ Content: 500 g
- ▶ Quantity per box: 6

▶ **Product description**

- Polish for the 2nd step of our 2-step polishing system
- ultra fine abrasive with DRA technology
- silicone and wax free
- suitable for all automotive paint systems including cellulose, 1K



matching:  
Microfiber cloth  
Item No. 2000-740-40



matching:  
Microfiber cloth  
Item No. 2000-745-40



matching:  
Microfiber cloth  
Item No. 2000-940-60



01  
**Lambskin**  
Color white

Item No.	Ø mm	PU
2000-350-75	75	4
2000-350-150	150	2



02  
**Polishing sponge medihard**  
for scratch cut

Item No.	Ø mm	PU
2000-357-80	80	4
2000-357-150	150	2



03  
**Polishing sponge medium**  
medium removal, orange

Item No.	Ø mm	PU
2000-352-75	75	4
2000-352-150	150	2



04  
**Waffle polishing sponge**  
for very easy removal, black

Item No.	Ø mm	PU
2000-354-75	75	4
2000-354-150	150	2





**01 Highly active cleaner, degreaser and control spray**  
Surface Control

- ▶ Item no. 2000-28-185
- ▶ Content: Surface Control
- ▶ Quantity per box: 6
- ▶ Item no. 2000-28-5
- ▶ Content: Uni-Star
- ▶ PU: 1



- ▶ **Technical specifications**
- effective and very effective cleaner in a refillable dosing pump bottle
- excellent degreasing properties
- Effectively removes all conventional polishing and silicone residues
- Paint shops friendly
- powerful degreasing without affecting the existing paint film / surface
- Compatible with all paint systems including the water-based
- For use, we recommend the very soft, turquoise microfiber cloth 40x40cm (item no. : 2000-940-40) or the purple microfiber cloth 40x60cm (item no.2000-940-60)

**Pouring tap**  
for 5 liter containers

- ▶ Item no. 2000-000-005
- ▶ PU: 1

matching:  
Microfiber cloth  
Item No. 2000-940-40



matching:  
Microfiber cloth  
Item No. 2000-940-60



**02 High gloss polish**  
Perfect gloss

- ▶ Item no. 2000-344-1
- ▶ Content: 1 litre
- ▶ Quantity per box: 6
- ▶ Item no. 2000-344-5
- ▶ Content: 5 litres
- ▶ PU: 1
- ▶ **Technical specifications**
- removes holograms
- leaves a long-lasting deep shine and protection
- does not contain any volatile silicone
- Processing by hand possible
- Rotary machines: 800 - 1,500 rpm
- Eccentric machines: 1,700 - 2,200 rpm



matching:  
Microfiber cloth  
Item No. 2000-745-40



matching:  
Microfiber cloth  
Item No. 2000-840-60



**Pouring tap**  
for 5 liter containers

- ▶ Item no. 2000-000-005
- ▶ PU: 1



**Push-pull closure**  
for 500ml and 1000ml bottles

- ▶ Item no. 2000-356-2
- ▶ PU: 1



**03 Waffle polishing sponge**  
for very easy removal, black

Item No.	Ø mm	PU
2000-354-75	75	4
2000-354-150	150	2



**04 Polishing sponge soft**  
slight removal, black

Item No.	Ø mm	PU
2000-353-75	75	4
2000-353-150	150	2



**05 Application sponge**  
Application sponge for hand processing

Item No.	Ø mm	PU
2000-209-130	130	1





01

**Quick seal**  
Speed Gloss Nano

- ▶ Item no. 2000-316-1
- ▶ Content: 1 litre
- ▶ Quantity per box: 6
  
- ▶ Item no. 2000-316-5
- ▶ Content: 5 litres
- ▶ PU: 1
  
- ▶ Technical specifications
- perfect gloss effect
- effortless, residue-free repolishing
- suitable for cleaning without water
- contains carnauba wax



**Pouring tap**  
for 5 liter containers

- ▶ Item no. 2000-000-005
- ▶ PU: 1



**Push-pull closure**  
for 500ml and 1000ml bottles

- ▶ Item no. 2000-356-2
- ▶ PU: 1



02

**Microfiber cloth**  
Gray

- ▶ Item no. 2000-745-40
- ▶ PU: 1
  
- ▶ Technical specifications
- extremely soft plush cloth
- Scratch-free polishing of polish residues
- Wash up to 40 ° C
- Tumble dry up to 30 ° C
- do not use plasticizers and bleach



03

**Microfiber cloth**  
medium high pile

- ▶ Item no. 2000-840-60
- ▶ PU: 1
  
- ▶ Technical specifications
- Dimensions: 40 x 60 cm
- medium deep pile
- very soft
- high quality
- washable up to 40 ° C
- not suitable for the dryer
- Do not use any softeners or bleach when washing!



04

**Application sponge**  
black

- ▶ Item no. 2000-209-130
- ▶ PU: 1
  
- ▶ Technical specifications
- ergonomic handle for easy and safe processing of:
- Wax sealer Speed-Wax (Item number 2000-330-1)
- Quick sealer Speed Gloss Nano (Art.-No. 2000-316)



05

**Long-term surface protection sealing**  
Pearl

- ▶ Item no. 2897-327
- ▶ Content: 500 ml
- ▶ Quantity per box: 12
  
- ▶ Item no. 2897-327-5
- ▶ Content: 5 litres
- ▶ PU: 1
  
- ▶ Technical specifications
- Surface protection sealing



**Pouring tap**  
for 5 liter containers

- ▶ Item no. 2000-000-005
- ▶ PU: 1

06

**Microfiber cloth**  
Gray

- ▶ Item no. 2000-745-40
- ▶ PU: 1
  
- ▶ Technical specifications
- extremely soft plush cloth
- Scratch-free polishing of polish residues
- Wash up to 40 ° C
- Tumble dry up to 30 ° C
- do not use plasticizers and bleach



07

**Microfiber cloth**  
medium high pile

- ▶ Item no. 2000-840-60
- ▶ PU: 1
  
- ▶ Technical specifications
- Dimensions: 40 x 60 cm
- medium deep pile
- very soft
- high quality
- washable up to 40 ° C
- not suitable for the dryer
- Do not use any softeners or bleach when washing!



01

**Carnauba wax sealant Premium Wax**

Premium Wax

- ▶ Item no. 2000-330-200
- ▶ Content: 200 ml
- ▶ Quantity per box: 12

▶ **Technical specifications**

- long-lasting sealing
- with maximum, high-purity Brazilian carnauba wax content
- can be processed excellently
- leaves a brilliant mirror shine with a lotus effect
- Processing can either be done with the hand application sponge (item no. 2000-209-130) or the waffle sponge (item no. 2000-354- ..) in conjunction with the eccentric polishing machine (item no. 8697-114 -13) at a speed of approx. 1700-2200 rpm
- maximum carnauba wax content (more than 40g carnauba on 200g wax)
- high-quality oils and natural raw materials support the protective and shine effect
- simple, effortless manual processing
- Top class car care wax produced by hand in small series



02

**Microfiber cloth**

Gray

- ▶ Item no. 2000-745-40
- ▶ PU: 1

▶ **Technical specifications**

- extremely soft plush cloth
- Scratch-free polishing of polish residues
- Wash up to 40 ° C
- Tumble dry up to 30 ° C
- do not use plasticizers and bleach



03

**Microfiber cloth**

medium high pile

- ▶ Item no. 2000-840-60
- ▶ PU: 1

▶ **Technical specifications**

- Dimensions: 40 x 60 cm
- medium deep pile
- very soft
- high quality
- washable up to 40 ° C
- not suitable for the dryer
- Do not use any softeners or bleach when washing!



04

**Waffle polishing sponge**

for very easy removal, black

Item No.	Ø mm	PU
2000-354-75	75	4
2000-354-150	150	2



05

**Polishing sponge soft**

slight removal, black

Item No.	Ø mm	PU
2000-353-75	75	4
2000-353-150	150	2



06

**Application sponge**

Application sponge for hand processing

Item No.	Ø mm	PU
2000-209-130	130	1





01

**Long-term sealing**  
Paint Guard

- ▶ Item no. 2000-331-500
- ▶ Content: 500 ml
- ▶ Quantity per box: 12



▶ **Technical specifications**

- Processing by hand
- extra UV protection for long-term preservation of the paint layer
- leaves a deep shine
- free of volatile silicones



**Push-pull closure**

for 500ml and 1000ml bottles

- ▶ Item no. 2000-356-2
- ▶ PU: 1



02

**Microfiber cloth**  
Gray

- ▶ Item no. 2000-745-40
- ▶ PU: 1

▶ **Technical specifications**

- extremely soft plush cloth
- Scratch-free polishing of polish residues
- Wash up to 40 ° C
- Tumble dry up to 30 ° C
- do not use plasticizers and bleach



03

**Microfiber cloth**  
medium high pile

- ▶ Item no. 2000-840-60
- ▶ PU: 1

▶ **Technical specifications**

- Dimensions: 40 x 60 cm
- medium deep pile
- very soft
- high quality
- washable up to 40 ° C
- not suitable for the dryer
- Do not use any softeners or bleach when washing!



04

**Application sponge**  
black

- ▶ Item no. 2000-209-130
- ▶ PU: 1

▶ **Technical specifications**

- ergonomic handle for easy and safe processing of:
- Wax sealer Speed-Wax (Item number 2000-330-1)
- Quick sealer Speed Gloss Nano (Art.-No. 2000-316)



05

**Ceramic sealant Ceramic Shield 9H Set**  
Ceramic Shield 9H Set

- ▶ Item no. 2000-333

▶ **Technical specifications**

- Ultimate sealing
- 9H protective layer for the paint
- Long-term protection up to 3 years
- hydrophobic and dirt-repellent
- increased service life of the paint
- 
- Content:
- 30ml ceramic-quartz long-term sealing
- 185ml Surface Control - highly active cleaner, degreaser and control spray (item no.2000-28-185)
- 1x pipette
- 1x application block
- 3x dust cloth, light blue 30x38cm
- 2x silk scarf 12x12cm
- 2x microfiber cloth, turquoise 40x40cm (Item No. 2000-940-40)
- 1 pair of disposable gloves
- Instructions for use



matching:  
Microfiber cloth  
Item No. 2000-940-60





01  
**Grinding-polishing-sealing**  
Compact

- ▶ Item no. 2000-335-1
- ▶ Content: 1 kg
- ▶ PU: 1

- ▶ Technical specifications
- fast and professional preparation of used vehicle paints
- Grinding, polishing and sealing in one step
- free of volatile silicones
- suitable for HS lacquers



02  
**Polishing sponge medium**  
medium removal, orange

Item No.	Ø mm	PU
2000-352-75	75	4
2000-352-150	150	2



03  
**Polishing sponge soft**  
slight removal, black

Item No.	Ø mm	PU
2000-353-75	75	4
2000-353-150	150	2



04  
**Waffle polishing sponge**  
for very easy removal, black

Item No.	Ø mm	PU
2000-354-75	75	4
2000-354-150	150	2



05  
**Application sponge**  
Application sponge for hand processing

Item No.	Ø mm	PU
2000-209-130	130	1





01

**Spider polishing sponge**

Color: blue with excenter

Item No.	Ø mm	PU
2000-355-150	150	2



02

**Polishing sponge medium**

medium removal, orange

Item No.	Ø mm	PU
2000-352-75	75	4
2000-352-150	150	2



03

**Polishing sponge medihard**

for scratch cut

Item No.	Ø mm	PU
2000-357-80	80	4
2000-357-150	150	2



04

**Polishing sponge hard**

high stock removal, yellow

Item No.	Ø mm	PU
2000-351-75	75	4
2000-351-150	150	2



05

**Lambskin**

Color white

Item No.	Ø mm	PU
2000-350-75	75	4
2000-350-150	150	2



06

**Polishing sponge soft**

slight removal, black

Item No.	Ø mm	PU
2000-353-75	75	4
2000-353-150	150	2



07

**Waffle polishing sponge**

for very easy removal, black

Item No.	Ø mm	PU
2000-354-75	75	4
2000-354-150	150	2



08

**Application sponge**

Application sponge for hand processing

Item No.	Ø mm	PU
2000-209-130	130	1



01

**Microfiber cloth**

seamless

▶ Item no. 2000-740-40

▶ PU: 1

▶ Technical specifications

- Dimensions: 40 x 40 cm
- deep pile
- rounded edges
- washable up to 40 ° C
- Suitable for tumble dryers up to 30 ° C
- Do not use any softeners or bleach when washing!



02

**Microfiber cloth**

standard

▶ Item no. 2000-640-40

▶ PU: 2

▶ Technical specifications

- Dimensions: 40 x 40 cm
- lint and dust free
- washable up to 40 ° C
- tumble dryer suitable up to 30 ° C



03

**Microfiber cloth**

Very soft

▶ Item no. 2000-940-40

▶ PU: 2

▶ Technical specifications

- very soft
- high quality
- lint-free cleaning
- Washable up to max. 60 ° C
- not suitable for the dryer
- Dimensions: 40x40cm
- 2 pieces per package

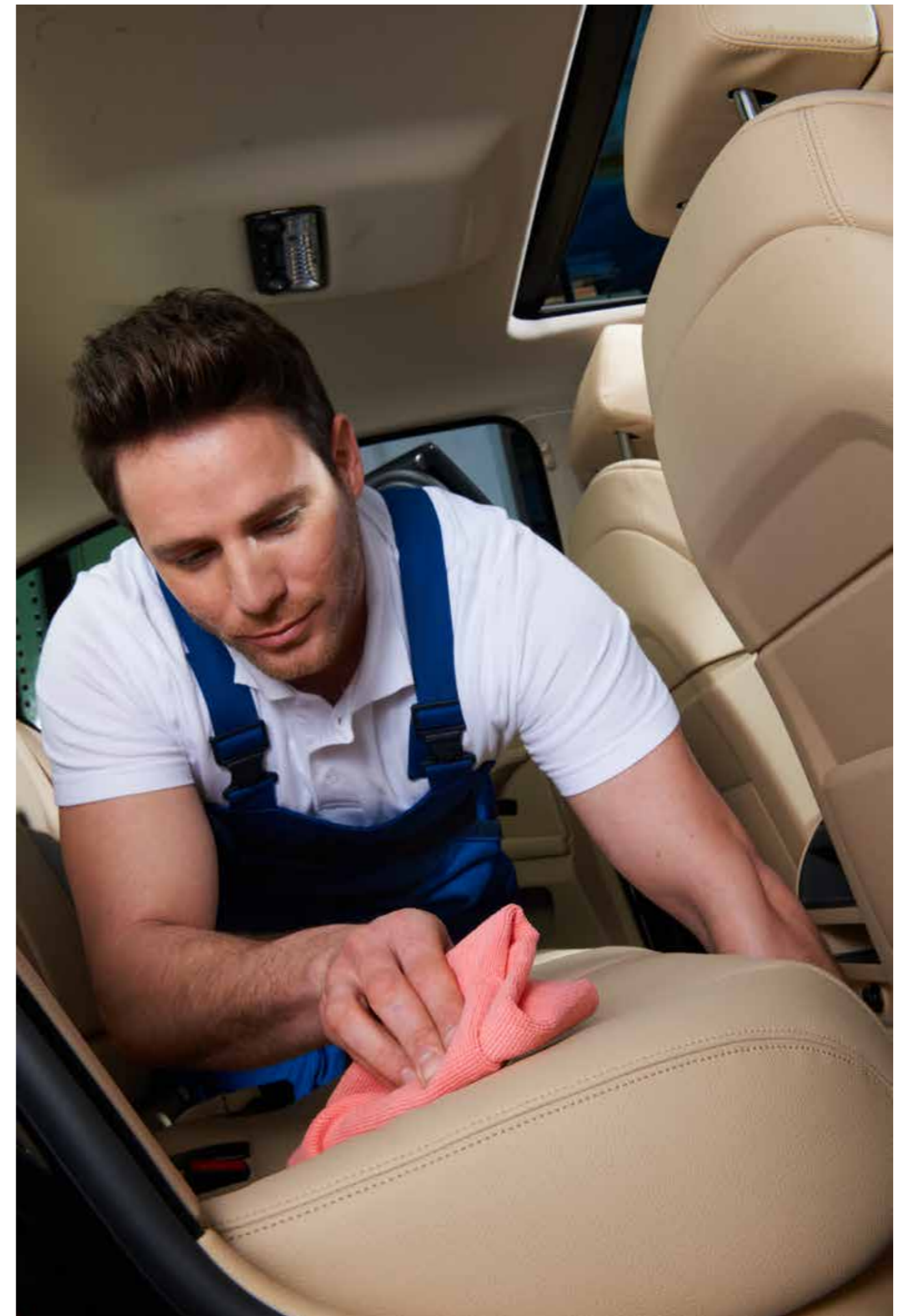





01  
**Microfiber cloth**  
Gray

- ▶ Item no. 2000-745-40
- ▶ PU: 1

- ▶ Technical specifications
- extremely soft plush cloth
- Scratch-free polishing of polish residues
- Wash up to 40 ° C
- Tumble dry up to 30 ° C
- do not use plasticizers and bleach



02  
**Microfiber cloth**  
medium high pile

- ▶ Item no. 2000-840-60
- ▶ PU: 1

- ▶ Technical specifications
- Dimensions: 40 x 60 cm
- medium deep pile
- very soft
- high quality
- washable up to 40 ° C
- not suitable for the dryer
- Do not use any softeners or bleach when washing!



03  
**Microfiber cloth**  
for lint-free cleaning

- ▶ Item no. 2000-940-60
- ▶ PU: 2

- ▶ Technical specifications
- high quality
- lint-free cleaning
- Washable up to max. 60 ° C
- purple
- not suitable for the dryer
- Dimensions: 40x60cm
- 2 pieces per package



04  
**Microfiber cloth King Screen**  
Microfiber cloth

- ▶ Item no. 2000-840-40
- ▶ PU: 2

- ▶ Technical specifications
- streak-free shine in one step
- reinforced weaving technique with flaky grain
- Can be used dry and wet
- lint free



05  
**Tornador® Towel**  
Drying cloth

- ▶ Item no. 2000-766-43
- ▶ PU: 1

- ▶ Technical specifications
- very supple
- washable up to 30 ° C
- resistant to most oils, fats and chemicals
- for gentle drying of all sensitive surfaces
- dries streak-free and lint-free





01

**Eccentric polishing machine**

Tornador Ø 150 mm

► Item no. 8697-114-13

► Technical specifications

- max. polishing pad Ø: 180 mm
- max. support pad Ø: 150 mm
- Speeds: 1700-4200 rpm
- Eccentric stroke: 21mm
- Power output: 900W
- 10 meters of cable
- stepless adjustable speed
- removable additional handle 240V / 50Hz
- Weight: 4.28 kg



02

**Velcro plate**

for eccentric polishing machine

► Item no. 8697-114-132

► Technical specifications

- Ø 150 mm



03

**Mini polishing machine**

incl. Velcro plate

► Item no. 8696-540-004

► Technical specifications

- Weight: 600 g
- Max. Speed: 5,500 rpm
- Adjustable speed: yes
- Vibrations: <math><2.5 \text{ m/s}^2</math>
- Air consumption: 84 l / min
- Sound power level: 89.4 dB
- Length: 130 mm
- Velcro plate diameter: approx. 75mm
- incl. plug nipple with 1/4 „male thread



04

**Velcro plate**

Replacement plate for mini polishing machine

Item No.	Ø mm
8696-540-050	50
8696-540-075	75





01

**3in1 Velcro polishing pad**

has an M14 thread mount

► Item no. 4666-075-150

► Technical specifications

- consists of three different sized Velcro plates: 75mm, 120mm and 145 mm
- No need to re-clamp Velcro discs in different sizes
- suitable for all of our polishing sponges and lambskins
- offers a high degree of flexibility
- has an M14 machine mount



02

**Velcro plate**

for polishing machine

► Technical specifications

- with Velcro attachment for polishing sponges
- M14 thread mount

Item No.	Ø
4666-075-1	75 mm
4666-150-1	150 mm



03

**Starter Set Paint Preparation**

► Item no. 2000-004

► Technical specifications

- 1x 2000-28-185 Surface Control Degreaser/Contr.Sp.185ML
- 1x 2000-341-500 Scratch Cut - highl. abrasive paper 500g/V6
- 1x 2000-343-500 Scratch Finish high gloss 500g/V6
- 1x 2000-352-150 Polishing sponge medium 150 mm orange
- 1x 2000-354-150 Waffle polishing sponge 150 mm Black
- 1x 2000-357-150 Polishing sponge Medihard 150 mm White
- 1x 2000-745-40 Premium microfibre cloth high pile. 40x40 cm
- 1x 2000-940-40 Microfibre cloth Turquoise 40x40 cm
- 1x 2000-940-60 Microfibre cloth Purple 40x60 cm 320G
- 1x 2897-327 Pearl - Long-life sealer 500 ml V12



01

**1K headlight primer**

1K primer

- ▶ Item no. 2800-790
- ▶ Content: Size 10
- ▶ Quantity per box: 6

▶ Technical specifications

- excellent adhesion properties
- high elasticity
- does not affect the light transmission
- Broad jet atomization (spray pattern analogous to the paint gun)
- constant atomizer pressure until the can is completely emptied
- professional result



02

**Abralon™ abrasives**

▶ Technical specifications

- Ø 150mm
- Grit 360
- unperforated
- extreme flexibility
- quickly creates a smooth, uniform surface finish, even on contours
- accelerates polishing operations

Item No.	Ø mm	Grit	PU
4587-500-75	77	500	1 /20
4587-600-75	77	600	1 /20
4587-100-075	77	1000	1 /20
4587-200-075	77	2000	1 /20
4587-300-075	77	3000	1 /20
4587-400-075	77	4000	1 /20



03

**Velcro discs**

Ø 150 mm, standard, 15 holes perforated

Item No.	Grit	PU
4515-040	40	50
4515-060	60	50
4515-080	80	100
4515-010-0	100	100
4515-012-0	120	100
4515-015-0	150	100
4515-018-0	180	100
4515-022-0	220	100
4515-024-0	240	100
4515-032-0	320	100
4515-040-0	400	100
4515-050-0	500	100



04

**NORTON ICE finish discs**

NORTON ICE

▶ Technical specifications

- less effort
- waterproof and washable
- reusable
- perfect finish
- water-absorbing foam pad adapts itself optimally to the surface with even pressure distribution
- consistent grinding result throughout the entire service life
- high surface quality and low roughness depths

Item No.	Grit	PU
4672-150-0	1500	12
4672-200-0	2000	12
4672-300-0	3000	12





01

**Non-woven cloth roll**

500 Shelter

- ▶ Item no. 7875-505
- ▶ PU: 2

▶ Technical specifications

- lint free
- Can be used wet and dry
- biodegradable
- Components: 55% wood flour - 45% polyester (without binding agent)
- Color turquoise
- resistant to solvents
- high absorption capacity
- is sold as a double role
- 500 breaks per roll
- Leaf height: 38 cm
- Sheet width: 30 cm



02

**Non-woven cleaning cloth**

perforated, 400 tear-offs

- ▶ Item no. 7875-5
- ▶ PU: 2

▶ Technical specifications

- very absorbent
- high cotton content
- wringable
- tearproof
- resistant to most solvents
- 2 rolls per packaging unit
- 400 wipes per roll
- 29 x 38 cm
- Perforation for easy tear-off
- textile wipes (70% cotton, 15% synthetic fibers, 15% PP)



03

**Non-woven cloth roll**

perforated, 400 tear-offs

- ▶ Item no. 7875-500
- ▶ PU: 1

▶ Technical specifications

- Color white
- extremely strong suction
- very wet, tear and abrasion resistant
- Washable and wringable
- solvent resistant
- silicone free
- food safe
- perforated
- 400 demolitions
- Roll length: 152m
- Dimensions: W29 cm x L38 cm



04

**Pulp roll**

2-ply, 750 tear-offs

- ▶ Item no. 7875-1
- ▶ PU: 2

▶ Technical specifications

- Roll length: 255 m
- Color white
- absorbent
- 2-ply
- Dimensions: 23.5 x 34 cm





01  
**Cleaning paper roll**  
2-ply, 1,000 tear-offs

- ▶ Technical specifications
- Roll Ø: 29cm
- colour: blue
- with embossing, fully glued



Item No.	Dimensions	execution	PU
7875-502	22 x 36	22 x 36 cm embossed, fully coated	2
7875-503	36 x 38	36 x 38 cm embossed, fully coated	2
7875-504	38 x 36	36,5 x 36,5 cm	2

02  
**Wall holder**  
max.roll width 75 cm

▶ Item no. 7875-901

- ▶ Product description
- for 3 compact rolls, max.roll width 75 cm
- Slip covers, compact rolls and garbage bags
- H x W x D: 70 x 76 x 24 cm

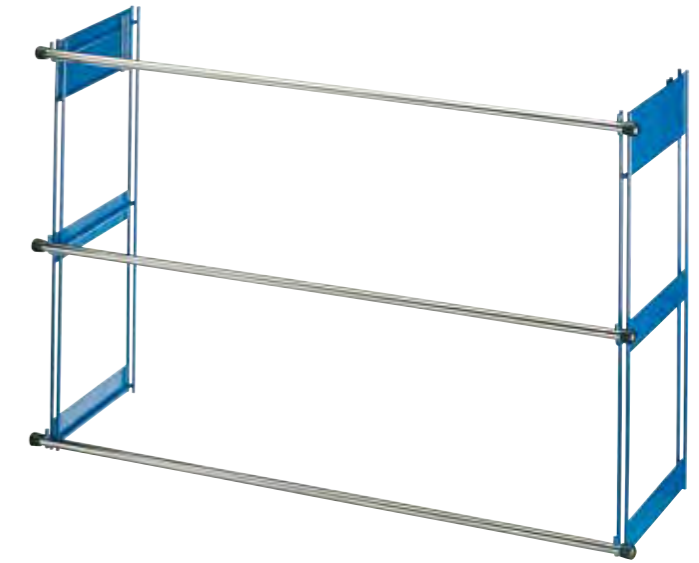

03  
**Stand for cleaning paper**  
for cleaning paper

▶ Item no. 7875-3

- ▶ Product description
- max.roll width 40 cm



04  
**Wall holder**  
max.roll width 40 cm

▶ Item no. 7875-2

- ▶ Product description
- max.roll width 40 cm





01

**Tar remover**

Power-Star Ultra

- ▶ Item no. 2000-04
- ▶ Content: 5 litres
- ▶ PU: 1
- ▶ Item no. 2000-000-005
- ▶ Pouring tap
- ▶ for 5 liter containers

▶ Technical specifications

- dissolves road tar
- removes new car stickers
- removes adhesive and sealing residues from all exterior plastics, lacquer surfaces and glass



02

**Rust film remover**

Mega-Star

- ▶ Item no. 2000-10
- ▶ Content: 5 litres
- ▶ PU: 1
- ▶ Item no. 2000-000-005
- ▶ Pouring tap
- ▶ for 5 liter containers

▶ Technical specifications

- Cleaner for heavy inorganic soiling such as concrete residues
- Effortlessly removes stubborn road dirt, brake dust, lime, oily incrustations, surface rust and flash rust
- also ideal for cleaning rims
- AOX-free?
- Mixing ratio: 1:10



03

**Universal cleaner, power cleaner**

Uni-Star

- ▶ Item no. 2000-02
- ▶ Content: 5 litres
- ▶ PU: 1
- ▶ Item no. 2000-000-005
- ▶ Pouring tap
- ▶ for 5 liter containers

- ▶ Item no. 2000-02-30
- ▶ Content: 30 litre
- ▶ PU: 1
- ▶ Item no. 2000-000-030
- ▶ Pouring tap
- ▶ for 30 liter containers

▶ Technical specifications

- Universally applicable indoors and outdoors
- AOX-free
- removes all types of stubborn road dirt
- effortlessly removes oils, fats, nicotine and insects
- leaves no marks or matt surfaces
- gentle on paint, decorative strips and lettering
- alkaline
- Basis: nonionic surfactants, alkalis, complexing agents
- Mixing ratio:
- High pressure cleaner: 1: 1 to max. 1: 5
- Low pressure / manual processing: 1: 1 to max. 1:10
- Density: approx. 1.02 g / ml
- PH value: approx. 12.8





01

**Power cleaner, degreaser, universal cleaner**

All Star Protect

- ▶ Item no. 2000-318-5
- ▶ Content: 5 litres
- ▶ PU: 1
- ▶ Item no. 2000-000-005
- ▶ Pouring tap
- ▶ for 5 liter containers
- ▶ Item no. 2000-318-30
- ▶ Content: 30 litre
- ▶ PU: 1
- ▶ Technical specifications
- universally applicable
- AOX free
- removes stubborn road dirt, oils, greases, nicotine and insects
- Aluminum safe (tested on the most common vehicles)
- free from solvents, silicates and phosphates
- gentle on paint, rubber parts and lettering
- PH value 10
- low in color and odor
- Mixing ratio:
- High pressure cleaner 1: 5 to 1:20 (max. 50 ° C)
- Low pressure / manual processing 1:10 to max. 1:40



03

**PH neutral intensive cleaner**

7Clean

- ▶ Item no. 2000-777-05
- ▶ Content: Aquano
- ▶ Quantity per box: 12
- ▶ Item no. 2000-777-5
- ▶ Content: Uni-Star
- ▶ PU: 1
- ▶ Item no. 2000-000-005
- ▶ Pouring tap
- ▶ for 5 liter containers
- ▶ Technical specifications
- highly effective intensive cleaner for inside and outside
- ready to use
- powerful, easy cleaning
- for all interior surfaces (fabric covers, carpets, plastic cladding, rubber and metal moldings)
- removes dried-on dirt (e.g. insect residues) on paint, plastic and glass
- PH-level neutral



02

**Power cleaner concentrate, universal cleaner**

All-star

- ▶ Item no. 2000-312-5
- ▶ Content: 5 litres
- ▶ PU: 1
- ▶ Item no. 2000-000-005
- ▶ Pouring tap
- ▶ for 5 liter containers
- ▶ Item no. 2000-312-30
- ▶ Content: 30 litre
- ▶ PU: 1
- ▶ Technical specifications
- universally applicable
- AOX-free
- removes all types of stubborn road dirt
- effortlessly removes oils, fats, nicotine and insects
- gentle on paint, decorative strips and lettering
- especially for high pressure cleaners
- can be used warm and cold?
- Mixing ratio:
- High pressure cleaner: 1: 1 to max. 1: 6
- Low pressure / manual processing: 1: 1 to max. 1:25



04

**Cleaning and care spray**

Perfect matte

- ▶ Item no. 2000-06
- ▶ Content: 500 ml
- ▶ Quantity per box: 6
- ▶ Technical specifications
- for matt surfaces
- for cleaning and polishing paint, plastic, laminate and glass
- does not change the gloss level of the treated surface
- paintable spray
- removes fingerprints from all hard surfaces





01

**Tarpaulin cleaner concentrate**

Cover star

- ▶ Item no. 2000-313-30 ▶ Item no. 2000-000-030
- ▶ Content: 30 litre ▶ Pouring tap
- ▶ PU: 1 ▶ for 30 liter containers

▶ Technical specifications

- Miscible up to 1: 100 with water
- suitable for use with high-pressure cleaners
- does not contain any halogenated hydrocarbons
- free of adsorbable organic halogen compounds (AOX)
- biodegradable



03

**Active foam cleaner**

Active care

- ▶ Item no. 2000-401-30 ▶ Item no. 2000-000-030
- ▶ Content: 30 litre ▶ Pouring tap
- ▶ PU: 1 ▶ for 30 liter containers

▶ Technical specifications

- for soaking and cleaning heavy soiling and chemical prewash
- in the car wash: pure
- 1: 1 via dosing pump (setting 8-20ml)



02

**Insect remover silicone-free**

Insect-Star Extreme

- ▶ Item no. 2000-322-5 ▶ Item no. 2000-000-005
- ▶ Content: 5 litres ▶ Pouring tap
- ▶ PU: 1 ▶ for 5 liter containers

- ▶ Item no. 2000-322-30 ▶ Item no. 2000-322-30
- ▶ Content: 30 litre ▶ Pouring tap
- ▶ PU: 1 ▶ for 30 liter containers

▶ Technical specifications

- Special cleaner for removing dried-on insect residues
- silicone free
- applicable on painted surfaces, glass, plastic and alkali-resistant surfaces
- can be used undiluted or mixed with up to 3 parts water
- Apply evenly to the surface to be cleaned



04

**Drying accelerator**

Speed-dry

- ▶ Item no. 2000-404-30 ▶ Item no. 2000-000-030
- ▶ Content: 30 litre ▶ Pouring tap
- ▶ PU: 1 ▶ for 30 liter containers

▶ Technical specifications

- to aid drying by tearing open the water film
- Car wash: pure
- 1: 1 via the dosing pump (setting 8-20ml)



01

**Car shampoo**

Wash

- ▶ Item no. 2000-321-5 ▶ Item no. 2000-000-005
- ▶ Content: 5 litres ▶ Pouring tap
- ▶ PU: 1 ▶ for 5 liter containers

- ▶ Item no. 2000-300-30 ▶ Item no. 2000-322-30
- ▶ Content: 30 litre ▶ Pouring tap
- ▶ PU: 1 ▶ for 30 liter containers

▶ Technical specifications

- Shampoo concentrate? (Mixing ratio 1: 100)
- pH 7.7
- quickly removes dirt and road grime
- leaves a shiny, streak-free surface



03

**Car wash shampoo**

Power Wash

- ▶ Item no. 2000-402-30 ▶ Item no. 2000-000-030
- ▶ Content: 30 litre ▶ Pouring tap
- ▶ PU: 1 ▶ for 30 liter containers

▶ Technical specifications

- for cleaning vehicles and creating a lubricating film
- in the car wash: pure
- 1: 1 via the dosing pump (setting 8-15 ml)
- machine: diluted up to 1: 500? (depending on the degree of soiling)
- manual: diluted up to 1:50? (depending on soiling)



02

**Gloss shampoo**

Wash

- ▶ Item no. 2000-300-5 ▶ Item no. 2000-000-005
- ▶ Content: 5 litres ▶ Pouring tap
- ▶ PU: 1 ▶ for 5 liter containers

- ▶ Item no. 2000-300-30 ▶ Item no. 2000-322-30
- ▶ Content: 30 litre ▶ Pouring tap
- ▶ PU: 1 ▶ for 30 liter containers

▶ Technical specifications

- Concentrate with wax
- with a shiny beading effect
- silicone free
- AOX-free
- with wax
- quickly removes road debris and traffic deposits
- cleans and preserves the paint in a simple operation
- optimal mixing ratio: 15ml to 10 liters of warm water



04

**Special washing shampoo for commercial vehicles**

Truck Wash

- ▶ Item no. 2000-408-200
- ▶ Content: Truck Wash
- ▶ PU: 1

▶ Technical specifications

- for manual and machine processing
- warm





01

**Flocculants**

Fluid check

- ▶ Item no. 2000-405-30
- ▶ Content: 30 kg
- ▶ PU: 1
  
- ▶ Item no. 2000-000-030
- ▶ Pouring tap
- ▶ for 30 liter containers
  
- ▶ Technical specifications
  - destabilizes colloids and emulsions
  - binds hydrocarbons, heavy metals, phosphates, surfactants and dirt particles
  - particularly suitable for use in gravel filter systems
  - Adjust the pH of the water to 6.5-7.5
  - approx. 50-1,000ml / m<sup>3</sup> water depending on the degree of pollution
  - Aluminum hydroxide chloride (monomeric) according to EN 881



02

**PH regulator**

PH check

- ▶ Item no. 2000-406-30
- ▶ Content: 35 kg
- ▶ PU: 1
  
- ▶ Item no. 2000-000-030
- ▶ Pouring tap
- ▶ for 30 liter containers
  
- ▶ Technical specifications
  - is used for pH control in systems for emulsion splitting, wastewater treatment, etc.
  - based on sodium hydroxide
  - pH-Check is dosed into the waste water via a dosing pump with pH value control



03

**Spray wax and gloss dryer**

Deep Shine

- ▶ Item no. 2000-403-30
- ▶ Content: 30 litre
- ▶ PU: 1
  
- ▶ Item no. 2000-000-030
- ▶ Pouring tap
- ▶ for 30 liter containers
  
- ▶ Technical specifications
  - versatile
  - silicone free
  - Hand pump: 1:50 - short-term sealing
  - Hand pump: 1:20 long-term preservative
  - Washing system: 1: 500 - gloss dryer





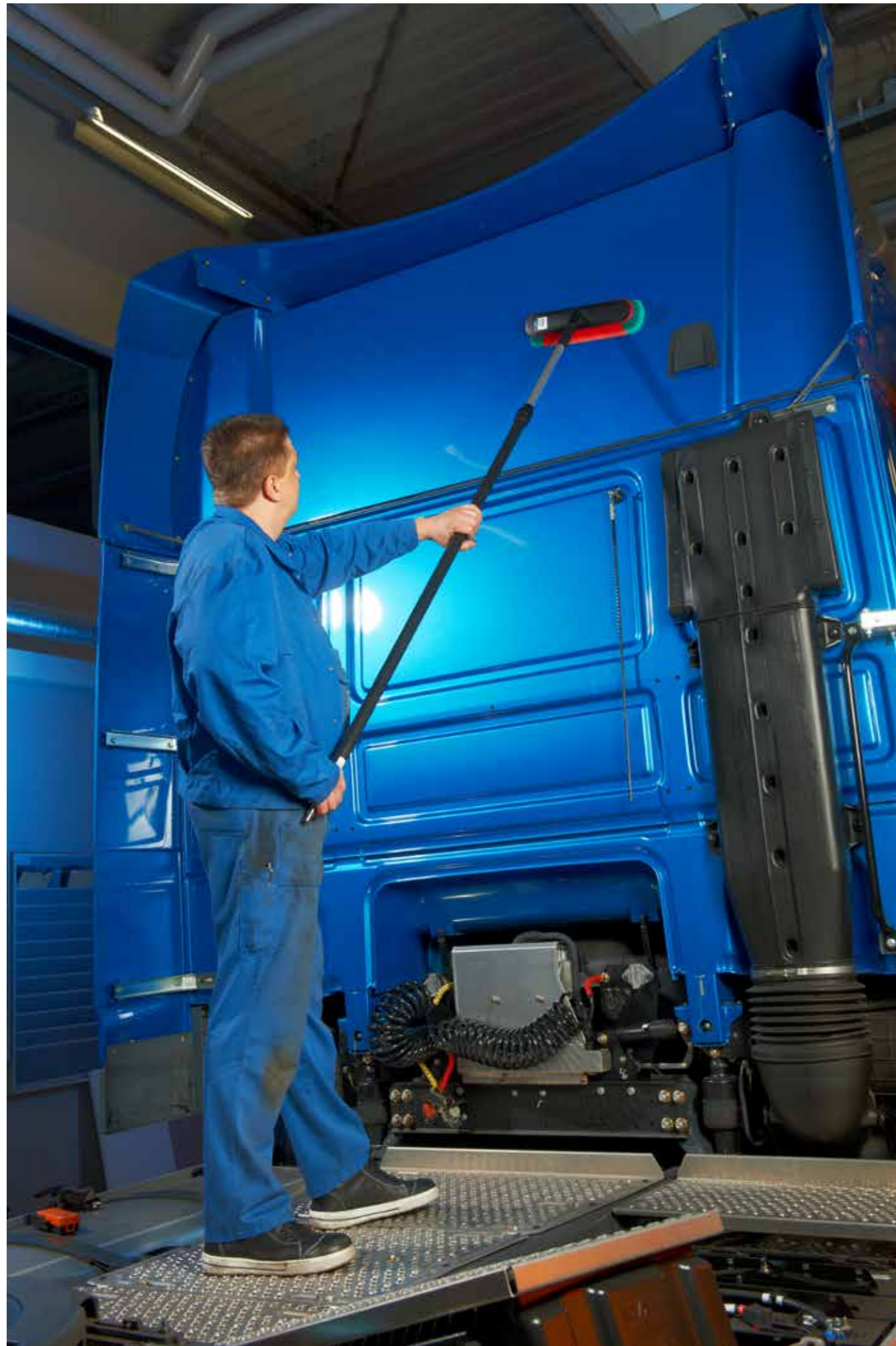

01

**Washing brush**  
with water flow

▶ Item no. 2000-810-4

## ▶ Technical specifications

- Brush type: soft / split
- Length: 400 mm
- Width: 90mm
- Filament: 50 mm
- Material: PP / PBT
- Temperature resistance: 50 ° C



02

**Washing brush**  
with water flow

▶ Item no. 2000-810-3

## ▶ Technical specifications

- Brush type: soft / split
- Dimensions: 130mm x 260mm x 110mm
- Filament: 50mm
- Material: PP / PBT
- Temperature resistance: 50 ° C



03

**Rim brush**  
with water flow

▶ Item no. 2000-810-9

## ▶ Technical specifications

- Filament description: soft / split
- Filament length: 50 mm
- Height: 105 mm
- Length: 240 mm
- Width: 150mm
- Material: PP, PBT
- Max. Usage temperature: 50 ° Celsius





01

**Telescopic handle**

without water flow, 1590 - 2800 mm

- ▶ Item no. 2000-810-10
- ▶ Technical specifications
  - Diameter 31 mm
  - Height 45 mm
  - Length 1590 mm
  - Max. Length 2800 mm
  - Width 45 mm
  - Material aluminum, polypropylene
  - Max. Usage temperature 50 ° Celsius

02

**Telescopic handle**

With water throughput, 1600 - 2900 mm

- ▶ Item no. 2000-810-6
- ▶ Technical specifications
  - Connection: 1/2 „hose connection (Euro profile / Hozelock, Gardena)
  - Dimensions (HxWxD): 34mm x 1600mm 2900mm
  - Material: aluminum / PP
  - Temperature: 50 ° C
  - Pressure load: up to 6 bar

03

**Processing stalk**

without water flow, 1500 mm

- ▶ Item no. 2000-810-5
- ▶ Technical specifications
  - Dimensions: 31mm x 1500mm
  - Material: aluminum / PP
  - Temperature: 50 ° C



01                      02                      03

04

**Water squeegee**

with stem connection on the handle

- ▶ Item no. 2000-810-1
- ▶ Technical specifications
  - Dimensions (HxWxD): 50mm x 350mm 220mm
  - Material: POM / rubber
  - Temperature resistance: 100 ° C



05

**Water squeegee**

with stem connection on the handle

- ▶ Item no. 2000-810-2
- ▶ Technical specifications
  - Dimensions (HxWxD): 50mm x 450mm 220mm
  - Material: POM / rubber
  - Temperature resistance: 100 ° C



06

**Workshop broom**

hard

- ▶ Item no. 2000-810-11
- ▶ Product description
  - for sweeping wet and oily waste
  - Width: 440 mm
  - Body made of wood with a socket for handles with screw thread
  - with hard PVC bristles



07

**Bottom scraper**

black

- ▶ Item no. 2000-810-12
- ▶ Product description
  - Width: 600 mm
  - is great for removing water and oil
  - made of black polypropylene with an oil-resistant sheet made of cellular rubber



01

**Washing brush**

- ▶ Item no. 2000-820-1
- ▶ Technical specifications
  - Rubber protection on the brush body
  - sprung hair that does not scratch the paintwork
  - Width: 25 cm
  - long lifetime
  - thick trimmings of hair
  - Polypropylene
  - Telescopic handles also available (Item No. 2000-820-4 and 5)



02

**Wash brush for trucks**

- ▶ Item no. 2000-820-3
- ▶ Technical specifications
  - sprung hair that does not scratch the paintwork
  - long lifetime
  - thick trimmings of hair
  - Polypropylene
  - Width: 35 cm
  - Telescopic handle also available (Item No. 2000-820-9)



03

**Wash brush inclined at 30 °**

- ▶ Item no. 2000-820-2
- ▶ Technical specifications
  - Angle brush body
  - sprung hair that does not scratch the paintwork
  - excellent acid resistance
  - Maximum water temperature: 60 ° C
  - Width: 25 cm
  - long lifetime
  - thick trimmings of hair
  - Polypropylene
  - Telescopic handles also available (Item No. 2000-820-4 and 5)



04

**Telescopic handle**

2 x 1.50 m black, aluminum

- ▶ Item no. 2000-820-4
- ▶ Technical specifications
  - metal connection tip with wire
  - Lower part: fiberglass
  - Upper part: aluminum.
  - very solid execution
  - suitable for washing brushes 25 cm (item no.2000-820-1 and 2)



05

**Telescopic handle with water flow**

2 x 1.50 m

- ▶ Item no. 2000-820-5
- ▶ Technical specifications
  - metal connection tip with wire
  - Lower part: fiberglass
  - Upper part: aluminum
  - very solid execution
  - with on / off tap
  - with water flow
  - suitable for washing brushes 25 cm (item no.2000-820-1 and 2)



06

**Telescopic handle**

- ▶ Item no. 2000-820-9
- ▶ Technical specifications
  - aluminum
  - conical tip
  - 2 x 1.5 m
  - suitable for washing brush 35 cm (item no.2000-820-3)





01

**Hand washing brush**

- ▶ Item no. 2000-820-6
- ▶ Technical specifications
  - sprung hair that does not scratch the paintwork
  - long lifetime
  - thick trimmings of hair
  - Polypropylene



02

**Rim brush**

soft for aluminum and chrome rims

- ▶ Item no. 2000-810-8
- ▶ Technical specifications
  - Filament description: soft
  - Filament length: 40 mm
  - Color: Black
  - Diameter: 65 mm
  - Length: 330 mm
  - Material: PP, hair / PP
  - Max. Usage temperature: 60 ° Celsius



03

**Rim brush**

- ▶ Item no. 2000-820-7
- ▶ Technical specifications
  - long lifetime
  - thick trimmings of hair
  - Polypropylene
  - especially for rims



04

**Silicone water squeegee**

- ▶ Item no. 2000-810-30
- ▶ Technical specifications
  - ergonomically shaped water squeegee
  - with a 30 cm wide, very flexible soft silicone lip
  - usable on both sides
  - has a coarse thread connection for a telescopic handle (the thread is not compatible with the standard processing handles)



05

**Handle holder system**

with 3 clamps

- ▶ Item no. 2000-820-8
- ▶ Product description
  - Stainless steel holder
  - for better hygiene
  - for three handles ø 9 to 35 mm







01  
**Car sponge**  
Hydro

- ▶ Item no. 2000-602-1
- ▶ Size: 195 x 120 x 70 mm



02  
**Car sponge**  
pressed viscose sponge

- ▶ Item no. 2000-604
- ▶ Size: 130 x 90 x 10 mm

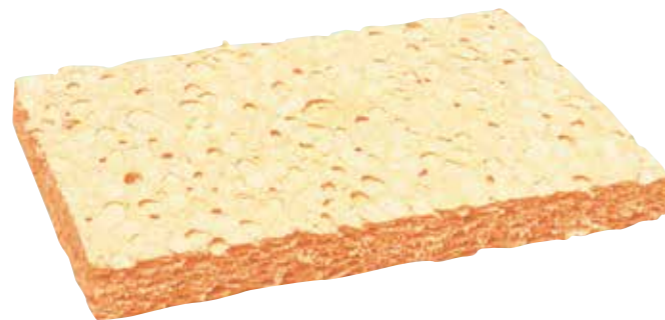

03  
**Universal sponge**  
Classic

- ▶ Item no. 2000-602
- ▶ Size: 180 x 120 x 65 mm



04  
**Insect sponge**  
extra strong

- ▶ Item no. 2000-601
- ▶ Size: 110 x 70 x 40 mm



05  
**Rim sponge**

- ▶ Item no. 2000-603
- ▶ Size: 165 x 105 x 53 mm



06  
**brush**  
with bow handle and scraping edge

- ▶ Item no. 2000-105
- ▶ Technical specifications
- Length: 160 mm
- Bristle length: 25 mm



07  
**Brush - animal hair brush**  
with V-bristles made of rubber

- ▶ Item no. 2000-107
- ▶ Technical specifications
- The handle can be swiveled by 90 ° and makes it easier to work at an angle
- with rubber lip for pulling off panes in water and snow





01

**Aluminum rim cleaner**

Rimol

- ▶ Item no. 2897-320-1
- ▶ Content: 500 ml
- ▶ Quantity per box: 6

▶ Technical specifications

- acidic
- effortlessly removes stubborn dirt (burnt-in brake dust, rust film, rubber abrasion, heavy oil encrustations, road dirt, etc.)



02

**Acid-free intensive aluminum rim cleaner**

Rimol gold Protect

- ▶ Item no. 2897-328-500
- ▶ Content: 500 ml
- ▶ Quantity per box: 12



- |                        |                           |
|------------------------|---------------------------|
| ▶ Item no. 2897-328-5  | ▶ Item no. 2000-000-005   |
| ▶ Content: 5 litres    | ▶ Pouring tap             |
| ▶ PU: 1                | ▶ for 5 liter containers  |
| ▶ Item no. 2897-328-30 | ▶ Item no. 2000-322-30    |
| ▶ Content: 30 litres   | ▶ Pouring tap             |
| ▶ PU: 1                | ▶ for 30 liter containers |

▶ Technical specifications

- acid free
- consists of 70% renewable raw materials, therefore environmentally friendly
- does not contain any substances hazardous to health when ventilated
- gel-like viscosity
- not poisonous
- not corrosive to the skin
- gentle cleaning power



03

**Special aluminum rim cleaner**

Rimol professional

- |                       |                          |
|-----------------------|--------------------------|
| ▶ Item no. 2897-321-5 | ▶ Item no. 2000-000-005  |
| ▶ Content: 5 litres   | ▶ Pouring tap            |
| ▶ PU: 1               | ▶ for 5 liter containers |

- |                        |                           |
|------------------------|---------------------------|
| ▶ Item no. 2897-321-30 | ▶ Item no. 2000-322-30    |
| ▶ Content: 30 litre    | ▶ Pouring tap             |
| ▶ PU: 1                | ▶ for 30 liter containers |

▶ Technical specifications

- acidic
- effortlessly removes stubborn dirt such as:
- Burned-in brake dust
- Rust film
- Rubber abrasion
- strong oil incrustations
- Street dirt
- Surface rust
- PH value: 1







**01 Engine compartment preservation**  
Motor fit

- ▶ Item no. 2000-307-1
- ▶ Inhalt: 1 litre
- ▶ Quantity per box: 6
- ▶ Item no. 2000-802-1
- ▶ Hand sprayer
- ▶ for 1 liter container
- ▶ Item no. 2000-307-5
- ▶ Inhalt: 5 litres
- ▶ PU: 1
- ▶ Item no. 2000-000-005
- ▶ Pouring tap
- ▶ for 5 liter containers
- ▶ Item no. 2000-307-30
- ▶ Inhalt: 30 litre
- ▶ PU: 1
- ▶ Item no. 2000-322-30
- ▶ Pouring tap
- ▶ for 30 liter containers
- ▶ Technical specifications
- high gloss
- displacing water
- contains silicone
- does not contain aromatic solvents
- protects electronic components



**02 Interior intensive cleaner**  
Interno Protect

- ▶ Item no. 2000-05
- ▶ Content: 500 ml
- ▶ Quantity per box: 12
- ▶ Item no. 2000-05-5
- ▶ Inhalt: 5 litres
- ▶ PU: 1



- ▶ Item no. 2000-000-005
- ▶ Pouring tap
- ▶ for 5 liter containers
- ▶ Technical specifications
- cares for hard and soft surfaces such as plastic, vinyl, chrome, sealing and door sill trims, car leather, upholstery and carpets
- Leaves a matt finish and a pleasantly fresh scent on plastic surfaces
- acid and silicone free
- does not contain hydrocarbon solvents
- not suitable for suede and alcantara
- ready to use







**01 Plastic and rubber care**  
All Plast

- ▶ Item no. 2000-370-500
- ▶ Inhalt: 500 ml
- ▶ Quantity per box: 12

- ▶ Item no. 2000-370-5
- ▶ Inhalt: 5 Liter
- ▶ PU: 1
- ▶ Item no. 2000-000-005
- ▶ Pouring tap
- ▶ for 5 liter containers

- ▶ **Technical specifications**
- versatile water-based care
- Care for tires, exterior plastics, rubber linings, seals, plastic parts in the engine compartment and rubber hoses
- leaves a deep black matt finish
- can be applied to wet or dry tires
- durable
- contains silicone
- The use of rubber seals in winter makes it easier to open doors in the cold season.



**02 Plastic care**  
Outplast

- ▶ Item no. 2000-319-500
- ▶ Content: 500 ml
- ▶ Quantity per box: 12

- ▶ **Technical specifications**
- gives long-lasting shine
- excellent surface protection against environmental influences
- silicone free
- not suitable for plastic interior parts and painted plastics

**03 Plastic painters**  
Plast-PT

- ▶ Item no. 2897-041
- ▶ Content: 75 ml
- ▶ Quantity per box: 12

- ▶ **Technical specifications**
- resistant to car washes, high pressure cleaners and solvents
- covers permanently
- including sponge

**04 Rubber care stick**  
Rubber Fit

- ▶ Item no. 2897-335-75
- ▶ Content: 75 ml
- ▶ Quantity per box: 12

- ▶ **Technical specifications**
- silicone-free
- resistant to splashes, salt water, alkalis and acids
- biodegradable
- contains natural waxes and caring additives
- Treated rubber parts remain soft and supple, which prevents cracks from forming
- Paint and chrome parts are not damaged by the active ingredient
- its water-repellent properties prevent rubber seals from freezing in winter



01

**Cockpit care spray silicone and solvent free**

New Look Protect

- ▶ Item no. 2897-337-1
- ▶ Content: 400 ml
- ▶ Quantity per box: 12



▶ **Technical specifications**

- silicone and solvent free
- binds fine dust
- antistatic
- leaves a semi-gloss finish
- leaves a neutral scent
- Cleaning and care for the dashboard, armrests, floor mats, shelves, consoles



02

**Interior cleaner**

Crystal Ultra

- ▶ Item no. 2897-306
- ▶ Content: 400 ml
- ▶ Quantity per box: 6

▶ **Technical specifications**

- improved recipe increases the cleaning and shine effect by up to 30%
- Use in the cockpit, on door panels, floor mats and seats (with the exception of displays and speedometers)
- dissolves fat residues
- leaves a pleasant new car smell
- antistatic against dust



03

**Universal foam cleaner**

Multin

- ▶ Item no. 2897-342
- ▶ Content: 600 ml
- ▶ Quantity per box: 12

▶ **Technical specifications**

- active foam
- cleans and degreases
- high dissolving power
- Leaves no residue
- Color: white foam



04

**Upholstery cleaner**

Velvet

- ▶ Item no. 2897-307
- ▶ Content: 400 ml
- ▶ Quantity per box: 12

▶ **Technical specifications**

- cleans and maintains upholstery, carpets and headliners
- dissolves fat residues
- leaves a pleasant scent
- works without suction





01

**Intensive window cleaner**  
topaz

- ▶ Item no. 2897-310
- ▶ Content: 400 ml
- ▶ Quantity per box: 24
  
- ▶ Item no. 2000-03
- ▶ Content: 5 litres Concentrate
- ▶ PU: 1

- ▶ Technical specifications
- silicone free
- also suitable for polycarbonate glass
- does not attack surfaces
- Foam formation only after the surface has been wetted with the material



**Pouring tap**

- ▶ Item no. 2000-000-005
- ▶ for 5 liter containers
- ▶ PU: 1



02

**High-tech special cleaner**  
Terpanol Power

- ▶ Item no. 2897-323
- ▶ Content: Starter Set
- ▶ Quantity per box: 12

- ▶ Technical specifications
- contains orange terpenes from 100% renewable raw materials
- optimally removes adhesive residues, oils, fats, waxes, waterproof edging traces, graffiti
- stronger loosening force of the respective dirt
- Dissolve after a very short time (approx. 20 seconds)



03

**Glass cleaner**  
Stries Protect

- ▶ Item no. 2897-340
- ▶ Content: Aquano
- ▶ Quantity per box: 12

- ▶ Item no. 2897-340-5
- ▶ Content: Uni-Star
- ▶ PU: 1

- ▶ Item no. 2897-340-30
- ▶ Content: 30 liters
- ▶ PU: 1

- ▶ Technical specifications
- Leaves behind clear, shiny, streak-free and clean glass surfaces
- removes dirt, stains, fingerprints, grease, nicotine, flies, etc.
- can be used on glass and polycarbonate glass
- silicone and ammonia free
- has no abrasives



04

**Pouring tap**

- ▶ Item no. 2000-000-005
- ▶ for 5 liter containers
- ▶ PU: 1

- ▶ Item no. 2000-000-030
- ▶ for 30 litre container
- ▶ PU: 1

05

**TFT and LCD display foam cleaner**  
Vista

- ▶ Item no. 2897-308
- ▶ Content: 100 ml
- ▶ Quantity per box: 12

- ▶ Technical specifications
- Special foam cleaner with a fresh citrus note
- efficient application
- Cleaning foam remains well in place
- works well even on vertical surfaces
- Alcohol-free and free of abrasives







01

**Leather care**

Ledanol

- ▶ Item no. 2000-310-1
- ▶ Content: 1 litre
- ▶ Quantity per box: 6
  
- ▶ Technical specifications
- cares for and protects leather
- solvent-free
- do not use on suede or similar surfaces



02

**Fresh fragrance odor destroyer**

Aerofit Plus

- ▶ Item no. 2000-309-2
- ▶ Content: 1 litre
- ▶ Quantity per box: 6
  
- ▶ Item no. 2000-802-1
- ▶ Hand sprayer
- ▶ for 1 liter container
  
- ▶ Technical specifications
- Can be used on all known fabric substrates in vehicle interiors and in ventilation shafts without sensors
- effectively and sustainably neutralizes all unpleasant odors such as nicotine
- solvent-free
- can be processed with a conventional spray bottle or a pressure pump spray bottle
- can also be processed very easily in a wet vacuum cleaner or nebuliser
- silicone free





01  
**Raspberry scented odor eliminator and air freshener**  
 Aerofit Power

- ▶ Item no. 2000-309-400
- ▶ Content: 400 ml
- ▶ PU: 12

- ▶ Technical specifications
- eliminates odors immediately and refreshes the room climate
- long-lasting and economical
- a high pressure system with an extremely concentrated active ingredient
- one puff is sufficient for a large area
- with raspberry scent

02  
**Coolwater scent odor eliminator and air freshener**  
 Aerofit Fresh Power

- ▶ Item no. 2000-309-410
- ▶ Content: 400 ml
- ▶ PU: 12

- ▶ Technical specifications
- eliminates odors immediately and refreshes the room climate
- long-lasting and economical
- a high pressure system with an extremely concentrated active ingredient
- one puff is sufficient for a large area
- with coolwater scent

03  
**Vanilla fragrance odor eliminator and air freshener**  
 Aerofit Vanille Power

- ▶ Item no. 2000-309-420
- ▶ Content: Starter Set
- ▶ PU: 12

- ▶ Technical specifications
- eliminates odors immediately and refreshes the room climate
- long-lasting and economical
- a high pressure system with an extremely concentrated active ingredient
- one puff is sufficient for a large area
- with vanilla scent

04  
**Lemon scent odor eliminator and air freshener**  
 Aerofit Fresh

- ▶ Item no. 2000-309-600
- ▶ Content: 600 ml
- ▶ PU: 12

- ▶ Technical specifications
- effective quickly
- does not leave any stains
- biological fragrance
- eliminates bad smells
- without heavy metals
- simple application
- very economical
- with citrus scent







01  
„Preparation“ starter set  
6 pieces

► Item no. 2897-000-004

- 1x Aerofit Power - odor eliminator 400ml (Art. 2000-309-400)
- 1x Topas - window cleaner 400ml (Art. 2897-310)
- 1x New Wheel Extreme - silicone tire care product 400ml (Art. 2897-338-400)
- 1x Terpanol Power - high-tech special cleaner 400ml (Art. 2897-323)
- 1x Velvet - upholstery cleaner 400ml (Art. 2897-307)
- 1x Crystal Ultra - interior cleaner 400ml (Art. 2897-306)



02  
Interior cleaning set  
15 pieces

► Item no. 2000-001

► Content:

- 3 x interior cleaner Interno, 500 ml (Item No. 2000-05)
- 3 x Stries glass cleaner 500 ml (Item No. 2897-340)
- 3 x Velvet upholstery cleaner 400 ml (Item No. 2897-307)
- 6 x microfibre cloth blue, 40 X 40 cm (Item No. 2000-640-40)



03  
Exterior cleaning set Cleeno  
9 pieces

► Item no. 2000-002

► Content:

- 1 x All Star 5 liters (Item No. 2000-312-5)
- 1 x Rimol Profi Alloy Wheel Cleaner 5 liters (Item No. 2897-321-5)
- 2 x spout tap for 5 liter containers (item no.2000-000-005)
- 1 x pressure pump spray bottle blue 1 liter for All-Star (Item No. 2000-100)
- 1 x pressure pump spray bottle black 1 liter for Rimol Profi (item no. 2897-333-150)
- 1 x cleaning glove „chemistry“ GR. 9 (Item no.7797-009-9)
- 1 x cleaning glove „chemistry“ GR. 10 (Item No. 7797-009-10)
- 1 x VISION Protect protective goggles (Item No. 7794-005-0)





01

**Tire care product containing silicone**

New Wheel Extreme

- ▶ Item no. 2897-338-400
- ▶ Content: 400 ml
- ▶ Quantity per box: 12

- ▶ Technical specifications
- waterproof
- dries quickly
- contains silicone

02

**Silicone-free tire care product**

New Wheel Plus

- ▶ Item no. 2897-339-400
- ▶ Content: 400 ml
- ▶ Quantity per box: 12

- ▶ Technical specifications
- waterproof
- dries quickly
- silicone free



03

**Tire care cream**

New Wheel Protect

- ▶ Item no. 2897-338-250
- ▶ Content: Size 10
- ▶ Quantity per box: 24

- ▶ Technical specifications
- fast



01

**Nitrile protective gloves „YELLOW“**

- ▶ Technical specifications
- lightweight assembly glove with partial nitrile coating
- good dry grip
- Cotton jersey with knitted waistband
- European quality
- 
- Manufacturer information:
- EN standard 388
- Cat. 2
- Achievement value 4121



Item No.	size	PU	Quantity per box
7798-007-8	8	1	12/144
7798-007-9	9	1	12/144
7798-007-10	10	1	12/144
7798-007-11	11	1	12/144

02

**Nitrile protective gloves „BLUE“**

- ▶ Technical specifications
- double coating (lower: full nitrile coating, upper: sanded nitrile)
- Partially coated on the palm and fingertips
- highest dexterity
- Knitted cuff
- water repellent
- perfect oil grip
- 
- EN standards 420/388
- Achievement value 4121



Item No.	size	PU	Quantity per box
7798-006-8	8	1	
7798-006-9	9	1	
7798-006-10	10	1	
7798-006-11	11	1	

03

**Disposable gloves „NITRILE“**

- ▶ Technical specifications
- Nitrile
- powder-free
- unsterile
- wearable on both sides
- manufactured according to EN 455
- 100 pieces per box
- Food approval



Item No.	size	PU	Quantity per box
0798-001-8	8	1	10/100
0798-001-9	9	1	10/100
0798-001-10	10	1	10/100

04

**„Chemistry“ cleaning glove**

- ▶ Technical specifications
- Chemical protective gloves
- Nitrile
- Length 32 cm
- velor
- packed in pairs in poly bags
- for food contact



Item No.	size	PU	Quantity per box
7798-009-8	8	1	12/144
7798-009-9	9	1	12/144
7798-009-10	10	1	12/144
7798-009-11	11	1	12/144



01

**Respirator**

FFP2

- ▶ Item no. 0899-5
- ▶ PU: 20
- ▶ Technical specifications
  - high filtration efficiency
  - low breathing resistance
  - individually welded
  - 2 pieces in a cardboard box
  - 20 in a packaging unit
  - especially skin-friendly
  - Protection class FFP2
  - Size: 110 x 160 mm
  - 4 layer filter system
  - Weight: 7g per mask
  - foldable and soft material
  - non medical: EN149: 2001 A1: 2009
  - CE mark 2797



02

**Pro-Vision safety glasses**

with laminated glass

- ▶ Item no. 4695-006-500
- ▶ Technical specifications
  - Glasses in a sporty design protect the eyes at work thanks to shatterproof laminated glass



03

**X-one safety glasses**

scratch-resistant coating

- ▶ Item no. 7794-001-0
- ▶ Technical specifications
  - scratch-resistant coated
  - very light glasses (28g)
  - sporty design
  - Highest UV protection (100%)
  - universal fit despite simple temples



04

**Donor**

for earplugs

- ▶ Item no. 7695-006-500
- ▶ Technical specifications
  - Incl. Mounting material
  - without content
  - matching articles 7695-006-501 and 7695-006-502



05

**Ear plugs**

300 pairs

- ▶ Item no. 7695-006-501
- ▶ Technical specifications
  - made of soft PU
  - loose in a large polybag
  - conical shape
  - high wearing comfort
  - permanent recovery
  - excellent insulation values
  - EN 352-2
  - SNR 34 db (A)
  - H 33 db (A)
  - M 31 db (A)



06

**Ear plugs**

50 pairs

- ▶ Item no. 7695-006-502
- ▶ Technical specifications
  - made of soft PU
  - conical shape
  - high wearing comfort
  - permanent recovery
  - excellent insulation values
  - EN 352-2
  - SNR 34 db (A)
  - H 33 db (A)
  - M 31 db (A)
  - L 28 db (A)



07

**Ear plugs**

100 pairs

- ▶ Item no. 7695-006-600
- ▶ Technical specifications
  - without tape
  - hygienically packed in pairs

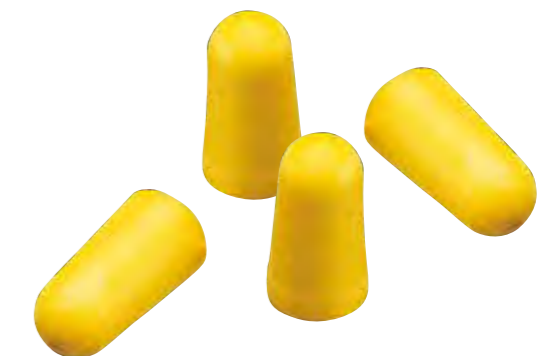

01

**bottle**

transparent, 500 ml

- ▶ Item no. 2000-803
- ▶ Technical specifications
  - with level indicator
  - Delivery WITHOUT pump and spray head



02

**Processing bottle**

Gray

- ▶ Item no. 2000-356-500 | 500 ml
- ▶ Technical specifications
  - without closure



03

**Push-pull closure**

for 500ml and 1000ml bottles

- ▶ Item no. 2000-356-2
- ▶ Technical specifications
  - for 500ml and 1000ml processing bottles



04

**Hand sprayer**

for 500ml container (Item No. 2000-803)

- ▶ Item no. 2000-802
- ▶ Technical specifications
  - leakproof
  - Infinitely adjustable nozzle from fine spray mist to jet



05

**Hand sprayer**

flexible, for 500ml container (Item No. 2000-803)

- ▶ Item no. 2000-802-2
- ▶ Technical specifications
  - for overhead work
  - leak-proof, with Viton seal
  - Infinitely adjustable nozzle from fine spray mist to jet



06

**Hand sprayer**

for every 1 liter container

- ▶ Item no. 2000-802-1
- ▶ Technical specifications
  - for 1 liter bottles
  - leakproof
  - Infinitely adjustable nozzle from fine spray mist to jet





01

**Pressure pump spray bottle**

for acidic liquids

► Item no. 2897-333-100

► Technical specifications

- Operating pressure 3 bar
- unfilled
- Capacity 1 liter
- Labels available separately for better recognition
- Suitable replacement seal (optionally available): Article no. 2897-333-101?
- For filling with the following Normfest products:
- Bremtec brake cleaner
- Power-Star tar remover
- Motor-Fit engine compartment preservation
- Oxime rust remover

**Replacement seal**

for acidic liquids

► Item no. 2897-333-101



02

**Pressure pump spray bottle**

for Bremtec Safe

► Item no. 2897-333-170

► Technical specifications

- Operating pressure 3 bar
- unfilled
- Capacity 1 liter
- Labels available separately for better recognition
- including a replacement seal set (Item No. 2897-333-171)
- 
- For filling with the following Normfest product:
- Bremtec Safe brake cleaner

**Replacement seal**

for Bremtec Safe bottle

► Item no. 2897-333-171



03

**Pressure pump spray bottle**

for acid-free liquids

► Item no. 2000-100

► Technical specifications

- Capacity 1 liter
- Operating pressure 3 bar
- unfilled
- Suitable replacement seal (optionally available): Article no. 2000-101
- Labels for better recognition (optionally available): Article no. 1960-000 ...
- 
- For filling with the following Normfest products:
- Uni-Star universal cleaner
- All-Star Power Cleaner
- Interno interior intensive cleaner

**Replacement seal**

for acid-free liquids

► Item no. 2000-101



04

**Pressure pump spray bottle**

for acidic liquids

► Item no. 2897-333-150

► Technical specifications

- Capacity 1 liter
- Operating pressure 3 bar
- unfilled
- Matching replacement seal (optionally available): Item no. : 2897-333-151
- Labels for better recognition (optionally available): Article no. 1960-000 ...
- 
- For filling with the following Normfest products:
- Rimol wheel cleaner
- Rimol Gold wheel cleaner
- Mega-Star flash rust remover

**Replacement seal**

for acidic liquids (Rimol Profi)

► Item no. 2897-333-151



01

**Tornador Gun Classic**

► Item no. 8696-560-002

► Technical specifications

- stronger impulse - more power - better cleaning
- integrated compressed air regulator
- integrated joint nipple
- ergonomic, cold-insulated and low-vibration
- suitable for 2.2 kW - 240 V piston compressors
- designed for continuous professional use



Item No.	Article name	execution
8696-1-831	SUCTION BALL WITH RISER HOSE	Tornador Gun Classic
8696-1-836	SUPPLEMENTARY CUP WITH CAP	Tornador Gun Classic
8696-3-833	INNER GUIDE HOSE	Tornador Gun Classic
8696-3-834	ROTATING HOSE FOR THE TORNADOR CLASSIC	Tornador Gun Classic
8696-1-832	Locking valve	Tornador Gun Classic
8696-3-835	Funnel	Classic 1. Serie
8696-4-835	Funnel	Classic and Black Series 1
8696-1-835	Funnel	Classic and Black Series 1
8696-1-837	Funnel with metal ring	Tornador Gun Classic
8696-3-832	TRICHTER	Tornador Gun Classic

02

**Tornador Gun Black**

► Item no. 8696-560-001

► Technical specifications

- particularly fine micro-atomization
- integrated compressed air regulator
- integrated joint nipple
- with proven Tornador® hose technology
- ergonomic, cold-insulated and low-vibration
- for 2.2kW - 230V piston compressors



Item No.	Article name	execution
8696-1-831	SUCTION BALL WITH RISER HOSE	Tornador Gun Classic
8696-3-831	SUCTION BALL RISER HOSE TORNADOR 2016	Tornador Gun Black
8696-1-836	SUPPLEMENTARY CUP WITH CAP	Tornador Gun Classic
8696-2-833	INNER GUIDE HOSE	Tornador Gun Black
8696-4-831	ROTATION SET for TORNADOR-GUN BLACK 2016	Black Series 1 and 2
8696-1-832	Locking valve	Tornador Gun Classic
8696-4-835	Funnel	Classic and Black Series 1
8696-4-832	Funnel	Black Series 1 and 2
8696-560-003	1/4" FLEXIBLE COMPRESSED AIR CONNECTION	



01

**Pressure pump sprayer**

for all Normfest cleaners

► Item no. 2000-806

► Technical specifications

- Plastic container
- 4 bar operating pressure
- for detergents with a pH value of 1-7
- with liter scale
- chemically resistant Viton seals
- 1.5 m chemical-resistant spray hose
- 50 cm curved stainless steel spray tube
- Flat jet nozzle with nozzle head made of stainless steel, Ø 0.91 mm
- Pressure relief valve
- Compressed air connection
- integrated funnel
- Stainless steel revolver valve
- 
- Scope of delivery:
- container
- tube
- Spray tube
- Clasp
- WITHOUT shoulder strap
- WITHOUT hand pump to build up pressure



02

**Hand pump**

for pressure pump sprayer (Item No. 2000-806)

► Item no. 2000-806-1

- Technical specifications
- for Uni-Star, All-Star and Topas



03

**Replacement clasp**

for pressure pump sprayer (Item No. 2000-806)

► Item no. 2000-806-2



**01**  
**Wet and dry vacuum cleaner**  
NF1200W

- ▶ Item no. 7983-010-1
- ▶ Product description
- Power: 1200 watts - max. 1400 watts
- Air flow: 215 m<sup>3</sup> / hour
- Volume: 60 dB
- Tank capacity: 21 liters
- Weight: 9.2 kg
- Height: 54cm
- Width below: 40cm
- Width at the head: 34cm
- 
- Scope of delivery:
- Power cable: 8.5 m
- Suction hose: 4.0 m
- Suction hose Ø: 36 mm
- Crevice nozzle 35 cm long
- Bristle nozzle
- Upholstery nozzle
- dust filter
- Sponge filter
- operation manual



**02**  
**Crack nozzle**  
For Normfest vacuum cleaner NT1200W item no. : 7983-010-1

- ▶ Item no. 7983-010-12
- ▶ Length: 35 cm
- ▶ Item no. 7983-010-19
- ▶ Length: 12 cm



**03**  
**Pet hair remover brush**  
For Normfest vacuum cleaner NT1200W item no. : 7983-010-1

- ▶ Item no. 7983-010-18
- ▶ Product description
- removes stubborn animal hair easily, quickly, thoroughly and efficiently
- Specially designed to remove pet hair from cars, clothing, mats, carpets, furniture, etc.
- fits all vacuum cleaners with tube dimensions 32 and 35 mm (99% of all vacuum cleaner types)



**04**  
**Upholstery nozzle standard**  
For Normfest vacuum cleaner NT1200W item no. : 7983-010-1

- ▶ Item no. 7983-010-14



**05**  
**Bristle nozzle**  
For Normfest vacuum cleaner NT1200W item no. : 7983-010-1

- ▶ Item no. 7983-010-13
- ▶ Product description
- Ø 35 mm



**06**  
**Suction hose**  
For Normfest vacuum cleaner NT1200W item no. : 7983-010-1

- ▶ Item no. 7983-010-11
- ▶ Product description
- Length: 4 m
- Ø 36 mm



**07**  
**Suction hose holder**  
For Normfest vacuum cleaner NT1200W item no. : 7983-010-1

- ▶ Item no. 7983-010-17



**08**  
**Dust filter standard**  
for NT1200W and NT1200SP

- ▶ Item no. 7983-010-15



**09**  
**Sponge filters for liquids**  
for NT1200W and NT1200SP

- ▶ Item no. 7983-010-16
- ▶ Product description
- For Normfest vacuum cleaner NT1200W item no. : 7983-010-1





01

**Wet-dry vacuum cleaner**

NF1200 SP

► Item no. 7983-011-1

► Product description

- with spray function
- Power: 1200 watts - max. 1400 watts
- Air flow: 215 m<sup>3</sup> / hour
- Volume: 60 db
- Total tank capacity: 37 liters
- Pump tank: 8 liters
- Pump pressure: 2 bar
- Pump motor: 48 watts
- Weight: 17.6 kg
- Height: 77cm
- Width below: 40cm
- Width at the top: 36cm
- 
- Scope of delivery:
- Power cable: 8.5 m
- Suction hose: 2.5 m
- Suction hose Ø: 40mm
- Hose package including liquid hose
- Fan jet nozzle with lever
- Sponge filter
- Anti-foam adapter
- dust filter
- operation manual



02

**Bristle nozzle**

For Normfest vacuum cleaner NT1200W item no. : 7983-010-1

► Item no. 7983-010-13

► Product description

- Ø 35 mm



03

**Suction hose**

For Normfest suction cups NT1200WSP item no. : 7983-011-1

► Item no. 7983-011-12

► Product description

- 40mm x 2.5m



05

**Dust filter for NT1200WSP**

For Normfest suction cups NT1200WSP item no. : 7983-011-1

► Item no. 7983-011-15



07

**Anti-foam adapter**

For Normfest suction cups NT1200WSP item no. : 7983-011-1

► Item no. 7983-011-14



04

**Suction hose holder**

For Normfest suction cups NT1200WSP item no. : 7983-011-1

► Item no. 7983-011-11



06

**Sponge filters for liquids**

for NT1200W and NT1200SP

► Item no. 7983-010-16

► Product description

- For Normfest vacuum cleaner NT1200W item no. : 7983-010-1





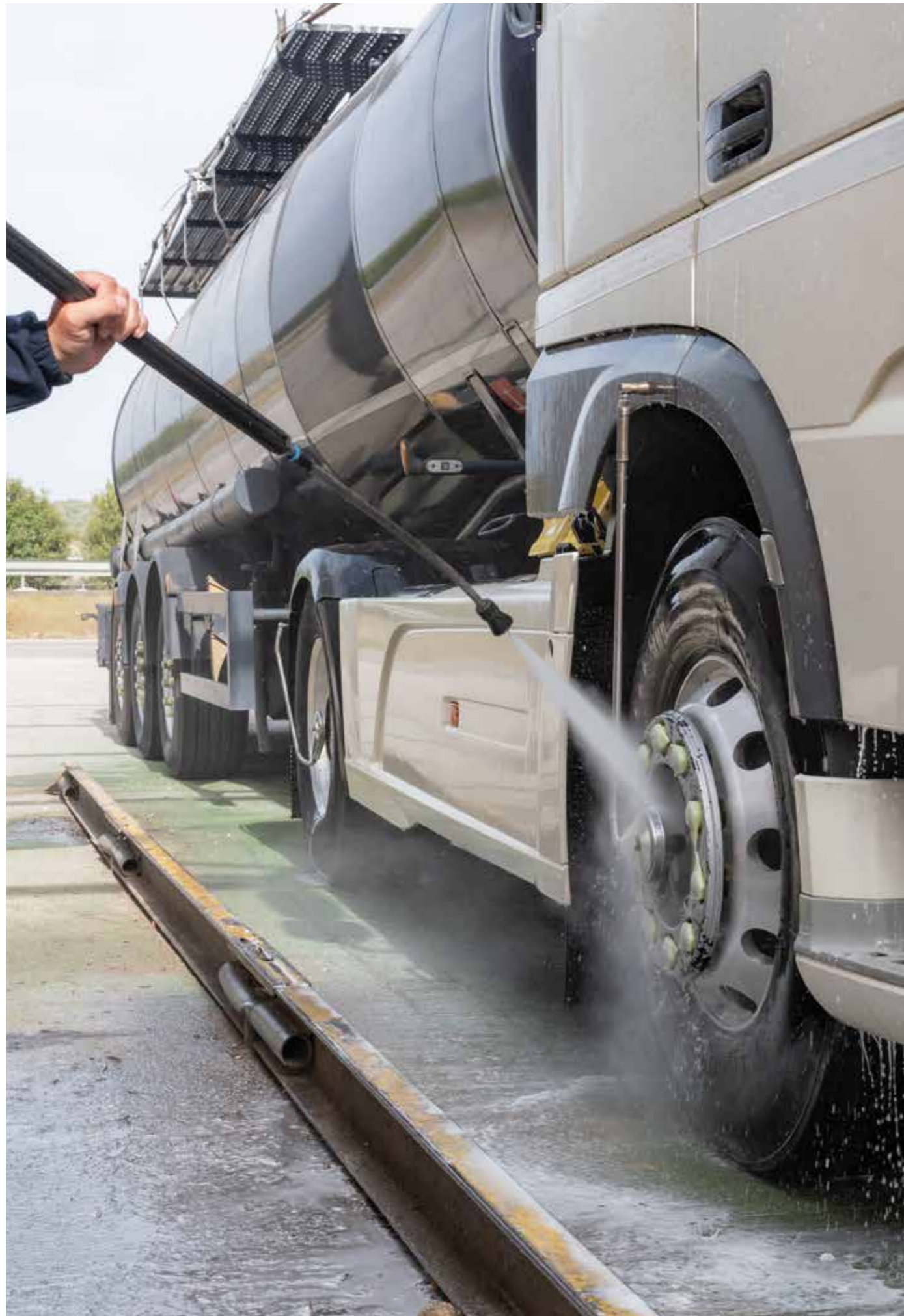

01

**high pressure cleaner**  
HD 5/15 C Plus

► Item no. 2000-550-2

## ► Technical specifications

- Hand spray gun with Easy Press
- Hand gun with softgrip insert
- High pressure hose 10 m long
- Steel tube, 850 mm
- Manual triple nozzle (0 ° / 25 ° / 40 °)
- Anti-twist system
- Pressure cut-off









01

**Air conditioning evaporator cleaner**

Viro Vaporizer

- ▶ Item no. 2897-303
- ▶ Content: 400 ml
- ▶ Quantity per box: 12

## ▶ Technical specifications

- cleans with high pressure flushing
- works in every corner of the evaporator
- Sustainably kills germs, bacteria and molds
- prevents new colonization of microorganisms
- ensures healthy and fragrant air in the vehicle
- incl. 60 cm long hose with rotary nozzle
- a can is sized for use in a vehicle interior

VIDEO



02

**Air conditioning cleaner**

Viro Dry Shot

- ▶ Item no. 2897-304
- ▶ Content: 100ml
- ▶ Quantity per box: 12

## ▶ Technical specifications

- fine & dry nebulising
- highly effective active ingredient
- long-lasting and germ-neutralising effect
- pleasant fragrance
- completely new formula
- one can is sufficient for one application in a vehicle interior



VIDEO



03

**Air conditioning and ventilation system cleaner**

Viro Air Fresh Plus

- ▶ Item no. 2897-302
- ▶ Content: 300 ml
- ▶ Quantity per box: 12

## ▶ Technical specifications

- the spray is fed directly into the ventilation system by means of a capillary tube
- long-lasting destruction of bacteria
- leaves a citrus-fresh scent
- Content is sufficient for up to three applications
- Base: alcohol

04

**Replacement spray head**

with capillary tube

- ▶ Item no. 2897-300-140
- ▶ Packing unit: 2

## ▶ Technical specifications

- for the targeted application of low-viscosity materials as well as oils and thin pastes



VIDEO





01

### Air conditioning compressor oil for refrigerant R134a PAG 46 Oil

- ▶ Item no. 5000-220
- ▶ Content: 250 ml
- ▶ Quantity per box: 12

#### ▶ Technical specifications

- low viscosity
- fully synthetic, water-binding oil
- for the lubrication of all moving parts in the air conditioning compressors
- protects the air conditioning circuit from corrosion and moisture
- is distributed evenly in the air conditioning circuit
- ensures an optimal return flow to the compressor



02

### Air conditioning compressor oil for refrigerant R134a PAG 100 Oil

- ▶ Item no. 5000-221
- ▶ Content: 250 ml
- ▶ Quantity per box: 12

#### ▶ Technical specifications

- high viscosity
- fully synthetic, water-binding oil
- for the lubrication of all moving parts in the air conditioning compressors
- protects the air conditioning circuit from corrosion and moisture
- is distributed evenly in the air conditioning circuit
- ensures an optimal return flow to the compressor



03

### Multigrade compressor oil Multi-POE Oil

- ▶ Item no. 5000-219-1
- ▶ Content: 1 litre
- ▶ Quantity per box: 12

#### ▶ Technical specifications

- A multigrade compressor oil for all passenger cars, hybrid vehicles, trucks, buses and agricultural machinery that are filled with refrigerant 1234yf or R134a
- for reducing wear, lubrication and cooling of air conditioning compressors in the refrigerant area
- Compatible with all known mineral, ester and PAG oils



04

### Air conditioning compressor oil for refrigerant 1234yf PAG46 Oil

- ▶ Item no. 5000-218
- ▶ Content: 250 ml
- ▶ Quantity per box: 12

#### ▶ Technical specifications

- a multigrade compressor oil for all passenger cars, hybrid vehicles, trucks, buses and agricultural machines that are filled with refrigerant 1234yf
- perfectly lubricates and cools air conditioning compressors
- ensures thermal stability in the compressor



01

**UV leak detection fluid**

UV flex

- ▶ Item no. 5000-306
- ▶ Content: 250 ml
- ▶ Quantity per box: 12
  
- ▶ Technical specifications
- for use in connection with refrigerant oils (PAG, mineral oils and esters)
- completely harmless to all hybrid vehicle air conditioning systems and service devices
- suitable for both refrigerants (R134a



02

**UV leak detection fluid Tracer®**

- ▶ Item no. 5000-305
- ▶ Content: 237 ml
- ▶ Quantity per box: 6
- ▶ suitable for: R1234yf
  
- ▶ Technical specifications
- this leak detection additive does not contain any solvents
- for use in connection with refrigerant oils (PAG, mineral oil, ester)
- completely harmless to all vehicle air conditioning systems and air conditioning service devices
- Manufacturer approval
- for approx. 25 car applications



03

**UV leak detection fluid Tracer®**

- ▶ Item no. 5000-307
- ▶ Content: 250 ml
- ▶ Quantity per box: 6
- ▶ suitable for: R134a
  
- ▶ Technical specifications
- this leak detection additive does not contain any solvents
- for use in conjunction with refrigerant oils (PAG, mineral oil, ester)
- completely harmless for all vehicle air-conditioning systems and air-conditioning service units
- Manufacturer's approval
- for approx. 25 car applications



04

**Fluorescent leak detection fluid for engines and gears**

Air-Fresh Oil-Fluid

- ▶ Item no. 5000-205-1
- ▶ Content: 25 ml
- ▶ Quantity per box: 6
  
- ▶ Technical specifications
- fluorescent leak detection fluid
- for localizing micro-leaks in engines with an oil circuit and oil-filled gears
- sufficient for one vehicle or one application



05

**Fluorescent leak detection fluid for cooling water circuit**

Air-Fresh Water-Fluid

- ▶ Item no. 5000-206-1
- ▶ Content: 25 ml
- ▶ Quantity per box: 6
  
- ▶ Technical specifications
- fluorescent leak detection fluid
- for localizing micro leaks in the water cooling circuit
- sufficient for one vehicle or one application





01

**Trace gas leak detection set**

11 pieces

▶ Item no. 5000-5

▶ Technical specifications

- Leak detection system based on nitrogen 95% and hydrogen 5%
- 
- Contents of the complete set in the case:
  - Hydrogen leak detector
  - Trace gas pressure reducer
  - Test fitting
  - Connection hose between trace gas pressure reducer and high-pressure quick coupling
  - Connection hose between the low-pressure quick coupling and the test fitting
  - High pressure quick coupling
  - Low pressure quick coupling
  - Gas bottle content: 2 liters
  - earphones
  - Charger
  - CD-ROM

02

**Forming gas for trace gas leak detection**

2 liters

▶ Item no. 5000-52

▶ Technical specifications

- Replacement bottle for the trace gas leak detection system (item no. 5000-5)



03

**UV protective glasses**

Air-Fresh

▶ Item no. 5000-202

▶ Technical specifications

- for working with fluorescent leak detection liquids



04

**UV lamp set LED**

5 parts

▶ Item no. 5000-201

▶ Technical specifications

- the UV light makes fluorescent leak detection liquid glow
- Content:
  - 1x UV glasses, 1x UV lamp 3.6V 150W with grid reflector (incl. 3 x micro batteries item no. 3722-04)





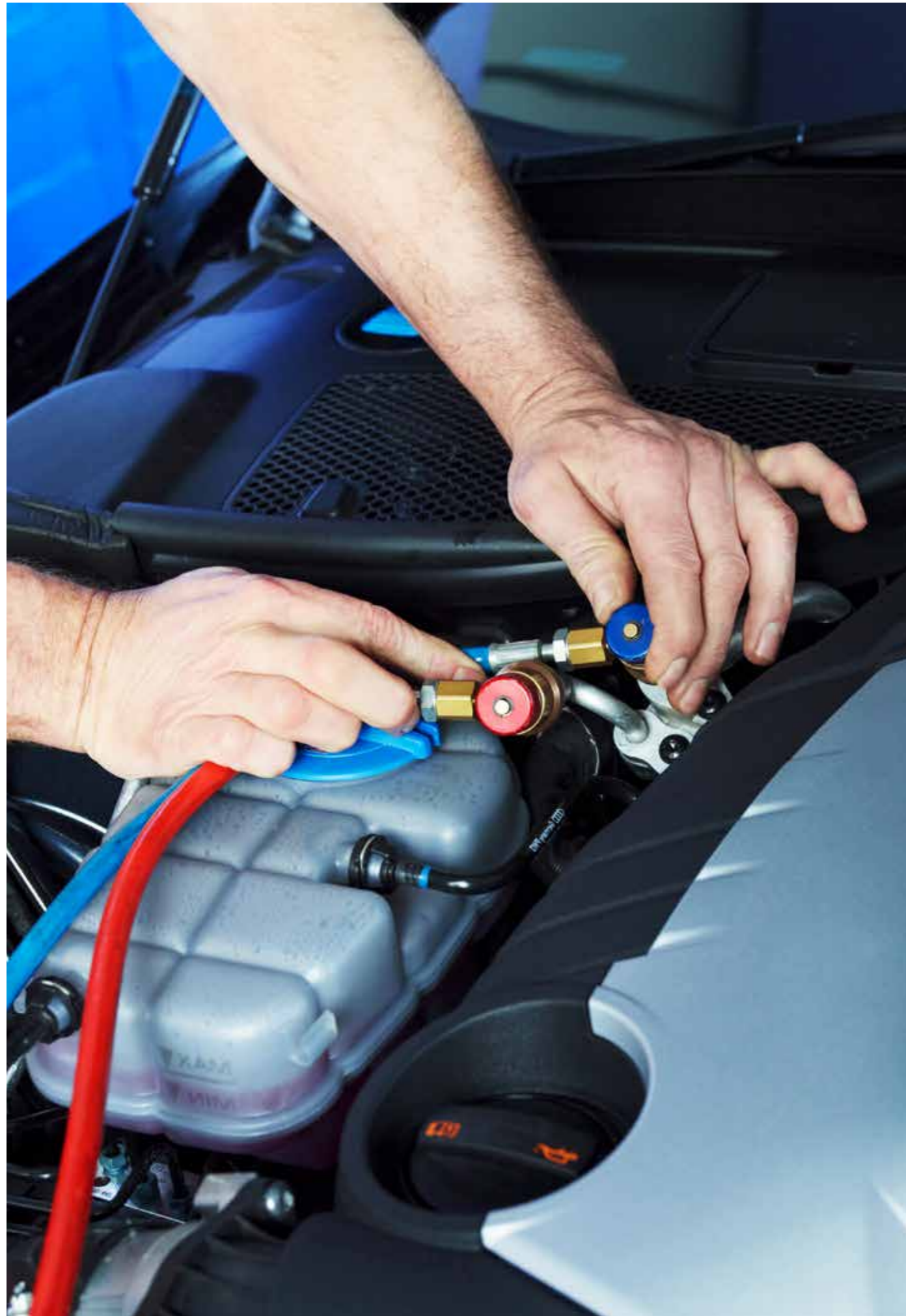

02

**Adapter set**  
for R1234yf returnable bottle

- ▶ Item no. 5000-229-1
- ▶ Technical specifications
  - A distinction is made between the following adapters:
  - Honeywell 1/2" -16 ACME LH
  - DuPont W 21.8 x 1/14" LH
  - The DuPont adapter can also be used for our bottles.



03

**Connection adapter**  
for R134A returnable bottle

- ▶ Item no. 5000-226-1
- ▶ Technical specifications
  - 1/4" with SAE male thread and seal
  - Specified low pressure adapter for connection to service stations



04

**Adapter hose device R1234YF**  
für R1234yf Mehrwegflasche

- ▶ Item no. 5000-5-001
- ▶ Technical specifications
  - Connection thread M12 x 1.5



05

**Quick coupling**  
R1234yf BF

- ▶ Item no. 5000-5-002
- ▶ Technical specifications
  - Low pressure
  - Connection thread M12 x 1.5mm
  - blue



06

**Quick coupling**  
R1234yf RF

- ▶ Item no. 5000-5-003
- ▶ Technical specifications
  - High pressure
  - Connection thread M12 x 1.5mm
  - red



07

**Thermal paper roll**  
for air conditioning service devices

- ▶ Item no. 5000-235
- ▶ Technical specifications
  - special printer paper for thermal printers of the ASC series
  - Roll width: 58 mm
  - Length: 10 meters





01

**O-rings for air conditioning**

for car air conditioning systems with R134a



Item No.	Inside Ø:	Strength:	pcs.
5000-003	4,47 mm	1,78 mm	20
5000-032	6,02 mm	2,62 mm	20
5000-007	6,07 mm	1,78 mm	20
5000-077	6,65 mm	2,70 mm	20
5000-074	6,70 mm	1,60 mm	20
5000-067	6,70 mm	1,70 mm	20
5000-075	6,80 mm	1,90 mm	20
5000-070	6,95 mm	2,2 mm	20
5000-069	7,00 mm	2,5 mm	20
5000-002	7,50 mm	2,0 mm	20
5000-068	7,50 mm	2,5 mm	20
5000-050	7,65 mm	1,63 mm	20
5000-012	7,65 mm	1,78 mm	20
5000-071	8,00 mm	1,80 mm	20
5000-004	8,00 mm	2,0 mm	20
5000-072	8,80 mm	1,90 mm	20
5000-006	8,92 mm	1,83 mm	20
5000-016	9,25 mm	1,78 mm	20
5000-005	9,25 mm	2,39 mm	20
5000-060	9,50 mm	2,5 mm	20
5000-052	9,60 mm	1,88 mm	20
5000-073	10,00 mm	2,0 mm	20
5000-008	10,00 mm	2,5 mm	20
5000-010	10,12 mm	1,85 mm	20
5000-013	10,50 mm	2,0 mm	20

Item No.	Inside Ø:	Strength:	pcs.
5000-034	10,77 mm	2,62 mm	20
5000-009	10,80 mm	2,00 mm	20
5000-061	10,80 mm	2,40 mm	20
5000-017	10,82 mm	1,78 mm	20
5000-079	11,11 mm	1,78 mm	20
5000-062	11,50 mm	2,5 mm	20
5000-047	12,01 mm	1,88 mm	20
5000-035	12,37 mm	2,62 mm	20
5000-063	13,40 mm	1,78 mm	20
5000-064	13,80 mm	2,40 mm	20
5000-036	13,94 mm	2,62 mm	20
5000-023	14,00 mm	1,78 mm	20
5000-065	14,25 mm	2,40 mm	20
5000-021	14,30 mm	2,30 mm	20
5000-066	14,50 mm	2,5 mm	20
5000-043	15,47 mm	3,53 mm	20
5000-026	15,68 mm	1,93 mm	20
5000-029	17,00 mm	2,0 mm	20
5000-028	17,17 mm	1,78 mm	20

02

**Universal O-ring range**

small diameter

► Item no. 1957-500-1

► Technical specifications

- common O-rings for car air conditioning
- Contents: 360 parts
- 20 x 4.47 x 1.78 (Item No. 5000-003)
- 20 x 6.02 x 2.62 (Item No. 5000-032)
- 20 x 6.07 x 1.78 (Item No. 5000-007)
- 20 x 6.70 x 1.70 (Item No. 5000-067)
- 20 x 6.95 x 2.20 (Item No. 5000-070)
- 20 x 7.50 x 2.50 (Item No. 5000-068)
- 20 x 7.65 x 1.63 (Item No. 5000-012)
- 20 x 7.65 x 1.78 (Item No. 5000-050)
- 20 x 7.00 x 1.50 (Item No. 5000-069)
- 20 x 8.00 x 1.80 (Item No. 5000-071)
- 20 x 8.00 x 2.00 (Item No. 5000-004)
- 20 x 8.80 x 1.90 (Item No. 5000-072)
- 20 x 9.25 x 1.78 (Item No. 5000-016)
- 20 x 9.25 x 2.39 (Item No. 5000-005)
- 20 x 9.50 x 2.50 (Item No. 5000-060)
- 20 x 10.12 x 1.85 (Item No. 5000-010)
- 20 x 10.00 x 2.00 (Item No. 5000-073)
- 20 x 10.00 x 2.50 (Item No. 5000-008)



03

**Universal O-ring range**

large diameter

► Item no. 1957-500-2

► Technical specifications

- most common O-rings for truck air conditioning
- Contents: 360 parts
- 20 x 10.77 X 2.62 (Item No. 5000-034)
- 20 x 10.80 X 2.40 (Item No. 5000-009)
- 20 x 10.80 X 2.40 (Item No. 5000-061)
- 20 x 10.82 X 1.78 (Item No. 5000-017)
- 20 x 11.50 X 2.50 (Item No. 5000-062)
- 20 x 12.01 X 1.88 (Item No. 5000-047)
- 20 x 12.37 X 2.62 (Item No. 5000-035)
- 20 x 13.40 X 1.78 (Item No. 5000-063)
- 20 x 13.80 X 2.40 (Item No. 5000-064)
- 20 x 13.94 X 2.62 (Item No. 5000-036)
- 20 x 14.00 X 1.78 (Item No. 5000-023)
- 20 x 14.25 X 2.40 (Item No. 5000-065)
- 20 x 14.30 X 2.30 (Item No. 5000-021)
- 20 x 14.50 X 2.50 (Item No. 5000-066)
- 20 x 15.47 X 3.53 (Item No. 5000-043)
- 20 x 15.68 X 1.93 (Item No. 5000-026)
- 20 x 17.17 X 1.78 (Item No. 5000-028)
- 20 x 17.00 X 2.00 (Item No. 5000-029)



01

**Springlock tool**

- ▶ Technical specifications
- Tool to enable service work on the Spring-Lock system
- permanent leaks can be avoided with this tool

- ▶ Item no. 5000-114
- ▶ Manufacturer: Ford
- ▶ Size: 3/8"
- ▶ Colour: red



- ▶ Item no. 5000-116
- ▶ Manufacturer: Ford
- ▶ Size: 5/8"
- ▶ Colour: black



- ▶ Item no. 5000-115
- ▶ Manufacturer: Ford
- ▶ Size: 1/2"
- ▶ Colour: blue



- ▶ Item no. 5000-117
- ▶ Manufacturer: Ford
- ▶ Size: 3/4"
- ▶ Colour: white



- ▶ Item no. 5000-118
- ▶ Manufacturer: Opel
- ▶ Size: 3/8"
- ▶ Colour: red



- ▶ Item no. 5000-119
- ▶ Manufacturer: Opel
- ▶ Size: 1/2"
- ▶ Colour: blue



04

**Air conditioning valve**

Audi

- ▶ Item no. 5000-127
- ▶ Packing unit: 5



05

**Air conditioning valve**

JRA HNBR

- ▶ Item no. 5000-125
- ▶ Packing unit: 5



06

**Air conditioning valve**

8 mm, Eaton

- ▶ Item no. 5000-123
- ▶ Packing unit: 5



07

**Air conditioning valve**

10 mm, Eaton

- ▶ Item no. 5000-124
- ▶ Packing unit: 5



08

**Air conditioning valve**

M8, Peugeot / Volvo

- ▶ Item no. 5000-122
- ▶ Packing unit: 5



09

**Air conditioning valve**

Renault

- ▶ Item no. 5000-126
- ▶ Packing unit: 5



10

**Valve insert**

Standard, high pressure

- ▶ Item no. 5000-106
- ▶ Packing unit: 20



11

**Valve tool big**

Eaton SSV

- ▶ Item no. 5000-120
- ▶ Packing unit: 1



12

**adapter**

R134a, 16 mm, low pressure

- ▶ Item no. 5000-113
- ▶ Packing unit: 1



13

**Valve tool small**

JRA standard

- ▶ Item no. 5000-121
- ▶ Packing unit: 1









01

**H7**

12V 55W Px26d

Item No.	execution	Manufacturer
3720-064-209	Long Life	OEM quality
3720-064-252	VisionPlus +50%	Philips
3720-064-265	12 V H7 set, +90%	OEM quality
3720-064-210	Ultra Life	Osram
3723-064-209	LL	Normlight
3723-064-201	standard	Normlight



02

**H4**

12V 60 / 55W P43t

Item No.	execution	Manufacturer
3720-064-220	Premium +30%	Philips
3720-064-251	VisionPlus +50%	Philips
3720-064-264	Set of 2, +90%	OEM quality
3720-064-193	standard	OEM quality
3723-064-193	standard	Normlight



03

**H1**

12V 55W 14.5s

Item No.	execution	Manufacturer
3720-064-221	Premium +30%	Philips
3720-064-250	VisionPlus +50%	Philips
3720-064-202	Spot	OEM quality
3720-064-150	standard	OEM quality
3723-064-150	standard	Normlight



04

**H3**

12V 55W PK22s

Item No.	Manufacturer
3720-064-156	OEM quality
3723-064-156	Normlight





01

**H8**

12V 35W PGJ19-1

▶ Item no. 3720-064-228



02

**H9**

12V 65W PGJ19-5

▶ Item no. 3720-064-229



03

**H11**

12V 55W PGJ19-2

▶ Item no. 3720-064-206



04

**H10 / 9145**

12V 42W PY20d

▶ Item no. 3720-064-218



05

**HIR2 / 9012**

12V 55W PX22D

▶ Item no. 3720-064-216



06

**HB3**

12V 60W P20d

▶ Item no. 3720-064-204



07

**HB4**

12V 51W P22d

▶ Item no. 3720-064-205





01

**S2 Duolux**

12V 35 / 35W BA20d

▶ Item no. 3720-073-27

▶ Technical specifications

- OEM quality
- Design: symmetrical with two light bodies
- Use: in two-wheeled vehicles



02

**R2 Duolux**

12V 45 / 40W P45t

▶ Item no. 3720-079-51

▶ Technical specifications

- OEM quality
- Design: asymmetrical



03

**D2S Xenon gas discharge lamp**

12 / 85V 35W P32d-2

▶ Item no. 3720-064-222

- ▶ Technical specifications
- for projection headlights
- approx. 4,100 Kelvin



04

**D2R Xenon Gasentladungslampe**

12 / 85V 35W P32d-3

▶ Item no. 3720-064-223

- ▶ Technical specifications
- for reflective headlights
- approx. 4,000 Kelvin



05

**D1S Xenon gas discharge lamp**

12 / 85V 35W PK32d-2

▶ Item no. 3720-064-224

- ▶ Technical specifications
- approx. 4,000 Kelvin
- 3200 lumens



06

**D3S Xenon gas discharge lamp**

12 / 42V 35W PK32d-5

▶ Item no. 3720-064-225

- ▶ Technical specifications
- for reflection headlights
- approx. 4,000 Kelvin
- 3,200 lumens



07

**D4S Xenon gas discharge lamp**

12 / 42V 35W P32d-5

▶ Item no. 3720-064-226

- ▶ Technical specifications
- for reflection headlights
- approx. 4,000 Kelvin
- 3,200 lumens



08

**D4R Xenon gas discharge lamp**

12 / 85V 35W P32d-6

▶ Item no. 3720-064-227

- ▶ Technical specifications
- for reflective headlights
- approx. 4,000 Kelvin
- 2,800 lumens





01

**12V indicator or brake light lamp**

Base BA15s

Item No.	power	Manufacturer
3720-075-06	21W	OEM quality
3720-075-27	18W	OEM quality
3723-075-06	21W	Normlight

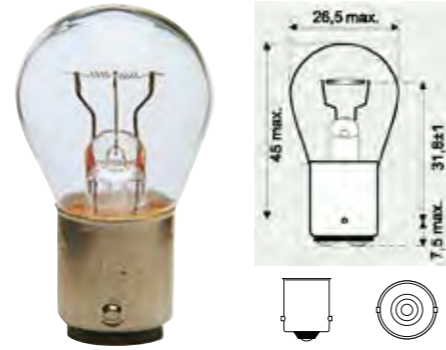

05

**12V 21W indicator lamp yellow**

Base BA15s

► Item no. 3720-075-071



02

**12W 21W trailer lamp for special applications**

Base BA15d

► Item no. 3720-075-05



06

**12V indicator light**

Base BAU15s

Item No.	power	Manufacturer
3720-075-07	21W	OEM quality
3723-075-07	21W	Normlight



03

**Brake and tail light lamp**

12V 21/5W BAY15d

Item No.	power	Manufacturer
3720-075-28	21/5W	OEM quality
3723-075-28	21/5W	Normlight

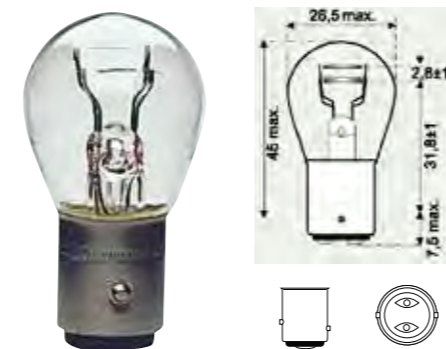

07

**12V 21W Silver Vision set PHILIPS for clear glass indicators**  
**Glass color silver, luminous color yellow**

Base BAU15s

► Item no. 3720-075-070

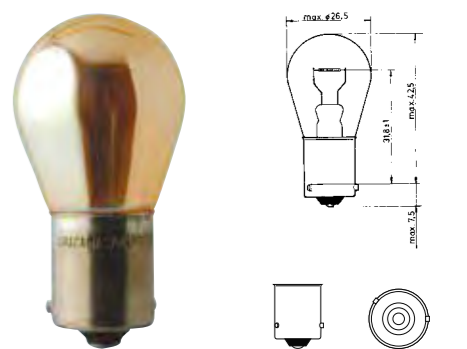

04

**12V 21 / 4W rear fog lamp**

Base BAZ15d

► Item no. 3720-075-08



08

**12V rear light red, for Ford vehicles**

Base BAW15s

Item No.	power	Manufacturer
3720-075-091	21/5W	OEM quality
3720-075-09	21W	OEM quality





01

**Taillight lamp**  
Base BA15s

Item No.	power	Manufacturer
3720-050-07	5W	OEM quality
3720-050-08	10W	OEM quality
3723-050-07	5W	Normlight
3723-050-08	10W	Normlight



02

**Taillight lamp**  
Base BA15d

► Item no. 3720-054-07



03

**12V parking light and indicator lamp**  
Base BA9s

Item No.	power
3720-037-96	2W
3720-038-94	3W
3720-038-93	4W



04

**12V license plate, interior and trunk lamp**  
Base BAX9s halogen

Item No.	power	Suitable for
3720-064-132	6W	
3720-064-133	21W	

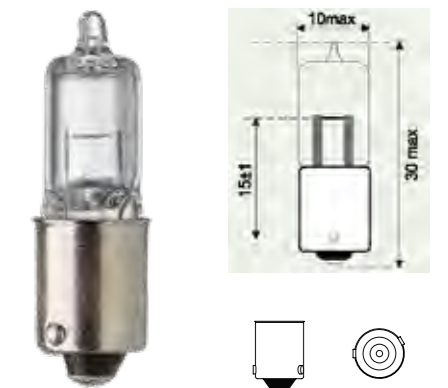

05

**12V license plate, interior and trunk lamp**  
Base BA9s halogen

Item No.	power
3720-064-190	5W
3720-064-191	10W
3720-064-192	20W





01

**12V fittings glass base lamp**

Base W2x4.6d

Item No.	power	execution	Manufacturer
3720-027-21	1,2W	OEM quality	OEM quality
3720-016-03	1,2W	matte	OEM quality
3723-027-21	1,2W	Normlight	Normlight
3720-027-23	1,7W	OEM quality	OEM quality
3720-027-22	2W	OEM quality	OEM quality

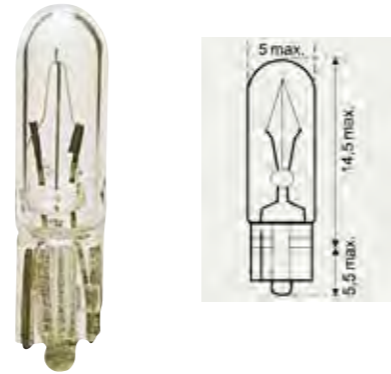

04

**Stern light glass base lamp**

Base W3x16d

Item No.	power	Manufacturer
3720-074-1	21W	OEM quality
3720-074-2	21/5W	OEM quality

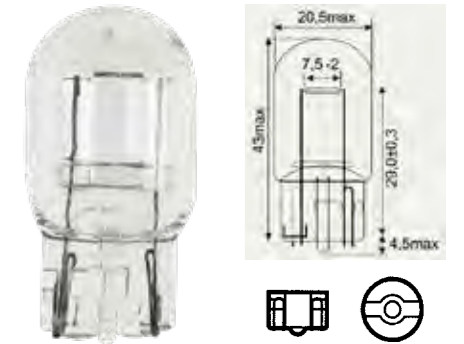

02

**12V parking light, side indicator and interior glass base lamp**

Base W2.1x9.5d

Item No.	power	execution	Manufacturer
3720-028-20	2W	OEM quality	OEM quality
3720-028-21	3W	OEM quality	OEM quality
3720-028-25	5W	OEM quality	OEM quality
3720-028-24	5W	5 W, amber	OEM quality
3720-028-26	5W	blue	OEM quality
3723-028-25	5W	Normlight	Normlight

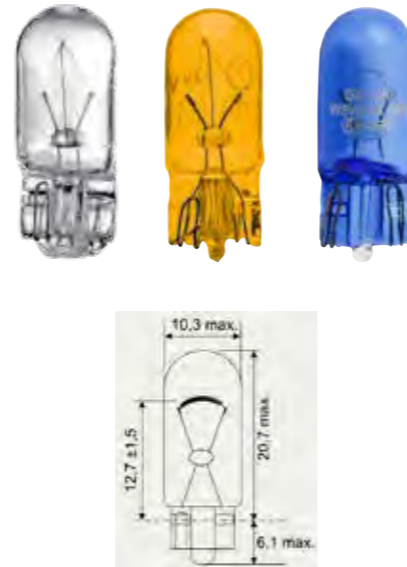

05

**12V 20W glass base lamp orange**

Base WY16W

► Item no. 3720-028-29



06

**12V 21W flashing light glass base lamp amber / yellow**

Base W3x16d

► Item no. 3720-074-3

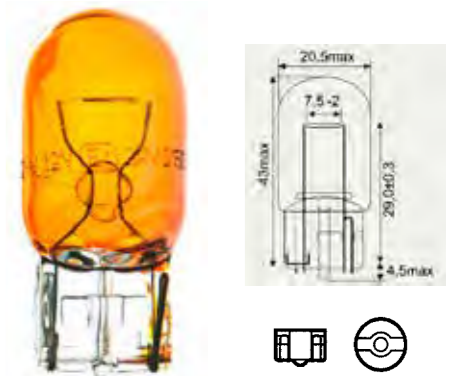

03

**Wedge base bulb**

Base W2.1x9.5d

► Item no. 3720-028-30

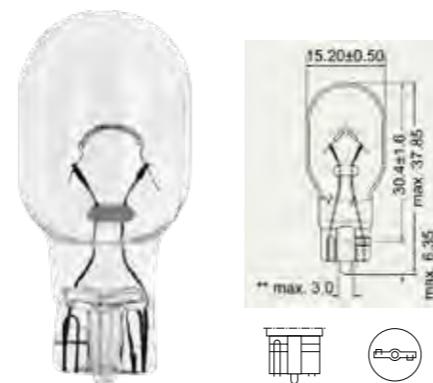

07

**12V 20W halogen pen lamp**

Base G4

► Item no. 3720-072-30

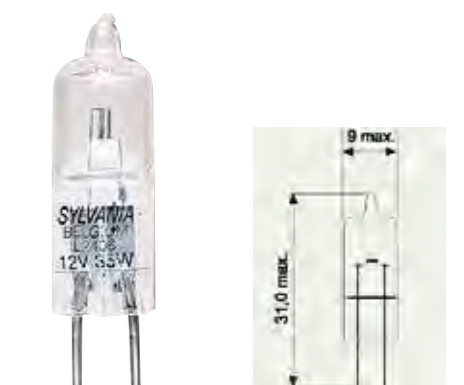

01

**Soffit lamp**

Base SV8,5-8

Item No.	power	length	O
3720-064-18	5W	35 mm	11 mm
3720-064-13	5W	41 mm	11 mm
3720-064-111	10W	28 mm	10 mm
3720-064-19	10W	35 mm	10 mm
3720-064-11	10W	41 mm	11 mm
3720-064-15	15 W	41 mm	15,5 mm
3720-064-75	18W	41 mm	15,5 mm
3720-064-76	21W	41 mm	15,5 mm



02

**12V 3W festoon lamp**

Socket SV6-7.6 28 mm

► Item no. 3720-064-28

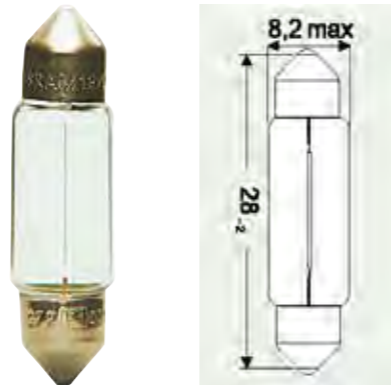

03

**Plastic base lamp**

W2x4.6d

Item No.	power	colour
3720-027-500	0,5W	grey
3720-027-501	1,2W	white



04

**Plastic base lamp**

B8,4d

Item No.	power	colour
3720-027-401	1,2W	black
3720-027-400	2,0W	turquoise



05

**Plastic base lamp**

B8.5d

Item No.	power	colour
3720-027-403	1,2W	black
3720-027-402	2,0W	green



06

**12 V 1.2 W black plastic base lamp**

B8,3d

► Item no. 3720-027-405



07

**12 V 1.2 W plastic base lamp gray**

Base B8.7d

► Item no. 3720-027-409

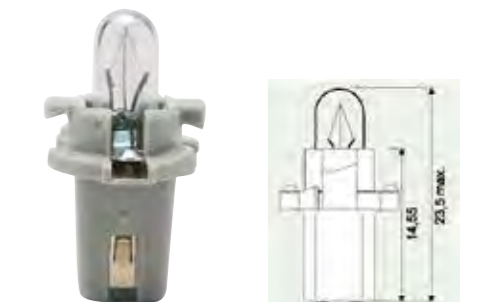



01

**12V H4 car lamp replacement box**

OEM quality

► Item no. 3720-02

► Content:

- 1x plug-in fuses 7.5A (item no. 3731-007-5)
- 1x plug fuses 10A (item no. 3731-010)
- 1x 15A plug fuses (item no. 3731-015)
- 1x 5W glass base lamp (item no. 3720-028-25)
- 1x parking light 4W (item no. 3720-038-93)
- 1x brake light 21 / 5W (Item No. 3720-075-28)
- 1x flashing light 21W item no. 3720-075-06)
- 1x license plate light 5W (item no. 3720-064-18)
- 1x main headlight bulb H4 (item no. 3720-064-193)



03

**12V H4 car lamp replacement box**

Normlight quality

► Item no. 3723-02

► Content:

- 1x plug fuse 7.5A (Item No. 3731-007-5)
- 1x plug-in fuse 10A (item no. 3731-010)
- 1x 15A plug-in fuse (item no. 3731-015)
- 1x 5W glass base lamp (item no. 3723-028-25)
- 1x parking light 4W (item no. 3720-038-93)
- 1x brake light 21 / 5W (Item No. 3723-075-28)
- 1x flashing light 21W (item no. 3723-075-06)
- 1x Soffite 8,5x8 5W (Item no. 3723-064-18)
- 1x main headlight H4 (item no. 3723-064-193)



02

**12V H1 / H7 car lamp replacement box**

OEM quality

► Item no. 3720-020

► Content:

- 1x plug-in fuses 7.5A (item no. 3731-007-5)
- 1x plug fuses 10A (item no. 3731-010)
- 1x 15A plug fuses (item no. 3731-015)
- 1x 5W glass base lamp (item no. 3720-028-25)
- 1x parking light 4W (item no. 3720-038-93)
- 1x brake light 21 / 5W (Item No. 3720-075-28)
- 1x flashing light 21W (item no. 3720-075-06)
- 1x Soffite 8.5x8 5W (Item no. 3720-064-18)
- 1x yellow 21W indicator lamp (item no. 3720-075-07)
- 1x main headlight bulb H7 (Item No. 3720-064-201)
- 1x main headlight bulb H1 (item no. 3720-064-150)



04

**12V H1 / H7 car lamp replacement box**

Normlight quality

► Item no. 3723-020

► Content:

- 1x plug fuse 7.5A (Item No. 3731-007-5)
- 1x plug-in fuse 10A (item no. 3731-010)
- 1x 15A plug-in fuse (item no. 3731-015)
- 1x 5W glass base lamp (item no. 3723-028-25)
- 1x parking light 4W (item no. 3720-038-93)
- 1x brake light 21 / 5W (Item No. 3723-075-28)
- 1x flashing light 21W (item no. 3723-075-06)
- 1x Soffite 8,5x8 5W (Item no. 3723-064-18)
- 1x yellow 21W indicator lamp (item no. 3723-075-07)
- 1x main headlight bulb H7 (item no. 3723-064-201)
- 1x main headlight bulb H1 (item no. 3723-064-150)





01

**H7**

24V 70W Px26d

Item No.	execution	Manufacturer
3720-064-274	HD / LL	Osram
3720-064-273	HD / LL	OEM quality
3723-064-211	standard	Normlight



02

**H4**

24V 75 / 70W P43t

Item No.	execution	Manufacturer
3720-064-272	HD / LL	OEM quality
3723-064-196	standard	Normlight
3723-064-197	HD	Normlight



03

**H1**

24V 70W P14.5s

Item No.	execution	Manufacturer
3720-064-270	HD / LL	OEM quality
3723-064-155	standard	Normlight





01

**H3**

24V 70W PK22s

Item No.	execution	Manufacturer
3720-064-271	HD / LL	OEM quality
3723-064-151	standard	Normlight



02

**H15**

24V 60 / 20W PGJ23t-1

OEM quality

- ▶ Item no. 3720-064-275



03

**H11**

24V 70W PGJ19-2

OEM quality

- ▶ Item no. 3720-064-217



04

**D2S Xenon gas discharge lamp**

12 / 85V 35W P32d-2

- ▶ Item no. 3720-064-222
- ▶ Technical specifications
  - for projection headlights
  - approx. 4,100 Kelvin



05

**D2R Xenon gas discharge lamp**

12 / 85V 35W P32d-3

- ▶ Item no. 3720-064-223
- ▶ Technical specifications
  - for reflective headlights
  - approx. 4,000 Kelvin



06

**D1S Xenon gas discharge lamp**

12 / 85V 35W PK32d-2

- ▶ Item no. 3720-064-224
- ▶ Technical specifications
  - approx. 4,000 Kelvin
  - 3200 lumens



07

**D3S Xenon gas discharge lamp**

12 / 42V 35W PK32d-5

- ▶ Item no. 3720-064-225
- ▶ Technical specifications
  - for reflection headlights
  - approx. 4,000 Kelvin
  - 3,200 lumens

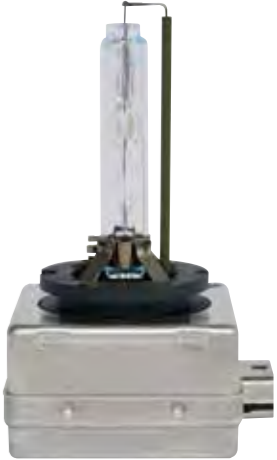

05

**D4S Xenon gas discharge lamp**

12 / 42V 35W P32d-5

- ▶ Item no. 3720-064-226
- ▶ Technical specifications
  - for reflection headlights
  - approx. 4,000 Kelvin
  - 3,200 lumens



06

**D4R Xenon gas discharge lamp**

12 / 85V 35W P32d-6

- ▶ Item no. 3720-064-227
- ▶ Technical specifications
  - for reflective headlights
  - approx. 4,000 Kelvin
  - 2,800 lumens



01

**Taillight lamp**

Base BA15s

Item No.	power	execution	Manufacturer
3720-056-27	5W	OEM quality	OEM quality
3720-752-3	5W	5W HD LL	OEM quality
3720-056-37	10W	10W	OEM quality
3720-752-5	10W	10W HD LL	OEM quality
3723-562-7	5W	HD	Normlight
3723-563-7	10W	HD	Normlight



04

**24V PY21W flashing light bulb HDLL yellow**

Base BAU15S

► Item no. 3720-752-2

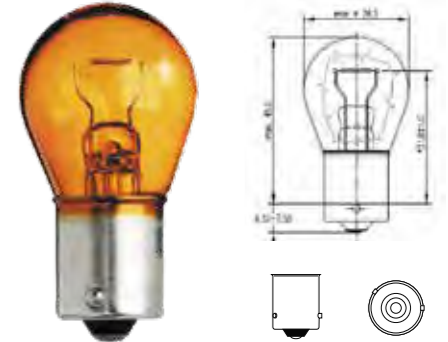

02

**24V indicator or brake light lamp**

Base BA15s

Item No.	power	execution	Manufacturer
3720-075-35	18W	OEM quality	OEM quality
3720-075-11	21W	OEM quality	OEM quality
3720-752-1	21W	21W HD LL	OEM quality
3723-075-11	21W	Normlight	Normlight
3723-751-1	21W 21W HD	Normlight	Normlight

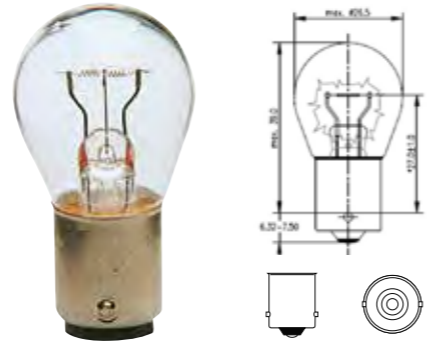

05

**Brake or tail light lamp**

24 V BAY15d

Item No.	power	execution	Manufacturer
3723-075-37	21/5W	21/5W	Normlight
3720-075-37	21/5W	21/5W	OEM quality



06

**Taillight lamp**

Base BAZ15d

► Item no. 3720-075-47



03

**Brake and tail light lamp**

Base BAY15d

Item No.	power	Manufacturer
3720-075-37	21/5W	OEM quality
3720-075-371	21/5W	OEM quality



07

**Taillight lamp**

Base BA15d

► Item no. 3720-056-26





01

**Wedge base bulb**

Base W2.1x9.5d

Item No.	power	Manufacturer
3720-028-40	2W	OEM quality
3720-028-41	3W	OEM quality
3720-028-45	5W	OEM quality
3723-028-45	5W	Normlight

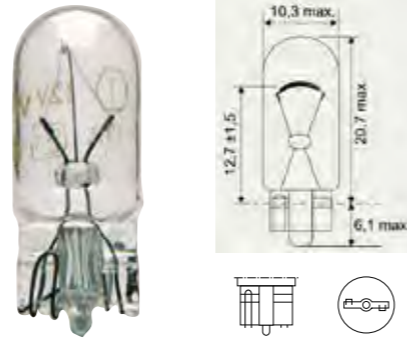

04

**Parking light lamp**

24V T4W parking light bulb HDLL

Item No.	power	execution	Manufacturer
3720-752-6	4W	4W HD LL	OEM quality
3723-393-0	4W	HD	Normlight

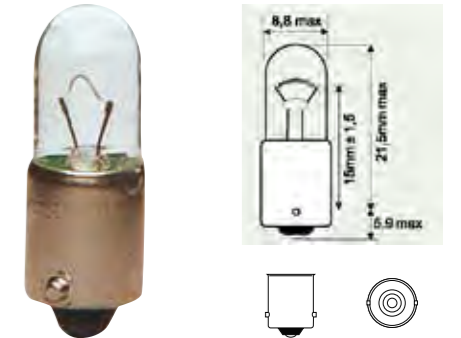

02

**Wedge base bulb**

Base W2x4.6d

► Item no. 3720-027-41

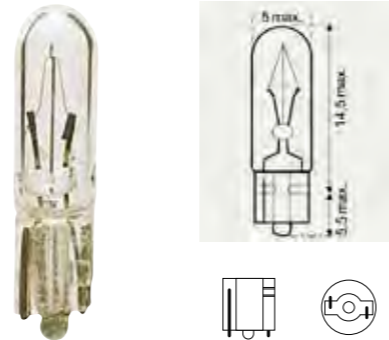

05

**24V 3W parking light and indicator lamp**

Base BA7s

► Item no. 3720-038-99



03

**24V parking light and indicator lamp**

Base BA9s

Item No.	power	Manufacturer
3720-037-97	2W	OEM quality
3720-039-30	4W	OEM quality

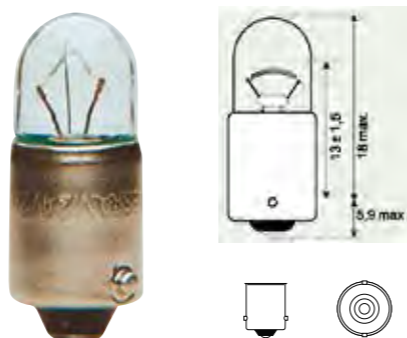

06

**24V 21W halogen flashing lamp**

Base BAY9s

► Item no. 3720-075-13



01

**Soffit lamp**

Base SV8,5-8

Item No.	power	length	Ø mm
3720-064-23	5W	35 mm	11
3720-064-24	5W	41 mm	11
3720-064-29	10W	41 mm	11
3720-064-80	18W	41 mm	15



02

**24V 5W festoon lamp**

SV8.5 socket

► Item no. 3720-064-30



03

**Plastic base lamp**

Base B8.3d gray

► Item no. 3720-027-404



04

**Plastic base lamp yellow**

24V 1.2W

► Item no. 3720-027-610

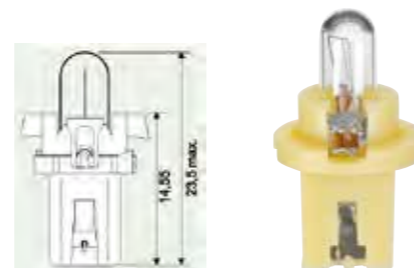

05

**Plastic base lamp yellow**

24V 1.2W

► Item no. 3720-027-605

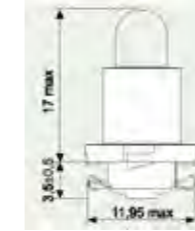

06

**Plastic base lamp green**

Base EBS R11 green

► Item no. 3720-027-420

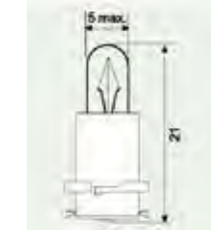

07

**Plastic base lamp grey**

Base B8.5d gray

► Item no. 3720-027-419

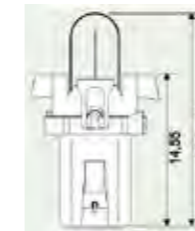

08

**Plastic base lamp brown**

Base Bx8.5d brown

► Item no. 3720-027-600

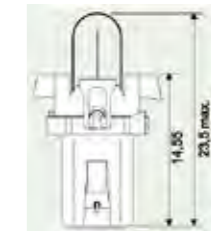

09

**Plastic base lamp white**

24V 1W

► Item no. 3720-027-606

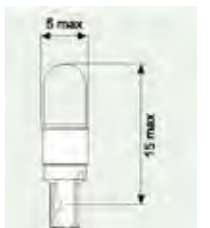

10

**Plastic base lamp white**

24V 2,4V B9

► Item no. 3720-027-603







01

**Glowpoint LED**

Base BA15s

▶ Item no. 3720-075-15

▶ Technical specifications

- up to 10,000 operating hours
- strong luminosity
- Energy and cost efficient
- break-proof housing

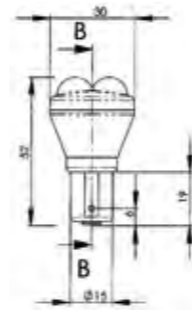

02

**Replacement light bulb**

RX-T / E 18W / 830 GX 24q-2

▶ Item no. 3720-064-230

▶ Technical specifications

- Luminous efficacy: 3000 Kelvin



03

**24V H1 / H7 commercial vehicle lamp replacement box, HDLL**

Normlight quality

▶ Item no. 3723-030

▶ Content:

- 2x plug-in fuse 10A (item no. 3731-010)
- 2x 15A plug-in fuse (item no. 3731-015)
- 2x plug-in fuse 20A (item no. 3731-020)
- 2x plug-in fuse 25A (item no. 3731-025)
- 2x parking lights 4W HD (item no. 3723-393-0)
- 2x tail lights 10W HD (item no. 3723-563-7)
- 8x indicator and brake light 21W (item no. 3723-075-11)
- 2x Soffite 8.5-8 10W (Item no. 3720-064-29)
- 1x main headlight H1 (Item no. 3723-064-155)
- 1x main headlight H7 (Item No. 3723-064-211)



04

**24V H1 / H7 commercial vehicle lamp replacement box**

18 pieces, H1 / H7 Normlight quality

▶ Item no. 3723-031

▶ Content:

- 3x plug-in fuse 10A (item no. 3731-110)
- 3x plug-in fuse 15A (item no. 3731-115)
- 2x tail lights 10W HD (item no. 3723-563-7)
- 2x tail light 5W HD (item no. 3723-562-7)
- 2x indicator or brake light bulb 21W HD (item no. 3723-751-1)
- 2x flashing light lamp yellow PY21W HDLL (item no. 3720-752-2)
- 2x main headlights H1 (item no. 3723-064-155)
- 2x main headlights H7 HDLL (item no. 3723-064-273)



05

**Spare lamp box empty**

for 12V / 24V H7 / H1

▶ Item no. 3720-03-222

▶ Technical specifications

- 18 cm x 9.5 cm x 5 cm
- transparent lid













01

**Crimp-shrink connector waterproof**

## ► Technical specifications

- Minimum shrink temperature: 100 ° C
- Continuous temperature range: -55 ° C to 125 ° C
- Shrink rate: 3: 1 / material: polyolefin
- Polyolefin shrinks 40% faster than polyamide
- Shrink temperature lower than with polyamide (100 ° C instead of 170 ° C)
- \* VW special plug

Item No.	cross-section	colour	PU	image
3555-516-0	0,1 - 0,5 mm <sup>2</sup>	white	50	
3555-516-1	0,5 - 1,5 mm <sup>2</sup>	red	50	1 
3555-516-2	1,5 - 2,5 mm <sup>2</sup>	blue	50	2 
3555-516-4	4,0 - 6,0 mm <sup>2</sup>	yellow	50	3 
3555-516-5	0,3 - 0,5 mm <sup>2</sup>	yellowish	50	

02

**Double tin solder shrink connector waterproof**

## ► Technical specifications

- Minimum shrink temperature: 140°C
- Continuous temperature range: -55°C to + 125°C
- Shrink ratio: 3:1 / material: polyolefin
- Polyolefin shrinks 40% faster than polyamide





Item No.	execution	colour	PU	image
3555-926-1	Ø 1.5 - 2.5 Length: 31 mm	red	25	
3555-926-2	Ø 2.5 - 4.0 Length: 36 mm	blue	25	
3555-926-3	Ø 4.0 - 6.0 Length: 42 mm	yellow	25	

03

**Solder butt connector**

## ► Technical specifications

- Continuous temperature resistance: -55 ° C to 125 ° C
- Melting point from 85 ° C

Item No.	execution	colour	PU	image
3555-923-0	Ø 0.3 - 0.8, Length: 26 mm	grey	50	
3555-923-1	Ø 0.8 - 2.0, Length: 42 mm	red	50	
3555-923-2	Ø 2.0 - 4.0, Length: 42 mm	blue	50	
3555-923-3	Ø 4.0 - 6.0, Length: 42 mm	yellow	25	

04

**Butt connector Y-crimp branch connector**

## ► Technical specifications

- dust- and moisture-proof connections
- transparent heat shrink tubing
- easy visual control of the connection
- slim design
- little space required
- shrink ratio of 4:1
- Wide range of applications
- Dielectric strength: 20 kV/mm
- Protection class IP: IP 67
- Temperature application range min./max.: -55 to 110 ° C
- Shrink temperature min.: 300 ° C
- Avoid local overheating of the shrink tubing!

Item No.	cross-section	colour	Packing unit	image
3555-925-1		white / red	25	
3555-925-2		red / blue	25	







01

**Heat-shrinkable tubing**

Item No.	execution	colour	PU	image
3555-901-1	M4	red	50	
3555-902-1	M5	red	50	
3555-903-1	M6	red	50	
3555-904-1	M8	red	50	
3555-904-11	M10	red	25	
3555-905-1	6,3	red	25	
3555-944-1	6,3	red	50	





02

**Crimp-shrink, waterproof 1.5 - 2.5 mm<sup>2</sup>**

Item No.	execution	colour	PU	image
3555-908-2	M4	blue	50	
3555-909-2	M5	blue	50	
3555-910-2	M6	blue	50	
3555-911-2	M8	blue	50	
3555-912-2	M10	blue	25	
3555-905-2	6,3	blue	25	
3555-945-2	6,3	blue	50	

03

**Crimp-shrink, waterproof 4.0 - 6.0 mm<sup>2</sup>**

Item No.	execution	colour	PU	image
3555-914-4	M4	yellow	25	
3555-915-4	M5	yellow	25	
3555-916-4	M6	yellow	25	
3555-917-4	M8	yellow	25	

04

**Cable connector range  
waterproof**► **Item no. 1957-555**► **Contents: 400 parts**

- 50 x heat shrink connectors red 0.5-1.5 (item no. 3555-516-1)
- 50 x heat shrink connector blue 1.5-2.5 (item no. 3555-516-2)
- 25 x heat shrink connector yellow 4.0-6.0 (item no. 3555-516-4)
- 25 x ring tongue M6 red with shrink tubing (item no. 3555-903-1)
- 25 x ring tongue M8 red with shrink tube (item no. 3555-904-1)
- 25 x ring tongue M5 blue with shrink tubing (item no. 3555-909-2)
- 25 x ring tongue M8 blue with shrink tube (item no. 3555-911-2)
- 50 x butt connector solderable red 0.5-1.5 (Art.-No. 3555-923-1)
- 50 x butt connectors solderable blue 1.5-2.5 (item no. 3555-923-2)
- 25 x butt connectors solderable yellow 3.0-6.0 (item no. 3555-923-3)
- 25 x blue flat tabs with shrink tubing (item no. 3555-945-2)
- 25 x flat receptacles blue with shrink tubing (item no. 3555-905-2)











01

**Insulated cable plugs 0.5 - 1.0 mm<sup>2</sup>**

Item No.	execution	colour	PU	image
3558-900-1	M3	red	100	
3558-901-1	M4	red	100	
3558-902-1	M5	red	100	
3558-903-1	M6	red	100	
3558-904-1	M8	red	100	
3558-960-1	2,8	red	100	
3558-960	2,8	red	100	
3558-976-1	4,8	red	100	
3558-977-1	4,8	red	100	
3558-905-1	6,3	red	100	7 
3558-905-11	6,3	red	100	9 
3558-975-1	2,8	red	100	
3558-939-1	4,8	red	100	
3558-944-1	6,3	red	100	5 
3555-951-1	0.25 - 1.0 mm <sup>2</sup>	red	50	
3558-925-1	Shock connector	red	100	





Continued

**Insulated cable plugs 0.5 - 1.0 mm<sup>2</sup>**

Item No.	execution	colour	PU	image
***???				
3558-946-1	M4	red	100	
3558-947-1	M4	red	100	
3558-942-1	6,3	red	100	
3558-950-1	isolated	red	100	
3558-955-1	M4	red	50	
3558-954-1	M5	red	50	

02

**Insulated cable plugs 1.0 - 2.5 mm<sup>2</sup>**

Item No.	execution	colour	PU	image
3558-907-2	M3,5	blue	100	
3558-908-2	M4	blue	100	
3558-909-2	M5	blue	100	
3558-910-2	M6	blue	100	
3558-911-2		blue	100	
3558-976-2	4,8	blue	100	
3558-905-2	6,3	blue	100	4 

Continued

**Insulated cable plugs 1.0 - 2.5 mm<sup>2</sup>**

***???				
3558-940-2	8,2 x 0,8	blue	100	
3558-939-2	4,8	blue	100	
3558-945-2	6,3	blue	100	6 
3558-905-22	6,3	blue	100	8 
3558-926-2	Shock connector	blue	100	
3558-948-2	M5	blue	100	
3558-949-2	M5	blue	100	
3558-943-2	6,3	blue	100	
3558-951-2	Wire pin sleeves	blue	100	
3558-953-2	M4	blue	50	
3558-954-2	M5	blue	50	

01

**Insulated cable plugs 4.0 - 6.0 mm<sup>2</sup>**

Item No.	execution	colour	PU	image
3558-914-4	M4	yellow	100	
3558-915-4	M5	yellow	100	
3558-916-4	M6	yellow	100	
3558-917-4	M8	yellow	100	
3558-918-4	M10	yellow	100	
3558-905-4	6,3	yellow	100	
3558-941-4	9,5	yellow	100	
3558-927-4	Shock connector	yellow	100	
3558-961	M5	yellow	50	
3558-962	M5	yellow	50	
3558-952-4	Wire pin sleeves	yellow	50	
3558-921-4	M4	yellow	50	
3558-956-4	6,3	yellow	100	
3558-906-4	6,3	yellow	100	





01

### Cable connector range isolated













► Item no. 1957-558-1

► Contents: 530 parts

- 20 x cable quick connector blue (item no. 3555-564)
- 25 x ring tongue M4 red (Art.-No. 3558-901-1)
- 50 x red flat receptacles (Item No. 3558-905-1)
- 100 x flat receptacle blue (Item No. 3558-905-2)
- 50 x yellow flat receptacles (item no. 3558-905-4)
- 25 x ring tongues M4 blue (item no. 3558-908-2)
- 25 x ring tongue M5 blue (item no. 3558-909-2)
- 25 x ring tongue M6 blue (item no. 3558-910-2)
- 25 x ring tongue M6 yellow (Art.-No. 3558-916-4)
- 25 x butt connector red (item no. 3558-925-1)
- 25 x butt connectors blue (item no. 3558-926-2)
- 25 x double flat plugs blue (item no. 3558-943-2)
- 25 x flat tabs 6.3mm red (Item No. 3558-944-1)
- 25 x flat tabs 6.3mm blue (item no. 3558-945-2)
- 15 x round plugs red (Item No. 3558-946-1)
- 15 x round socket red (Item No. 3558-947-1)
- 15 x round plugs blue (item no. 3558-948-2)
- 15 x round socket blue (item no. 3558-949-2)

02

### Cable quick connector

Item No.	cross-section	colour	PU	image
3555-951	0,25 - 1,0 mm <sup>2</sup>	red	50	
3555-951-1	0,25 - 1,0 mm <sup>2</sup>	red	50	
3555-952	2,5 - 4,0 mm <sup>2</sup>	blue	50	
3555-952-1	1,0 - 2,5 mm <sup>2</sup>	blue	50	
3555-953	4,0 - 6,0 mm <sup>2</sup>	yellow	50	
3555-953-1	4,0 - 6,0 mm <sup>2</sup>	yellow	50	
3555-557	0,4 - 1,0 mm <sup>2</sup>	red	50	
3555-557-1	0,2 - 1,5mm <sup>2</sup>	red	100	
3555-564	1,0 - 2,5 mm <sup>2</sup>	blue	100	
3555-564-1	1,5 - 2,5 mm <sup>2</sup>	white	50	
3555-562-1	1,5 - 4,0 mm <sup>2</sup>	brown	50	
3555-562	2,5 - 4,0 mm <sup>2</sup>	yellow	50	



01

**3-way flat branch**  
transparent

► Item no. 3555-11

► Technical specifications

- 3-way
- for flat receptacles with 6.3 mm plug width
- max. voltage 300 V
- Dimensions 54 mm x 21 mm



02

**4-way flat branch**  
transparent

► Item no. 3555-12

► Technical specifications

- 4-way
- for flat receptacles with 6.3 mm plug width
- max. voltage 300 V
- Dimensions 54 mm x 21 mm



03

**Flat pin terminal boards**

Flat receptacle with 6.3 mm plug width, max.voltage: 300 V



Item No.	execution	dimension	PU
3555-2	short conductor insulation	125 x 25,8 mm	10
3555-4	long conductor insulation	144 x 48,0 mm	10

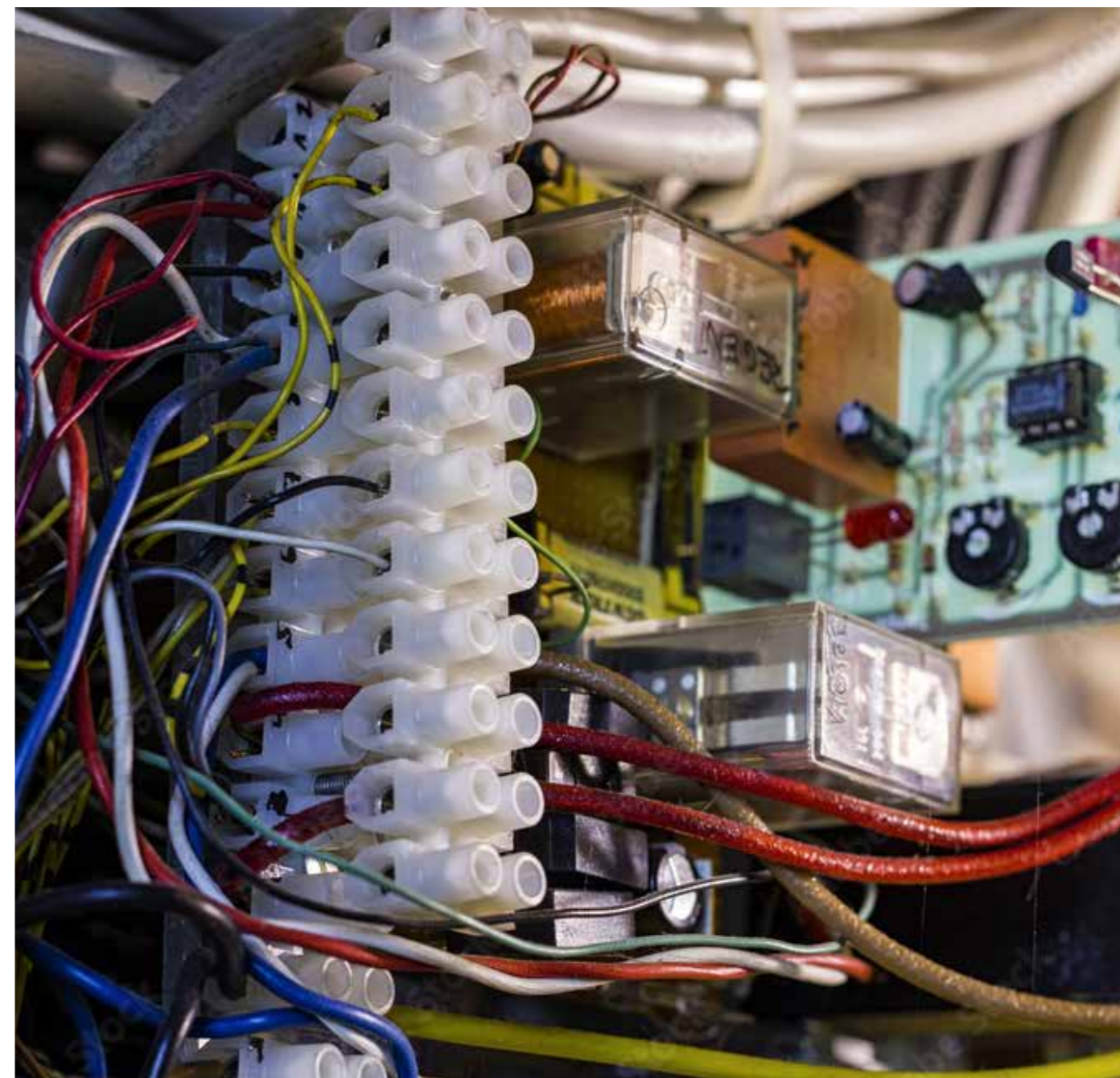

04

**Luster terminals**

► Technical specifications

- Series of 12
- CE mark
- plastic and metal
- With double screw terminal for secure connections

















Item No.	cross-section	nominal voltage	PU
3556-1	1,0 - 4,0 mm <sup>2</sup>	32 A	10
3556-2	1,5 - 6,0 mm <sup>2</sup>	41 A	10



01

**Flat receptacles universal**





Item No.	Plug dimension	cross-section	execution	Type	PU	image
3558-513-5	6,3	0,5 - 1,0 mm <sup>2</sup>	pre-rolled - with hole	MVZ	100	
3558-601-0	2.8 x 0.8	0,5 - 1,0 mm <sup>2</sup>	0.5 – 1.0 with notch pre-rolled	MVZ	100	
3558-531-2	4.8 x 0.8	1,5 - 2,5 mm <sup>2</sup>	scrolled up	MVZ	100	
3558-631-2	4.8 x 0.8	1,5 - 2,5 mm <sup>2</sup>	1.5 – 2.5 with notch	MBL	100	
3558-991-6	6.3 x 0.8	0,5 - 1,0 mm <sup>2</sup>	0.50 – 1.0 with notch pre-rolled	MVZ	50	
3558-504-0	6.3 x 0.8	0,5 - 1,0	0.50 – 1.0 with notch pre-rolled	MBL	100	
3558-992-8	6.3 x 0.8	1,5 - 2,5 mm <sup>2</sup>	1.5 – 2.0 with notch pre-rolled	MSI	50	
3558-929	6.3 x 0.8	1,5 - 2,5 mm <sup>2</sup>	1.50 – 2.5 pre-rolled	MBL	100	
3558-603-2	6.3 x 0.8	1,5 - 2,5 mm <sup>2</sup>	1.50 – 2.5 with notch pre-rolled	MBL	100	
3558-991-7	6.3 x 0.8	1,5 - 2,5 mm <sup>2</sup>	1.50 – 2.5 with notch pre-rolled	MVZ	50	
3558-504-7	6.3 x 0.8	4,0 - 6,0 mm <sup>2</sup>	4.0 – 6.0 with notch pre-rolled	MBL	100	
3558-996-2	6.3 x 0.8	4,0 - 6,0 mm <sup>2</sup>	4.0 – 6.0 with notch pre-rolled	MVZ	100	
3558-992-6	6.3 x 0.8	4,0 - 6,0 mm <sup>2</sup>	4.0 – 6.0 with notch pre-rolled	MSI	50	
3558-502-0	7.7 x 0.8	1,0 - 2,0 mm <sup>2</sup>	with notch	MBL	100	
3558-526-6	9.5 x 1.2	4,0 - 6,0 mm <sup>2</sup>	scrolled up	MBL	100	

Legend

MBL = bright brass MVZ = tinned brass BVZ = tinned bronze MSI =



Continued

**Flat receptacles universal**

Item No.	Plug dimension	cross-section	execution	Type	PU	image
3558-526-7	9.5 x 1.2	4,0 - 6,0 mm <sup>2</sup>	4.0 – 6.0 with notch	MVZ	100	
3558-87-1	Ø 0.35 - 0.50	0,35 - 0,5 mm <sup>2</sup>	uninsulated		100	
3558-87-2	Ø 0.75 - 1.50	0,75 - 1,5 mm <sup>2</sup>	uninsulated		100	
3558-87-3		1,5 - 2,5 mm <sup>2</sup>	uninsulated		100	



02

**Flat receptacle with locking device**

Item No.	Plug dimension	cross-section	execution	Type	PU	image
3558-160-77	6.3 x 0.8	0,5 - 1,5 mm <sup>2</sup>	with catch - pre-rolled		100	
3558-160-78	6.3 x 0.8	1,5 - 2,5 mm <sup>2</sup>	with catch - pre-rolled		100	
3558-160-79	6.3 x 0.8	4,0 - 6,0 mm <sup>2</sup>	with catch - pre-rolled		100	

03









**Butt connector with crimp connection**

Item No.	cross-section	PU	image
3555-924-1	0,2 - 0,35 mm <sup>2</sup>	100	
3555-924-2	0,5 - 1,0 mm <sup>2</sup>	100	
3555-924-3	1,5 - 2,5 mm <sup>2</sup>	100	

silver brass BBL = bright bronze VGK = gold-plated edges

01

**Flat tabs universal**

Item No.	Plug dimension [mm]	cross-section	execution	Type	PU	image
						
3558-87-21		0,75 - 1,5 mm <sup>2</sup>	uninsulated		100	
3558-514-4	2,8	0,5 - 1,0 mm <sup>2</sup>	with hole	BVZ	100	
3558-996-0	6,3	0,5 - 1,0 mm <sup>2</sup>	with notch pre-rolled – with hole	MVZ	100	
3558-993-7	6,3	0,5 - 1,0 mm <sup>2</sup>	with notch pre-rolled – with hole	MSI	50	
3558-501-9	6,3	1,0 - 2,5 mm <sup>2</sup>	pre-rolled – with hole	MBL	100	
3558-505-41	2,8	1,5 - 2,5 mm <sup>2</sup>	with notch – with hole	BVZ	100	
3558-505-4	6,3	1,5 - 2,5 mm <sup>2</sup>	with notch pre-rolled – with hole	MBL	100	
3558-991-8	6,3	1,5 - 2,5 mm <sup>2</sup>	with notch pre-rolled – with hole	MVZ	50	
3558-993-5	6,3	1,5 - 2,5 mm <sup>2</sup>	with notch pre-rolled – with hole	MSI	100	
3558-996-3	6,3	4,0 - 6,0 mm <sup>2</sup>	with notch – with hole	MVZ	50	
3558-87-11	6,3	0,35 - 0,5 mm <sup>2</sup>	with hole		100	
3558-87-31	6,3	1,5 - 2,5 mm <sup>2</sup>	with notch + hole, pre-rolled		100	
						



02

**Angular blade receptacles universal**

Item No.	Plug dimension	cross-section	execution	Type	PU	image
3558-994-1	6.3 x 0.8	1,5 - 2,5 mm <sup>2</sup>	scrolled up	MBL	50	





03

**Angular blade receptacles universal**

Item No.	cross-section	PU	image
3558-928		100	
3558-514-3	0,5 - 1,0 mm <sup>2</sup>	100	

04



**Cable lugs**

Item No.	execution	Material	PU	image
3558-521-5	1.5 - 2.5 M4	MBL	100	
3558-521-7	1.5 - 2.5 M5	MVZ	100	
3558-521-9	1.5 - 2.5 M6	MVZ	100	
3558-522-1	1.5 - 2.5 M8	MBL	100	











01

**Flat tongue**

Item No.	Plug dimension	Eyelet Ø:	execution	Type	PU	image
3558-160-61	6.3 x 0.8	M5	with hole	MVZ	100	
3558-173-0	6.3 x 0.8	M6	With MBL hole	MBL	100	





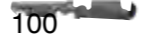





02

**Special plugs**

Item No.	Plug dimension	cross-section	execution	Type	PU	image
3558-997-23	4,8	1,0 - 2,5 mm <sup>2</sup>	Flat spring connector	997-23	50	
3558-997-2	4,8	0,5 - 1,0 mm <sup>2</sup>	Flat spring connector	3558-997-2	100	
3558-996-7	2,8	0,5 - 1,0 mm <sup>2</sup>	Flat spring connector	3558-996-7	50	
3558-996-9	2,8	1,5 - 2,5 mm <sup>2</sup>	Flat spring connector	3558-996-9	50	
3558-991-16	2,8	1,5 - 2,5 mm <sup>2</sup>	Flat spring connector	3558-991-16	50	
3558-997-3	4,8	1,5 - 2,5 mm <sup>2</sup>	Flat spring connector	3558-997-3	100	
3558-997-31	4,8	1,5 - 2,5 mm <sup>2</sup>	Flat spring connector	3558-997-31	50	
3558-990-9		0,5 - 1,5 mm <sup>2</sup>	Flat spring connector	3558-990-9	50	
3558-992-4	2,8	0,5 - 1,0 mm <sup>2</sup>	Flat tongue	3558-992-4	50	
3558-998-1		0,5 - 0,75 mm <sup>2</sup>	0.5 - 0.75	3558-998-1	100	

Continued

**Special plugs**









Item No.	Plug dimension	cross-section	execution	Type	PU	image
3558-997-0	1.5	0,5 - 1,0 mm <sup>2</sup>	Round connector	3558-997-0	50	
3558-997-1	1.5	1,5 - 2,5 mm <sup>2</sup>	Round connector	3558-997-1	50	
3558-990-7	1.5	0,75 - 1,5 mm <sup>2</sup>	Round connector	3558-990-7	50	
3558-990-6	2.1	1,0 - 2,5 mm <sup>2</sup>	Round connector	3558-990-6	50	
3558-990-2	3.5	0,5 - 2,5 mm <sup>2</sup>	Round connector	3558-990-2	50	
3558-513-3	4	1,5 - 2,5 mm <sup>2</sup>	Round connector	3558-513-3	100	
3558-996-4	1.5	0,5 - 1,0 mm <sup>2</sup>	Round socket	3558-996-4	50	
3558-990-8	1.5	0,75 - 1,5 mm <sup>2</sup>	Round socket	3558-990-8	50	
3558-993-1	2.1	0,5 - 1,0 mm <sup>2</sup>	Round socket	3558-993-1	50	
3558-990-1	3.5	0,5 - 2,5 mm <sup>2</sup>	Round socket	3558-990-1	50	
3558-997-6	3.5	1,5 - 2,5 mm <sup>2</sup>	Round socket	3558-997-6	50	

Legend

MBL = bright brass MVZ = tinned brass BVZ = tinned bronze MSI =

silver brass BBL = bright bronze VGK = gold-plated edges

01  
VW special connector

Item No.	Plug dimension	cross-section	Original no.	PU	image
3558-102-116		0,5 - 1,0 mm <sup>2</sup>	N102-116-06	25	
3558-102-117		0,5 - 1,0 mm <sup>2</sup>	N102-117-03	25	
3558-904-886		0,5 - 1,0 mm <sup>2</sup>	N904-886-04	25	
3558-990-91	2,5 mm	0,5 - 1,0 mm <sup>2</sup>		25	
3558-991-151	2,8/4,8 x 0,8 mm	0,5 - 1,0 mm <sup>2</sup>		25	
3558-904-218		0,5 - 1,0 mm <sup>2</sup>	N904-218-02	25	
3558-904-887		1,5 - 2,5 mm <sup>2</sup>	N904-887-03	25	
3558-904-220		2,5 - 4,0 mm <sup>2</sup>	N904-220-02	25	

02  
Multiple connector shell  
for flat tabs

Item No.	Plug-in connections No./Fig.	PU	image
3555-100-1	1 / -	10	1
3555-100-2	2 / =	10	2
3555-100-22	2 /   -	10	3
3555-100-4	4 / = =	10	4
3555-100-6	6 / = = =	10	5
3555-100-8	8 / = = = =	10	6



03  
Multiple connector shell  
for flat receptacles

Item No.	Plug-in connections No./Fig.	PU	image
3555-100-11	1 / -	10	1
3555-100-21	2 / =	10	2
3555-100-23	2 /   -	10	3
3555-100-41	4 / = =	10	4
3555-100-61	6 / = = =	10	5
3555-100-81	8 / = = = =	10	6











01

**Receiving housing**







waterproof, black

Item No.	connection	PU	image
3558-81-1	1 time	5	
3558-82-1	2 times	5	
3558-83-1	3 times	5	
3558-84-1	4 times	5	
3558-85-1	5-fold	5	
3558-86-1	6 times	5	

02

**Locking housing for waterproof plug-in system AMP**

waterproof, black

Item No.	connection	PU	image
3558-81	1 time	5	
3558-82	2 times	5	
3558-83	3 times	5	
3558-84	4 times	5	
3558-85	5-fold	5	
3558-86	6 times	5	





03

**Sealing plug for housing and locking housing**

## ► Technical specifications

- Temperature resistance: -30°C to +105°C

- Material: silicone

Item No.	Ø cable	colour	PU	image
3558-88-1	0,35 - 0,50 mm	orange	100	
3558-88-2	0,75 - 1,50 mm	yellow	100	
3558-88-3	1,50 - 2,50 mm	red	100	
3558-88-4	3,4 mm	red	100	

04

**Wire end ferrule**

tinned uninsulated

Item No.	cross-section	Length [mm]	PU
3557-184-189	0,5 mm <sup>2</sup>	6	100
3557-184-177	0,75 mm <sup>2</sup>	6	100
3557-175-916	1,0 mm <sup>2</sup>	6	100
3557-175-928	1,5 mm <sup>2</sup>	7	100
3557-184-191	2,5 mm <sup>2</sup>	7	100
3557-184-098	4,0 mm <sup>2</sup>	12	100



05

**AMP connector, T-piece**

3-way distributor, 2-pole

## ► Item no. 3558-890

## ► Technical specifications

- for 2-pole contacts (article no. 3558-82)





01

**Insulated wire end ferrules**

- Technical specifications
- Temperature range: -35 ° C to 105 ° C
- Introductory bar: polypropylene
- galvanized, tinned

Item No.	cross-section	colour	PU	image
3557-000-50	0,5 mm <sup>2</sup>	orange	100	
3557-000-75	0,75 mm <sup>2</sup>	white	100	
3557-001-00	1,0 mm <sup>2</sup>	yellow	100	
3557-001-50	1,5 mm <sup>2</sup>	red	100	
3557-002-50	2,5 mm <sup>2</sup>	blue	100	
3557-004-00	4,0 mm <sup>2</sup>	grey	100	
3557-006-00	6,0 mm <sup>2</sup>	black	100	

02

**Crimping pliers set 5 in 1**

with 5 interchangeable die heads, automatic lock, 2-K handle insulation

► Item no. 8558-100

- Technical specifications
- Pliers for all occasions
- Simply replace the dies
- Ball bearings ensure optimal hold of the die
- Gas-free pressing is possible when repairing gas installations
- Includes practical case



**OVERVIEW OF DIES/JAWS**

**Die A:**  
Die for insulated cable lugs 0.5 mm - 6.0 mm  
Cable: flexible, cross-section 0.5 - 6.0 mm

**Die B:**  
Die for non-insulated cable lugs 0.5 mm - 10.0 mm  
Ideal for non-insulated contacts with closed surface,  
Suitable for eyelet lugs, terminal pins, joint connectors  
and small cable lugs  
Cable: flexible, cross-section 0.5 - 10.0 mm

**Die C:**  
Die for blade terminal 0.5 mm - 6.0 mm,  
up to 6.3 mm wide

**Die D:**  
Die for ferrules 0.5 mm - 4.0 mm  
Cable: flexible, cross-section 0.5 - 4.0 mm

**Die E:**  
Die for ferrules 6.0 mm - 16.0 mm  
Cable: flexible, cross-section 6.0 - 16.0 mm





01

**Waterproof plug-in housing range**

waterproof, vibration-proof

► Item no. 1957-560

## ► Content:

- 4 x lock housing with 2-way seal (item no. 3558-82)
- 4 x lock housing with 3-way seal (item no. 3558-83)
- 4 x lock housing with 4-way seal (item no. 3558-84)
- 4 x lock housing with 5-way seal (item no. 3558-85)
- 4 x lock housing with 6-way seal (item no. 3558-86)
- 
- 4 x housing 2-way (item no. 3558-82-1)
- 4 x 3-way housing (item no. 3558-83-1)
- 4 x receiving housing 4-way (item no. 3558-84-1)
- 4 x receiving housing 5-way (item no. 3558-85-1)
- 4 x 6-way housing (item no. 3558-86-1)
- 
- 100 x flat receptacles 0.75 - 1.5 (item no. 3558-87-2)
- 100 x flat receptacles 0.75 - 1.5 (item no. 3558-87-21)
- 100 x sealing plugs yellow 0.75 - 1.5 (item no. 3558-88-2)
- 100 x sealing plugs red 1.5 - 2.5 (item no. 3558-88-3)

02

**Digital clamp ammeter**

TESTBOY TV 216N

► Item no. 8715-64-585

## ► Technical specifications

- Wide range of functions
- easy to read LCD
- LED measuring point illumination
- Non-contact measurement of frequencies and sampling rate
- T-RMS measuring method for non-sinusoidal voltages



03

**Test lamp**

6 V - 24 V.

► Item no. 8715-64-60



05

**Replacement lamp for 8715-64-60**

6 V - 24V

► Item no. 3720-900-3



04

**Voltage tester**

3V - 48V

► Item no. 8715-64-59





01

**Digital Multimeter MM 7-1 BENNING**

with maximum security for industrial applications

► Item no. 8715-64-583

► Technical specifications

- automatic AC / DC voltage detection
- automatic stray voltage suppression (Lo - Z)
- True RMS measurement
- integrated and non-contact voltage sensor CAT III 1000 V; CAT III 1000 V
- 
- Measuring range V / DC max.: 1000 V
- Measuring range V / AC max.: 1000 V
- Measuring range capacity: 0.001  $\mu$  - F - 10 m - Group- Article - IDs: 123057, 1237694
- Measuring range A / DC max.: 10 A
- Measuring range A / AC max.: 10 A.
- Measuring range A / DC min.: 0.01 m
- Measuring range A / AC min.: 0.01 m
- Voltage measurement: AC / DC.
- Power supply: 9 V block
- Measuring range A / AC: 0.01 m
- Measuring range A / DC: 0.01 m
- Measuring range V / DC min.: 0.01 m
- Equipment: Auto-Range Auto-Power-Off
- Measurement functions: voltage, resistance, current, frequency, capacitance, temperature. Automatic AC / DC identification. Stray voltage suppression. Background lighting. Min / Max / Hold function. Frequency range: 50 Hz - 500 Hz
- Frequency measuring range: 0.01 Hz - 100 k - Hz
- Measuring range V / AC min.: 0.01 m -
- Temperature: -40 to 400 ° C.



02

**Multimeter**

with voltage sensor and LED torch

► Item no. 8715-64-581

► Technical specifications

- DC voltage: 2, 20, 200, 400 V
- AC voltage: 200, 400 V
- DC current: 4 amps
- AC current: 4 amps
- Operating temperature range: 0 ° C to 40 ° C
- Storage temperature range: -10 to 50 ° C?
- Functions:
- non-contact voltage test in the range 100-600V AC
- Diode test
- Auto power off function (after 15 minutes)
- white LED flashlight integrated
- Dimensions: 140 x 70 x 35mm
- Weight: 250g including batteries
- IEC / EN 61010-1
- with two glass fuses



03

**Test lead set for multimeter  
CAT III**

► Item no. 8715-64-584

► Technical specifications

- Spare part for our multimeter (item no.8715-64-581)





01

**Cable straps**

with plastic tongue

## ► Technical specifications

- Temperature range: -40 ° C to 85 ° C
- Material: polyamide 6.6
- silicone free



Item No.	Width (mm)	Length [mm]	colour	Load capacity in Nm	PU
3502-11	2,5	98	natural	80	100
3502-111	2,5	98	black	80	100
3502-12	3,6	140	natural	180	100
3502-121	3,6	140	black	180	100
3502-13	3,6	200	natural	180	100
3502-131	3,5	200	black	180	100
3502-135	3,6	290	natural	180	100
3502-135-1	3,6	290	black	180	100
3502-151	4,8	280	black	220	100
3502-14	4,8	178	natural	220	100
3502-141	4,8	178	black	220	100
3502-15	4,8	280	natural	220	100
3502-16	4,8	350	natural	220	100
3502-161	4,8	350	black	220	100
3502-165-1	4,8	500	Black	220	100
3502-171	7,6	200	black	550	100
3502-18	7,6	360	natural	550	100
3502-181	7,6	360	black	550	100
3502-191	9,0	762	black	800	100
3502-185-1	8,0	550	Black	600	100

02

**Cable tie set, small**

1,800 black cable ties with plastic tongues, 6 different sizes

## ► Item no. 3502-001

## ► Contents:

- 1,800 black cable ties with plastic tongues
- 300 pieces each in the following sizes:
  - 2.5mm x 98mm (Item No. 3502-111)
  - 3.5mm x 140mm (Item No. 3502-121)
  - 3.5mm x 200mm (Item No. 3502-131)
  - 3.6mm x 290mm (Item No. 3502-135-1)
  - 4.5mm x 178mm (Item No. 3502-141)
  - 4.5mm x 280mm (Item No. 3502-151)

03

**Cable tie set large**

1,000 black cable ties with plastic tongues, 6 different sizes

## ► Item no. 3502-002

## ► Contents:

- 1,000 black cable ties with plastic tongues
- 300 pieces each in the following sizes:
  - 
  - 4.5mm x 350mm (Item No. 3502-161)
  - 7.6mm x 200mm (Item No. 3502-171)
  - 7.5mm x 360mm (Item No. 3502-181)
  -
- 100 pieces in the following size:
  - 7.8mm x 750mm (Item No. 3502-191)



01

**Colored cable ties**

## ► Technical specifications

- with plastic tongue
- Dimensions: 282x4.8 mm
- Load capacity in N: 220
- Material: polyamide 6.6, halogen-free, silicone-free
- Temperature resistance: -40 ° C to 85 ° C
- Flammability class: UL 94 V-2

Item No.	colour	PU
3502-401	red	100
3502-402	blue	100
3502-403	yellow	100
3502-404	green	100
3502-405	white	100
3502-406	orange	100
3502-407	Gray	100
3502-408	brown	100



02

**Adhesive base for cables**  
self-adhesive

Item No.	colour	for cable bandwidth	PU
3502-71	natural	5,0 mm	25
3502-72	natural	8,0 mm	25
3502-73	natural	16,0 mm	25



03

**Cable ties**

with metal tongue, UV-resistant

## ► Technical specifications

- Temperature resistance: -40 ° C to 85 ° C
- Material: polyamide 6.6
- silicone free

Item No.	Width (mm)	Length [mm]	colour	Load capacity in Nm	PU
3502-211	2,4	92	black	80	100
3502-221	3,6	140	black	180	100
3502-201	3,6	208	black	220	100
3502-231	4,8	186	black	220	100
3502-241-0	4,8	360	black	220	100
3502-251-0	7,6	338	black	540	50



04

**Cable ties**

detachable, UV-resistant

## ► Technical specifications

- Temperature resistance: up to 85 ° C
- Material: polyamide 6.6

Item No.	Width (mm)	Length [mm]	colour	Load capacity in Nm	PU
3502-341-0	4,6	275	black	222	100
3502-351-0	7,6	376	black	334	100



05

**Adhesive base for cable ties**  
self-adhesive







Item No.	colour	for cable bandwidth	PU
3502-636	natural	3,6 mm	25
3502-648	natural	4,8 mm	25
3502-649	black	4,8 mm	25
3502-665	natural	7,8 mm	25











01

**Socket housing**

Item No.	execution	PU	image
3558-89	2 pole	10	
3558-891	3 pole	10	
3558-892	4 pole	10	
3558-893	6 pole	10	
3558-894	8 pole	10	
3558-895	12 pole	10	







02

**Socket contact protection**

Item No.	execution	Packing unit	image
3558-910	2 pole	100	
3558-911	3 pole	100	
3558-912	4 pole	100	
3558-913	6 pole	100	
3558-914	8 pole	100	
3558-915	12 pole	100	

03

**Pin housing**

Item No.	execution	Packing unit	image
3558-900	2 pole	10	
3558-901	3 pole	10	
3558-902	4 pole	10	
3558-903	6 pole	10	
3558-904	8 pole	10	
3558-905	12 pole	10	

04

**Pin contact fuse**

Item No.	execution	Packing unit	image
3558-920	2 pole	100	
3558-921	3 pole	100	
3558-922	4 pole	100	
3558-923	6 pole	100	
3558-924	8 pole	100	
3558-925	12 pole	100	

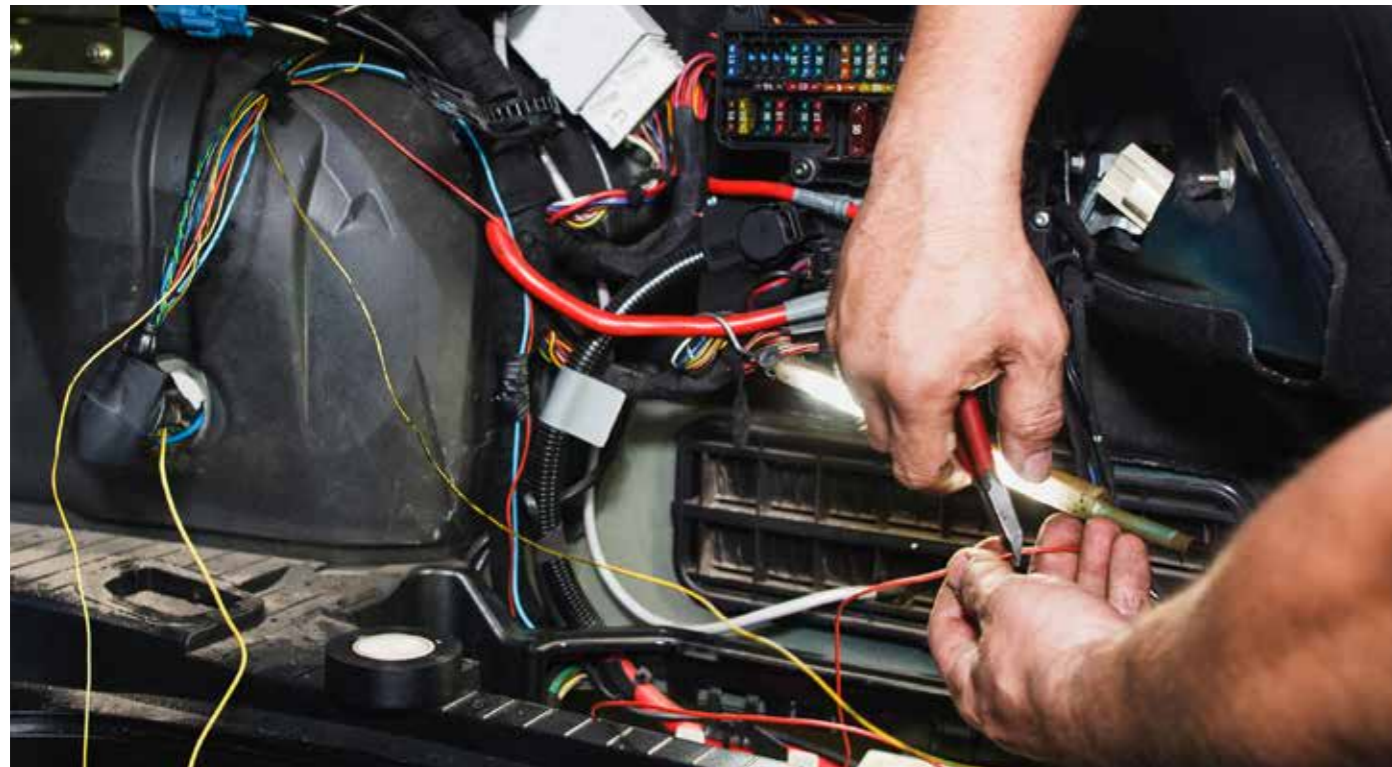

01  
**Turned socket contact**

Item No.	execution	PU	image
3558-940	0,5-1,5 mm	50	
3558-941	2,0 mm	50	

02  
**DT turned pin contact, Deutsch connector**

Item No.	execution	PU	image
3558-950	0,5-1,5 mm	50	
3558-951	2,0 mm	50	

03  
**DT sealing plug, Deutsch plug**

► Item no. 3558-930



04  
**Crimping pliers set for DT 6 in 1**  
for German plug

► Item no. 8558-106

- Contents of the case:
- Pliers
  - 6 dies
  - Die K1 AWG 14/12 for the DT P series
  - Die K2 AWG 10/12 5 / 6mm<sup>2</sup> for the DT P series
  - Die K3 AWG 18/16/14 for the DT P series
  - Die K4 AWG 20/18/16 for the DT P series
  - Die K5 AWG 20 / 18-16 for the DT P series
  - Die K6 AWG 16/14/12 for the DT P series

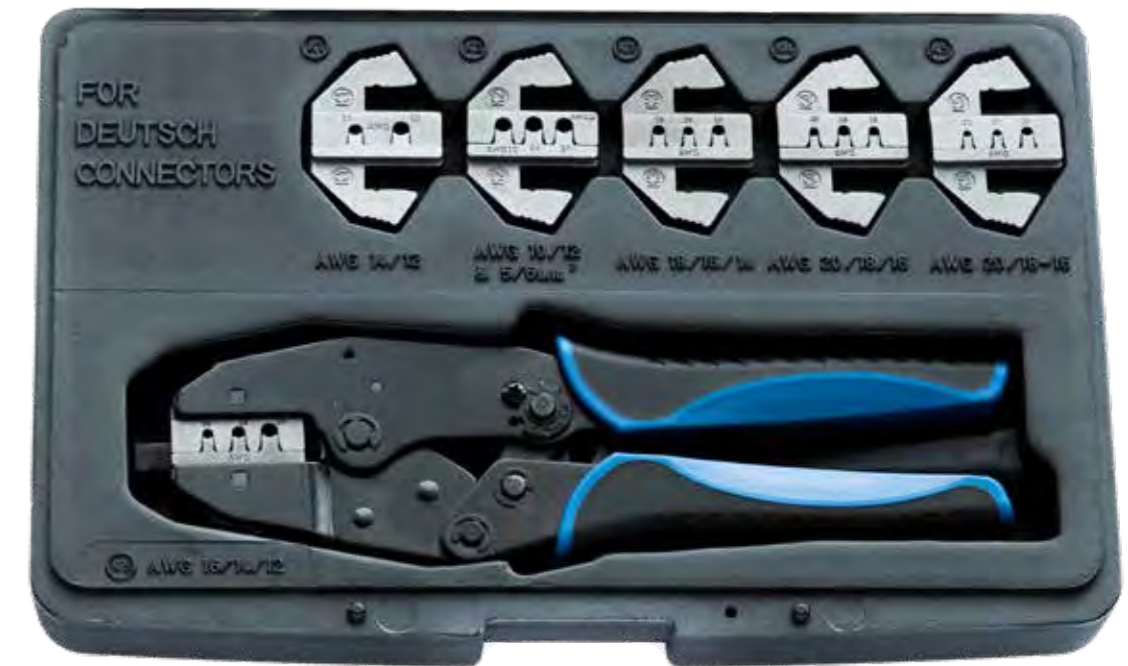

05  
**Die for insulated connections**  
Plug 0.1 - 1.5 mm

► Item no. 8558-100-13



06  
**Die for uninsulated connections**  
Plug 0.1 - 1.0 mm

► Item no. 8558-100-14





01

**electrical tape**

Adjustable and replaceable blade  
Blade mounted in metal guide  
Blade can be locked in position

## ► Technical specifications

- PVC film with acrylate
- with VDE approval mark
- meets the requirements of DIN EN 60454 type 10
- hardly inflammable
- excellent aging resistance
- pliable, soft film
- temperature resistant
- DIN EN 60 454-3-1 / F-PVC / 105 / A-Tx type 11

Item No.	colour	PU	Quantity per box
3985-10-15	black	10	100
3985-10-16	red	10	100
3985-10-17	yellow	10	100



02

**Insulating tape extra wide**

black, 10 mx 30 mm

## ► Item no. 3985-10-18

## ► Technical specifications

- PVC film with acrylate
- with VDE test mark
- meets the requirements of DIN EN 60454 type 10
- flame retardant
- excellent ageing resistance
- flexible, soft film
- resistant to alternating temperatures
- DIN EN 60 454-3-1 / F-PVC/105/A-Tx type 11



03

**Self-amalgamating tape**

10 mx 19 mm

## ► Item no. 3985-5

## ► Technical specifications

- water resistant
- high elasticity
- Processing temperature: 5 ° C to 35 ° C
- temperature resistant: -40 ° C to 90 ° C



04

**Textile tape**

25 mx 19 mm, black

## ► Item no. 3985-3

## ► Technical specifications

- rot-proof
- abrasion resistant
- noise dampening
- supple
- tearable
- aging resistant
- adhesive
- temperature resistant: up to 150 ° C



05

**Duct tape**

Length: 50 m

## ► Technical specifications

- textile reinforced
- high tensile strength
- very good adhesive strength



Item No.	Width:	Colour:	PU	Quantity per box
4992-390	38 mm	black	1	24
4992-380	38 mm	silver	1	24
4992-370	50 mm	black	1	24
4992-360	50 mm	silver	1	24

01

**Shrink tube rod**

coated with glue

## ► Technical specifications

- Shrink rate: 3: 1
- Shrink temperature: 110 ° C
- Continuous temperature resistance: -55 ° C to 110 ° C



Item No.	Ø before shrinking	Ø after shrinking	Rod length	packaging
3771-000-031	3,2 mm	1,0 mm	60 cm	10 rods
3771-000-062	6,4 mm	2,0 mm	60 cm	10 rods
3771-000-124	12,7 mm	4,0 mm	60 cm	4 rods
3771-000-248	25,4 mm	8,0 mm	60 cm	4 rods

02

**Shrink tubing pieces**

Length: 10 cm

## ► Technical specifications

- Shrink rate: 2: 1
- Shrink temperature: from 90 ° C
- Continuous temperature resistance: -55 ° C to 135 ° C
- Approval: UL 224



Item No.	Ø before shrinking	Ø after shrinking	Rod length	packaging
3771-200-24	2,4 mm	1,2 mm	10 cm	25 rods
3771-200-32	3,2 mm	1,6 mm	10 cm	25 rods
3771-200-48	4,8 mm	2,4 mm	10 cm	25 rods
3771-200-64	6,4 mm	3,2 mm	10 cm	25 rods
3771-200-95	9,5 mm	4,7 mm	10 cm	25 rods
3771-200-127	12,7 mm	6,4 mm	10 cm	25 rods
3771-200-190	19,0 mm	9,5 mm	10 cm	25 rods
3771-200-254	25,4 mm	12,7 mm	10 cm	25 rods



03

**Shrink tubing assortment**

black

## ► Item no. 1957-570

## ► Content:

- Length per piece: 10 cm
- Shrink rate 2: 1
- Contents: 125 parts
- 25 x 2.4mm / 1.2mm (Item No. 3771-200-24)
- 25 x 3.2mm / 1.6mm (Item No. 3771-200-32)
- 25 x 4.8mm / 2.4mm (Item No. 3771-200-48)
- 10 x 6.4mm / 3.2mm (Item No. 3771-200-64)
- 10 x 9.5mm / 4.7mm (Item No. 3771-200-95)
- 10 x 12.7mm / 6.4mm (Item No. 3771-200-127)
- 10 x 19.0mm / 9.5mm (Item No. 3771-200-190)
- 10 x 25.4mm / 12.7mm (Item No. 3771-200-254)



01

**Heat shrink tubing reels**

with inner adhesive, waterproof

## ► Technical specifications

- Shrink rate: 3: 1
- Shrinkage temperature: approx. 90 ° C
- Temperature range: -55 ° C to 110 ° C
- Approvals: UL 224 VW1, MIL -I-23053/4 Class
- Material: polyolefin
- Pre-Shrink Diameter: 3.0mm
- Diameter after shrinking: 1.2 mm
- Length: 5 m



Item No.	Ø before shrinking	Ø after shrinking	Spool length
3771-103-1	3,0 mm	1,2 mm	5,0 m
3771-106-2	6,0 mm	2,0 mm	3,5 m
3771-109-3	9,0 mm	3,0 mm	3,0 m
3771-112-4	12,0 mm	4,0 mm	5,0 m
3771-119-6	19,0 mm	6,0 mm	2,0 m
3771-124-8	24,0 mm	8,0 mm	1,5 m

02

**Heat shrink tubing reels**

hardly inflammable

## ► Technical specifications

- Shrink rate: 2: 1
- Shrink temperature: 90 ° C
- Long-term temperature resistance: -55 ° C to 125 ° C
- Material: polyolefin



Item No.	Ø before shrinking	Ø after shrinking	Spool length
3771-001-2	1,2 mm	0,6 mm	20 m
3771-002-4	2,4 mm	1,2 mm	15 m
3771-003-2	3,2 mm	1,6 mm	15 m
3771-004-8	4,8 mm	2,4 mm	12 m
3771-006-4	6,4 mm	3,2 mm	12 m
3771-009-5	9,5 mm	4,7 mm	8 m
3771-012-7	12,7 mm	6,4 mm	8 m
3771-019-0	19,1 mm	9,5 mm	5 m
3771-025-4	25,4 mm	12,7 mm	5 m



03

**Lighter gun**

Weight: 60 g

## ► Item no. 3555-999-1

## ► Technical specifications

- Dimensions: length 65 mm, height 110 mm, width 25 mm
- max.temperature: 1,300 ° C
- Working time (with filled lighter): 20 min.
- can only be used with the enclosed lighter
- The lighter inside is not filled
- We recommend filling with Normfest butane gas.



04

**butane gas**

- Item no. 8714-607-100
- Content: 100 ml
- Quantity per box: 12

- Technical specifications
- suitable for all common hot glue and soldering guns



01

**Car insulating corrugated pipe**

Plastic, with slot, collar 2 m

► **Technical specifications**

- temperature resistant: -40 ° C to 130 ° C
- slit on the side
- Material: PP - polypropylene
- Color: Black
- protects vehicle cables from external influences

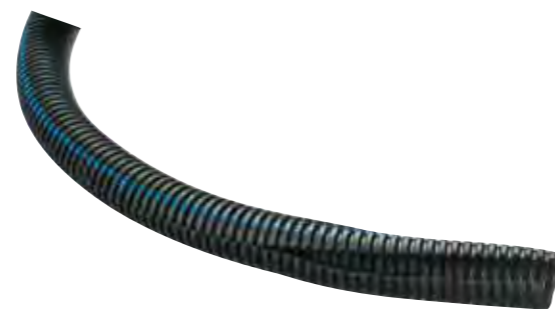

Item No.	Inside Ø:	Length:
3505-1-5	5 mm	2 m
3505-1-6	6 mm	2 m
3505-1-9	9 mm	2 m
3505-1-11	11 mm	2 m
3505-1-13	13 mm	2 m
3505-1-16	16 mm	2 m
3505-1-19	19 mm	2 m
3505-1-23	23 mm	2 m

02

**Truck insulating corrugated pipe**

Plastic, without slot, 50 m collar

► **Technical specifications**

- temperature resistant: -40 ° C to 130 ° C
- without a slot
- Material: PA6 - polyamide 6
- Inner Ø: 10 mm
- Color: Black
- protects vehicle cables from external influences



Item No.	Inside Ø:	Length:
3505-4-10	10 mm	50 m
3505-4-13	13 mm	50 m
3505-4-17	17 mm	50 m
3505-4-22	20 mm	50 m

03

**Insulating hoses**

PVC

25 meter bundle

► **Technical specifications**

- hardly inflammable
- self-extinguishing
- aging resistant
- silicone free
- fabric-free
- temperature resistant: -40 ° C to approx. 90 ° C



Item No.	Inside Ø:	Length:
3771-3	3 mm	25 m
3771-4	4 mm	25 m
3771-5	5 mm	25 m
3771-6	6 mm	25 m
3771-8	8 mm	25 m
3771-10	10 mm	25 m
3771-12	12 mm	25 m





01

**FLRY vehicle lines**Ø 0.5 mm<sup>2</sup>, 100 m, 1-wire

Item No.	colour
3770-050-0	black
3770-050-1	red
3770-050-2	blue
3770-050-4	yellow



02

**FLRY vehicle lines**Ø 0.75 mm<sup>2</sup>, 100 m, 1-wire

Item No.	colour
3770-007-5	black
3770-007-51	red
3770-007-52	blue
3770-007-54	yellow
3770-007-59	brown



03

**FLRY vehicle lines**Ø 1.0 mm<sup>2</sup>, 100 m, 1-wire

Item No.	colour
3770-010	black
3770-009-01	red
3770-009-02	blue
3770-009-03	white
3770-009-05	yellow
3770-009-09	brown



04

**FLRY vehicle lines**Ø 1.5 mm<sup>2</sup>, 100 m, 1-wire

Item No.	colour
3770-010-0	black
3770-010-1	red
3770-010-2	blue
3770-010-3	yellow
3770-010-4	green
3770-010-40	brown
3770-010-42	white



05

**FLRY vehicle lines**Ø 1.5 mm<sup>2</sup>, 50 m, 2-wire

Item No.	colour
3770-020-11	grey-red
3770-020-12	black-red
3770-020-14	green-red
3770-020-16	black-white
3770-020-17	black-green



06

**FLRY vehicle lines**Ø 2.5 mm<sup>2</sup>, 50 m, 1-wire

Item No.	colour
3770-010-5	black
3770-010-6	red
3770-010-7	blue
3770-010-60	yellow
3770-010-99	brown



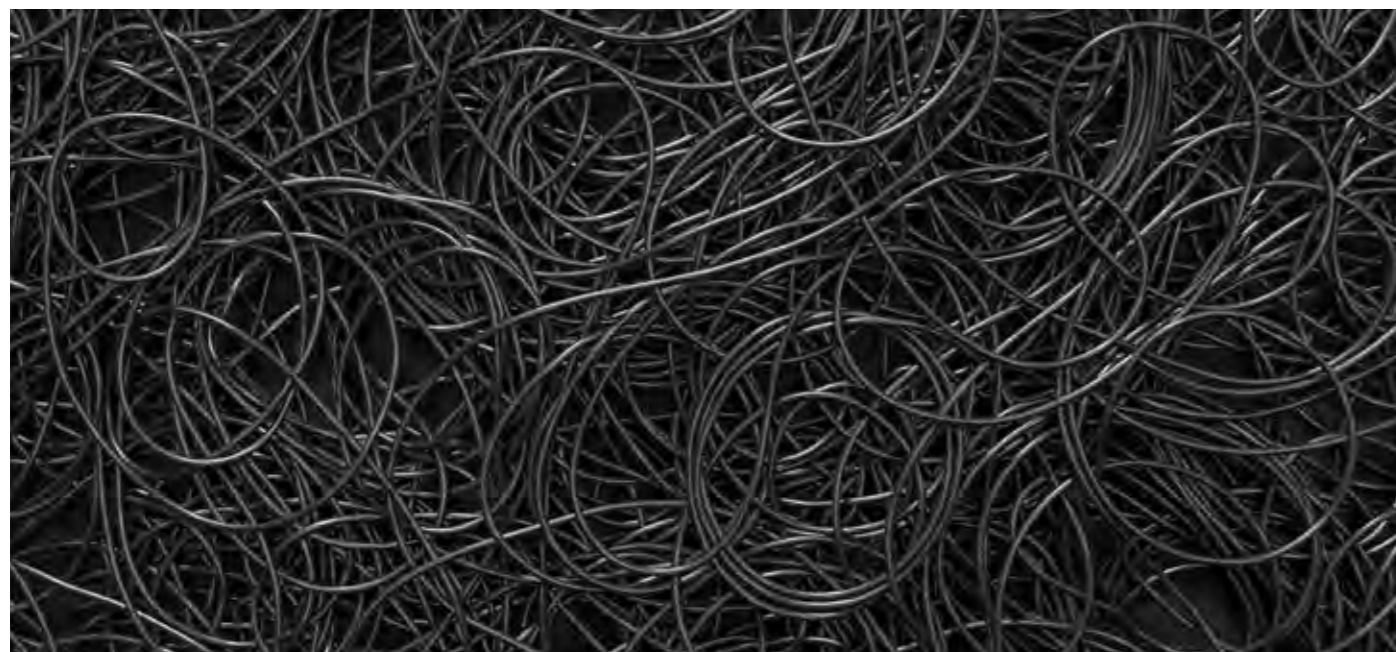

01

**FLRY vehicle lines**Ø 4.0 mm<sup>2</sup>, 50 m, 1-wire

Item No.	colour
3770-040-1	black
3770-040-2	red



02

**FLRY vehicle lines**Ø 6.0 mm<sup>2</sup>, 50 m, 1-wire

Item No.	colour
3770-060-1	black
3770-060-2	red



03

**Vehicle cables, round**

1-wire, red, with double insulation (double jacket)

Item No.	cross-section	Length [m]
3770-020-1	1,5 mm <sup>2</sup>	50
3770-020-4	2,5 mm <sup>2</sup>	25



04

**Vehicle cables, flat**

2-wire, double insulated, black-red

Item No.	execution	cross-section	length
3770-020-0	flat	2 x 0,75 mm <sup>2</sup>	50 m
3770-020-2	flat	2 x 1,5 mm <sup>2</sup>	25 m
3770-020-22	Flat	2 x 1,5 mm <sup>2</sup>	100 m
3770-020-3	flat	2 x 2,5 mm <sup>2</sup>	15 m
3770-020-5	round	2 x 2,5 mm <sup>2</sup>	15 m



05

**Automotive wire**

Vehicle cables with double insulation (double jacket)

Item No.	cross-section	Length [m]
3770-121	2 x 0,75 mm <sup>2</sup>	50
3770-4-075	4 x 0,75 mm <sup>2</sup>	50
3770-120	2 x 1,5 mm <sup>2</sup>	50
3770-116	3 x 1,5 mm <sup>2</sup>	50
3770-119-50	4 x 1,5 mm <sup>2</sup>	50
3770-118-50	7 x 1,5 mm <sup>2</sup>	50







01

**Speaker cable**  
50 m, brown-red



Item No.	cross-section	Length [m]
3770-030-0	2 x 0,75 mm <sup>2</sup>	50
3770-011-5	2 x 1,5 mm <sup>2</sup>	50

02

**Ribbon cable**  
25 m, red-black-white-blue



Item No.	cross-section	Length [m]
3770-400	4 x 0,75 mm <sup>2</sup>	25

03

**Double cable grommets**  
double-sided, silicone-proof

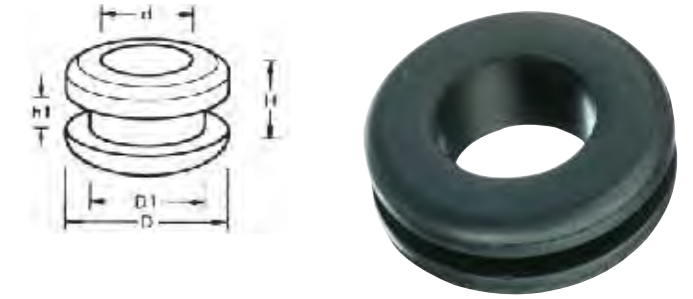

Item No.	d mm	d1 ø mm	D.	H	H1 mm	PU
3561-663-4	4	6	9	6	1,0	50
3561-663-2	6	9	11	6	1,0	50
3561-664-6	6	10	13	8	2,0	50
3561-664-8	9	11	16	6	1,0	25
3561-665-0	10	12	18	11	1,0	25
3561-665-2	12	20	24	10	4,0	25
3561-666-2	13	21	26	9	2,0	25
3561-666-3	16	24	3,0	11	3,0	25
3561-666-6	25	30	36	11	3,5	25
3561-666-5	21	31	38	11	1,5	25

04

**Sealing plug**  
Thermoplastic rubber



Item No.	Outside Ø	Inside-Ø	PU
3561-700-8	9,5 mm	6,4 mm	50
3561-700-7	12,8 mm	11,2 mm	50
3561-700-6	15,5 mm	12,7 mm	25
3561-700-5	18,4 mm	14,9 mm	25
3561-700-4	19,0 mm	15,5 mm	25
3561-700-3	22,1 mm	19,0 mm	25
3561-700-2	26,6 mm	22,0 mm	25
3561-700-1	27,5 mm	24,5 mm	25

01

**Blade fuses**

Low profile



Item No.	Model	colour	PU
3731-302	2 A	grey	25
3731-303	3 A	Violet	25
3731-304	4 A	pink	25
3731-305	5 A	brownish	25
3731-307-5	7,5 A	brown	25
3731-310	10 A	red	25
3731-315	15 A	blue	25
3731-320	20 A	yellow	25
3731-325	25 A	transparent	25
3731-330	30 A	green	25

02

**Blade fuses**

Mini



Item No.	Model	colour	PU
3731-102	2 A	grey	25
3731-103	3 A	Violet	25
3731-104	4 A	pink	25
3731-105	5 A	brownish	25
3731-107-5	7,5 A	brown	25
3731-110	10 A	red	25
3731-115	15 A	blue	25
3731-120	20 A	yellow	25
3731-125	25 A	transparent	25
3731-130	30 A	green	25

03

**Blade fuses**

normal



Item No.	Model	colour	PU
3731-035	35 A	dark green	50
3731-002	2 A	grey	50
3731-003	3 A	Violet	50
3731-005	5 A	brownish	50
3731-007-5	7,5 A	brown	50
3731-010	10 A	red	50
3731-015	15 A	blue	50
3731-020	20 A	yellow	50
3731-025	25 A	transparent	50
3731-030	30 A	green	50
3731-040	40 A	orange	50

04

**Blade fuses**

Maxi



Item No.	Model	colour	PU
3731-220	20 A	yellow	10
3731-230	30 A	green	10
3731-240	40 A	orange	10
3731-250	50 A	red	10
3731-260	60 A	blue	10
3731-270	70 A	brownish	10
3731-280	80 A	transparent	10
3731-210-0	100 A	Violet	10

05

**Blade fuses**

mikrOTO II



Item No.	Model	colour	PU
3731-11-5	5 A	light brown	25
3731-11-10	10 A	red	25
3731-11-15	15 A	blau	25
3731-11-20	OTO-JLP	yellow	25
3731-11-25	25 A	transparent	25
3731-11-30	30 A	green	25
3731-11-75		brown	25

06

**Blade fuses**

mikrOTO III



Item No.	Model	colour	PU
3731-12-5	5 A	light brown	25
3731-12-10	10 A	red	25
3731-12-15	15 A	blau	25
3731-12-75	7,5 A	brown	25

07

**Screw lock**

Midi, hole spacing 30 mm



Item No.	Model	colour	PU
3731-8-30	30 A	orange	10
3731-8-40	40 A	green	10
3731-8-50	50 A	red	10
3731-8-60	60 A	yellow	10
3731-8-70	70 A	brown	10
3731-8-80	80 A	white	10
3731-8-100	100 A	blue	10
3731-8-125	125 A	pink	10
3731-8-150	150 A	grey	10

08

**Screw lock**

Mega, hole spacing 51 mm



Item No.	Model	colour	PU
3731-9-100	100 A	yellow	10
3731-9-125	125 A	green	10
3731-9-150	150 A	red	10
3731-9-175	175 A	white	10
3731-9-200	200 A	blue	10
3731-9-225	225 A	brown	10
3731-9-250	250 A	Rose	10
3731-9-300	300 A	grey	10
3731-9-400	400 A	purple	10
3731-9-500	500 A	brown	10



01  
**Blade fuses**  
OTO-J



Item No.	Model	colour	PU
3731-5-20	20 A	turquoise	10
3731-5-25	25 A	white	10
3731-5-30	30 A	pink	10
3731-5-40	40 A	green	10
3731-5-50	50 A	red	10
3731-5-60	60 A	yellow	10

02  
**Blade fuses**  
OTO-AS



Item No.	execution	colour	PU
3731-4-20	20 A	turquoise	10
3731-4-30	30 A	pink	10
3731-4-40	40 A	green	10
3731-4-50	50 A	red	10

03  
**Blade fuses**  
OTO-B / BT



Item No.	Model	colour	PU
3731-7-30	30 A	pink	10
3731-7-40	40 A	green	10
3731-7-50	50 A	red	10
3731-7-60	60 A	yellow	10
3731-7-70	70 A	brown	10
3731-7-80	80 A	black	10
3731-7-100	100 A	blue	10
3731-7-120	120 A	white	10
3731-7-140	140 A	dark red	10

04  
**Blade fuses**  
OTO-JLP



Item No.	Model	colour	PU
3731-6-20	20 A	turquoise	10
3731-6-25	25 A	white	10
3731-6-30	30 A	pink	10
3731-6-40	40 A	green	10
3731-6-50	50 A	red	10
3731-6-60	60 A	yellow	10

05  
**Fuse cuboOTO**  
Lifting platforms



Item No.	Model	colour	PU
3731-010-50	50 A	cream	10
3731-010-75	75 A	cream	10
3731-010-100	100 A	cream	10
3731-010-150	150 A	cream	10
3731-010-200	200 A	cream	10
3731-010-1	Fixing nut M8	black	10

06  
**MSO backups**  
are installed in almost all vehicles of the VW Group (Volkswagen, Skoda, Audi and Seat)



Item No.	execution	PU
3731-10-30	30 A	50
3731-10-40	40 A	50
3731-10-50	50 A	50
3731-10-60	60 A	50
3731-10-80	80 A	50
3731-10-100	100 A	50

07  
**Melt strip fuses**



Item No.	execution	PU
3730-25-5	5 A	50
3730-25-8	50	50
3730-25-161	50	50
3730-25-25	25 A	50
3730-25-40	40 A	50

08  
**Sheet metal strip fuses**

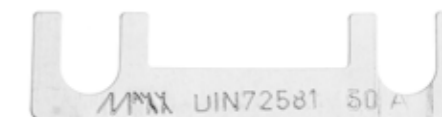

Item No.	execution	PU
3731-50	50 A	50
3731-80	80 A	50

09  
**Glass fuses**



Item No.	execution	PU
3733-20-1	1 A	10
3733-20-2	2 A	10
3733-20-315	3,15 A	10
3733-20-4	4 A	10
3733-20-5	5 A	10

01

**Automatic fuse SAE J553**

Item No.	execution	colour	PU
3731-13-5	5 A	beige	2
3731-13-75	7.5 A	brown	2
3731-13-10	10 A	red	2
3731-13-15	15 A	blue	2
3731-13-20	20 A	yellow	2
3731-13-25	25 A	white	2
3731-13-30	30 A	green	2



02

**Automatic fuse SAE J553 set**

7 pieces

► Item no. 3731-13-999

► Content:

- one fuse each
- 5A / 7.5A / 10A / 15A / 20A / 25A / 30A



03

**Assortment of plug fuses**

including tester and gripper set

► Item no. 1957-730-1

► Contents: 161 parts

- 10 x 3A (Item no. 3731-003)
- 10 x 5A (Item No. 3731-005)
- 10 x 7.5A (Item No. 3731-007-5)
- 10 x 10A (Item No. 3731-010)
- 10 x 15A (Item No. 3731-015)
- 10 x 20A (Item No. 3731-020)
- 10 x 25A (Item No. 3731-025)
- 10 x 30A (Item No. 3731-030)
- 10 x 3A MINI (Item No. 3731-103)
- 10 x 5A MINI (Item No. 3731-105)
- 10 x 7.5A MINI (Item No. 3731-107-5)
- 10 x 10A MINI (Item No. 3731-110)
- 10 x 15A MINI (Item No. 3731-115)
- 10 x 20A MINI (Item No. 3731-120)
- 10 x 25A MINI (Item No. 3731-125)
- 10 x 30A MINI (Item No. 3731-130)
- 1 x tester and gripper set (item no. 3731-150)



04

**Assortment of plug fuses**

Mini and low profile fuses

► Item no. 1957-730-2

► Contents: 400 fuses

- 25 x 3A MINI plug-in fuse (item no. 3731-103)
- 25 x 5A MINI plug-in fuse (item no. 3731-105)
- 25 x plug-in fuse 7.5A MINI (item no. 3731-107-5)
- 25 x plug-in fuse 10A MINI (item no. 3731-110)
- 25 x 15A MINI fuse (item no. 3731-115)
- 25 x plug-in fuse 20A MINI (item no. 3731-120)
- 25 x plug-in fuse 25A MINI (item no. 3731-125)
- 25 x 30A MINI fuse (item no. 3731-130)
- 25 x 3A / LOW-PROFILE plug-in fuse (item no. 3731-303)
- 25 x 5A / LOW-PROFILE plug-in fuse (item no. 3731-305)
- 25 x plug-in fuse 7.5A / LOW-PROFILE (item no. 3731-307-5)
- 25 x plug-in fuse 10A / LOW-PROFILE (item no. 3731-310)
- 25 x plug-in fuse 15A / LOW-PROFILE (item no. 3731-315)
- 25 x plug-in fuse 20A / LOW-PROFILE (item no. 3731-320)
- 25 x plug-in fuse 25A / LOW-PROFILE (item no. 3731-325)
- 25 x 30A / LOW-PROFILE plug-in fuse (item no. 3731-330)



01

**Fuse distributor**

Including supply line and plug

## ► Technical specifications

- for the installation of additional devices in the vehicle, e.g. LED daytime running lights
- 2 fuse slots
- easy and safe installation
- Cable length: 10 cm

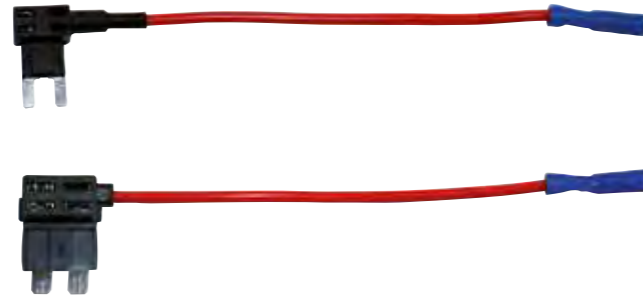

Item No.	execution	PU
3731-000-400	mini	5
3731-000-500	normal	5

02

**Fuse holder**

for MIDI backup

- Item no. 3731-8-000



03

**Fuse holder**

for MEGA fuse

- Item no. 3731-9-000



04

**Flat fuse holder Maxi**for "maxi" plug-in fuses, for cable lugs and M5 screws, for cable cross-sections from 2.5 mm<sup>2</sup> to 10 mm<sup>2</sup>

- Item no. 3731-200 | Flat fuse holder Maxi

- Item no. 3731-200-9 | cover

## ► Technical specifications

- for cable lugs and M5 screws
- for cable cross-sections from 2.5 mm<sup>2</sup> - 10 mm<sup>2</sup>



05

**Flat fuse holder for plug-in fuse**

„normal“

- Item no. 3731-000

## ► Technical specifications

- with connection for flat receptacles with a width of 6.3 mm



06

**Fuse holder**

for fusible links

- Item no. 3555-625

## ► Technical specifications

- including 8A fuse
- with bayonet lock



07

**Fuse holder**as a quick connector for "normal" plug-in fuses for cable cross-sections from 0.75 mm<sup>2</sup> to 2.0 mm<sup>2</sup>

- Item no. 3555-972

## ► Technical specifications

- Quick connector
- for cable cross-sections 0.75 mm<sup>2</sup> - 2.0 mm<sup>2</sup>

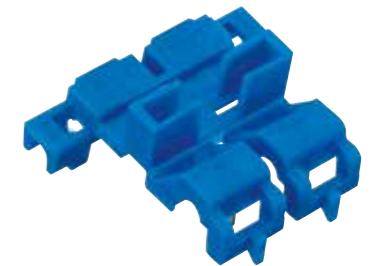

08

**Tester and gripper set**

for plug fuses

- Item no. 3731-150



01

**Flat fuse holder for plug-in fuse**„Normal“ cable length each 25 cm and 1.5 mm<sup>2</sup> cable cross-section up to 20 A

▶ Item no. 3731-000-200

▶ Technical specifications

- Cable length 25 cm each
- Cable cross-section 1.5 mm<sup>2</sup> each
- for fuses up to 20 A.



02

**Flat fuse holder for plug-in fuse**„Normal“ cable length each 25 cm and 2.5 mm<sup>2</sup> cable cross-section up to 30 A

▶ Item no. 3731-000-300

▶ Technical specifications

- Cable length 25 cm each
- Cable cross-sections each 2.5 mm<sup>2</sup>
- for fuses up to 30 A.



03

**Blade fuse holder**for plug-in fuses „mini“ cable length each? 13 cm and 3.3 mm<sup>2</sup> cable cross-section

▶ Item no. 3731-100

▶ Technical specifications

- Cable length each 13 cm
- Cable cross-section 3.3 mm<sup>2</sup>

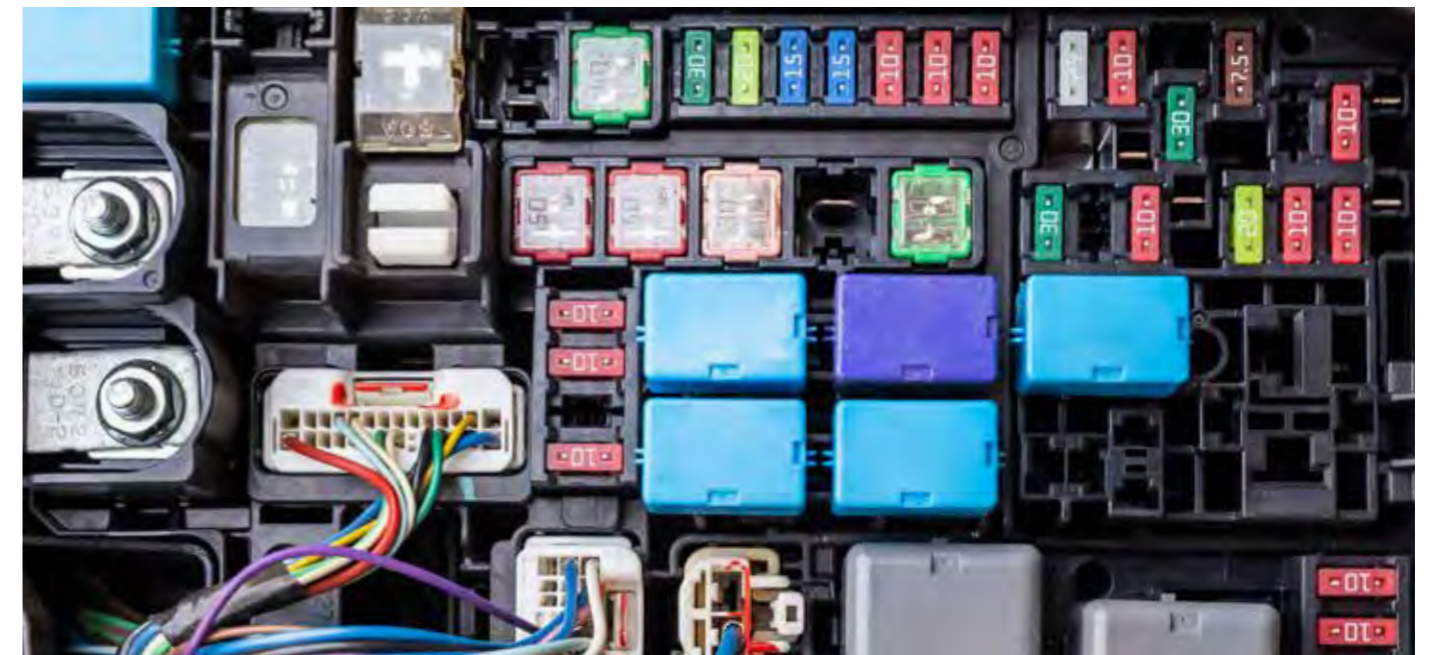

04

**Flat fuse holder for low profile fuses**with a 1.3mm<sup>2</sup> cable

▶ Item no. 3731-000-405

▶ Technical specifications

- easy to connect
- Protection without cutting
- Cable: 1.3mm<sup>2</sup>
- Length: 120mm with blue connector



05

**Flat fuse holder for Mikroto II fuses**with a 1.3mm<sup>2</sup> cable

▶ Item no. 3731-000-407

▶ Technical specifications

- easy to connect
- Protection without cutting
- Cable: 1.3mm<sup>2</sup>
- Length: 120mm with blue connector





01

**Flat fuse holder for mini fuses**  
with two 2.5mm<sup>2</sup> cables on each side

► Item no. 3731-000-406

► Technical specifications

- Cable: 2.5mm<sup>2</sup>
- Length: 135mm on each side
- transparent cover
- with integrated sealing ring
- robust housing
- Splash-proof when closed (IP55)



02

**Blade fuse holder for mini plug-in fuses**  
with 1.5mm<sup>2</sup> cables

► Item no. 3731-000-401

► Technical specifications

- Cable diameter: 1.5 mm<sup>2</sup>
- Length: 130mm each side
- Phosphor bronze (CuSn) fuse sockets
- robust black holder housing (PA6 GF30)
- clear cover (PC) with integrated O-ring
- splash-proof, when used with cover (IP56)



03

**Flat fuse holder for Mikroto II fuses**  
with 3.3mm<sup>2</sup> cables

► Item no. 3731-000-408

► Technical specifications

- Cable: 3.3 mm<sup>2</sup>
- Length: 135 mm on both sides
- robust housing
- CuZn fuse sockets galvanized
- splash-proof with cover (IP54)
- self-extinguishing body and masking materials
- is used for mikrOTO II fuses
- corresponds to ISO 8820-12



04

**Blade fuse holder for mini plug-in fuses**  
with 2.5mm<sup>2</sup> cables

► Item no. 3731-000-402

► Technical specifications

- Cable diameter: 2.5 mm<sup>2</sup>
- Length: 130mm each side
- Phosphor bronze (CuSn) fuse sockets
- robust black holder housing (PA6 GF30)
- clear cover (PC) with integrated O-ring
- splash-proof, when used with cover (IP56)



05

**Blade fuse holder for mini plug-in fuses**  
with 2.5mm<sup>2</sup> cables

► Item no. 3731-000-403

► Technical specifications

- Cable diameter: 2.5 mm<sup>2</sup>
- Length: each 130mm
- robust housing
- Splash-proof when closed

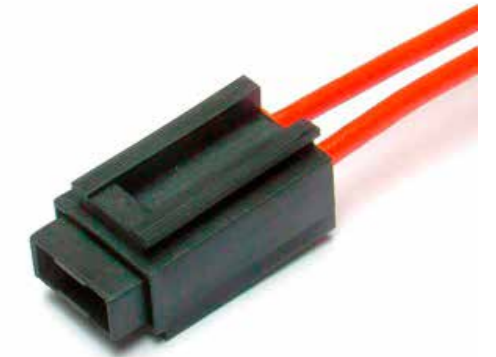

06

**cover**  
for flat fuse holder 3731-000-403

► Item no. 3731-000-404



01

**LED penlight**

Including USB charging cable

► Item no. 7982-70-160

## ► Product description

- 2W LED main light source with two light levels (200 lm / 100 lm)
- 1W additional lamp (100 lm)
- Wide-angle illumination
- Length: 164 mm
- Burn time: 1.5 hours - 2.5 hours depending on the intensity
- Lighting range: 13 m to 22 m
- Magnet on the bottom
- lateral retaining clip
- Charge indicator
- with deep discharge protection
- Housing made of aluminum and plastic
- Weight: 55 g (lamp with battery) 18.3 g (battery)
- Charging time: approx. 2 hours
- USB-C charging cable for quick charging
- Scope of delivery: lamp, USB type C charging cable, multilingual operating instructions



02

**Workshop lamp PL120**

Including USB charging cable

► Item no. 7982-70-20

## ► Product description

- robust and splash-proof plastic housing with rubberized grip surface
- small additional light on the lamp head
- Light intensity: 120 lumens
- Burn time: main light 3.5 hours
- Burn time: additional light 5 hours
- Attachment: retaining clip and magnet
- Battery: permanently installed Li-Ion battery pack (3.7V / 750mAh)
- Charging option: via micro USB socket, optionally via AC / DC power supply (110V-240V) or car adapter (12-24V)
- Scope of delivery: USB charging cable 150 cm, operating instructions
- Total length: 17 cm
- Length of LED lamps: 3 cm
- splash-proof



03

**LED professional penlight PL20**

incl. 2 x AAA micro batteries

► Item no. 7982-70-80

## ► Product description

- modern LED technology
- Incl. 2x AAA batteries, wrist strap and belt clip
- Weight: 64 g (including batteries)
- Dimensions: 142 x 16 mm







01

**Short adapter 13-pin to 7-pin**

13-pin to 7-pin

▶ Item no. 3555-310-12

## ▶ Technical specifications

- Towing vehicle with 13-pin coupling
- Trailer with 7-pin plug
- Length: 106 mm
- Material: PA6 GF30
- 12 V



02

**Mini-short adaptor**

7-pin to 13-pin

▶ Item no. 3555-310-112

## ▶ Technical specifications

- Towing vehicle with 7-pin coupling
- Trailer with 13-pin connector
- Length: 50mm
- Material: PA6 GF30
- 12 V



03

**Short adapter 13 to 7/13 WeSt system**

13-pin DIN / ISO11446 socket on 7-pin

▶ Item no. 3555-310-13

## ▶ Technical specifications

- Multicon, two different connections can be adapted
- WeSt system
- 13- to 7-pin
- 12 V
- Length: 106 mm
- Material: PA6 GF30



04

**Mini short adapter 13-pin to 7-pin**

13-pin to 7-pin

▶ Item no. 3555-310-119

## ▶ Technical specifications

- Towing vehicle with 13-pin coupling
- Trailer with 7-pin plug
- Material: PA6 GF30
- Total length: 52 mm
- 12 V





01

**plug**

7-pin

- ▶ Item no. 3555-305-117 | Light metal
- ▶ Item no. 3555-305-118 | Gasket
- ▶ Item no. 3555-405-117 | Plastic
- ▶ Item no. 3555-310-120 | Spare gasket
- ▶ Technical specifications
  - Length: 44mm
  - Load capacity: 20 A at 12 V.
  - Screw connection



02

**socket**

13-pin, including seal

- ▶ Item no. 3555-310-117 | Plastic
- ▶ Item no. 3555-310-120 | Spare gasket
- ▶ Technical specifications
  - Length: 50mm
  - Load capacity: 20 A at 12 V.
  - OEM version
  - Material: PA6 GF30



03

**13-pin connector**

13-pin

- ▶ Item no. 3555-310-517
- ▶ Technical specifications
  - plastic
  - Load capacity: 20 A
  - with bayonet lock
  - 12 V
  - 13-pin



04

**plug**

7-pin

- ▶ Item no. 3555-305-517 | Light metal
- ▶ Item no. 3555-405-517 | Plastic
- ▶ Technical specifications
  - Length: 91.8 mm
  - Load capacity: 20 A at 12 V.
  - with screw contact
  - to plug





01

**EBS socket 7-pin**

7-pin

▶ Item no. 3555-310-7

▶ Technical specifications

- with screw contacts
- GGVS / ADR tested
- 7-pin
- 24 V



04

**3-pin socket**

3 pole

▶ Item no. 3555-310-60

▶ Technical specifications

- with screw contacts
- Type S
- Load capacity: 20 A to 24 V.
- plastic
- ISO 1185 K pin
- 3 pole
- 24 V



02

**7-pin socket**

7-pin

▶ Item no. 3555-305-286

▶ Technical specifications

- with screw contacts
- Rubber seal in the cover
- Type S
- Load capacity: 20 A to 24 V.
- ISO 3731 K socket
- 7-pin
- 24 V



05

**15-pin sockets**

15-pin

▶ Item no. 3555-310-15

▶ Technical specifications

- with screw contacts
- GGVS / ADR tested
- 15-pin
- 24 V



03

**7-pin socket**

7-pin

▶ Item no. 3555-305-287

▶ Technical specifications

- with screw contacts
- Rubber seal in the cover
- Type N
- Load capacity: 20 A to 24 V.
- ISO 1185 K pin
- 7-pin
- 24 V



06

**Short adapter 15-pin to 7-pin**

15-pin to 7-pin

▶ Item no. 3555-320-52

▶ Technical specifications

- Adapter from 15-pin to 7-pin
- ISO 12098
- plastic
- 24 V





01

**EBS plug 7-pin**  
7-pin

▶ Item no. 3555-310-70

- ▶ Technical specifications
- with screw contacts
  - GGVS / ADR tested
  - 7-pin
  - 24 V



02

**15-pin connector**  
15-pin

▶ Item no. 3555-310-150

- ▶ Technical specifications
- with screw contacts
  - GGVS / ADR tested
  - 15-pin
  - 24 V



03

**3-pin connector**  
3 pole

▶ Item no. 3555-310-6

- ▶ Technical specifications
- with screw contacts
  - Type S
  - Load capacity: 20 A to 24 V.
  - plastic
  - 3 pole
  - 24 V



04

**plug**  
7-pin

▶ Item no. 3555-305-587 | Metal

▶ Item no. 3555-305-589 | Plastic

- ▶ Technical specifications
- Load capacity: 20 A to 24 V.
  - Length: 116 mm
  - Type N / „light“
  - with screw contacts



05

**plug**  
7-pin

▶ Item no. 3555-305-586 | Metal

▶ Item no. 3555-305-588 | Plastic

- ▶ Technical specifications
- Load capacity: 20 A to 24 V.
  - Length: 116 mm
  - Type S / „secondary consumers“
  - with screw contacts





01

**7-pole helix**

7-pin

▶ Item no. 3555-320-43

## ▶ Technical specifications

- Working length: 3.0 m
- Material: PUR
- Restoring force corresponds to the OEM regulations
- with waterproof connectors
- Type S - 3731
- 6 sockets, 1 pin
- 7-pin
- 24 V



02

**7-pole helix**

7-pin

▶ Item no. 3555-320-42

## ▶ Technical specifications

- Working length: 3.0 m
- Material: PUR
- Restoring force corresponds to the OEM regulations
- with waterproof connectors
- Type N
- little twisted
- 7-pin
- ISO 1185
- 24 V



03

**EBS spiral cable 7-pole**

7-pin

▶ Item no. 3555-320-45

## ▶ Technical specifications

- Working length: 3.5 m
- Material: PUR
- Restoring force corresponds to the OEM regulations
- little twisted
- 7-pin
- 24V



04

**15-pole helix**

15-pin

▶ Item no. 3555-320-50

## ▶ Technical specifications

- Working length: 3.5 m
- with clamp connection
- Material: PUR
- Restoring force corresponds to the OEM regulations
- little twisted
- 15-pin
- 24 V



05

**Adapter spiral cable 15-pin to 2 x 7-pin**

15-pin to 2 x 7-pin

▶ Item no. 3555-320-53

## ▶ Technical specifications

- for the power supply of new? commercial vehicle tractors on older trailers
- 13 poles occupied in accordance with standards
- encapsulated plugs type „N“ and type „S“
- Working length: 3.5 m
- Material: PUR
- Restoring force corresponds to the OEM regulations
- little twisted
- 24 V



06

**Adapter spiral cable 15-pin to 2 x 7-pin**

15-pin to 2 x 7-pin

▶ Item no. 3555-320-51

## ▶ Technical specifications

- 13-pin assigned
- Working length: 3.5 m
- Type N / S
- Material: PUR
- Restoring force corresponds to the OEM regulations
- little twisted
- 15- to 7-pin
- 24 V



01

**Distribution box**

8-fold

► Item no. 1004-100-1

► Technical specifications

- 8-pin cable junction box
- with 32 flat plugs
- 4 rows
- waterproof housing
- Lid material: aluminum
- Housing material: polyester BMC
- Closure: 2 clamps
- Dimensions (L x W x H): 150 mm x 93 mm x 45 mm
- Fixing: 2 holes Ø 5.5 mm
- Center distance (mm) 90.0



02

**Distribution box**

16 times

► Item no. 1004-100

► Technical specifications

- ADR compatible
- TÜV component marking (TÜ.EGG.028-96)
- water-protected, steam jet resistant plastic housing IP69K
- Housing material: PA
- with plug insert (11 potentials 8-pin and 4 potentials 4-pin)
- Closure: 2 clamps or 4 screws (recommended tightening torque: 1.7 Nm)
- Dimensions (L x W x H): 167 mm x 157 mm x 99 mm
- Fixing: 4 holes Ø 5.5 mm
- Center distance 65/110 mm
- 16 PG screw connections



03

**Battery clamps for cars**max. cable connection: 50 mm<sup>2</sup>

Item No.	execution	PU
3510-1	+ on the left	1
3510-2	- on the left	1
3510-3	- on the right	1
3510-4	+ on the right	1



04

**Battery clamps for commercial vehicles**

Tinned brass

Item No.	execution	PU
3510-7	+ on the left	1
3510-6	- on the right	1



05

**Battery clamps Büssing**

Tinned brass

Item No.	execution	PU
3510-20	- on the left	1
3510-19	+ on the right	1





01

**Soldering cable lugs**

Material: tinned brass



Item No.	drilling	Cable cross-section	DIN designation	d2	PU
3557-921-9	M6	10 mm <sup>2</sup>	6 x 4,3	11	25
3557-922-0	M8	10 mm <sup>2</sup>	8 x 4,3	15	25
3557-922-4	M8	16 mm <sup>2</sup>	8 x 5,4	15	25
3557-922-8	M8	25 mm <sup>2</sup>	8 x 6,8	15	25
3557-922-81	M8	35 mm <sup>2</sup>	8 x 8,2	15	25
3557-923-6	M8	50 mm <sup>2</sup>	8 x 9,5	17	25
3557-922-1	M10	10 mm <sup>2</sup>	10 x 4,3	19	25
3557-922-9	M10	25 mm <sup>2</sup>	10 x 6,8	19	25
3557-923-3	M10	35 mm <sup>2</sup>	10 x 8,2	19	25
3557-923-7	M10	50 mm <sup>2</sup>	10 x 9,5	19	10
3557-924-0	M10	70 mm <sup>2</sup>	10 x 11,2	21	10
3557-923-0	M12	25 mm <sup>2</sup>	12 x 6,8	22	25
3557-923-8	M12	50 mm <sup>2</sup>	12 x 9,5	22	10
3557-924-1	M12	70 mm <sup>2</sup>	12 x 11,2	22	10

02

**soldering iron**

230 volts, 150 watts

## ► Item no. 4982-900

## ► Technical specifications

- 230 volts
- 150 watts
- Temperature range: 450 ° C
- Heating-up time: 3 min.



03

**Solder wire**

250 g rolls

## ► Technical specifications

- 250 g roll
- Flux-filled 3.5%
- Alloy: PB6OSN40
- Melting range: 183 ° C to 238 ° C
- Ratio: at 60, tin 40
- Flux according to DIN EN 29454.1, 1.1.1.B or DIN EN 61190-1-3

Item No.	Size
4982-50	Ø 1 mm
4982-60	Ø 2 mm

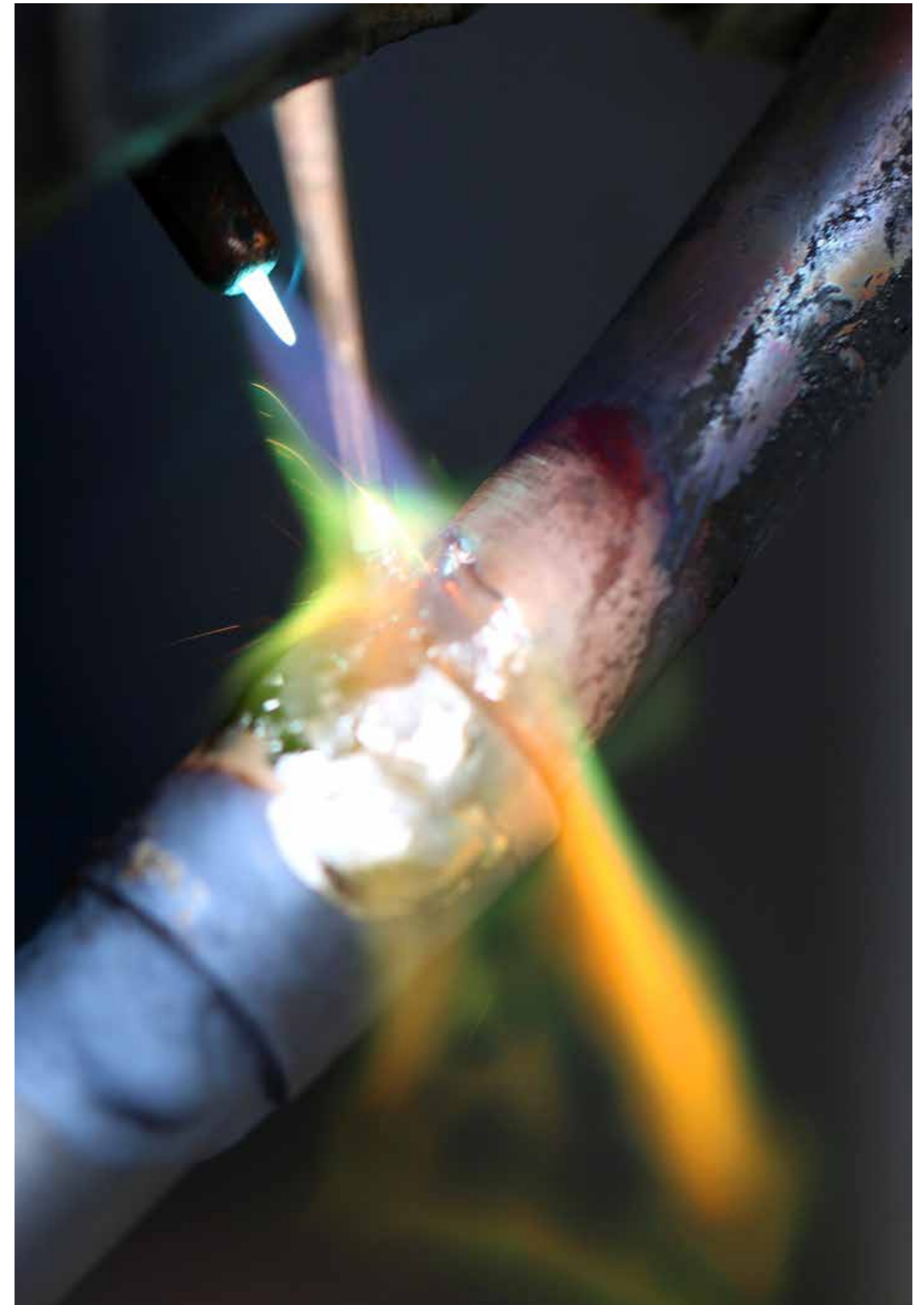





01

**Tyron 6 mm**

CoPrA® tire repair set up to 270 km / h

## ► Item no. 9879-970

## ► Technical specifications

- Tread damage: max. 6 mm (measured inside)
- with corrosion protection for belt and carcass
- 100% self-vulcanising repair body
- no weakening of the strength members (belt & carcass) by drilling / milling
- Tests at TÜV-Süd, tyre and wheel test centre Munich: Endurance and maximum speed: ECE R30 for passenger car tyres, compliant with §36 StVZO (BMV 13/36)
- Corrosion Protect Active ® pat. pend
- highly tear and shear resistant in tyre and steel belt due to state-of-the-art technology
- applicable for straight and up to 45° angled punctures, without enlargement of the damage
- for all passenger car and van tubeless tyres
- for tyres up to and including 270 km/h (speed index H)
- removes moisture from the repair area, converts existing rust into solid, inert material and protects against new rust (CoPrA®)
- pat. pend (dpa)
- Corrosion Protect Active ® pat. pend
- twice as fast as fungal repair, as no mechanical roughening inside, no drilling or milling
- no drying time necessary for the vulcanising solution
- 
- Contents of the set:
  - 50 x 6mm repair bodies (item no. 9879-972 - refill pack)
  - 1 x insertion awl (item no. 9879-976)
  - 1 x T-handle (Article-No. 9879-975)
  - 1 x pre-cutter (article no. 9879-978)
  - 1 x vulcanising compound CoPrA® pat. pend 25ml (article no. 9879-980)
  - 1 x liquid patch CoPrA® pat. pend 50ml (Article-No. 9879-979)
  - 1 x scraper
  - 1 x Allen key



GEPRÜFTE QUALITÄT  
 - ECE R30 (PKW)  
 - ECE R75 (Motorrad)  
 - ECE R54 (LKW)  
 + Dauerlauf mit Überlast  
 + zulässige  
 Hochgeschwindigkeitserhöhung  
 + konform §36  
 StVZO (BMV 13/36)

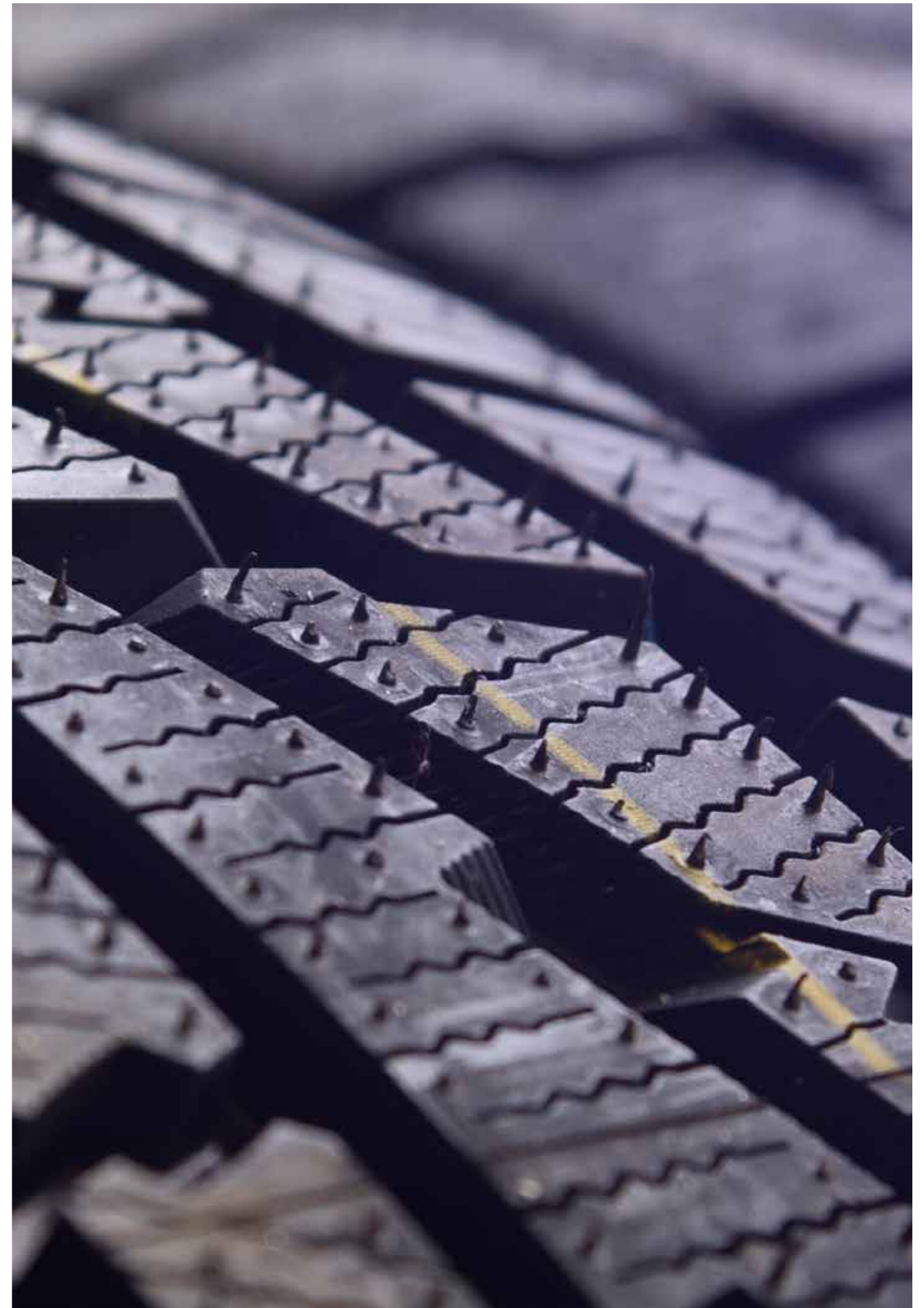





01

**Cutter**

For mushroom-shaped repair bodies for repairing defective tires

Item No.	Ø
9879-93-03	3,0 mm
9879-93-06	6.0 mm



02

**Scooter**

for tire probes

- ▶ Item no. 9879-91-2
- ▶ PU: 1



03

**Special rubber milling cutter**

for roughening the inner surface of the tire

- ▶ Item no. 9879-91-1
- ▶ PU: 1



04

**T-handle**

- ▶ Item no. 9879-975
- ▶ PU: 1



05

**Inset**

for Tyron repair kit

Item No.	Length [mm]	suitable for:
9879-976	115	Passenger cars
9879-977	195	truck



06

**Vorstecher für Tyron Reparatur-Set CoPrA®**

for cleaning the branch duct

- ▶ Item no. 9879-978
- ▶ PU: 1



07

**Liquid plaster CoPrA® for Tyron repair set**

- ▶ Item no. 9879-979
- ▶ Content: 50 ml
- ▶ PU: 1

- ▶ Technical specifications
- with corrosion protection
- Liquid plaster must be applied from the inside to the damaged area / loop



08

**Vulcanizing compound CoPrA® for Tyron repair set**

- ▶ Item no. 9879-980
- ▶ Content: 25 ml
- ▶ PU: 1

- ▶ Technical specifications
- with corrosion protection
- for insertion into the puncture channel of the damaged area



09

**Tire probes**

Refill pack for the Tyrex repair system

- ▶ Technical specifications
- Mushroom-shaped repair body suitable for radial and cross-ply tires
- permitted for speed class V.
- Processing only in connection with the vulcanizing compound (Article No. 9879-94-250)

Item No.	Ø mm	PU
9879-92-03	3	25
9879-92-04	4,5	24
9879-92-06	6	24
9879-92-10	10	10



01

**Tyre fitting paste**

Black tap / White tap

- ▶ Item no. 2894-455
- ▶ Content: 5 kg
- ▶ Colour: black
- ▶ PU: 1

- ▶ Item no. 2894-457
- ▶ Content: 5 kg
- ▶ Colour: white
- ▶ PU: 1

▶ **Technical specifications**

- manufactured according to TÜV guidelines
- suitable for run-flat tires
- frost-proof
- quick drying so that the tire cannot slip on the rim
- excellent ventilation behavior
- high lubricity
- biodegradable
- no risk of allergies for the fitters



02

**Tyre fitting paste**

Run-tap

- ▶ Item no. 2894-459
- ▶ Content: 5 kg
- ▶ PU: 1

▶ **Technical specifications**

- especially for run-flat, wide and low profile tires
- increased sliding effect with optimal sealing effect
- dries quickly and transparently
- also for warm / hot regions
- no drying out in an open bucket
- Consistency: creamy
- Colour blue
- Processing temperature: -10 ° C to 50 ° C



03

**Tyre fitting spray**

Run fluid

- ▶ Item no. 2894-460-400
- ▶ Content: 400 ml
- ▶ Quantity per box: 6

- ▶ Item no. 2894-460
- ▶ Content: 5 Liter
- ▶ PU: 1

▶ **Technical specifications**

- quick and easy installation of all types of tires (including motorcycle, low profile and wide tires)
- fast drying
- does not leave any visible residue on tire edges
- prevents assembly damage to the tire flanks
- easy to dose because it can be sprayed
- silicone free



04

**Tyre chalk**

strong and smudge-proof grease chalk

- ▶ Item no. 9879-91-3
- ▶ Colour: white
- ▶ PU: 12

- ▶ Item no. 9879-91-4
- ▶ Colour: yellow
- ▶ PU: 12

▶ **Technical specifications**

- 17.5 mm diameter
- approx 28g
- with tip for writing and precise identification
- 12 pieces per pack
- Holders are available separately (Article No. 9879-91-5)



05

**bracket**

for tyre chalk

- ▶ Item no. 9879-91-5
- ▶ PU: 1



06

**brush**

for tyre fitting paste

- ▶ Item no. 4693-080-0
- ▶ PU: 1





01

**Hand tire inflator**

for cars

▶ Item no. 9879-54-05

▶ PU: 1

▶ Item no. 9879-54-08 | Replacement hose

▶ PU: 1

▶ Technical specifications

- Calibrated (from the stamp date for two years)
- Filling pressure: max. 12 bar
- for cars / trucks
- Rubber protective cap protects the mechanics from external impacts
- Overpressure safety protection
- easy to read
- weight-optimized design
- Integrated kink protection stabilizes the filling hose at the outlet
- 500 mm long filling hose for valves that are difficult to access
- with hanging loop
- ergonomic design
- Single lever operation
- PTB approval



02

**Hand tire inflator**

with digital display, calibrated

▶ Item no. 9879-54-04

▶ PU: 1

▶ Item no. 9879-54-042 | Replacement hose

▶ PU: 1

▶ Technical specifications

- calibrated
- PTB approval
- modern, lightweight, shockproof construction
- clear and easy to read display
- Single stage valve design increases fill and drain speeds
- Overpressure warning if pressure exceeds 12 bar / 174 PSI / 1,200 kPa
- Low battery warning light
- Connection thread: 1/4 "IT
- Filling hose length: 180 cm
- max. inlet pressure: 15 bar
- max. filling time: 910 l / min
- Filling range: 0 - 12 bar
- Battery item number 3722-32 CR 2450
- Battery life: up to 950h
- System-bound software increases accuracy, fine measurement and eliminates the possibility of incorrect readings



03

**Gas station plug**

for hand tire inflator

▶ Item no. 9879-54-07

▶ PU: 1

▶ Technical specifications

- for hose inside diameter 7 mm
- Connection piece diameter 8 mm
- Length approx. 355 mm



04

**Valve lever connector**

for hand tire inflator

▶ Item no. 9879-54-06

▶ PU: 1

▶ Technical specifications

- for hose inside diameter 6 mm
- Total length approx. 40 mm
- Diameter of the valve inlet side approx. 18 mm
- Pin diameter: 7mm







01

**Zinc adhesive bar 45 g**

- ▶ Item no. 9834-14-745
- ▶ PU: 100

- ▶ Technical specifications
- Division: 3 x 5g 3 x 10g
- impact-resistant plastic coating
- Width: 19mm
- Height: 3.8 mm
- for almost all light alloy rims



02

**Zinc adhesive bar 60 g ECO**

- ▶ Item no. 9837-67-60
- ▶ PU: 100

- ▶ Technical specifications
- Division: 12 x 5g
- powder coated
- Width: 19mm
- Height: 4mm



03

**Zinc adhesive weight**

- ▶ Technical specifications
- from 25 g with one notch
- from 45 g with two notches
- impact-resistant plastic coating
- to facilitate molding to the rim radius
- OEM quality



Item No.	Weight	Width x Height	PU	Item No.	Weight	Width x Height	PU
9834-912-5	5 g	15 mm x 3,8 mm	100	9834-912-40	40 g	19 mm x 3,8 mm	50
9834-912-10	10 g	15 mm x 3,8 mm	100	9834-912-45	45 g	19 mm x 3,8 mm	50
9834-912-15	15 g	19 mm x 3,8 mm	100	9834-912-50	50 g	19 mm x 3,8 mm	50
9834-912-20	20 g	19 mm x 3,8 mm	100	9834-912-55	55 g	19 mm x 3,8 mm	50
9834-912-25	25 g	19 mm x 3,8 mm	100	9834-912-60	60 g	19 mm x 3,8 mm	50
9834-912-30	30 g	19 mm x 3,8 mm	100				
9834-912-35	35 g	19 mm x 3,8 mm	50				

04

**Zinc adhesive weight roll 5 kg**

- ▶ Item no. 9836-15-700
- ▶ PU: 1

- ▶ Technical specifications
- Endless adhesive weights
- with impact-resistant plastic coating
- Division: 1,000 x 5g
- Width: 19mm
- Height: 3.8 mm including adhesive tape
- Weight material: zinc
- Adhesive tape: High quality double-sided adhesive tape with blue liner
- Coating: high quality powder coating / uncoated, galvanized
- Corrosion resistance: ≥ 250h in the salt spray test according to DIN EN ISO 9227



05

**Cutting device for adhesive weight rolls**

- ▶ Item no. 9836-5
- ▶ PU: 1

- ▶ Technical specifications
- Cutting device for adhesive bars on rolls
- Scaling for weights with 5g and 2.5g
- easy operation of the knife
- Exchangeable knives
- easy wall mounting (front or side)
- Delivery without adhesive weight roll





01

**Steel glue bar silver, 60 g**

- ▶ **Technical specifications**
- unconnected individual weights
- no cutting edges when cutting off
- easy to remove even with gloves on
- galvanised with additional silver-grey powder coating
- 60 grams per strip (12 x 5 gram pieces)



Item No.	execution	Width x Height	PU
9833-397-60	Normfest	19 x 3,7 mm	100
9834-397-60	ECO	19 x 3,7 mm	100

02

**Steel adhesive bar black, 60 g**

- ▶ **Technical specifications**
- unconnected individual weights
- no cutting edges when cutting off
- easy to remove even when wearing gloves
- impact-resistant plastic coating
- 60 grams per strip (12 x 5 gram pieces)



Item No.	execution	Width x Height	PU
9833-97-60	Normfest	19 x 4 mm	100
9834-97-60	ECO	19 x 4 mm	100

03

**Steel adhesive weight roll 5 kg**

- ▶ **Item no. 9836-15-500**
- ▶ **PU: 1**
- ▶ **Technical specifications**
- Endless adhesive weights
- with impact-resistant plastic coating
- Division: 1,000 x 5g
- Width: 19mm
- Height: 3.5 mm including adhesive tape
- Weight material: steel
- Adhesive tape: High quality double-sided adhesive tape with blue liner
- Coating: high quality powder coating / uncoated, galvanized
- Corrosion resistance: ≥ 250h in the salt spray test according to DIN EN ISO 9227



04

**Steel adhesive weight roll 5 kg**

- ▶ **Item no. 9833-15-500 | silver**
- ▶ **Item no. 9833-97-500 | black**
- ▶ **Technical specifications**
- Adhesive steel weights on a roll for cutting off
- Galvanised with silver-grey or sharp powder coating
- Pitch: 1,000 x 5-gram segments
- Width: 19 mm
- Height: 3.5 mm incl. adhesive tape
- Weight material: steel



05

**Lead adhesive bar 40 g**

- ▶ **Item no. 9836-17-60**
- ▶ **PU: 50**
- ▶ **Technical specifications**
- Division: 8 x 5g
- Width: 10mm
- Height: 4.7 mm including adhesive tape
- for almost all light alloy rims

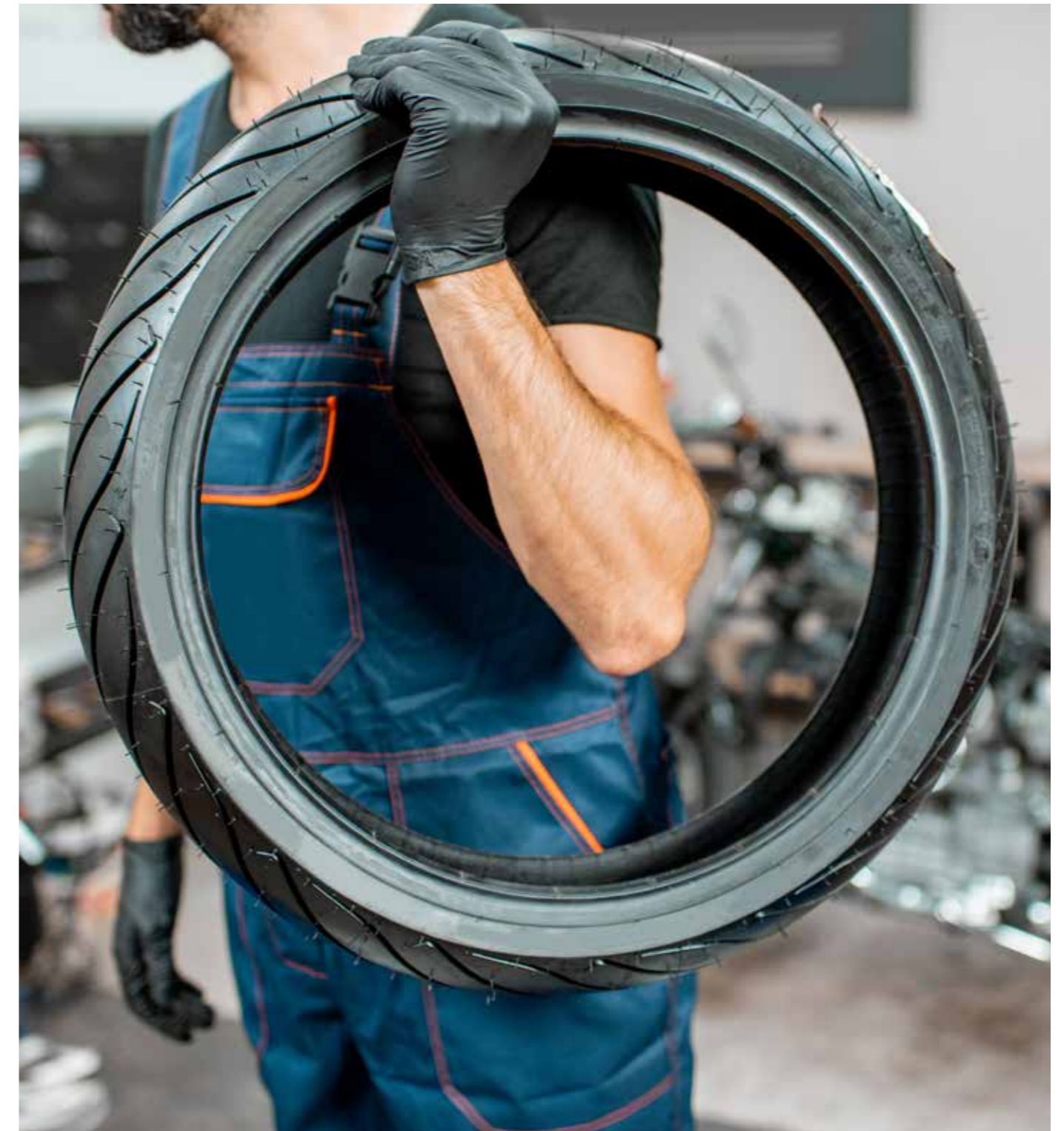

01

**Zinc impact weight**

universal for steel rims

## ► Technical specifications

- OEM quality
- impact-resistant plastic coating
- corresponds to the end-of-life vehicle regulation
- looks very good with steel rims
- absolutely impact resistant
- withstands salt spray test according to ISO 9227 / DIN 50021 SS

Item No.	Weight	PU	Item No.	Weight	PU
9836-1-5	5 g	100	9836-1-35	35 g	50
9836-1-10	10 g	100	9836-1-40	40 g	50
9836-1-15	15 g	100	9836-1-45	45 g	50
9836-1-20	20 g	100	9836-1-50	50 g	50
9836-1-25	25 g	100	9836-1-55	55 g	50
9836-1-30	30 g	100	9836-1-60	60 g	50



02

**Zinc impact weight**

universal for steel rims

## ► Technical specifications

- ECO quality
- powder coated
- corresponds to the end-of-life vehicle regulation

Item No.	Weight	PU	Item No.	Weight	PU
9837-5-5	5 g	100	9837-5-35	35 g	50
9837-5-10	10 g	100	9837-5-40	40 g	50
9837-5-15	15 g	100	9837-5-45	45 g	50
9837-5-20	20 g	100	9837-5-50	50 g	50
9837-5-25	25 g	100			
9837-5-30	30 g	100			



03

**Zinc impact weight**

universal for light alloy rims

## ► Technical specifications

- OEM quality
- impact-resistant plastic coating
- corresponds to the end-of-life vehicle regulation
- goes very well with light alloy rims
- absolutely impact resistant
- withstands salt spray test according to ISO 9227 / DIN 50021 SS

Item No.	Weight	PU	Item No.	Weight	PU
9836-3-5	5 g	100	9836-3-30	30 g	100
9836-3-10	10 g	100	9836-3-35	35 g	50
9836-3-15	15 g	100	9836-3-40	40 g	50
9836-3-20	20 g	100	9836-3-45	45 g	50
9836-3-25	25 g	100	9836-3-50	50 g	50



04

**Zinc impact weight**

universal for light alloy rims

## ► Technical specifications

- ECO quality
- powder coated
- corresponds to the end-of-life vehicle regulation

Item No.	Weight	PU	Item No.	Weight	PU
9837-3-5	5 g	100	9837-3-30	30 g	100
9837-3-10	10 g	100	9837-3-35	35 g	50
9837-3-15	15 g	100	9837-3-40	40 g	50
9837-3-20	20 g	100	9837-3-45	45 g	50
9837-3-25	25 g	100	9837-3-50	50 g	50





01

**Zinc impact weight**

for steel rims FORD type 187

## ► Technical specifications

- Original part from FORD Transit and FORD Transit Custom 05/2014



Item No.	Weight	PU	9836-187-35	35 g	50
9836-187-10	10 g	100	9836-187-40	40 g	50
9836-187-15	15 g	100	9836-187-45	45 g	50
9836-187-20	20 g	100	9836-187-50	50 g	50
9836-187-25	25 g	100	9836-187-55	55 g	50
9836-187-30	30 g	100	9836-187-60	60 g	50

Item No.	Weight	PU
----------	--------	----

02

**Zinc plug-in balance weight**

for Mercedes steel and aluminum rims, shape 75



Item No.	Weight	PU	9834-75-40	40 g	50
9834-75-5	5 g	100	9834-75-45	45 g	50
9834-75-10	10 g	100	9834-75-50	50 g	50
9834-75-15	15 g	100	9834-75-55	55 g	50
9834-75-20	20 g	100	9834-75-60	60 g	50
9834-75-25	25 g	100	9834-75-001	For aluminium wheel rims	100
9834-75-30	30 g	100	9834-75-002	for steel rim	100
9834-75-35	35 g	50			

Item No.	Weight	PU
----------	--------	----



03

**Zinc impact weight**

for steel rims type 164

## ► Technical specifications

- Original part from MERCEDES-BENZ Sprinter
- for steel rims of French vehicles
- for steel rims of light trucks (with greater material thickness of the rim)
- FORD Transit until 2013
- VW Crafter



Item No.	Weight	PU	9836-164-30	30 g	100
9836-164-5	5 g	100	9836-164-35	35 g	50
9836-164-10	10 g	100	9836-164-40	40 g	50
9836-164-15	15 g	100	9836-164-45	45 g	50
9836-164-20	20 g	100	9836-164-50	50 g	50
9836-164-25	25 g	100	9836-164-55	55 g	50

Item No.	Weight	PU	9836-164-60	60 g	50
----------	--------	----	-------------	------	----



04

**Lead impact weight**

for steep shoulder rims type 530

## ► Technical specifications

- 22.5 "x 6.75" to 26.50 "x 12.00"



Item No.	Weight	PU	9836-32-200	200 g	10
9836-32-50	50 g	10	9836-32-250	250 g	10
9836-32-75	75 g	10	9836-32-300	300 g	10
9836-32-100	100 g	10	9836-32-350	350 g	10
9836-32-150	150 g	10	9836-32-400	400 g	10

Item No.	Weight	PU
----------	--------	----

01

**Metal valve**  
for BMW

## ► Technical specifications

- Car rim valve
- Valve complete
- Version: brass, nickel-plated
- Suitable for all common alloy wheels with a rim hole diameter of 11.3mm (0.4mm)
- Recommended tightening torque 4-6 Nm
- Wrench size: 14
- Rim thickness: 1.8 mm
- Pressure range up to 14 bar
- Temperature resistance -30 ° C to 130 ° C (max. 150 ° C)

Item No.	Length	SW	PU
9879-563	43 mm	14 mm	10
9879-563-1	mit hoher Mutter	11 mm	10



03

**Metal valve**  
black, with high mother

- Item no. 9879-563-2
- PU: 20

## ► Technical specifications

- Valve hole diameter: 11.3 0.4mm
- Rim thickness: 1.8 - 4mm
- Valve length: 42mm
- Wrench size: 11mm
- Tightening torque: 4 -0.5Nm
- Pressure range: up to max. 14bar
- Valve complete
- easy assembly and disassembly
- Union nut fits over the valve cap
- Aluminum valve cap with seal
- Hexagon nut with clip seal
- prevents damage to the rim



- protects the rim
- black anodized
- permanent surface coating, no paint peeling
- Corrosion protection, since cap and body are made of the same material
- safe also for fast vehicles (over 210 km / h)
- Valve made of light metal (aluminum)
- light weight

02

**Metal valve**  
for vans, cars and vehicles with high tire pressure

## ► Technical specifications

- pressure load up to 14 bar
- Wrench size 11
- High temperature seal for peak temperatures above 150 ° C

Item No.	Length	SW	PU
9879-413-40	40 mm	11 mm	25
9879-414-47	47 mm	11 mm	25



04

**Rubber valves**  
for cars and motorcycles

## ► Technical specifications

- Snap-in tire valve
- approved up to 210 km / h
- Valve hole diameter (mm): 11.3 0.4
- Rim thickness: 1.8mm - 4mm
- Pressure range: <4.5 bar



Item No.	Length	execution	PU
9879-412	33 mm	OEM quality	50
9879-413	43 mm	OEM quality	100
9879-414	48 mm	OEM quality	100
9879-418	61 mm	OEM quality	100
9879-413-4	43 mm	ECO	100
9879-414-4	48 mm	ECO	100
9879-418-4	61 mm	ECO	100

06

**Metal valve**  
for tubeless commercial vehicle tires

## ► Technical specifications

- Rim valve for tubeless commercial vehicle tires with O-ring seal
- for steep shoulder rims
- Valve hole diameter: 9.7 0.3mm
- Rim thickness: 3.0mm - 6.0mm
- Tightening torque: 12 to 15 Nm
- Pressure range: <14 bar



Item No.	Length	Ø	PU
9879-800-41	41 mm	9,7 mm	1
9879-800-70	70 mm	9,7 mm	10

05

**Black rubber valve**  
Special valve for Ford

- Item no. 9879-414-2
- PU: 50

## ► Technical specifications

- approved up to 210 km / h
- Valve length: 56.6 mm
- Rim thickness: 1.8mm - 4mm
- ETRTO no. : V2.03.8
- TR No. : 414L
- Valve hole diameter (mm): 11.3 0.4
- Pressure range: <4.5 bar
- up to a speed of 210 km / h



07

**Metal / rubber valve**  
for vans and mobile homes

## ► Technical specifications

- secure sealing in the rim
- easy installation
- easy dismantling without special tools
- no rim damage during dismantling
- high pressure resistance
- Pressure load up to 7 bar
- Temperature resistant from -40 ° to 130 °
- Valve hole diameter: 11.3 0.4mm
- Rim thickness: 1.8mm - 4mm
- ETRTO no. : V0.07.3

Item No.	Length	PU
9879-530-40	40 mm	50
9879-530-47	47 mm	50
9879-530-60	60 mm	50





01  
**Plastic valve extension**  
black

- ▶ Item no. 9879-71 | 19 mm
- ▶ PU: 20
  
- ▶ Item no. 9879-73 | 38 mm
- ▶ PU: 20



02  
**Valve insert**  
short version

- ▶ Item no. 9879-44
- ▶ PU: 20
  
- ▶ Technical specifications
- Material: nickel-plated brass
- Opening pressure: 3 bar / - 25%
- Working pressure: <20 bar
- Tightening torque: 25 - 30 Ncm



03  
**Valve cap**  
metal

- ▶ Item no. 9879-46
- ▶ PU: 50



- ▶ Technical specifications
- Round head valve cap made of nickel-plated brass with seal
- prevents corrosion on the valve thread

04  
**Key valve cap**  
metal

- ▶ Item no. 9879-47
- ▶ PU: 50



- ▶ Technical specifications
- prevents corrosion on the valve thread
- made of nickel-plated brass with seal
- with extractor for valve insert

05  
**Extension cap with seal**  
check valve

- ▶ Item no. 9879-66
- ▶ PU: 25



- ▶ Technical specifications
- unscrewing is not necessary for filling or pressure testing
- insensitive to dirt and water
- prevents pressure loss even if the valve insert is damaged or dirty
- fits every standard valve

06  
**Valve cap**  
plastic

- ▶ Technical specifications
- without seal
- has the necessary strength to seal
- can be dismantled even under difficult conditions
- does not become soft or cracked in warm temperatures



Item No.	colour	PU
9879-45	black	50
9879-48	red	50

07  
**Screwing in and out tool**  
for all common valves

- ▶ Item no. 9879-54-00
- ▶ PU: 1
  
- ▶ Technical specifications
- Tightening torque: approx. 25-30 Nm



08  
**Adhesive weight remover**  
plastic

- ▶ Item no. 8715-64-80
- ▶ PU: 1



- ▶ Technical specifications
- For loosening glued trim strips on the body and on the rims

09  
**Valve retraction lever**  
Plastic coating

- ▶ Item no. 9879-54-041
- ▶ PU: 1



- ▶ Technical specifications
- Length: 290 mm

10  
**Valve extension**  
Air-Flexx



- ▶ Technical specifications
- Steel, flexible

Item No.	Length	PU
9879-700-145	145 mm	6
9879-700-185	185 mm	6
9879-700-215	215 mm	6



11  
**Valve extension**  
with support tube

- ▶ Technical specifications
- Plastic, rigid

Item No.	Length	PU
9879-74	115 mm	20
9879-75	150 mm	20
9879-76	170 mm	20



Item No.	execution	PU	Image
5500-110-31	Wheel bolt geometric M12 x 1,5 x 20 SW12 silver	25	
6362-112-15	Wheel nut M12 x 1,5 SW 21 VZG-3	50	
6395-012-15	Wheel nuts Mazda, Mitsubishi, Toyota OE-Nr. Mazda 0603-26-161 OE-Nr. Mitsubishi MA103087 OE-Nr. Toyota 90942-01001-83 M12 x 1,5 yellow passivated, grade 8, width across flats 21	100	
6395-12-15	Wheel bolt OE-Nr. 1007487, 6040307, 1447852, M12 x 1,5 zinc plated, grade 8, width across flats 19	100	
6395-12-151	Wheel bolt OE-Nr. 1470843, M12 x 1,5 zinc plated, grade 10, width across flats 19	50	
6395-214-15	Wheel bolt Volkswagen / Audi OE-Nr. 8D0 601 139 D, M14 x 1,5 x 25,5 geomet black, grade 8.8, width across flats 17	50	



## 02

**Rim protection**

for tire mounting machines

- ▶ Item no. 9879-990
- ▶ PU: 5

## ▶ Technical specifications

- suitable for quad, motorcycle and car rims
- Absolutely necessary for aluminum rims
- to protect the rim edge during assembly
- robust design
- soft plastic
- Length: 15 cm
- Length of the cord: 35 cm



## 03

**Tyre bags**

## ▶ Technical specifications

- 100 sheets per roll
- 30µ
- for the appropriate storage of tires
- Protection from exposure to light

Item No.	Size
7875-906	700 x 260 x 1,000 mm
7875-909	700 x 500 x 1,200 mm





01

**Speed sticker**

Note on the maximum permissible speed after changing wheels

► **Technical specifications**

- Customer information for the vehicle interior
- can be removed without leaving any residue
- lightfast, heat-resistant
- in a practical cardboard dispenser box
- 25 mm diameter
- 100 pieces per roll

Item No.	execution	PU
7410-004-012	190 km/h	100
7410-004-013	210 km/h	100
7410-004-014	240 km/h	100



02

**Wheel bolt bag**► **Technical specifications**

- Wheel bolt bags made of 100% cotton
- with drawstring
- for the clever storage of wheel nuts with every tire change
- can be used several times
- Format: 170 x 200 mm
- PU = 100 pieces

Item No.	execution	PU
7410-003-004	Colour: natural	100
7410-003-003	Colour: black	100









**01**  
**Multipurpose primer**  
1K multi-connector

- ▶ Item no. 2893-900
- ▶ colour: light grey
- ▶ Content: 400 ml
- ▶ Quantity per box: 12



- ▶ Item no. 2893-900-20
- ▶ colour: dark grey
- ▶ Content: 400 ml
- ▶ Quantity per box: 12



- ▶ **Technical specifications**
- very good adhesion promoter and rust protection spray in one
- is ideal as a primer on galvanized surfaces, aluminum, steel, various plastics and wood
- after a skin has formed, it can be painted over „wet on wet“ without intermediate sanding
- has a good filling capacity and thus compensates for slight unevenness
- Can be painted over without intermediate sanding
- with fan spray head
- Insulates the edge zones of putty spots particularly well



**02**  
**Primer with rust stop function**  
1K Epoxy

- ▶ Item no. 2893-907-2
- ▶ colour: white
- ▶ Content: 400 ml
- ▶ Quantity per box: 6



- ▶ Item no. 2893-907
- ▶ colour: grey
- ▶ Content: Starter Set
- ▶ Quantity per box: 6



- ▶ Item no. 2893-907-1
- ▶ colour: for 1001-179-6
- ▶ Content: 400 ml
- ▶ Quantity per box: 6



- ▶ **Technical specifications**
- good adhesive properties on all metals, various plastics and GRP
- excellent rust protection properties
- high opacity
- fast drying
- wet on wet application under filler
- sandable after 20 min
- Can be painted over with all commercially available 1K and 2K solvent and water-based top coats
- Epoxy based and silicone remover resistant
- temperature resistant up to 95 ° C
- especially for small damage repairs up to spot repairs
- Insulating effect against moisture
- high paint application rate
- constant atomizer pressure until the can is emptied
- professional painting result
- very high filling capacity due to 23.1% solids content
- according to DIN53150



01

**Primer filler**

2K epoxy

- ▶ Item no. 2800-760
- ▶ colour: beige
- ▶ Content: 400 ml
- ▶ Quantity per box: 6

▶ **Technical specifications**

- Degree of gloss: matt
- Color beige
- Long-lasting corrosion protection on all surfaces, e.g. zinc, aluminum, steel, etc.
- Solids content: 50-53% by weight based on diluted paint (without propellant)

02

**Basic primer**

Baso Plus

- ▶ Item no. 2893-889
- ▶ colour: light grey
- ▶ Content: 400 ml
- ▶ Quantity per box: 24

▶ **Technical specifications**

- high filling capacity
- contains an anti-rust agent
- is very suitable for priming iron surfaces
- temperature resistant up to 100 ° C
- Can be painted over with nitro, acrylic and water-based paint
- Fan spray head enables vertical and horizontal application of the primer
- do not paint on surfaces painted with synthetic resin

03

**Thick film filler**

1K filler

- ▶ Item no. 2893-902-1
- ▶ Content: 400 ml
- ▶ Quantity per box: 6

▶ **Technical specifications**

- high solids content
- good corrosion protection thanks to active rust protection pigments
- good adhesive properties on steel, galvanized steel, aluminum and various plastics such as hard PVC, PPO / PA, ABS, PC / PBT
- excellent filling capacity
- very high stability
- quick-drying (dust-dry: 3min, touch-proof: 8min and sandable: 20min)
- 30 µm layer thickness can be sanded dry after 20 minutes at 20 degrees Celsius
- Can be painted over with commercially available 1K and 2K solvent- and water-based topcoats
- temperature resistant up to approx. 90 ° C
- In any case, check for compatibility
- Equipped with a round jet nozzle (spray pattern analogous to the paint gun)

04

**2 component primer filler**

2K Rapid Filler

- ▶ Item no. 2893-905
- ▶ Content: 400 ml
- ▶ Quantity per box: 6

▶ **Technical specifications**

- isocyanate free
- very fast drying after 1 hour at 20 ° C
- or after 15-20 minutes at 60 ° C
- Can be painted over: after 20 minutes air drying
- Can be sanded after 1 hour at 20 ° C or 30 minutes at 60 ° C
- Universally applicable on sanded old paintwork and metallic surfaces
- simple, time-saving processing
- very high filling capacity
- very good adhesion to bare steel / sheet metal
- Can be painted over with all common 1K and 2K topcoat systems





01

**Fiberglass spatula**

Compound

- ▶ Item no. 2893-109-9
- ▶ Content: 1.8 kg
- ▶ Quantity per box: 6

## ▶ Technical specifications

- for filling in larger dents
- adheres to roughened and metallic surfaces as well as to many plastics
- including hardener (Art.-No. 2893-139)



02

**Multisoft spatula**

Multi

- ▶ Item no. 2893-101-9
- ▶ Content: 2 kg
- ▶ Quantity per box: 6

## ▶ Technical specifications

- suitable for filling small to medium-sized depressions
- very good adhesive properties on different metallic surfaces
- including hardener (Art.-No. 2893-139)



03

**Universal spatula**

University

- ▶ Item no. 2893-106-9
- ▶ Content: 2 kg
- ▶ Quantity per box: 6

## ▶ Technical specifications

- for filling in smaller areas, bumps and grooves
- adheres to aluminum, plastics and steel (not to galvanized steel)
- including hardener (Art.-No. 2893-139)

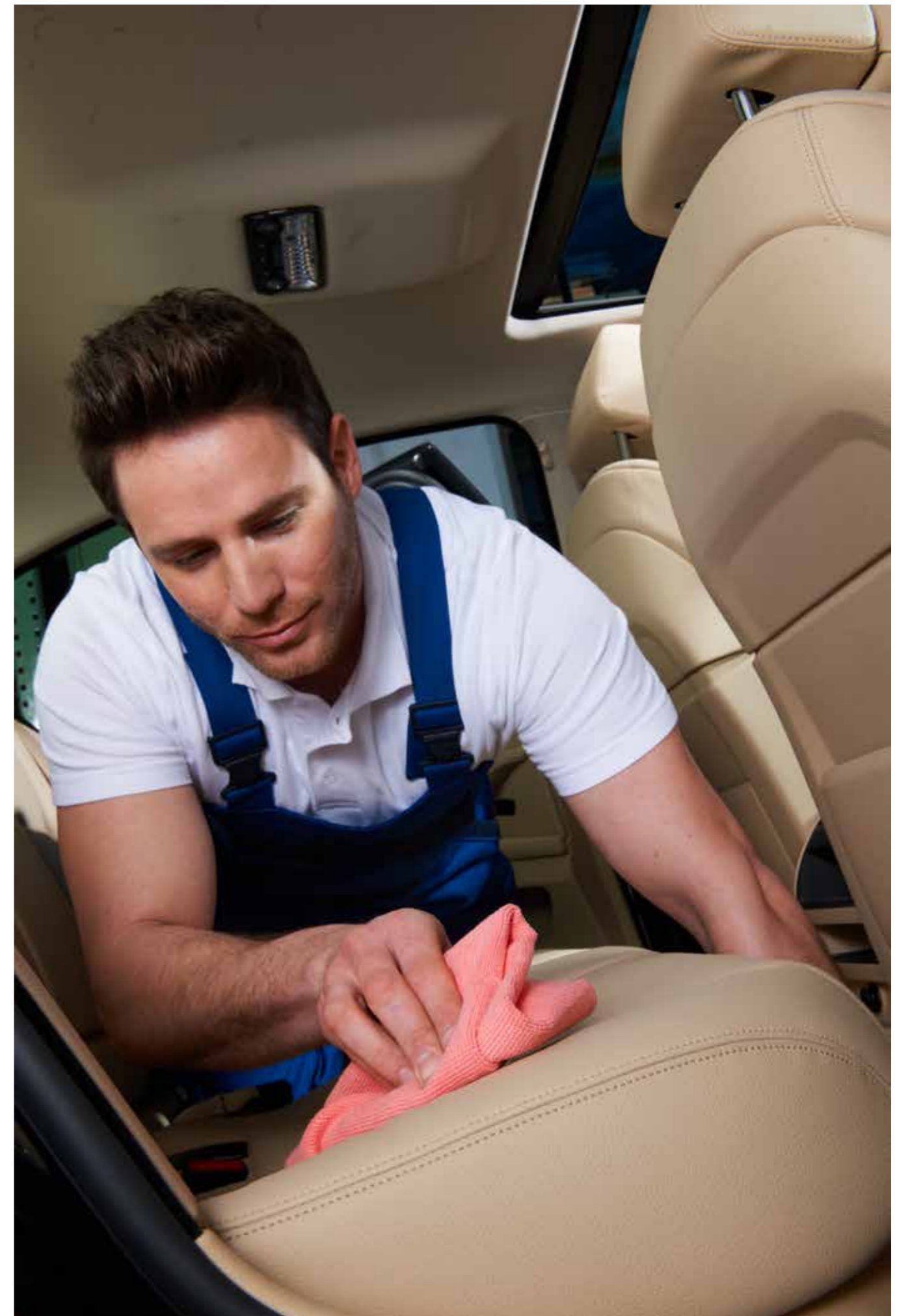

01

### Fine spatula finish

- ▶ Item no. 2893-112-9
- ▶ Content: 2 kg
- ▶ Quantity per box: 6
- ▶ Technical specifications
  - for filling in smaller areas, bumps and grooves
  - adheres to aluminum, plastics, steel and galvanized steel
  - including hardener (Art.-No. 2893-139)



02

### Aluminum spatula Alu

- ▶ Item no. 2893-103-9
- ▶ Content: 1.8 Kg
- ▶ Quantity per box: 6
- ▶ Technical specifications
  - for filling large recesses and parts that are exposed to vibrations or oscillations
  - adheres to aluminum, plastics, steel and galvanized steel
  - including hardener (Art.-No. 2893-139)



03

### Harder Replacement tube

- ▶ Item no. 2893-139
- ▶ Content: 50 g
- ▶ Quantity per box: 10
- ▶ Technical specifications
  - for use with all Normfest leveling compounds



04

### Japan spatula set for the professional application of our fillers

- ▶ Item no. 8715-65-00
- ▶ Technical specifications
  - 4 parts
  - Acid-proof plastic back



05

### Smoothing spatula

- ▶ Item no. 2893-164
- ▶ PU: 10
- ▶ Technical specifications
  - made of plastic







01  
**Fineloc Velcro discs**  
with Velcro back

- ▶ Technical specifications
- for sanding out scratches and paint runs

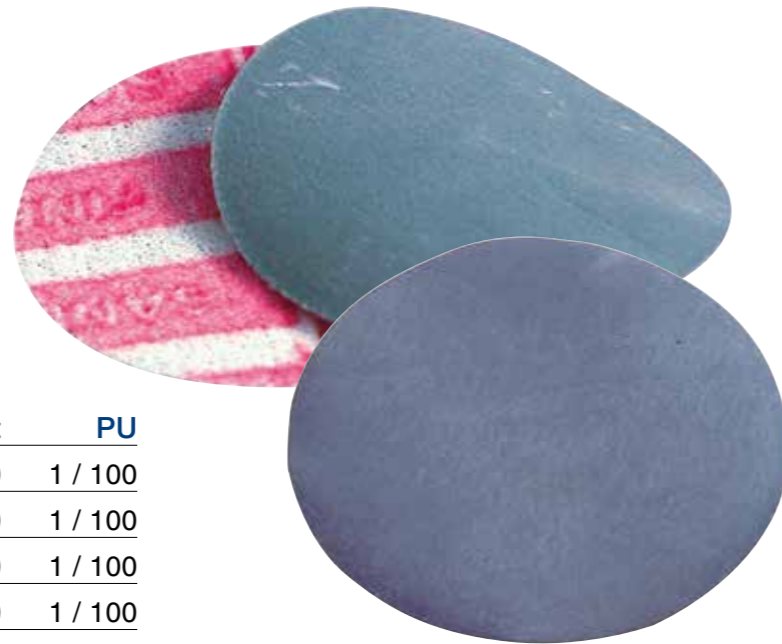

Item No.	Ø mm	Grit	PU
4679-31-150	30	1.500	1 / 100
4679-31-200	30	2.000	1 / 100
4679-33-150	75	1.500	1 / 100
4679-33-200	75	2.000	1 / 100

02  
**Hand grinder**  
Ø 30mm

- ▶ Item no. 4679-90-91
- ▶ Technical specifications
- Holder for abrasive flowers with Velcro back



03  
**Normloc recording system**  
including shaft 6 mm

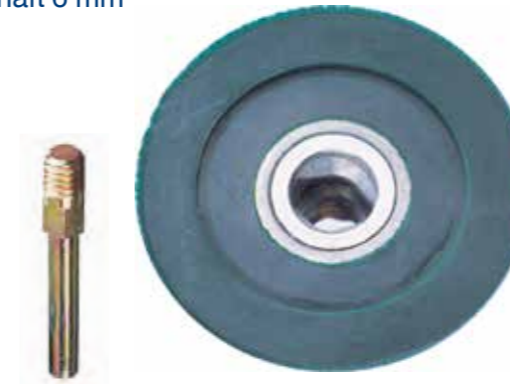

Item No.	Ø mm	max.rpm	PU
4679-90-94	30	40.000	1
4679-90-92	50	30.000	1
4679-90-93	75	20.000	1

05  
**Mounting shaft Normloc**  
Ø 6mm

- ▶ Item no. 4679-99-6



07  
**Velcro attachment**  
Ø 75 mm

- ▶ Item no. 4679-91-93



04  
**3M recording system**  
Ø 75mm, for Bristle Disc

- ▶ Item no. 4679-90-931



06  
**adapter**  
for angle grinder (8696-1-80)

- ▶ Item no. 4679-99-8
- ▶ Technical specifications
- M14 internal thread
- For mounting the Normloc mounting system on an angle grinder



08  
**Polishloc lambskin hood**  
Ø 75 mm

- ▶ Item no. 4679-43



01

**Foil eraser ECO**

with shaft

- ▶ Item no. 4585-100-0
- ▶ PU: 1

## ▶ Technical specifications

- Ø 88 mm
- Thickness 15 mm
- Shank thread M8
- Shaft length approx. 30 mm



02

**Foil eraser**

with shaft

- ▶ Item no. 4585-100-2
- ▶ PU: 1

## ▶ Technical specifications

- Ø 100 mm
- Thickness 15 mm
- Shank thread M10



03

**Drill adapter for rubber disc**

for foil eraser

- ▶ Item no. 4585-100-3
- ▶ PU: 1



04

**Foil eraser Wave**

with shaft

- ▶ Item no. 4585-100-4
- ▶ PU: 1

## ▶ Technical specifications

- Thread M8
- effortlessly removes residues from adhesive tape, foil lettering, decorative strips, rim weight, etc.
- The corrugated profile ensures increased application safety through self-cooling
- When used properly, the WAVE foil eraser is very gentle on paintwork
- for professional use in vehicle preparation, in vehicle workshops and in paint shops





01

**Velcro grinding wheel**

ø 150 mm - Norton Multi-Air, 181 holes punched - Norgrip

- Technical specifications
- 181-hole punched

Item No.	Ø mm	Grit	PU
4651-080	150	80	1 / 100
4651-012-0	150	120	1 / 100
4651-015-0	150	150	1 / 100
4651-018-0	150	180	1 / 100
4651-022-0	150	220	1 / 100
4651-024-0	150	240	1 / 100
4651-032-0	150	320	1 / 100
4651-036-0	150	360	1 / 100
4651-040-0	150	400	1 / 100
4651-050-0	150	500	1 / 100
4651-060-0	150	600	1 / 100
4651-080-0	150	800	1 / 100

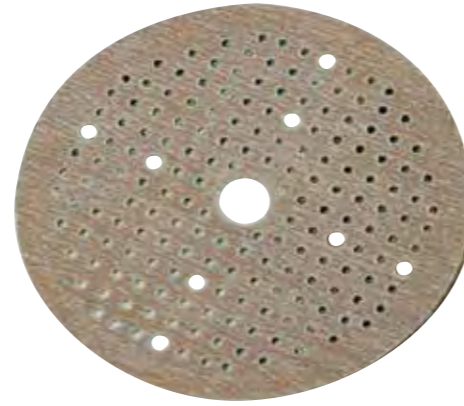

02

**Velcro grinding wheel**

ø 150 mm - Norton Multi-Air - perforated 181 times - Soft

- Technical specifications
- 181-hole punched

Item No.	Ø mm	Grit	PU
4651-320	150	320	1 / 20
4651-400	150	400	1 / 20
4651-500	150	500	1 / 20
4651-800	150	800	1 / 20
4651-100-0	150	1000	1 / 20
4651-150-0	150	1500	1 / 20

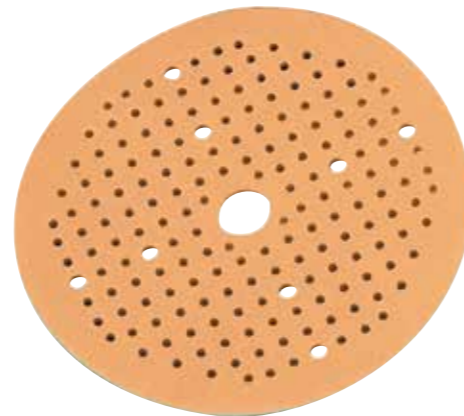

03

**Sandpaper gold with Velcro**

ø 150 mm - gold, Mirka, 7 holes, Hutchinson

- Technical specifications
- 6 perforated once
- flexible and aggressive
- high quality universal product
- Grain type: aluminum oxide
- Binder: synthetic resin, progressive bond
- Backing material: flexible latex paper
- Scatter: half-open
- Color gold

Item No.	Ø mm	Grit	PU
4657-080	150	80	1 / 100
4657-010-0	150	100	1 / 100
4657-012-0	150	120	1 / 100
4657-018-0	150	180	1 / 100



01

**Velcro discs**

ø 150 mm, Mirka Gold, perforated 15 times

Item No.	Grit	PU
4615-040	40	1 / 50
4615-060	60	1 / 50
4615-080	80	1 / 100
4615-010-0	100	1 / 100
4615-012-0	120	1 / 100
4615-015-0	150	1 / 100
4615-018-0	180	1 / 100
4615-022-0	220	1 / 100
4615-024-0	240	1 / 100
4615-032-0	320	1 / 100
4615-040-0	400	1 / 100
4615-050-0	500	1 / 100

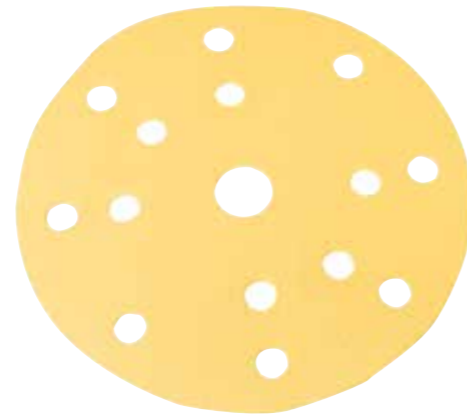

02

**Velcro discs**

ø 150 mm, standard, 15 holes perforated

Item No.	Grit	PU
4515-040	40	50
4515-060	60	50
4515-080	80	100
4515-010-0	100	100
4515-012-0	120	100
4515-015-0	150	100
4515-018-0	180	100
4515-022-0	220	100
4515-024-0	240	100
4515-032-0	320	100
4515-040-0	400	100
4515-050-0	500	100

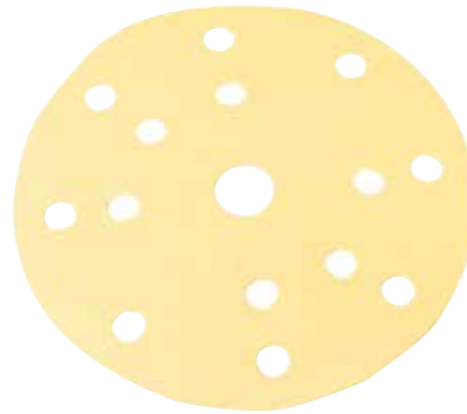

03

**Eccentric sander**

► Item no. 8696-530-003

## ► Technical specifications

- Max. Speed: 10,000 rpm
- Sanding stroke: 2.5 mm
- Hole diameter: 5 mm
- Weight: 900g
- Vibrations: 2.5 m / s<sup>2</sup>
- Air consumption: 45 l / min
- Sound power level: 80 dB
- Length: 248 mm
- incl. plug nipple with 1/4 „male thread



04

**Abralon™ grinding wheels**

Diameter 150 mm, medium

## ► Technical specifications

- Ø 150mm
- Grit 360
- unperforated
- extreme flexibility
- quickly creates a smooth, uniform surface finish, even on contours
- accelerates polishing operations

Item No.	Ø mm	Grit	PU
4587-360	150	360	1 / 20
4587-500	150	500	1 / 20
4587-600	150	600	1 / 20
4587-100-0	150	1000	1 / 20
4587-200-0	150	2000	1 / 20
4587-300-0	150	3000	1 / 20
4587-400-0	150	4000	1 / 20

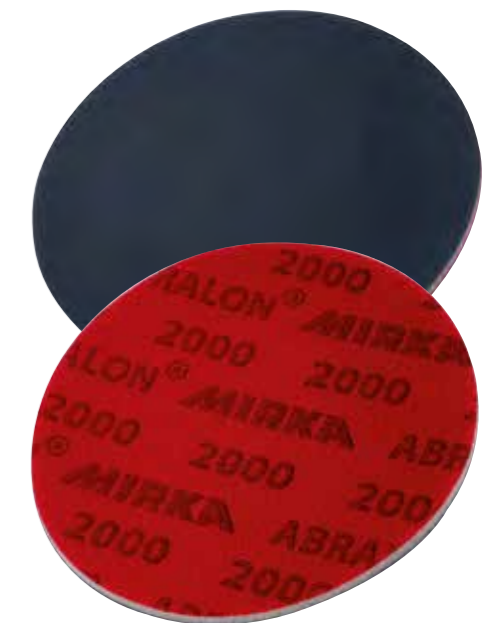



01

**Sanding disc Velcro Norton Multi-Air**  
 ø 150 mm

## ▶ Technical specifications

- The innovative multi-air back pad design sucks dust into a collection chamber that provides optimal airflow and powerful dust extraction. High performance, high productivity and a clean surface and working environment are the result of this innovative design.
- Fields of application:
- Steel
- Non-ferrous metals
- Wood and chipboard
- Plastics and composites
- Paints and varnishes
- Dry construction and plaster
- Stainless steel
- Tiles and natural stone



Item No.	execution	Ø mm	PU
4666-150-3	medium	150	1
4666-150-4	soft	150	1

02

**Velcro sanding pad Multi**  
 Ø 150 mm, medium hard

## ▶ Item no. 4666-150-69

## ▶ Technical specifications

- Sanding pad series E with dust extraction
- Extraction with all standard hole patterns
- Contact surface for Velcro systems or self-adhesive sandpaper
- Micro Velcro

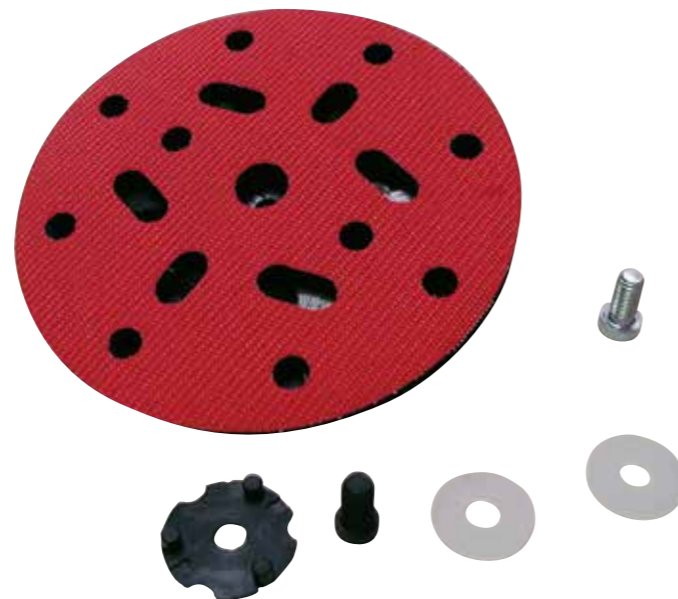

03

**Sanding mouse, hand sanding block**  
 Grinding mouse

## ▶ Item no. 4662-100

## ▶ Technical specifications

- for 150 mm Velcro discs
- lightweight
- made of plastic



01

**Slide paper**

yellow

## ► Technical specifications

- Strip 115mm x 280mm
- 10-hole punched
- without adhesion
- flexible sandpaper openly scattered
- for pre- and intermediate sanding in the painting area with vibration sander or by hand
- Grit type: aluminium oxide
- Binder: Synthetic resin, Progressive resin
- Base material: Flexible latex paper
- Scattering: semi-open



Item No.	Grit	PU
4676-060	60	1 / 50
4676-080	80	1 / 100
4676-012-0	120	1 / 100

02

**Slide paper**

yellow

## ► Technical specifications

- Strip 115mm x 280mm
- unperforated
- without adhesion
- flexible sandpaper openly scattered
- for pre- and intermediate sanding in the painting area with vibration sander or by hand
- Grit type: aluminium oxide
- Binder: Synthetic resin, Progressive resin
- Base material: Flexible latex paper
- Scattering: semi-open



Item No.	Grit	PU
4676-40	40	1 / 50
4676-60	60	1 / 50
4676-80	80	1 / 100
4676-100	100	1 / 100
4676-120	120	1 / 100
4676-150	150	1 / 100
4676-180	180	1 / 100
4676-240	240	1 / 100

03

**Slider Paper Roll**

unperforated

## ► Technical specifications

- Length: 50 m
- Width: 115 mm
- Grain type: Aluminium oxide
- Colour: Bluish
- Backing material: D-paper / C-paper / B-paper
- Binder: Solid synthetic resin
- Spreading: Semi-open



Item No.	Grit	PU
4677-104-0	40	1
4677-106-0	60	1
4677-108-0	80	1
4677-110-0	110	1
4677-112-0	120	1
4677-115-0	150	1
4677-118-0	180	1
4677-124-0	240	1

04

**Emery cloth dispenser**

unequipped

## ► Item no. 7100-002-07

## ► Technical specifications

- Dispenser for up to three emery cloth rolls, for attachment to perforated panels.

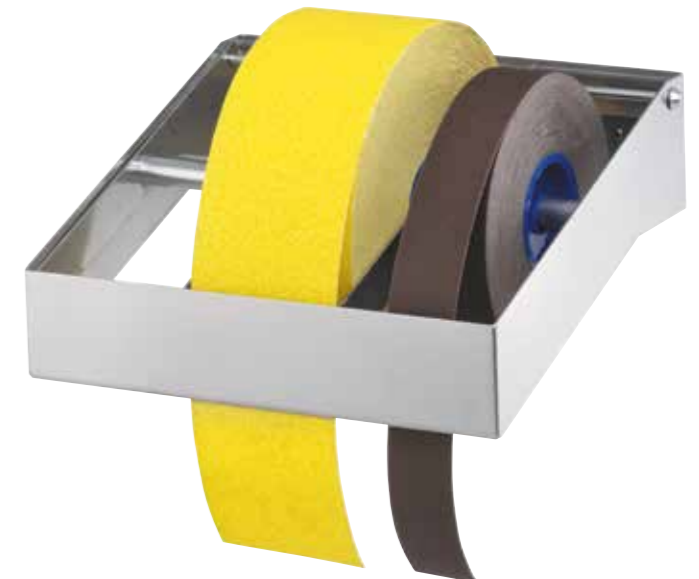



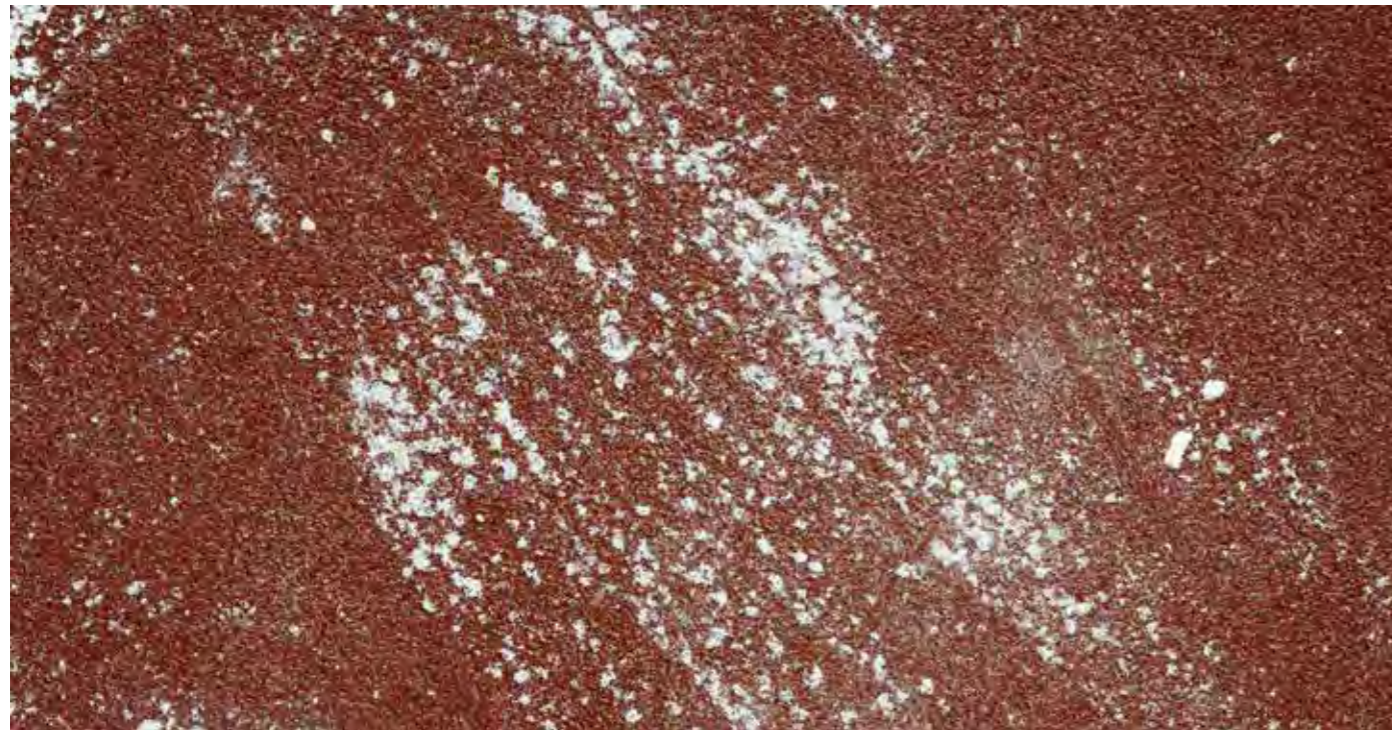

02

**Emery cloth**

blue, sheet 230 x 280 mm

Item No.	Grit	PU
4671-40	40	1 / 25
4671-60	60	1 / 25
4671-80	80	1 / 25
4671-120	120	1 / 25
4671-180	180	1 / 25

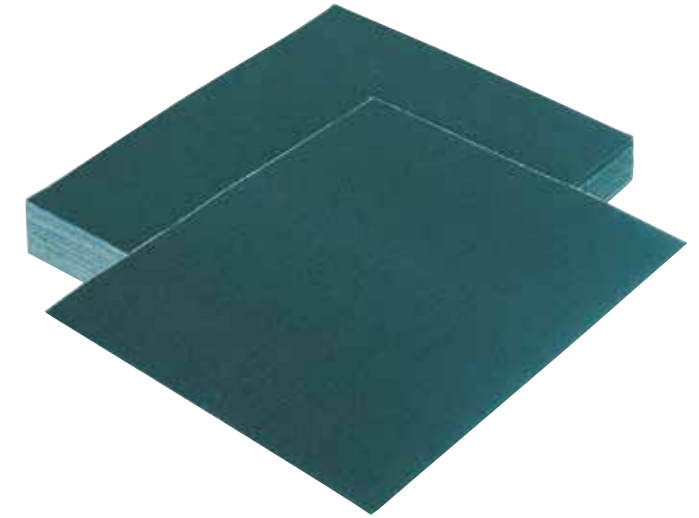

01

**Emery cloth roll**



Item No.	Grit	Width (mm)	Length [m]
4674-40-40	40	40	25
4674-40-60	60	40	25
4674-40-80	80	40	25
4674-40-100	100	40	25
4674-40-120	120	40	25
4674-40-240	240	40	25
4674-40-400	400	40	25
4674-50-40	40	50	25
4674-50-60	60	50	25
4674-50-80	80	50	50
4674-50-100	100	50	50
4674-50-120	120	50	50
4674-50-180	180	50	50
4674-50-240	240	50	50
4674-50-400	400	50	50

03

**Soft sandpaper rolls**

115 mm x 20 m

Item No.	Grit	PU
4586-150	150	1
4586-180	180	1
4586-220	220	1
4586-240	240	1
4586-280	280	1
4586-320	320	1
4586-400	400	1
4586-500	500	1
4586-600	600	1
4586-800	800	1





01

**File strips**

70 mm x 420 mm

► **Technical specifications**

- for the quick removal of old paintwork, sanding of fillers and flattening of sharp edges and rough surfaces
- with extremely strong grain adhesion
- very long service life
- flexible and tear-resistant



Item No.	Grit	Illustration	PU
4652-60	60	1	50
4652-80	80	2	100
4652-120	120	3	100

02

**Embroidery strips unperforated**

70 x 450 mm

► **Technical specifications**

- Grain type: Aluminium oxide Binder: Synthetic resin Support material: Flexible latex paper Scattering: Semi-open Colour: Gold Flexible and aggressive



Item No.	Grit	PU
4678-40	40	50
4678-80	80	50
4678-120	120	100

03

**File block**

for file strips

► **Item no. 4652-70-400**

► **Technical specifications**

- the ergonomic shape ensures easy and fatigue-free handling
- The molded plastic body ensures a high level of resistance and durability
- with valve to regulate the suction force and optimize the air / dust extraction



04

**Carbon sanding blocks**

\*\*\*???\* AGWBL Subheadline:1

► **Technical specifications**

- for removing scratches and aligning paint structures

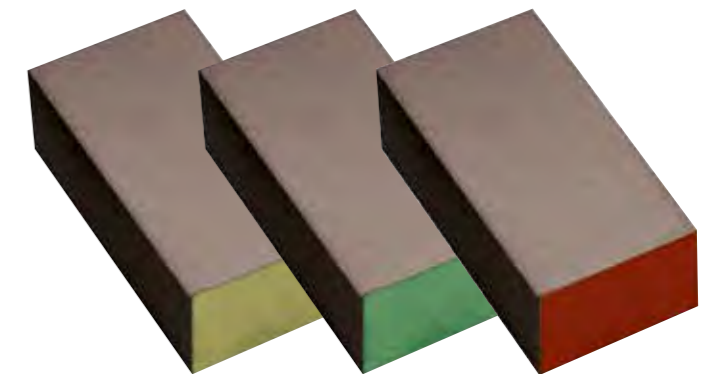

Item No.	Grit	colour
4675-001-500	1500	yellow
4675-002-000	2000	green
4675-003-000	3000	red



01

**waterproof wet sandpaper**

Sheet 230 mm x 280 mm

## ► Technical specifications

- for fine sanding work before polishing
- for all wet sanding work
- Sheet 230mm x 280mm
- waterproof



Item No.	Grit	PU
4673-80	80	1 / 50
4673-120	120	1 / 50
4673-180	180	1 / 50
4673-240	240	1 / 50
4673-320	320	1 / 50
4673-360	360	1 / 50
4673-400	400	1 / 50
4673-600	600	1 / 50
4673-800	800	1 / 50
4673-100-0	1000	1 / 50
4673-120-0	1200	1 / 50
4673-150-0	1500	1 / 50
4673-200-0	2000	1 / 50

02

**Waterproof wet sandpaper 3M**

Sheet 230 x 280 mm? Waterproof



Item No.	Grit	PU
4685-240	240	1 / 25
4685-320	320	1 / 25
4685-500	500	1 / 25

03

**Abrasive fleece**

very fine, red

## ► Technical specifications

- Grain size 360
- High flexibility
- more performance due to innovative spreading
- for wet and dry applications
- Grit type: aluminium oxide very fine
- Binder: synthetic resin
- Carrier material: non-woven
- Scattering: total coating, three-dimensional
- Colour: red



Item No.	execution	Grit	PU
4585-451-10	Roll 115 mm x 10 m	360	1
4585-451	Pads 152 mm x 229 mm	360	20

04

**Abrasive fleece**

ultra fine, gray

## ► Technical specifications

- Grit 1,500
- high flexibility
- more performance through innovative distribution
- for wet and dry applications
- also for animal hair
- Grain type: aluminum oxide ultra fine
- Binder: synthetic resin
- Backing material: fleece
- Scattering: Total Coating, three-dimensional
- Color gray



Item No.	execution	Grit	PU
4585-455-10	Roll 115 mm x 10 m	1500	1
4585-455	Pads 152 mm x 229 mm	1500	20

01

**Masking paper**

fully glued

## ► Technical specifications

- Quality tested according to DIN
- high paint density
- smooth on one side
- guaranteed run length
- Attention: for lacquers with a viscosity <19 sec. Carry out a lacquer test beforehand, possibly double-mask the edges with 20 cm paper.

Item No.	Width (mm)	Length [m]	PU
7875-800-022	20	300	1
7875-800-060	60	300	1
7875-800-090	90	300	1
7875-800-120	120	300	1
7875-800-150	150	300	1



02

**Foam Plus foam profile**

self-adhesive

Item No.	Width (mm)	Length [m]	PU
4582-13	13	50	1
4582-17	19	40	1



03

**Paint protection hood**

25 tear-offs

## ► Item no. 7875-912

► Format: 630 x 400 cm

## ► Technical specifications

- 25 tear-offs
- Dimensions: 630 cm x 400 cm



04

**Rim paint protection film**

30 demolitions

## ► Item no. 7875-918

► Format: 130 cm x 130 cm

## ► Technical specifications

- Original Wondermask® WPS
- excellent protection from paint mist
- considerable time





01

**Paint protection film**

9 μ, 5 m x 150 m

- ▶ Item no. 7875-914
- ▶ Format: 5 m x 150 m

## ▶ Technical specifications

- Installation only on absolutely dry vehicles!
- Thickness: 9μ
- static
- paint-sticking
- can be painted over
- Infrared resistant
- Material: HDPE
- heat-resistant up to 110 ° C
- Avoid exposure to UV radiation!



02

**Paint protection film**

9 μ, 4 m x 300 m

- ▶ Item no. 7875-915
- ▶ Format: 4 m x 300 mm

## ▶ Technical specifications

- Installation only on absolutely dry vehicles!
- Thickness: 9μ
- static
- paint-sticking
- can be painted over
- Infrared resistant
- Material: HDPE
- heat-resistant up to 110 ° C
- Avoid exposure to UV radiation!



03

**Paint protection film**

15 μ, 4 m x 200 m

- ▶ Item no. 7875-917
- ▶ Format: 4 x 200 m

## ▶ Technical specifications

- Can be installed on damp vehicles
- Thickness: 15μ
- highly flexible and tear-resistant
- extremely good paint adhesion
- waterproof
- suitable for all vehicle types
- Micropore-proof, therefore 100% lacquer-impermeable
- very good cutting behavior
- Dust and dirt retention through static charge
- Tensile strength along 24 N / mm<sup>2</sup>
- Tensile strength across 17 N / mm<sup>2</sup>
- heat-resistant up to 110 ° C



04

**Cutter knife**

- ▶ Item no. 7875-917-1

## ▶ Technical specifications

- for cutting paint protection films and masking paper





01

**Waterproof masking tape**

Color green

- ▶ Technical specifications
- Heat-resistant for up to one hour at 130 ° C
- Roll length: 50 meters
- silicone free
- Sharp-edged, clean and precise masking
- suitable for waterborne paint systems
- excellent adhesive strength on rubber and metal
- easy to remove without leaving any sticky residue
- The adhesive consists of solvent-based rubber



Item No.	Width (mm)	Length [m]	PU	Quantity per box
4992-940	19	50	1	48
4992-941	25	50	1	36
4992-942	38	50	1	24
4992-943	50	50	1	24

02

**Contour tape**

50 meter rolls

- ▶ Item no. 4585-12
- ▶ Quantity per box: 24
  
- ▶ Technical specifications
- for masking doors when painting
- no Residues
- weatherproof
- temperature resistant up to 120 ° C for 1 hour
- adapts to every curve shape
- without wrinkling
- Width: 19mm
- Length: 50 m
- Color yellow

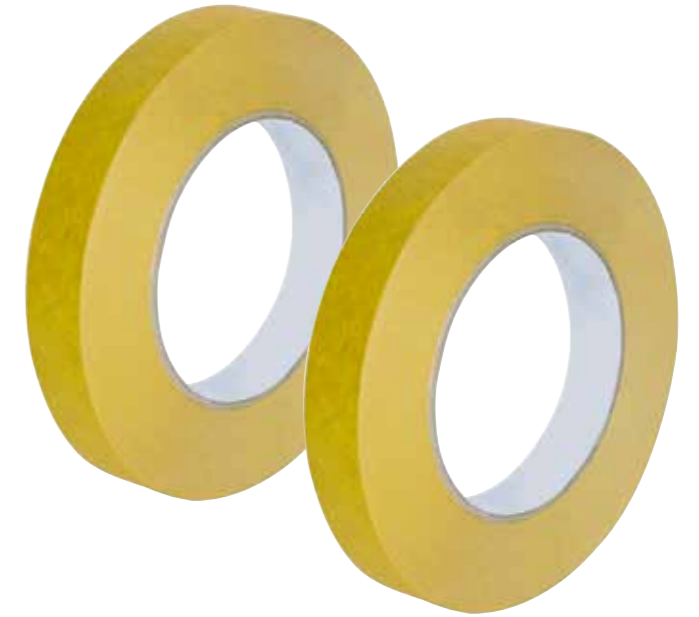

03

**Contour tape**

33 meter rolls

- ▶ Item no. 4585-11
- ▶ Quantity per box: 10
  
- ▶ Technical specifications
- ideal for masking curves
- particularly flexible
- temperature resistant up to 70 ° C for 1 hour
- solvent and water resistant
- no raised edges when gluing curves
- Width: 6mm
- Length: 33 m
- Colour blue





01

**Thermal tape 110**

50 m rolls

## ► Technical specifications

- does not leave any adhesive residue on the body
- Ideally suited for wet sanding work
- The adhesive force works immediately
- resistant to solvents

- Heat resistance

120°C &gt; 30 minutes

100°C &gt; 1 hour



Item No.	Width (mm)	Length [m]	PU	Quantity per box
4993-119	18	50	1	48
4993-125	24	50	1	36
4993-130	30	50	1	32
4993-138	36	50	1	24
4993-150	48	50	1	20

02

**Thermal tape 80**

50 m rolls

## ► Technical specifications

- does not leave any adhesive residue on the body
- Ideally suited for wet sanding work
- The adhesive force works immediately
- resistant to solvents

- Heat resistance

100°C &gt; 30 minutes

80°C &gt; 1 hour



Item No.	Width (mm)	Length [m]	PU	Quantity per box
4993-519	19	50	1	48
4993-525	25	50	1	36
4993-530	30	50	1	32
4993-538	38	50	1	24
4993-550	50	50	1	24

03

**duct tape**

50 meter rolls

## ► Technical specifications

- solvent-free
- high tack
- Wet grinding strength
- very good paint and filling adhesion
- The masking tape can be easily removed even after it has dried in the oven
- Backing material: lightly creped paper
- Adhesive: natural rubber
- Bond strength on steel: 4.7 N / cm
- Elongation at break: 13%
- Tear force: 53 N / cm
- Temperature resistance: 140 ° C
- Thickness: 170 µm
- Length: 50 m
- Width: 19mm



Item No.	Width (mm)	Length [m]	PU
4992-919	19	50	6
4992-950	50	50	6

04

**Stegoband - lift belt**

Rolls each 10 m

## ► Technical specifications

- self-adhesive
- for body joints
- for covering work on the rubber seals of the panes
- to close the joints between the body parts



Item No.	Width (mm)	Length [m]	PU
4682-009	9	10	1
4682-018	18	10	1
4682-025	25	10	1

01

**Anti-dust cloths**

45 x 75 cm

- ▶ Item no. 2893-165
- ▶ PU: 5

## ▶ Technical specifications

- Carrier material: dense cellulose gauze (viscose)
- Impregnation: non-drying special synthetic resin
- Thread count: 12/7
- Size: 80cm x 50cm
- Proven for decades in paint shops in Europe



02

**Anti-dust cloths especially for water-based paints**

38 x 43 cm

- ▶ Item no. 2893-166
- ▶ PU: 12

## ▶ Technical specifications

- Removal of dust and fibers before applying basic materials (primer, filler)
- Removal of the finest particles before applying any topcoat system
- Cleaning plastic parts
- Size: 380mm x 430mm
- Scope of delivery: 12 wipes / bag



03

**Quick filter sieves**

Item No.	Model	PU
2893-161	125 µm ultra fine	100
2893-163	190 µm ultra fine	100
2893-162	280 µm fine	100

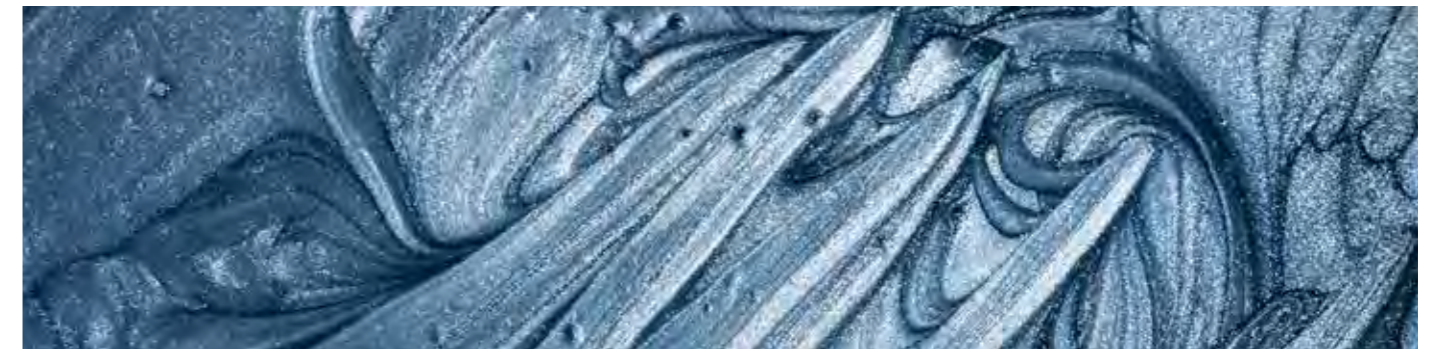
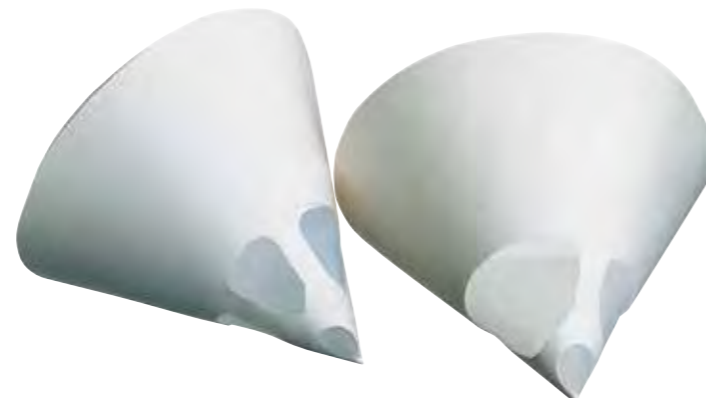

04

**Paint / lacquer mixing cup**

\*\*\*???\* AGWBL Subheadline:1

## ▶ Technical specifications

- very easy pouring
- printed with mixing ratios
- antistatic
- Mixing ratio 1: 1
- Mixing ratio 6: 1
- US ounces liquid scale

Item No.	execution	PU
2891-603	350 ml, cup	300
2891-603-9	Cover for 350 ml cup	50
2891-607	700 ml, cup	300
2891-607-9	Cover for 700 ml cup	50
2891-614	1400 ml, cup	300
2891-614-9	Cover for 1400 ml cup	50
2891-623-0	2,300 ml cup	300
2891-623-9	Cover for 2000 ml cup	100
2891-600	Cup 6000 ml	40
2891-600-9	Lid for 6000 ml beaker	40



05

**Plastic stir bars**

for lacquer mixing cups

- ▶ Item no. 2891-601
- ▶ PU: 200

## ▶ Technical specifications

- made of synthetic recycled material
- easier stirring and better mixing thanks to the S-shape and holes
- for mixing cups with 1400 or 2300 ml
- Dimensions: 30 x 3 cm
- 200 pieces in a dispenser box





01

**Rim silver**

Silver star

- ▶ Item no. 2893-883
- ▶ colour: silver
- ▶ Content: 400 ml
- ▶ Quantity per box: 24

## ▶ Technical specifications

- high hiding power
- abrasion resistant
- car wash resistant
- resistant to road salt, stone chips etc.
- Heavy metals free: no lead, cadmium, chromium



02

**Heat-resistant paint spray**

corona

- ▶ Item no. 2893-887
- ▶ colour: silver
- ▶ Content: 400 ml
- ▶ Quantity per box: 6

## ▶ Technical specifications

- heat-resistant up to 650 ° C



03

**Heat-resistant paint spray**

corona

- ▶ Item no. 2893-886
- ▶ colour: matte black
- ▶ Content: 400 ml
- ▶ Quantity per box: 6

## ▶ Technical specifications

- heat-resistant up to 650 ° C



04

**Paint spray matt**

Kroma

- ▶ Item no. 2893-884
- ▶ colour: matte black
- ▶ Content: 400 ml
- ▶ Quantity per box: 24

## ▶ Technical specifications

- very high opacity
- lightfast
- high solid content
- scratch resistant



01

**Clear coat**

- ▶ Item no. 2893-803
- ▶ colour: transparent high gloss
- ▶ Content: 400 ml
- ▶ Quantity per box: 24
- ▶ Technical specifications
  - weatherproof
  - fast drying
  - high solids content
  - scratch-resistant
  - easy processing
  - good course
  - protects new sheets from rusting
  - weldable
  - Abrasion-resistant after drying
  - high corrosion protection
  - high proportion of active ingredients



02

**2K clear coat**

- ▶ Item no. 2800-770
- ▶ Content: 400 ml
- ▶ Quantity per box: 6
- ▶ Technical specifications
  - extremely UV-resistant
  - brilliant gloss level
  - permanently petrol, diesel, acid and oil resistant
  - constant pressure up to the last second of the contents of the can
  - very little overspray
  - makes the surface very scratch-resistant and resistant to environmental influences
  - excellent filling capacity



03

**Fade-in paint**

- ▶ Item no. 2800-780
- ▶ Content: 400 ml
- ▶ Quantity per box: 6
- ▶ Technical specifications
  - for touching up paint transitions with blending



04

**Pistol grip**  
for spray cans

- ▶ Item no. 2893-900-2
- ▶ PU: 1



05

**Fan nozzle**  
for spray cans

- ▶ Item no. 2893-900-3
- ▶ PU: 12



06

**Sealing cap**  
for used aerosol cans

- ▶ Item no. 2897-999
- ▶ PU: 10



07

**spray nozzle**  
for Super-Crack and Arctic

- ▶ Item no. 2894-449-999
- ▶ PU: 1







**Spray paint**

- extremely weather-resistant
- fast drying
- very high opacity
- high solids content
- scratch-resistant
- Heavy metals free: no lead, cadmium, chromium



**RAL 3000 fire red silk glossy**

- ▶ Item no. 2893-810-001
- ▶ Content: 400 ml
- ▶ Quantity per box: 6
- ▶ for example for:
  - Agricultural machinery / DAF
  - RAL 3000 = IC-096 / MB3524



**RAL 3002 Crimson red**

- ▶ Item no. 2893-810-007
- ▶ Content: 400 ml
- ▶ Quantity per box: 6
- ▶ for example for:
  - MAN driver's cab /
  - Iveco / DAF
  - RAL 3002 = Iveco IC 186 / MB 3535



**\*\*\*???\* ATWBL Headline:2**

- ▶ Item no. 2893-870-005
- ▶ Content: 400 ml
- ▶ Quantity per box: 6
- ▶ for example for:
  - Fork-lift truck

**RAL 2011 Deep orange**

- ▶ Item no. 2893-850-006
- ▶ Content: 400 ml
- ▶ Quantity per box: 6
- ▶ for example for:
  - Mercedes Benz
  - Municipal vehicles
  - Construction machinery
  - RAL 2011 = MB2603



**RAL 5002 ultramarine blue**

- ▶ Item no. 2893-870-004
- ▶ Content: 400 ml
- ▶ Quantity per box: 6
- ▶ for example for:
  - THW (Technisches Hilfswerk, Federal Agency for Technical Relief)
  - MAN chassis
  - DAF



**RAL 5010 ultramarine blue**

- ▶ Item no. 2893-810-009
- ▶ Content: 400 ml
- ▶ Quantity per box: 6
- ▶ for example for:
  - Mercedes Benz / Unimog
  - THW vehicles / containers
  - MAN driver's cab
  - German Railways / diggers
  - RAL 5010 = Iveco IC-071 / MB 5361

## Spray paint

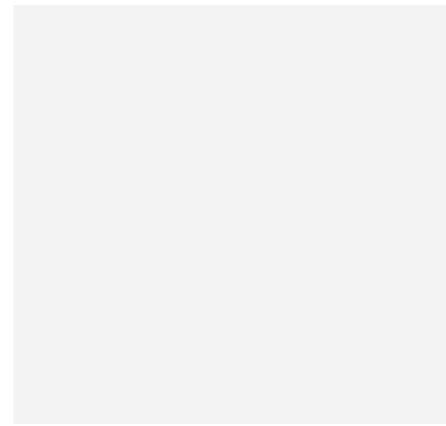
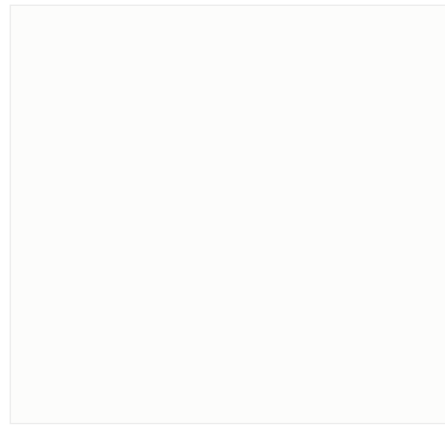
**RAL 9010 Pure white**

- ▶ Item no. 2893-810-006
- ▶ Content: 400 ml
- ▶ Quantity per box: 6

## ▶ for example for:

- Mercedes Benz / Iveco / Scania
- Tractors / Agricultural machinery
- MB box body
- MAN driver's cab
- RAL 9010 = Iveco IC-082

**MB 9147 arctic white**

- ▶ Item no. 2893-830-008
- ▶ Content: 400 ml
- ▶ Quantity per box: 6

## ▶ for example for:

- Mercedes Benz

**MB 7354 argentite grey**

- ▶ Item no. 2893-830-003
- ▶ Content: 400 ml
- ▶ Quantity per box: 6

## ▶ for example for:

- Mercedes Benz

**DB 7350 novagrey**

- ▶ Item no. 2893-830-009
- ▶ Content: 400 ml
- ▶ Quantity per box: 6

## ▶ for example for:

- Mercedes Benz
- DB 7350 = MB 7350

**RAL 9006 white aluminium**

- ▶ Item no. 2893-820-005
- ▶ Content: 400 ml
- ▶ Quantity per box: 6

## ▶ for example for:

- Aluminium superstructures
- Aluminium rims
- German Railways
- Agricultural machinery / chassis

**RAL 9007 grey aluminium**

- ▶ Item no. 2893-870-001
- ▶ Content: 400 ml
- ▶ Quantity per box: 6

## ▶ for example for:

- Construction machinery

**RAL 7024 graphite grey**

- ▶ Item no. 2893-870-006
- ▶ Content: 400 ml
- ▶ Quantity per box: 6

## ▶ for example for:

- Mercedes Benz

**RAL 7021 black grey**

- ▶ Item no. 2893-870-003
- ▶ Content: 400 ml
- ▶ Quantity per box: 6

## ▶ for example for:

- German army construction machinery





### RAL 9011 graphite black

- ▶ Item no. 2893-860-002
- ▶ Content: 400 ml
- ▶ Quantity per box: 6
- ▶ for example for:
  - MAN standard chassis colour
  - Tractors / agricultural machinery



### RAL 9005 black glossy

- ▶ Item no. 2893-885
- ▶ Content: 400 ml
- ▶ Quantity per box: 24
- ▶ for example for:
  - universally usable

## Spray paint

01

### Silicone remover colorless

- ▶ Item no. 2800-720
- ▶ Content: 400 ml
- ▶ Quantity per box: 6

#### ▶ Technical specifications

- suitable for all cleaning work before and during painting, e.g. tar splashes, diesel soot, etc.



### RAL 9005 deep black high gloss

- ▶ Item no. 2893-810-008
- ▶ Content: 400 ml
- ▶ Quantity per box: 6
- ▶ for example for:
  - Mercedes Benz / Iveco
  - MAN chassis / German army
  - RAL 9005 = Iveco IC-248 / MB 9040

02

### Anti-dust cloths

- ▶ Item no. 2893-165
- ▶ PU: 5

#### ▶ Technical specifications

- Carrier material: dense cellulose gauze (viscose)
- Impregnation: non-drying special synthetic resin
- Thread count: 12/7
- Size: 80cm x 50cm
- Proven for decades in paint shops in Europe



03

### Anti-dust cloths especially for water-based paints

- ▶ Item no. 2893-166
- ▶ PU: 12

#### ▶ Technical specifications

- Removal of dust and fibers before applying basic materials (primer, filler)
- Removal of the finest particles before applying any topcoat system
- Cleaning plastic parts
- Size: 380mm x 430mm
- Scope of delivery: 12 wipes / bag



01

**Highly active cleaner, degreaser and control spray**

Surface Control

- ▶ Item no. 2000-28-185
- ▶ Content: Surface Control
- ▶ Quantity per box: 6
  
- ▶ Item no. 2000-28-5
- ▶ Content: Uni-Star
- ▶ PU: 1
  
- ▶ Technical specifications
  - effective and very effective cleaner in a refillable dosing pump bottle
  - excellent degreasing properties
  - Effectively removes all conventional polishing and silicone residues
  - Paint shops friendly
  - powerful degreasing without affecting the existing paint film / surface
  - Compatible with all paint systems including the water-based
  - For use, we recommend the very soft, turquoise microfiber cloth 40x40cm (item no. : 2000-940-40) or the purple microfiber cloth 40x60cm (item no.2000-940-60)

**Pouring tap**

for 5 liter containers

- ▶ Item no. 2000-000-005
- ▶ PU: 1



02

**Microfiber cloth**

Very soft

- ▶ Item no. 2000-940-40
- ▶ PU: 2
  
- ▶ Technical specifications
  - very soft
  - high quality
  - lint-free cleaning
  - Washable up to max. 60 ° C
  - not suitable for the dryer
  - Dimensions: 40x40cm
  - 2 pieces per package



03

**Microfiber cloth**

for lint-free cleaning

- ▶ Item no. 2000-940-60
- ▶ PU: 2
  
- ▶ Technical specifications
  - high quality
  - lint-free cleaning
  - Washable up to max. 60 ° C
  - purple
  - not suitable for the dryer
  - Dimensions: 40x60cm
  - 2 pieces per package





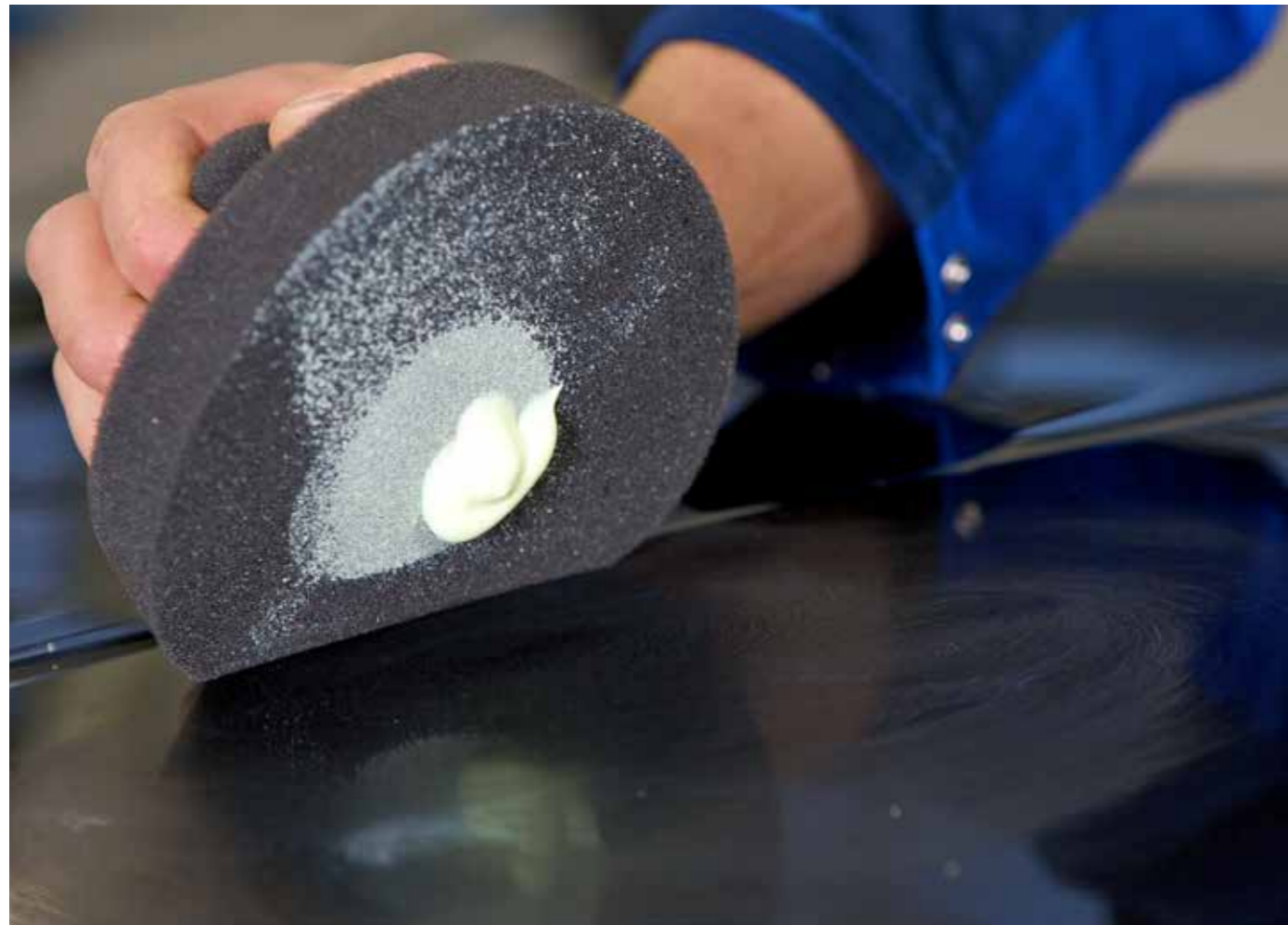

01

### Grinding-polishing-sealing Compact

- ▶ Item no. 2000-335-1
- ▶ Content: 1 kg
- ▶ Quantity per box: 6

#### ▶ Technical specifications

- fast and professional preparation of used vehicle paints
- Grinding, polishing and sealing in one step
- free of volatile silicones
- suitable for HS lacquers



02

### Polishing sponge medium medium removal, orange

Item No.	Ø mm	PU
2000-352-75	75	4
2000-352-150	150	2



03

### Polishing sponge soft slight removal, black

Item No.	Ø mm	PU
2000-353-75	75	4
2000-353-150	150	2



04

### Waffle polishing sponge for very easy removal, black

Item No.	Ø mm	PU
2000-354-75	75	4
2000-354-150	150	2



05

### Application sponge Application sponge for hand processing

Item No.	Ø mm	PU
2000-209-130	130	1







**01**  
**High gloss polish**  
Perfect gloss

- ▶ Item no. 2000-344-1
- ▶ Content: 1 litre
- ▶ Quantity per box: 6
  
- ▶ Item no. 2000-344-5
- ▶ Content: 5 litres
- ▶ PU: 1
  
- ▶ Technical specifications
- removes holograms
- leaves a long-lasting deep shine and protection
- does not contain any volatile silicone
- Processing by hand possible
- Rotary machines: 800 - 1,500 rpm
- Eccentric machines: 1,700 - 2,200 rpm



**Pouring tap**  
for 5 liter containers

- ▶ Item no. 2000-000-005
- ▶ PU: 1



**Push-pull closure**  
for 500ml and 1000ml bottles

- ▶ Item no. 2000-356-2
- ▶ PU: 1



**02**  
**Waffle polishing sponge**  
for very easy removal, black

Item No.	Ø mm	PU
2000-354-75	75	4
2000-354-150	150	2



**03**  
**Polishing sponge soft**  
slight removal, black

Item No.	Ø mm	PU
2000-353-75	75	4
2000-353-150	150	2



**04**  
**Application sponge**  
Application sponge for hand processing

Item No.	Ø mm	PU
2000-209-130	130	1





**High-performance grinding paste**

\*\*\*????\*\* ATWBL Subheadline:1

- ▶ Item no. 2000-341-500
- ▶ Content: 500 g
- ▶ Quantity per box: 6

▶ **Product description**

- Polishing paste for the 1st step of our 2-step polishing system
- extremely quickly and perfectly to the desired reprocessing goal
- extremely high removal rate with DRA technology
- high gloss level
- silicone and ammonia free
- free from gloss enhancers
- long processing time
- is suitable for all automotive

**High gloss anti-hologram polish**

Scratch Finish

- ▶ Item no. 2000-343-500
- ▶ Content: 500 g
- ▶ Quantity per box: 6

▶ **Product description**

- Polish for the 2nd step of our 2-step polishing system
- ultra fine abrasive with DRA technology
- silicone and wax free
- suitable for all automotive paint systems including cellulose, 1K



matching:  
Microfiber cloth  
Item No. 2000-740-40



matching:  
Microfiber cloth  
Item No. 2000-745-40



matching:  
Microfiber cloth  
Item No. 2000-940-60



01  
**Lambskin**  
Color white

Item No.	Ø mm	PU
2000-350-75	75	4
2000-350-150	150	2



02  
**Polishing sponge medihard**  
for scratch cut

Item No.	Ø mm	PU
2000-357-80	80	4
2000-357-150	150	2



03  
**Polishing sponge medium**  
medium removal, orange

Item No.	Ø mm	PU
2000-352-75	75	4
2000-352-150	150	2



04  
**Waffle polishing sponge**  
for very easy removal, black

Item No.	Ø mm	PU
2000-354-75	75	4
2000-354-150	150	2



01

**Quick seal**  
Speed Gloss Nano

- ▶ Item no. 2000-316-1
- ▶ Content: 1 litre
- ▶ Quantity per box: 6
  
- ▶ Item no. 2000-316-5
- ▶ Content: 5 litres
- ▶ PU: 1
  
- ▶ Technical specifications
- perfect gloss effect
- effortless, residue-free repolishing
- suitable for cleaning without water
- contains carnauba wax



**Pouring tap**  
for 5 liter containers

- ▶ Item no. 2000-000-005
- ▶ PU: 1



**Push-pull closure**  
for 500ml and 1000ml bottles

- ▶ Item no. 2000-356-2
- ▶ PU: 1



02

**Microfiber cloth**  
Gray

- ▶ Item no. 2000-745-40
- ▶ PU: 1
  
- ▶ Technical specifications
- extremely soft plush cloth
- Scratch-free polishing of polish residues
- Wash up to 40 ° C
- Tumble dry up to 30 ° C
- do not use plasticizers and bleach



03

**Microfiber cloth**  
medium high pile

- ▶ Item no. 2000-840-60
- ▶ PU: 1
  
- ▶ Technical specifications
- Dimensions: 40 x 60 cm
- medium deep pile
- very soft
- high quality
- washable up to 40 ° C
- not suitable for the dryer
- Do not use any softeners or bleach when washing!



04

**Application sponge**  
black

- ▶ Item no. 2000-209-130
- ▶ PU: 1
  
- ▶ Technical specifications
- ergonomic handle for easy and safe processing of:
- Wax sealer Speed-Wax (Item number 2000-330-1)
- Quick sealer Speed Gloss Nano (Art.-No. 2000-316)



05

**Long-term surface protection sealing**  
Pearl

- ▶ Item no. 2897-327
- ▶ Content: 500 ml
- ▶ Quantity per box: 12
  
- ▶ Item no. 2897-327-5
- ▶ Content: 5 litres
- ▶ PU: 1
  
- ▶ Technical specifications
- Surface protection sealing



**Pouring tap**  
for 5 liter containers

- ▶ Item no. 2000-000-005
- ▶ PU: 1

06

**Microfiber cloth**  
Gray

- ▶ Item no. 2000-745-40
- ▶ PU: 1
  
- ▶ Technical specifications
- extremely soft plush cloth
- Scratch-free polishing of polish residues
- Wash up to 40 ° C
- Tumble dry up to 30 ° C
- do not use plasticizers and bleach



07

**Microfiber cloth**  
medium high pile

- ▶ Item no. 2000-840-60
- ▶ PU: 1
  
- ▶ Technical specifications
- Dimensions: 40 x 60 cm
- medium deep pile
- very soft
- high quality
- washable up to 40 ° C
- not suitable for the dryer
- Do not use any softeners or bleach when washing!





01

**Carnauba wax sealant Premium Wax**

Premium Wax

- ▶ Item no. 2000-330-200
- ▶ Content: 200 ml
- ▶ Quantity per box: 12

▶ **Technical specifications**

- long-lasting sealing
- with maximum, high-purity Brazilian carnauba wax content
- can be processed excellently
- leaves a brilliant mirror shine with a lotus effect
- Processing can either be done with the hand application sponge (item no. 2000-209-130) or the waffle sponge (item no. 2000-354- ..) in conjunction with the eccentric polishing machine (item no. 8697-114 -13) at a speed of approx. 1700-2200 rpm
- maximum carnauba wax content (more than 40g carnauba on 200g wax)
- high-quality oils and natural raw materials support the protective and shine effect
- simple, effortless manual processing
- Top class car care wax produced by hand in small series



02

**Microfiber cloth**

Gray

- ▶ Item no. 2000-745-40
- ▶ PU: 1

▶ **Technical specifications**

- extremely soft plush cloth
- Scratch-free polishing of polish residues
- Wash up to 40 ° C
- Tumble dry up to 30 ° C
- do not use plasticizers and bleach



03

**Microfiber cloth**

medium high pile

- ▶ Item no. 2000-840-60
- ▶ PU: 1

▶ **Technical specifications**

- Dimensions: 40 x 60 cm
- medium deep pile
- very soft
- high quality
- washable up to 40 ° C
- not suitable for the dryer
- Do not use any softeners or bleach when washing!



04

**Waffle polishing sponge**

for very easy removal, black

Item No.	Ø mm	PU
2000-354-75	75	4
2000-354-150	150	2



05

**Polishing sponge soft**

slight removal, black

Item No.	Ø mm	PU
2000-353-75	75	4
2000-353-150	150	2



06

**Application sponge**

Application sponge for hand processing

Item No.	Ø mm	PU
2000-209-130	130	1



01

**Long-term sealing**

Paint Guard

- ▶ Item no. 2000-331-500
- ▶ Content: 500 ml
- ▶ Quantity per box: 12

▶ **Technical specifications**

- Processing by hand
- extra UV protection for long-term preservation of the paint layer
- leaves a deep shine
- free of volatile silicones

**Push-pull closure**

for 500ml and 1000ml bottles

- ▶ Item no. 2000-356-2
- ▶ PU: 1



02

**Microfiber cloth**

Gray

- ▶ Item no. 2000-745-40
- ▶ PU: 1

▶ **Technical specifications**

- extremely soft plush cloth
- Scratch-free polishing of polish residues
- Wash up to 40 ° C
- Tumble dry up to 30 ° C
- do not use plasticizers and bleach



03

**Microfiber cloth**

medium high pile

- ▶ Item no. 2000-840-60
- ▶ PU: 1

▶ **Technical specifications**

- Dimensions: 40 x 60 cm
- medium deep pile
- very soft
- high quality
- washable up to 40 ° C
- not suitable for the dryer
- Do not use any softeners or bleach when washing!



04

**Application sponge**

black

- ▶ Item no. 2000-209-130
- ▶ PU: 1

▶ **Technical specifications**

- ergonomic handle for easy and safe processing of:
- Wax sealer Speed-Wax (Item number 2000-330-1)
- Quick sealer Speed Gloss Nano (Art.-No. 2000-316)



05

**Ceramic sealant Ceramic Shield 9H Set**

Ceramic Shield 9H Set

- ▶ Item no. 2000-333

▶ **Technical specifications**

- Ultimate sealing
- 9H protective layer for the paint
- Long-term protection up to 3 years
- hydrophobic and dirt-repellent
- increased service life of the paint
- 
- Content:
  - 30ml ceramic-quartz long-term sealing
  - 185ml Surface Control - highly active cleaner, degreaser and control spray (item no.2000-28-185)
  - 1x pipette
  - 1x application block
  - 3x dust cloth, light blue 30x38cm
  - 2x silk scarf 12x12cm
  - 2x microfiber cloth, turquoise 40x40cm (Item No. 2000-940-40)
  - 1 pair of disposable gloves
  - Instructions for use

matching:  
Microfiber cloth  
Item No. 2000-940-60





01

**Matting paste**

Scraper

- ▶ Item no. 2000-314-1
- ▶ Content: 1 litre
- ▶ PU: 1

▶ **Technical specifications**

- Surface preparation for areas to be painted
- specially designed for use with abrasive fleece
- ensures an increase in grinding power



02

**Microfiber cloth**

standard

- ▶ Item no. 2000-640-40
- ▶ PU: 2

▶ **Technical specifications**

- Dimensions: 40 x 40 cm
- lint and dust free
- washable up to 40 °C
- tumble dryer suitable up to 30 °C



03

**Microfiber cloth**

medium high pile

- ▶ Item no. 2000-840-60
- ▶ PU: 1

▶ **Technical specifications**

- Dimensions: 40 x 60 cm
- medium deep pile
- very soft
- high quality
- washable up to 40 °C
- not suitable for the dryer
- Do not use any softeners or bleach when washing!



04

**Abrasive fleece**

very fine, red

▶ **Technical specifications**

- Grain size 360
- High flexibility
- more performance due to innovative spreading
- for wet and dry applications
- Grit type: aluminium oxide very fine
- Binder: synthetic resin
- Carrier material: non-woven
- Scattering: total coating, three-dimensional
- Colour: red



Item No.	execution	Grit	PU
4585-451-10	Roll 115 mm x 10 m	360	1
4585-451	Pads 152 mm x 229 mm	360	20

05

**Abrasive fleece**

ultra fine, gray

▶ **Technical specifications**

- Grit 1,500
- high flexibility
- more performance through innovative distribution
- for wet and dry applications
- also for animal hair
- Grain type: aluminum oxide ultra fine
- Binder: synthetic resin
- Backing material: fleece
- Scattering: Total Coating, three-dimensional
- Color gray



Item No.	execution	Grit	PU
4585-455-10	Roll 115 mm x 10 m	1500	1
4585-455	Pads 152 mm x 229 mm	1500	20

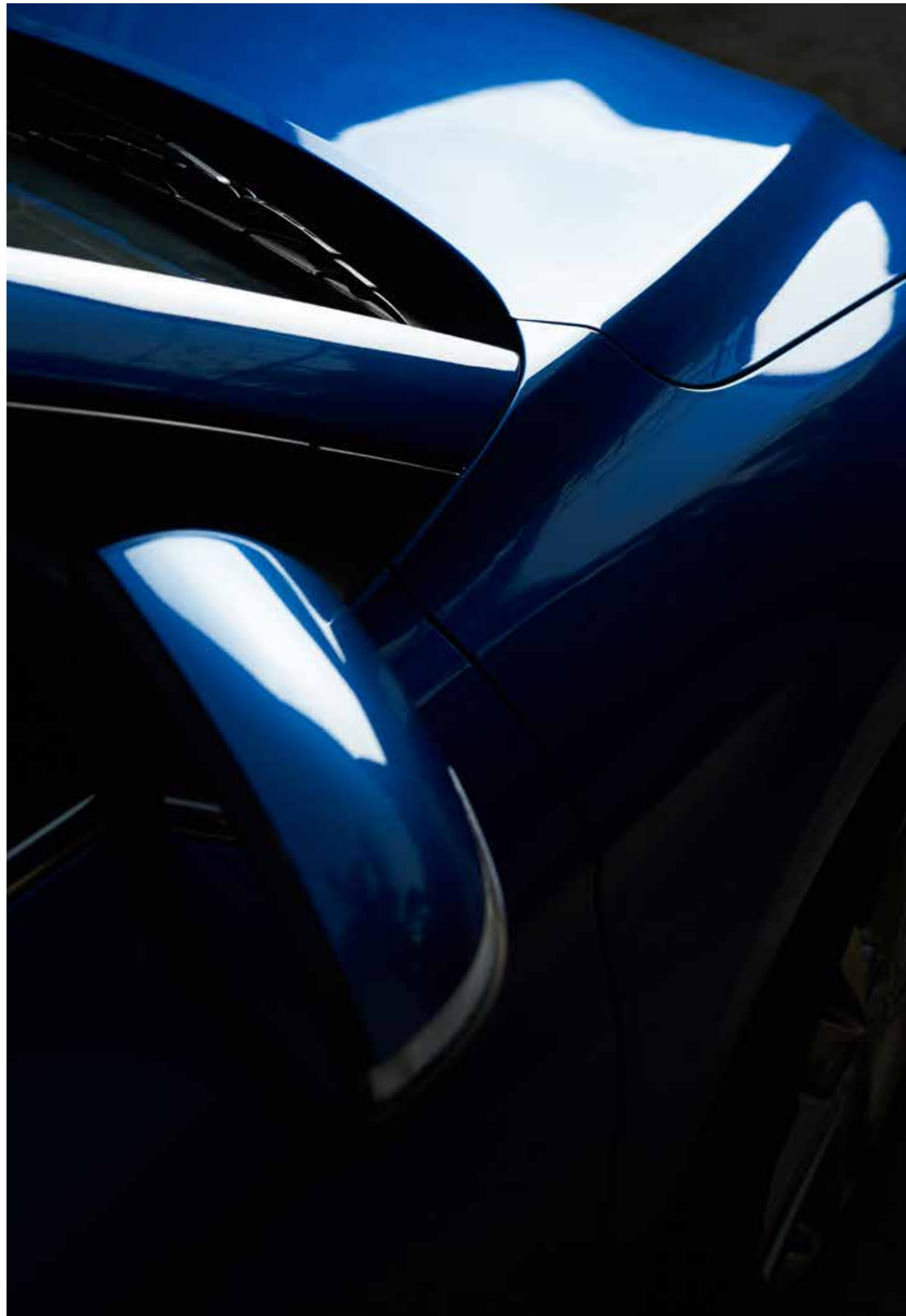

01

**Mini polishing machine**  
incl. Velcro plate

► Item no. 8696-540-004

► Technical specifications

- Weight: 600 g
- Max. Speed: 5,500 rpm
- Adjustable speed: yes
- Vibrations: <math><2.5 \text{ m / s}^2</math>
- Air consumption: 84 l / min
- Sound power level: 89.4 dB
- Length: 130 mm
- Velcro plate diameter: approx. 75mm
- incl. plug nipple with 1/4 „male thread



02

**Velcro plate**

Replacement plate for mini polishing machine

Item No.	Ø mm
8696-540-050	50
8696-540-075	75





01

**3in1 Velcro polishing pad**

has an M14 thread mount

▶ Item no. 4666-075-150

▶ Technical specifications

- consists of three different sized Velcro plates: 75mm, 120mm and 145 mm
- No need to re-clamp Velcro discs in different sizes
- suitable for all of our polishing sponges and lambskins
- offers a high degree of flexibility
- has an M14 machine mount



02

**Velcro plate**

for polishing machine

▶ Technical specifications

- with Velcro attachment for polishing sponges
- M14 thread mount

Item No.	Ø
4666-075-1	75 mm
4666-150-1	150 mm



03

**Eccentric polishing machine**

Tornador Ø 150 mm

▶ Item no. 8697-114-13

▶ Technical specifications

- max. polishing pad Ø: 180 mm
- max. support pad Ø: 150 mm
- Speeds: 1700-4200 rpm
- Eccentric stroke: 21 mm
- Power output: 900W
- 10 meters of cable
- stepless adjustable speed
- removable additional handle 240V / 50Hz
- Weight: 4.28 kg



04

**Velcro plate**

for eccentric polishing machine

▶ Item no. 8697-114-132

▶ Technical specifications

- Ø 150 mm



01

**Spider polishing sponge**

Color: blue with excenter

Item No.	Ø mm	PU
2000-355-150	150	2



02

**Polishing sponge medium**

medium removal, orange

Item No.	Ø mm	PU
2000-352-75	75	4
2000-352-150	150	2



03

**Polishing sponge medihard**

for scratch cut

Item No.	Ø mm	PU
2000-357-80	80	4
2000-357-150	150	2



04

**Polishing sponge hard**

high stock removal, yellow

Item No.	Ø mm	PU
2000-351-75	75	4
2000-351-150	150	2



05

**Lambskin**

Color white

Item No.	Ø mm	PU
2000-350-75	75	4
2000-350-150	150	2



06

**Polishing sponge soft**

slight removal, black

Item No.	Ø mm	PU
2000-353-75	75	4
2000-353-150	150	2



07

**Waffle polishing sponge**

for very easy removal, black

Item No.	Ø mm	PU
2000-354-75	75	4
2000-354-150	150	2



08

**Application sponge**

Application sponge for hand processing

Item No.	Ø mm	PU
2000-209-130	130	1





01

**Microfiber cloth**

seamless

- ▶ Item no. 2000-740-40
- ▶ PU: 1

## ▶ Technical specifications

- Dimensions: 40 x 40 cm
- deep pile
- rounded edges
- washable up to 40 ° C
- Suitable for tumble dryers up to 30 ° C
- Do not use any softeners or bleach when washing!

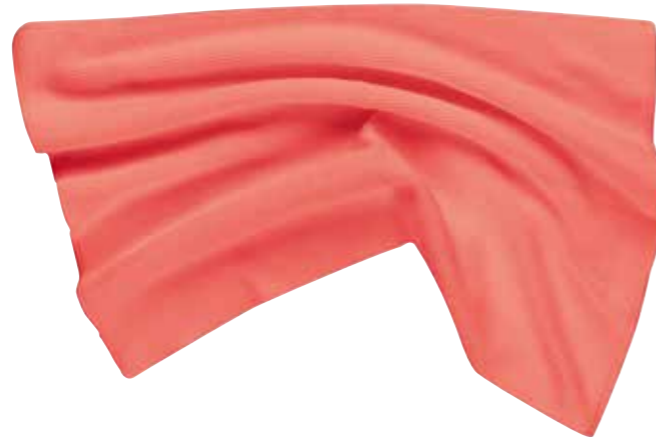

02

**Microfiber cloth**

standard

- ▶ Item no. 2000-640-40
- ▶ PU: 2

## ▶ Technical specifications

- Dimensions: 40 x 40 cm
- lint and dust free
- washable up to 40 ° C
- tumble dryer suitable up to 30 ° C



03

**Microfiber cloth**

Very soft

- ▶ Item no. 2000-940-40
- ▶ PU: 2

## ▶ Technical specifications

- very soft
- high quality
- lint-free cleaning
- Washable up to max. 60 ° C
- not suitable for the dryer
- Dimensions: 40x40cm
- 2 pieces per package



04

**Microfiber cloth**

for lint-free cleaning

- ▶ Item no. 2000-940-60
- ▶ PU: 2

## ▶ Technical specifications

- high quality
- lint-free cleaning
- Washable up to max. 60 ° C
- purple
- not suitable for the dryer
- Dimensions: 40x60cm
- 2 pieces per package



05

**Microfiber cloth**

Gray

- ▶ Item no. 2000-745-40
- ▶ PU: 1

## ▶ Technical specifications

- extremely soft plush cloth
- Scratch-free polishing of polish residues
- Wash up to 40 ° C
- Tumble dry up to 30 ° C
- do not use plasticizers and bleach



06

**Microfiber cloth**

medium high pile

- ▶ Item no. 2000-840-60
- ▶ PU: 1

## ▶ Technical specifications

- Dimensions: 40 x 60 cm
- medium deep pile
- very soft
- high quality
- washable up to 40 ° C
- not suitable for the dryer
- Do not use any softeners or bleach when washing!





01

**protective suit**

One-way

► **Technical specifications**

- Particle-tight according to EN 13982-1
- limited splash-tight according to EN 13034
- Zipper cover
- Arm, leg and waist elastic
- three-part hood with elastic for optimal adjustment
- Material: 3-layer SMS
- Color white
- individually packed in a bag
- 50 pieces in a box
- Category III EN ISO 13982-1 Type 5 EN 13034 Type 6

Item No.	size	PU
4899-500-7	52/54 L	1
4899-500-8	56/58 XL	1
4899-500-9	60/62 XXL	1



02

**Painting masks set**

3M™

► **Item no. 7200-002-10**► **PU: 1**► **Technical specifications**

- low-maintenance, easy to use and particularly lightweight
- economical and easy to care for
- for all painting, mixing of colors and the use of adhesives
- Head harness straps and easy-to-attach neck strap
- light elastomer material for more comfort during long periods of use
- Double filter system for reduced breathing resistance and good weight distribution
- wide range of filters for a wide range of applications
- Bayonet click system for connection to various filters for protection against gases, vapors and particles
- Set in airtight, resealable box

- Contents of the set:

- 1 x half mask
- 2 x gas and combination filters A2
- 4 x particle filter
- 2 x filter covers
- 10 x cleaning wipes



03

**Respirator**

FFP2

► **Item no. 0899-5**► **PU: 20**► **Technical specifications**

- high filtration efficiency
- low breathing resistance
- individually welded
- 2 pieces in a cardboard box
- 20 in a packaging unit
- especially skin-friendly
- Protection class FFP2
- Size: 110 x 160 mm
- 4 layer filter system
- Weight: 7g per mask
- foldable and soft material
- non medical: EN149: 2001 A1: 2009
- CE mark 2797







Vehicle parts passenger cars



## 01

**Hose clamps with worm thread**► **Technical specifications**

- Strap and case: stainless steel 1.4016
- Screw: steel, galvanized, band width 9 mm
- Wrench size 7 mm



Item No.	Clamping range	PU
5539-008-12	8 - 12 mm	50
5539-008-16	8 - 16 mm	50
5539-012-20	12 - 20 mm	50
5539-016-25	16 - 25 mm	50
5539-020-32	20 - 32 mm	50
5539-025-40	25 - 40 mm	50
5539-032-50	32 - 50 mm	50
5539-040-60	40 - 60 mm	25
5539-050-70	50 - 70 mm	25
5539-060-80	60 - 80 mm	25
5539-070-90	70 - 90 mm	25
5539-080-100	80 - 100 mm	25
5539-090-110	90 - 110 mm	25
5539-100-120	100 - 120 mm	25
5539-110-130	110 - 130 mm	25
5539-120-140	120 - 140 mm	25
5539-130-150	130 - 150 mm	10
5539-140-160	140 - 160 mm	10
5539-150-170	150 - 170 mm	10
5539-160-180	160 - 180 mm	10

## 02

**Hose clamp display**► **Item no. 5539-077-777**► **Technical specifications**

- Band width 9 mm
- embossed band inside
- Band and housing made of stainless steel 1.4016
- Corrosion resistance in the salt spray test at least 72 hours
- Trapezoidal thread (smooth inside of the belt)
- Screw with cross recess (SW 7), galvanized steel

- **Applications:**

- Cooling water connections
- Pressureless and pressurized fuel lines and vents
- Oil lines
- Connections of pipes in the sanitary area
- Connections of lines in mechanical engineering
- Lines in the household appliance industry
- Hose connections in the commercial vehicle industry

- 
- 20 x hose clamps with worm thread 8-16 (item no. 5539-008-16)
- 20 x hose clamps with worm thread 12-22 (item no. 5539-012-20)
- 10 x hose clamps with worm thread 16-27 (item no. 5539-016-25)
- 10 x hose clamps with worm thread 20-32 (item no. 5539-020-32)
- 10 x hose clamps with worm thread 25-40 (item no. 5539-025-40)
- 10 x hose clamps with worm thread 32-50 (item no. 5539-032-50)
- 10 x hose clamps with 40-60 worm thread (item no. 5539-040-60)
- 10 x hose clamps with worm thread 50-70 (item no. 5539-050-70)
- 10 x hose clamps with worm thread 60-80 (item no. 5539-060-80)
- 10 x hose clamps with worm thread 70-90 (item no. 5539-070-90)
- 1 x 426-7; hexagonal socket wrench (item no. 5539-85)
- 1 x perforated plate 500x450 MM (Item No. 7100-000-1)
- 12 x tool holder angled 150mm (Item No. 7100-000-3)
- 1 x tool clamp small 19mm (Item No. 7100-000-305)
- 2 x self-adhesive label strips 430mm (Item No. 7100-000-5)





01

**ABA hose clamps**► **Technical specifications**

- 50% greater tensile load compared to standard worm-drive hose clamps
- Weld- and rivet-free casing made from one piece
- Embossed band with high edges prevents damage to the hose wall
- Short casing saddle guarantees optimal positive locking
- Hexagon socket screw with slot

Item No.	Clamping range	Bandwidth	PU
5538-008-012	8 - 12 mm	9 mm	50
5538-010-016	10 - 16 mm	9 mm	50
5538-012-020	12 - 20 mm	9 mm	50
5538-016-025	16 - 25 mm	9 mm	50
5538-020-032	20 - 32 mm	9 mm	50
5538-025-040	25 - 40 mm	9 mm	50
5538-032-050	32 - 50 mm	9 mm	50



02

**Hose clamps made of stainless steel with worm thread and wave spring**► **Technical specifications**

- integrated spring insert
- completely made of stainless steel
- Band width 12mm
- embossed band inside
- Drive screw hex. Wrench size 7mm with slot
- compensates for diameter fluctuations
- Automatic retensioning effect when the hose relaxes
- Increased sealing reliability over a wide temperature range
- Material: W4
- Corrosion resistance in the salt spray test: at least 240 hours

Item No.	Clamping range	Bandwidth	PU
5539-216-27	16 - 27 mm	12 mm	25
5539-220-32	20 - 32 mm	12 mm	25
5539-225-40	25 - 40 mm	12 mm	25
5539-230-45	30 - 45 mm	12 mm	25
5539-235-50	35 - 50 mm	12 mm	25
5539-240-60	40 - 60 mm	12 mm	25
5539-250-70	50 - 70 mm	12 mm	25
5539-260-80	60 - 80 mm	12 mm	25



03

**Hose clamps ABA mini**► **Technical specifications**

- for small diameters and thin-walled hoses
- pre-galvanized clamp
- Screw with combination slot
- Use of various installation tools
- rounded edges
- The strap is placed under the hose, profiled for additional tension
- Hexagonal head that can be tightened flexibly
- the nut cannot be lost even if the screw is removed

Item No.	Clamping range	PU
5546-9-7	7-13 mm	50
5546-9-8	8-13 mm	50
5546-9-9	9-13 mm	50
5546-9-10	10-13 mm	50
5546-9-11	11-16 mm	50
5546-9-12	12-16 mm	50
5546-9-13	13-16 mm	50
5546-9-14	14-16 mm	50
5546-9-15	15-20 mm	50
5546-9-16	16-20 mm	50
5546-9-17	17-20 mm	50



04

**Hose clamps Norma**► **Technical specifications**

- Band width 9 mm
- all parts are completely galvanized steel
- Corrosion resistance in the salt spray test at least 72 hours
- with cylinder head screw
- manufactured according to DIN 3017

Item No.	Ø range	Bandwidth	PU
5540-18-9	18 mm	9 mm	50
5540-20-9	20 mm	9 mm	50
5540-22-9	22 mm	9 mm	50
5540-18-12	18 mm	12 mm	50
5540-19-12	19 mm	12 mm	50
5540-25-15	25 mm	15 mm	50



01

**Fuel hose clamps**► **Technical specifications**

- quick, easy and safe assembly
- Good edge rounding through vibratory grinding technology prevents damage to the item to be set
- Setting control through visible reshaping of the clamp ear
- The flanged insert ring bridges the gap in the ear of the clamp ear, thus ensuring all-round binding
- material
- Clamp: stainless steel, material no. 1.4301 / UNS S30400
- Insert ring: stainless steel, material no. 1.4310 / UNS S30100



Item No.	Clamping range	Bandwidth	PU
5541-070	5,6 - 6,5 mm	6,4 mm	100
5541-087	7,0 - 8,2 mm	6,4 mm	100
5541-095	7,5 - 9,0 mm	7,4 mm	100
5541-010-5	8,5 - 10,0 mm	7,4 mm	100
5541-011-3	9,1 - 10,8 mm	7,4 mm	100
5541-012-3	9,8 - 11,8 mm	7,4 mm	100
5541-012-8	10,3 - 12,3 mm	7,4 mm	100
5541-013-3	10,6 - 12,6 mm	8,2 mm	100
5541-013-8	11,1 - 13,1 mm	8,2 mm	100
5541-014-5	11,8 - 13,8 mm	8,2 mm	100
5541-015-0	12,3 - 14,8 mm	8,2 mm	50
5541-015-5	12,8 - 14,8 mm	8,2 mm	50
5541-016-0	13,1 - 15,3 mm	8,2 mm	50
5541-016-8	13,9 - 16,1 mm	8,2 mm	50
5541-017-5	14,6 - 16,8 mm	8,2 mm	50
5541-019-5	16,5 - 18,8 mm	8,2 mm	100
5541-021-0	18,0 - 20,3 mm	8,2 mm	50
5541-025-5	22,0 - 24,8 mm	8,2 mm	50

02

**Hose clamps mini**► **Technical specifications**

- embossed tape
- with slotted head screw
- Band width 5mm



Item No.	Clamping range	PU
5541-7-11	7 - 11 mm	50
5541-9-16	9 - 14 mm	50
5541-10-19	10 - 19 mm	50

03

**Clic-R hose clamps**

completely made of rustproof chrome nickel steel Technical specifications

- Main and loading tasks of these clamps:
- secure hold of the hose on the connector
- Tightness of the hose / connecting piece connection at temperatures
- between -30 ° C and 130 ° C
- Minimum tear strength of the hose from the nozzle: 200N
- Vibration resistance
- Resistant to gasoline, diesel fuel, coolant



Item No.	Closed Ø	Ø range	Bandwidth	colour	PU
5537-066-70	7,0 mm	7,7 - 9,0 mm	6 mm	black	50
5537-066-90	9,0 mm	9,5 - 11,0 mm	6 mm	purple	50
5537-066-105	10,5 mm	11,0 - 12,5 mm	6 mm	yellow	50
5537-086-115	11,5 mm	12,0 - 13,5 mm	8 mm	purple	50
5537-086-120	12,0 mm	12,5 - 14,0 mm	8 mm	black	50
5537-086-125	12,5 mm	13,0 - 14,5 mm	8 mm	white	50
5537-086-130	13,0 mm	13,5 - 15,0 mm	8 mm	yellow	50
5537-086-140	14,0 mm	14,5 - 16,0 mm	8 mm	purple	50
5537-086-150	15,0 mm	15,5 - 17,0 mm	8 mm	white	50
5537-086-160	16,0 mm	16,0 - 18,0 mm	8 mm	green	50
5537-086-165	16,5 mm	17,0 - 19,0 mm	8 mm	purple	50
5537-086-185	18,5 mm	19,0 - 21,0 mm	8 mm	green	50
5537-096-235	23,5 mm	23,5 - 25,5 mm	8 mm	silver	25

04

**Hand pliers straight**

for Clic-R clamps

- Item no. 5537-1-75



05

**Bent hand pliers**

for Clic-R clamps

- Item no. 5537-2-75





01

**Pipe clamps**

rubberized

► **Technical specifications**

- completely galvanized
- RSGU
- rubberized



Item No.	Pipe Ø	Bandwidth	Hole Ø	PU
5542-6-12	6 mm	12 mm	5,3 mm	50
5542-6-15	6 mm	15 mm	6,4 mm	50
5542-8-12	8 mm	12 mm	5,3 mm	50
5542-8-15	8 mm	15 mm	6,4 mm	50
5542-8-20	8 mm	20 mm	8,4 mm	50
5542-9-12	9 mm	12 mm	5,3 mm	50
5542-10-12	10 mm	12 mm	5,3 mm	50
5542-10-15	10 mm	15 mm	6,4 mm	50
5542-12-12	12 mm	12 mm	5,3 mm	50
5542-12-15	12 mm	15 mm	6,4 mm	50
5542-15-12	15 mm	12 mm	5,3 mm	25
5542-15-15	15 mm	15 mm	6,4 mm	25
5542-15-20	15 mm	20 mm	8,4 mm	25
5542-18-15	18 mm	15 mm	6,4 mm	25
5542-20-15	20 mm	15 mm	6,4 mm	25
5542-20-20	20 mm	20 mm	8,4 mm	25
5542-25-12	25 mm	12 mm	5,3 mm	25
5542-25-15	25 mm	15 mm	6,4 mm	25
5542-25-20	25 mm	20 mm	8,4 mm	10
5542-30-15	30 mm	15 mm	6,4 mm	10
5542-30-20	30 mm	20 mm	8,4 mm	10
5542-35-15	35 mm	15 mm	6,4 mm	10
5542-40-20	40 mm	20 mm	8,4 mm	10
5542-50-15	50 mm	15 mm	6,4 mm	10

02

**Breeze clamps**► **Technical specifications**

- Strap and case: stainless steel A2
- Screw: steel, zinc-plated, slotted hexagon screw
- Screw thread, belt width 14.3 mm
- Width across flats 8 mm



Item No.	Clamping range	PU
5547-11-20	10 - 20 mm	25
5547-16-25	16 - 25 mm	25
5547-20-32	20 - 32 mm	25
5547-25-40	25 - 40 mm	25
5547-32-50	35 - 50 mm	25
5547-40-60	40 - 60 mm	25
5547-50-70	50 - 70 mm	25
5547-60-80	60 - 80 mm	25
5547-70-90	70 - 90 mm	25
5547-80-100	80 - 100 mm	10
5547-90-110	90 - 110 mm	10
5547-100-120	100 - 120 mm	10
5547-110-130	110 - 130 mm	10
5547-120-140	120 - 140 mm	10

01

**Heavy duty hose clamps, pivot bolt clamps**► **Technical specifications**

- Hinge and lock made of W2 / DIN 1.4016
- Galvanized steel screw
- very high breaking torque
- very high belt tension
- Special screw with integrated spacer tube and hexagon socket
- reinforced tape loops
- mechanical suspension without welding points and contact corrosion
- Bridge with hose protection
- Robust tape with rounded edges prevents injuries and hose damage
- Hollow bolts reduce the tensile force on the screw and mechanical lock



Item No.	Clamping range	Bandwidth	PU
5543-19-21	19-21 mm	18 mm	10
5543-23-25	23-25 mm	18 mm	10
5543-25-27	25-27 mm	18 mm	10
5543-29-31	29-31 mm	18 mm	10
5543-34-37	34-37 mm	18 mm	10
5543-40-43	40-43 mm	18 mm	10
5543-47-51	47-51 mm	20 mm	10
5543-55-59	55-59 mm	20 mm	10
5543-63-68	63-68 mm	20 mm	10
5543-73-79	73-79 mm	25 mm	10
5543-85-91	85-91 mm	25 mm	5
5543-97-104	97-104 mm	25 mm	5
5543-112-121	112-121 mm	25 mm	5
5543-140-150	140-150 mm	30 mm	5
5543-150-162	150-162 mm	30 mm	5

02

**Audi pipe clamp**

complete with screw, nut and spring washer

► **Technical specifications**

- all parts galvanized (flat round head screw / carriage bolt)
- The clamp is screwed to DIN parts



Item No.	Ø in mm	PU
5883-082	42,5	10
5883-080	45,5	10
5883-086-2	46,7	10
5883-086-3	48,5	10
5883-086-5	51,5	10
5883-086-7	54,5	10

03

**Tubular clamps**► **Technical specifications**

- Thread type: metric thread
- Material: steel
- Surface: galvanized



Item No.	Ø in mm	PU
5883-6	42	10
5883-7	45	10
5883-8	48	10
5883-85	50	10
5883-9	52	10
5883-10	54	10
5883-11	58	10
5883-12	60	10

04

**Pipe clamps Ford**► **Technical specifications**

- completely mounted
- copper-plated safety nuts
- for Ford silencer
- material: steel
- Surface: galvanised



Item No.	Ø in mm	PU
5883-043	43	10
5883-045	45	10
5883-048	48	10
5883-050	50	10
5883-051	51	10
5883-053	53	10
5883-055	55	10
5883-058	58	10
5883-060	60	10
5883-062	62	10



01

**Fuel hose top sheet**

-40 ° C to 90 ° C for a short time 150 ° C

► **Technical specifications**

- Hose core: NBR compound, fuel and oil resistant (nitrile rubber).
- Outer layer: CR compound (chloroprene rubber)
- abrasion, ozone, weather and oil resistant
- Insert: textile braid (CV/viscose)
- Colour / Marking: black / Marking DIN-compliant
- Temperature resistance : permanently -40°C to +90°C, briefly: up to +110°C
- Cold behaviour : filled with FAM test fuel and bending radii according to table
- at -40°C; unfilled at -25°C
- Test pressure (tightness): water: 20 bar over 30 - 40 seconds (inner diameter 17 mm)
- Operating pressure: 10 bar
- Bursting pressure: 30 bar

Item No.	Inside-Ø	Wall thickness	length	PU
5897-055-10	5,5 mm	3,0 mm	10 m	1
5897-075-10	7,5 mm	2,75 mm	10 m	1
5897-075-010	7,5 mm	3,0 mm	10 m	1
5897-095-10	9,5 mm	3,0 mm	10 m	1



02

**Fuel hose yarn braid**

-40°C to 85°C, briefly up to +110°C

► **Technical specifications**

- Inner tube: NBR mixture, fuel and oil resistant (nitrile rubber)
- Yarn braid: > CO <(cotton)
- Color / marking: black / labeling conforms to DIN
- Technical specifications :
- Temperature resistance: permanent temperature -40 ° C to 85 ° C
- Short-term peak temperature up to 110 ° C
- Cold behavior: filled with FAM test fuel and 180 ° bend at -40 ° C;
- unfilled at -30 ° C
- (not for hoses > 15 mm inside diameter)
- Test pressure (tightness): Water: 20 bar for 30 - 40 seconds
- Operating pressure: 10 bar
- Burst pressure: 30 bar

Item No.	Inside-Ø	Wall thickness	length	PU
5897-132-10	3,2 mm	2,0 mm	10 m	1
5897-135-10	3,5 mm	2,0 mm	10 m	1
5897-145-10	4,5 mm	2,5 mm	10 m	1
5897-155-10	5,5 mm	2,5 mm	10 m	1
5897-175-10	7,5 mm	2,5 mm	10 m	1
5897-195-10	9,5 mm	2,75 mm	10 m	1
5897-112-5	12,0 mm	3,0 mm	5 m	1



03

**Fuel hoses ECO**

yarn braid - OEM quality

► **Technical specifications**

- yarn braid
- Temperature resistant up to 150 ° C
- suitable as a diesel return line
- Connection and vacuum hose with high temperature loads
- OEM quality

Item No.	Inside-Ø	Wall thickness	length	PU
5895-205	3,0 mm	7,5 mm	10 m	1
5895-206	3,5 mm	7,5 mm	10 m	1



04

**Fuel hose ECO**

-40 ° C to 90 ° C for a short time 110 ° C

► **Technical specifications**

- ECO, with textile braiding outside
- Type B according to DIN 73379

Item No.	Inside-Ø	Wall thickness	length	PU
5897-230	3,0 mm	7,0 mm	20 m	1



01

**Vacuum hoses without braided textile insert**

TYPE 2A - DIN 79979

## ► Technical specifications

- NBR hose without textile braid (nitrile butadiene rubber)
- NOT UV-resistant
- Operating pressure: 1 bar
- Specification according to DIN73379-2 type C-NBR
- Tolerances according to DIN 1307
- Operating temperature: -25 ° C to 90 ° C
- briefly up to: 110 ° C
- Burst pressure: 6 bar
- 20 m on the roll
- Fuel resistance tested with up to 10% ethanol

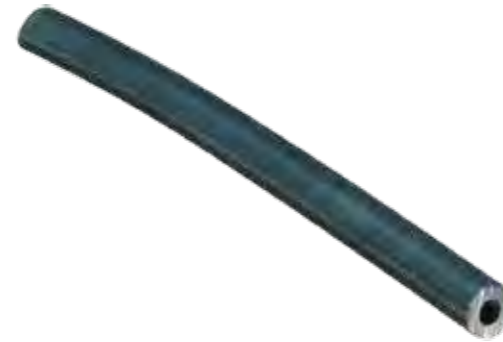

Item No.	Inside-Ø	Wall thickness	length	PU
5897-325	2,5 mm	1,75 mm	20 m	1
5897-380	8,0 mm	3,0 mm	20 m	1

02

**PVC tubing with fabric**

Compressor hose PVC with fabric, transparent

## ► Technical specifications

- Material: soft PVC
- Shore hardness: approx. 78 ° Shore A
- Composition: PVC / lubricant / DOP plasticizer / organo tin stabilizer (cadmium-free)
- Density: 1.19 g / cm<sup>3</sup>
- thermal application range: -20 ° C to 65 ° C
- Tolerances: according to DIN / EN 16940
- Short-term pressure load: 10 bar at 20 ° C ambient temperature and flow medium according to the overview
- Flammability: The material is hardly inflammable and self-extinguishing after removing the flame



Item No.	Inside-Ø	Wall thickness	length	PU
5895-45-80	4,0 mm	3 mm	15 m	1

03

**Vacuum hose NBR**

## ► Technical specifications

- Inner tube: NBR mixture
- Color / marking: black / material, dimensions
- Temperature resistance: permanent temperature up to 50 ° C
- Short-term peak temperature up to 90 ° C
- Cold behavior: down to -30 ° C
- Operating pressure: pressureless
- adequate resistance to fuel and oil



Item No.	Article name	execution
5897-333-10		
5897-337-10		
5897-335-10		
5897-350-10		

04

**Braided hose**

## ► Technical specifications

- Material: PET (extremely resilient)
- Special features: flame retardant, halogen-free
- Operating temperature min.: -40 ° C
- Operating temperature max.: +150 ° C



Item No.	execution	length	PU
3505-2-6		10 m	1
3505-2-8		10 m	1
3505-2-11		10 m	1
3505-2-18		5 m	1
3505-2-26		5 m	1
3505-2-30		5 m	1
3505-2-36		5 m	1



01

**PVC hose**

crystal clear

► **Technical specifications**

- silicone free
- food safe according to RoHS3 and REACH
- Material: soft PVC
- Shore hardness: approx. 78 ° Shore A
- Composition: PVC / lubricant / DOP plasticizer / organo-tin stabilizer (cadmium-free)
- Density: 1.19 g / cm<sup>3</sup>
- thermal application range: -20 ° C to 65 ° C
- Tolerances: according to DIN / EN 16940
- Short-term pressure load: at 20 ° C ambient temperature and flow medium as per overview
- Flammability: the material is flame-retardant and self-extinguishing when the flame is removed

Item No.	Wall thickness	Inside-Ø [mm]	length
5895-3	1,0 mm	3,0	15 m
5895-4	1,0 mm	4,0	15 m
5895-5	1,0 mm	5,0	15 m
5895-6	1,0 mm	6,0	15 m
5895-8	1,0 mm	8,0	15 m
5895-10	1,5 mm	10,0	10 m
5895-12	1,5 mm	12,0	10 m



02

**Reduction hose connector**► **Technical specifications**

- Intermediate pieces for connecting different hose diameters

Item No.	for hose Ø	PU
5896-504-3	4 - 3 mm	25
5896-506-4	6 - 4 mm	25
5896-508-4	8 - 4 mm	25
5896-508-6	8 - 6 mm	25
5896-510-8	10 - 8 mm	25



03

**Hose connector straight**► **Technical specifications**

- Oil and fuel resistant in the following temperature range: permanently -40 ° C to 80 ° C / briefly (up to 1h) up to max. 110 ° C
- high strength
- toughness
- light weight
- Damping ability
- Abrasion resistance
- great impact resistance

Item No.	for hose Ø	PU
5896-103	3 mm	25
5896-104	4 mm	25
5896-105	5 mm	25
5896-106	6 mm	25
5896-108	8 mm	25
5896-110	10 mm	25

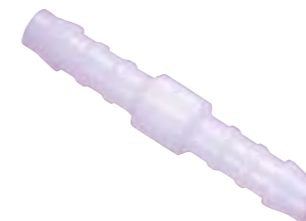

05

**Angle hose connector**► **Technical specifications**

- Oil and fuel resistant in the following temperature range: permanently -40 ° C to 80 ° C / briefly (up to 1h) up to max. 110 ° C
- high strength
- toughness
- light weight
- Damping ability
- Abrasion resistance
- great impact resistance

Item No.	for hose Ø	PU
5896-303	3 mm	25
5896-304	4 mm	25
5896-305	5 mm	25
5896-306	6 mm	25



04

**T-hose connector**► **Technical specifications**

- Oil and fuel resistant in the following temperature range: permanently -40 ° C to 80 ° C / briefly (up to 1h) up to max. 110 ° C
- high strength
- toughness
- light weight
- Damping ability
- Abrasion resistance
- great impact resistance

Item No.	for hose Ø	PU
5896-203	3 mm	25
5896-204	4 mm	25
5896-205	5 mm	25
5896-206	6 mm	25
5896-208	8 mm	25
5896-210	10 mm	25

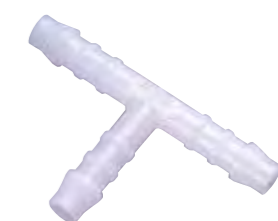

06

**Y-hose connector**► **Technical specifications**

- Oil and fuel resistant in the following temperature range: permanently -40 ° C to 80 ° C / briefly (up to 1h) up to max. 110 ° C
- high strength
- toughness
- light weight
- Damping ability
- Abrasion resistance
- great impact resistance

Item No.	for hose Ø	PU
5896-403	3 mm	25
5896-404	4 mm	25
5896-405	5 mm	25
5896-406	6 mm	25
5896-408	8 mm	25
5896-410	10 mm	25





01

**Plastic hose connector assortment**

160 pieces

► Item no. 1957-896

## ► Content:

- 10 x straight hose connector 3mm (Art.-No. 5896-103)
- 10 x straight tube connector 4mm (Art.-No. 5896-104)
- 10 x straight tube connectors 5mm (Art.-No. 5896-105)
- 10 x straight tube connectors 6mm (Art.-No. 5896-106)
- 10 x T-hose connector 3mm (Art.-No. 5896-203)
- 10 x T-tube connector 4mm (Art.-No. 5896-204)
- 10 x T-tube connector 5mm (Art.-No. 5896-205)
- 10 x T-hose connector 6mm (Art.-No. 5896-206)
- 10 x angled hose connectors 3mm (Art.-No. 5896-303)
- 10 x angled hose connectors 4mm (Art.-No. 5896-304)
- 10 x angled hose connectors 5mm (Art.-No. 5896-305)
- 10 x angled hose connectors 6mm (Art.-No. 5896-306)
- 10 x Y-hose connector 3mm (Art.-No. 5896-403)
- 10 x Y-hose connector 4mm (Art.-No. 5896-404)
- 10 x Y-tube connector 5mm (Art.-No. 5896-405)
- 10 x Y-hose connector 6mm (art.-no. 5896-406)







01

**Brake lines**► **Technical specifications**

- Material: copper
- Surface: nickel alloy
- Complies with the standards DIN / EN 1754, 1787, 17671, 74234 and EN 10204



Item No.	Outside Ø	Wall thickness	length	PU
5885-090	4,75 mm	0,71 mm	5 m	1
5885-091	6,0 mm	0,71 mm	10 m	1

02

**Brake line nipple with internal thread**

Item No.	SW	Inside-Ø	length	thread	PU
5885-105	14 mm	M10 x 1	13 mm	M10	10
5885-107	14 mm	3/8" x 24UNF	17,5 mm	3/8"	10
5885-108	15 mm	M10 x 1	23 mm	M10	10



03

**Brake line extension with internal thread**

Item No.	SW	execution	pitch	Inside-Ø	length	thread	PU
5885-201	17 mm	metric	1 mm	4,0 mm	29 mm	M12	10
5885-200	Spare plate for mini polishing machine		metric	1 mm	3,5 mm	24 mm M10	10
5885-203	Spare plate for mini polishing machine		inch	0,375 in	3,1 mm	33,2 mm 3/8"	10



04

**Brake line nipple with external thread**

Item No.	SW	pitch	Outside Ø	length	thread	Vehicle type	PU
5885-101	12 mm	1 mm	M12 x 1	20 mm	M12	Alfa, Audi, Citroen, Fiat, Ford, Honda, Opel, Peugeot, Renault, Rover, Seat, Skoda, Saab, Volvo, VW	10
5885-102	11 mm	1 mm	M10 x 1	24,8 mm	M10	Fiat	10
5885-103	10 mm	1 mm	M10 x 1	16,7 mm	M10	Daihatsu, Hyundai, Nissan, Opel, Skoda, Toyota, Vauxhall, VW	10
5885-104	10 mm	1 mm	M10 x 1	23 mm	M10	Toyota VW	10
5885-106	11 mm	24 UNF	3/8" x 24 UNF	21 mm	3/8"	Bedford, Renault, Rover, Saab, Talbot, Vauxhall, Volvo	10
5885-109	10 mm	1,25 mm	M10 x 1,25	19,5 mm	M10	Autobianchi, Dacia, Fiat, Lada, Lancia, Zastava	10
5885-110	10 mm	1,25 mm	M10 x 1,25	14,2 mm	M10	Mazda	10
5885-111	13 mm	20 UNF	1/2" x 20 UNF	18 mm	1/2"	Peugeot	10
5885-112	10 mm	1 mm	M10 x 1	18 mm	M10	Daihatsu, Honda, Hyundai, Isuzu, Mazda, Mitsubishi, Nissan, Opel, Suzuki, Toyota, VW	10
5885-113	12 mm	1 mm	M12 x 1	18 mm	M12		10

05

**Brake line extension with external thread**

Item No.	SW	execution	pitch	Inside-Ø	length	thread	PU
5885-202	11 mm	Metric	1 mm	3,2 mm	28 mm	M10	10
5885-204	11 mm	inch	0,375 in	3,2 mm	28 mm	3/8"	10

01

**Axle boot set, universal**

suitable for all cars

▶ Item no. 5884-900

▶ Technical specifications

- for assembly without dismantling the cardan and axle joints
- suitable for all cars
- oil and grease resistant
- Suitable for all common front and rear wheel cardan joints
- at the narrowest point the axle sleeve has a diameter of approx. 21mm
- 
- Scope of delivery:
  - 1 x universal axle boot
  - 1 x universal hose clamp, large
  - 1 x universal hose clamp, small
  - 1 x high temperature joint fat



02

**Axle boot set, universal**

Suitable for all cars and vans up to 3.5 t

▶ Item no. 5884-901

▶ Technical specifications

- for assembly without dismantling the cardan and axle joints
- Suitable for all cars and vans up to 3.5 t
- oil and grease resistant
- Suitable for all common front and rear wheel cardan joints
- 
- Scope of delivery:
  - 1 x universal axle boot
  - 1 x universal hose clamp, large
  - 1 x universal hose clamp, small
  - 1 x high temperature joint fat

04

**Clamps for axle boots**

Item No.	Ø mm	PU
5550-884-31	31	25
5550-884-33	33	25
5550-884-35	35	25
5550-884-88	88	25
5550-884-97	97	25



05

**Steel cable ties**

6 x 380 mm

▶ Item no. 5884-909

▶ PU: 25

▶ Technical specifications

- for diameters from 60 mm to 120 mm



06

**Steel cable ties**

self-locking

Item No.	Bandwidth	length	PU
5550-46-127	4,6 mm	127 mm	25
5550-46-201	4,6 mm	201 mm	25
5550-46-360	4,6 mm	360 mm	50
5550-46-521	4,6 mm	521 mm	20
5550-79-201	7,9 mm	201 mm	25
5550-79-362	7,9 mm	362 mm	50







**01 Exhaust repair paste**  
asbestos free

- ▶ Item no. 2893-148
- ▶ Content: 150 g
- ▶ Quantity per box: 12

- ▶ Technical specifications
- fast drying
- pasty
- asbestos free



**02 Exhaust assembly paste**  
asbestos free

- ▶ Item no. 2893-149-1
- ▶ Content: 150 g
- ▶ Quantity per box: 12

- ▶ Technical specifications
- fast drying
- pasty
- asbestos free
- for sealing joints



**03 Exhaust lock nut**  
Opel, FK 8, copper-plated

Item No.	thread	height	SW	Original no.	PU
6365-61	M8	8 mm	17 mm	2066915, 2066156	100
6365-65	M10	10 mm	21 mm	854976, 90108169	100



**04 Exhaust flange nut**  
Opel, FK 8, copper-plated

Item No.	thread	height	SW	Original no.	PU
6365-6	M8	10 mm	17 mm	854906	100



**05 EXHAUST FLANGE NUTS**  
BMW, Mercedes-Benz, FK 8, copper-plated

Item No.	thread	height	SW	Original no.	PU
6365-8	M8	8,6 mm	17 mm	11621711954/	100



**06 Slotted nuts 14440**  
normal wrench size, DIN 14440, FK 8, heavily copper-plated

Item No.	thread	height	SW	PU
6365-2	M8	1,5	13 mm	100
6365-3	M10	1,5	17 mm	100



**07 Slotted round nuts**  
Thermag, DIN 14441 - reduced wrench size

Item No.	thread	SW	height	PU
6366-2	M8 x 1,25	12	8,5	100
6366-3	M10	14	10,5	100
6366-7	M10 x 1,25	14	10,5	100
6366-8	M8 X 1	12	8,5	100



01

**Thread inserts**► **Technical specifications**

- Installation in the following materials:

- Light metal alloys
- Cast iron, brass, bronze, non-ferrous metals
- Plastics laminates
- Hardwoods

-

- Applications:

- Automotive industry and truck construction: engine, transmission, many supplier parts such as exterior mirrors, radiators, bumpers, etc.
- Plant and equipment construction: flange connections, construction equipment, oil burners, etc.
- Electrical and laboratory technology: capacitors, high voltage, radio and telephone systems, dental equipment
- Military area: tanks, planes, etc.
- Material: case-hardened steel, galvanized, yellow chromated
- Tolerances: ISO 2768-m



Item No.	IG version	Execution AG	PU
5660-3	M3 x 0,5	5,0 x 0,5	1
5660-4	M4 x 0,7	6,5 x 0,75	1
5660-5	M5 x 0,8	8,0 x 1,0	1
5660-6	M6 x 1,0	10,0 x 1,5	1
5660-8	M8 x 1,25	12,0 x 1,5	1
5660-10	M10 x 1,5	14,0 x 1,5	1
5660-12	M12 x 1,75	16,0 x 1,5	1
5660-14	M14 x 2,0	18,0 x 1,5	1

02

**Screwing tool for manual assembly**  
for threaded inserts

Item No.	IG version	Execution AG	PU
5660-103	M3 x 0,5	5,0 x 0,5	1
5660-104	M4 x 0,7	6,5 x 0,75	1
5660-105	M5 x 0,8	8,0 x 1	1
5660-106	M6 x 1,0	10,0 x 1,5	1
5660-108	M8 x 1,25	12,0 x 1,5	1
5660-110	M10 x 1,5	14,0 x 1,5	1
5660-112	M12 x 1,75	16,0 x 1,5	1
5660-114	M14 x 2,0	18 x 1,5	1

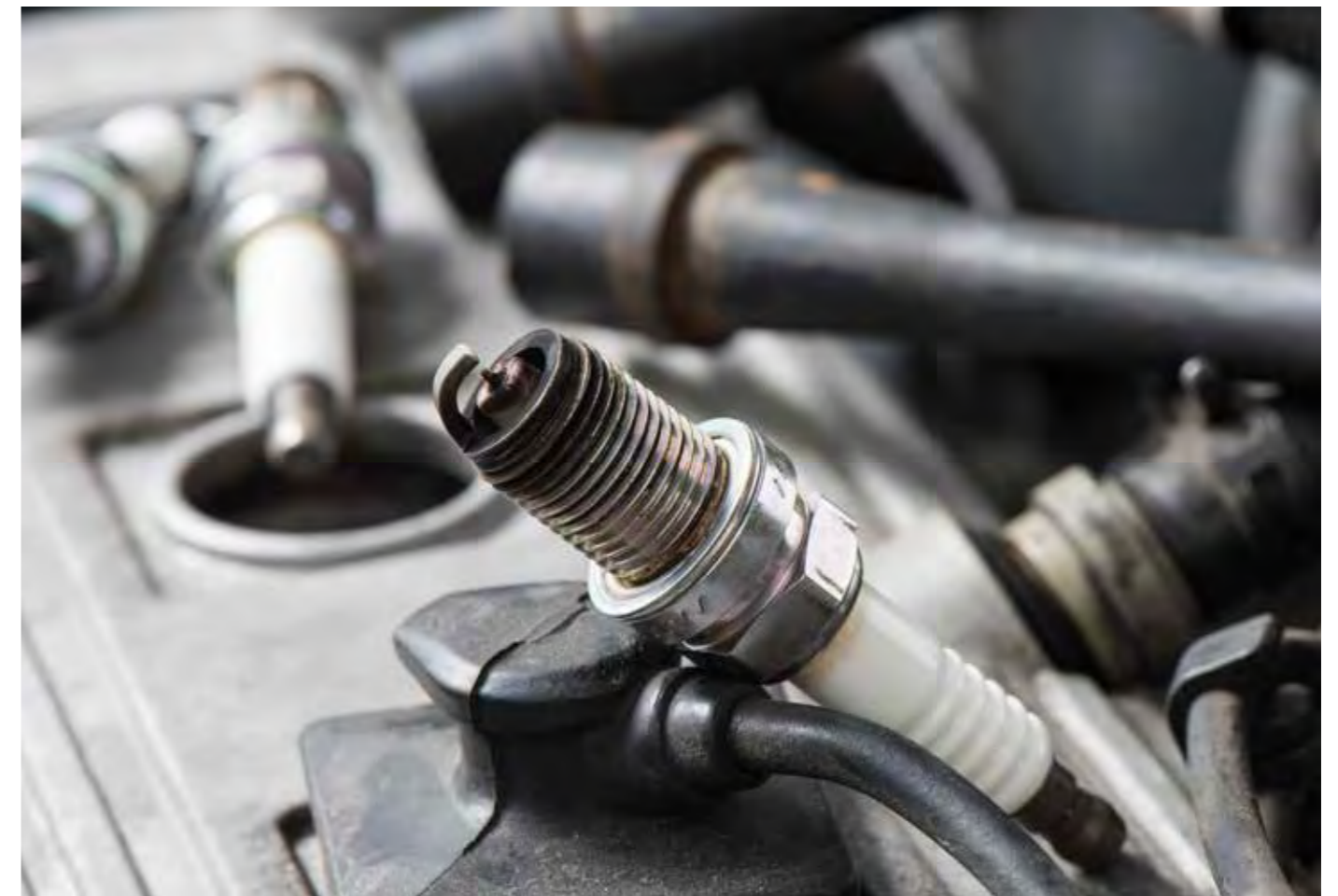

03

**Spark plug inserts**

Item No.	execution	PU
5660-014	M14,1.25 / 9	10
5660-018	M18,1.50 / 9	5



04

**Screwing tool for manual assembly**  
for spark plug thread inserts

Item No.	execution	PU
5660-114-1	M14 x 1.25	1
5660-118-1	M18 x 1.50	1





01

**Lubricator nipple**DIN 71412 A, H1, galvanised,  
hardened, surface chromated

02

**Lubricator nipple**

DIN 71412, H 2



03

**Lubricator nipple**

DIN 71412, H 3



Item No.	execution	PU	Item No.	execution	PU	Item No.	execution	PU
6986-40	M6 x 1	50	6986-50	M6 x 1	50	6986-60	M6 x 1	50
6986-41	M8 X 1	50	6986-51	M8 X 1	50	6986-61	M8 X 1	50
6986-42	M10 x 1	50	6986-52	M10 x 1	50	6986-62	M10 x 1	50

04

**Adapter sleeves**

Item No.	Ø mm	Length [mm]	PU
6476-2-20	2	20	100
6476-2-30	2	30	100
6476-3-20	3	20	100
6476-3-40	3	40	100
6476-4-40	4	40	100
6476-4-60	4	60	100
6476-5-30	5	30	50
6476-5-40	5	40	50
6476-5-60	5	60	50
6476-6-40	6	40	50
6476-6-50	6	50	50
6476-6-60	6	60	50
6476-8-40	8	40	25
6476-8-50	8	50	25
6476-8-60	8	60	25
6476-10-60	10	60	20



05

**Adapter sleeve assortment**

DIN 1481, blank



► Item no. 1957-476

► Contents: 985 parts

- 100 x 2 X 20 (Item No. 6476-2-20)
- 100 x 2 X 30 (Item No. 6476-2-30)
- 100 x 3 X 20 (Item No. 6476-3-20)
- 100 x 3 X 40 (Item No. 6476-3-40)
- 100 x 4 X 40 (Item No. 6476-4-40)
- 100 x 4 X 60 (Item No. 6476-4-60)
- 50 x 5 X 30 (Item No. 6476-5-30)
- 50 x 5 X 40 (Item No. 6476-5-40)
- 50 x 5 X 60 (Item No. 6476-5-60)
- 50 x 6 X 40 (Item No. 6476-6-40)
- 50 x 6 X 50 (Item No. 6476-6-50)
- 50 x 6 X 60 (Item No. 6476-6-60)
- 25 x 8 X 40 (Item No. 6476-8-40)
- 25 x 8 X 50 (Item No. 6476-8-50)
- 25 x 8 X 60 (Item No. 6476-8-60)
- 10 x 10 X 60 (Item No. 6476-10-60)

01

**Flat head number screw**

V-shape slotted head

galvanized steel

Item No.	execution	PU
6210-46	6 x 20 mm	100
6210-42	5 x 20 mm	100



06

**License plate screw**

V-shape slotted head steel galvanised

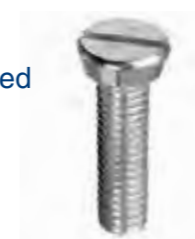

Item No.	execution	PU
6246-6-20	6 x 20 mm	100

07

**License plate screw**

Plastic PA 6.6



Item No.	Model	colour	PU
6210-078	6 x 20 mm	white	100

02

**Cap screws**

- similar to DIN 7981
- with drill point
- Pozi Drive



Item No.	thread	length	PU
6211-065-16	5,0 mm	16 mm	100
6211-065-19	5,0 mm	19 mm	100
6211-065-25	5,0 mm	25 mm	100

03

**License plate screws**

- DIN 7981
- with washer
- galvanised



Item No.	thread	length	PU
6103-055-16	5,5 mm	16 mm	100
6103-055-19	5,5 mm	19 mm	100
6103-055-25	5,5 mm	25 mm	100

04

**Cap screws DIN 7981**

- for mounting number plates
- similar to DIN 7981
- cross slot
- galvanised



Quality 4.8

Item No.	thread	length	PU
6103-48-13	4,8 mm	13 mm	100
6103-48-16	4,8 mm	16 mm	100
6103-48-19	4,8 mm	19 mm	100
6103-48-22	4,8 mm	22 mm	100
6103-56-16	5,6 mm	16 mm	100
6103-56-19	5,6 mm	19 mm	100

05

**Pan head tapping screws A2**

- with Phillips cross recess (form H)
- DIN 7981 / ISO 7049
- stainless steel



Item No.	Thread	Length	PU
6119-35-95	3,50 mm	9.5 mm	100
6119-35-13	3,50 mm	13 mm	100
6119-35-16	3,50 mm	16 mm	100
6119-42-13	4,20 mm	13 mm	100
6119-42-16	4,20 mm	16 mm	100
6119-42-19	4,20 mm	19 mm	100
6119-42-25	4,20 mm	25 mm	100
6119-48-13	4,80 mm	13 mm	100
6119-48-16	4,80 mm	16 mm	100
6119-48-19	4,80 mm	19 mm	100
6119-48-22	4,80 mm	20 mm	100
6119-48-25	4,80 mm	25 mm	100

08

**Cover caps**

for 6210, 6246

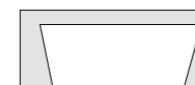

Item No.	colour	PU
6590-132-2	white	100
6590-132-3	black	100

09

**Decorative caps**

for item no. 6103-

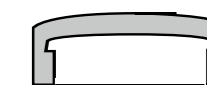

Item No.	colour	PU
6590-103	white	100
6590-10-6	black	100
6590-109	blue	100
6590-100	yellow	100

10

**Rubber gaskets**

Item No.	execution	PU
6422-65-17	6.5 x 17 x 2 mm	100
6422-65-20	6.5 x 20 x 3 mm	100

11

**Plastic distance washers**

Item No.	execution	PU
6421-06-18	18 x 7 x 6 mm	100





Vehicle parts trucks

01

**Multi-chamber light MAN**

LC8 with rear reflector, blue lighting panel and side connector plug AMP 1.5

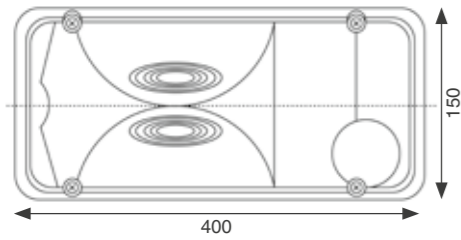

Item No.	execution
1006-47-11	left with license plate lighting
1006-47-12	right without license plate lighting
1006-47-111	Light lens left red/blue
1006-47-121	Light lens right red/blue
1006-47-122	Light lens right red/white

03

**Multi-chamber light (Europoint II)**

With 7-pin central plug

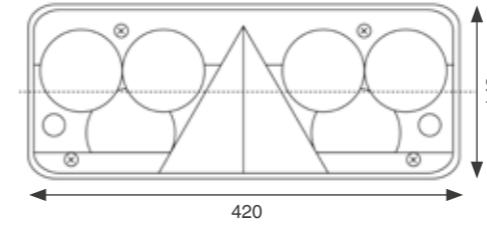

Item No.	execution
1006-39-81	Lighting panel

02

**6-chamber light**

Mercedes-Benz Actros with side compact plug, can be retrofitted to LED technology with Glowpoint base (3720-075-15)

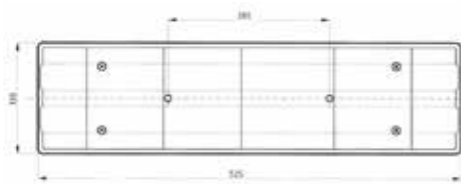

Item No.	execution
1006-37-11	Left, with number plate light
1006-37-12	Right, without number plate light
1006-36-191	Lighting panel left
1006-36-192	Lighting panel right

04

**Multi-chamber light**

Mercedes-Benz Atego with plug connection on rear of housing

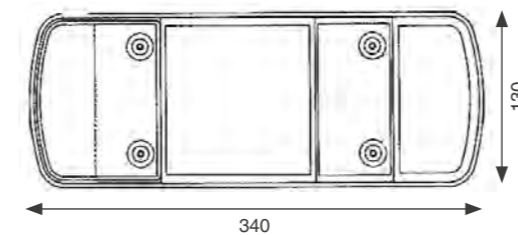

Item No.	execution
1006-46-29	Lighting panel right/left



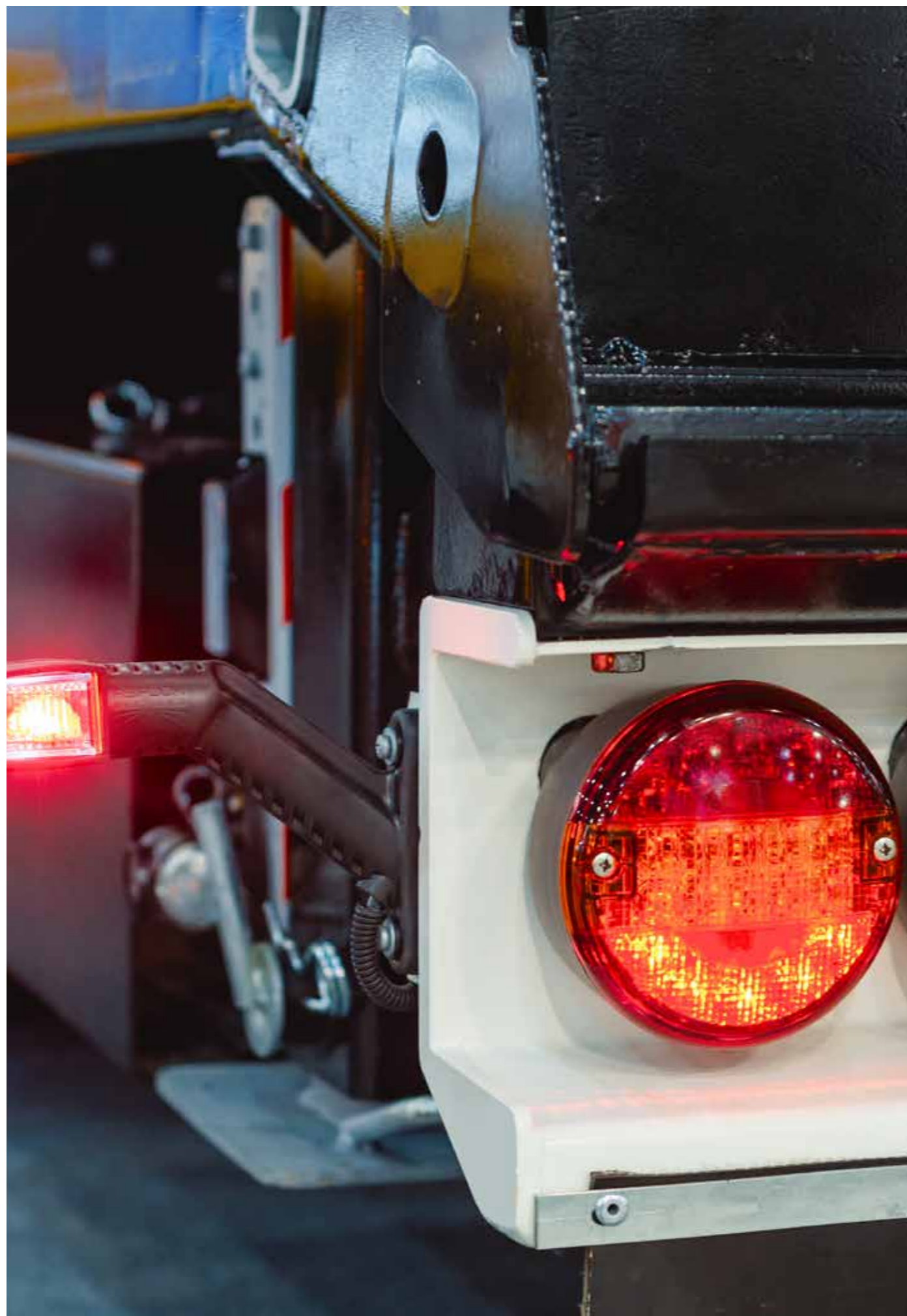

01

**Hamburger light 9-36 V**

with five functions

► Item no. 1004-70-5

► Technical specifications

- unique design
- High-performance LED technology
- Functions: light, brake light, turn signal light, rear fog light, reversing light
- Operating voltage from 9-36V
- with E-mark
- Diameter 140mm
- Construction height 25mm
- two M6 studs on the back for attachment (drill hole spacing 45mm)
- 2m long connection cable
- Turn signal: 12V-1.44W; 24V-2.88W
- Tail light: 12V-0.6W; 24V-1.3W
- Brake light: 12V-3.8W; 24V-7.7W
- Fog closure: 12V-1.25W; 24V-2.5W
- Reversing light: 12V-1.67W; 24V-3.34W



02

**Hamburger light 9-36 V**

with three functions

► Item no. 1004-70-4

► Technical specifications

- unique design
- High-performance LED technology
- Functions: light, brake light, turn signal
- Operating voltage from 9-36V
- with E-mark
- Diameter 140mm
- Construction height 25mm
- two M6 studs on the back for attachment (drill hole spacing 45mm)
- 2m long connection cable





\*\*\*???

01

**LED license plate light**  
12-24 V, right and left

► Item no. 1004-60-2

► Technical specifications

- Mounting side: right and left
- with E approval
- Voltage: 12-24V
- Wires: 13cm LgY - S 0.75mm<sup>2</sup>



02

**License plate light**  
12-24 V, black

► Item no. 1006-10-22



03

**LED license plate light**  
for cars and commercial vehicles

► Item no. 1006-10-23

► Technical specifications

- with 2 high-performance LEDs
- absolutely vibration-proof
- average Life expectancy: ? Approx. 20,000 operating hours
- Hole spacing for attachment: 72 mm



04

**LED marker light reflector**  
24V / 0.8W

► Item no. 1006-10-33

► Technical specifications

- Cable length 0.5 m
- with reflector
- White
- 90 ° cable connection using the Holtmelt process
- ADR approved, IP54
- 24 volts
- 0.8 watt

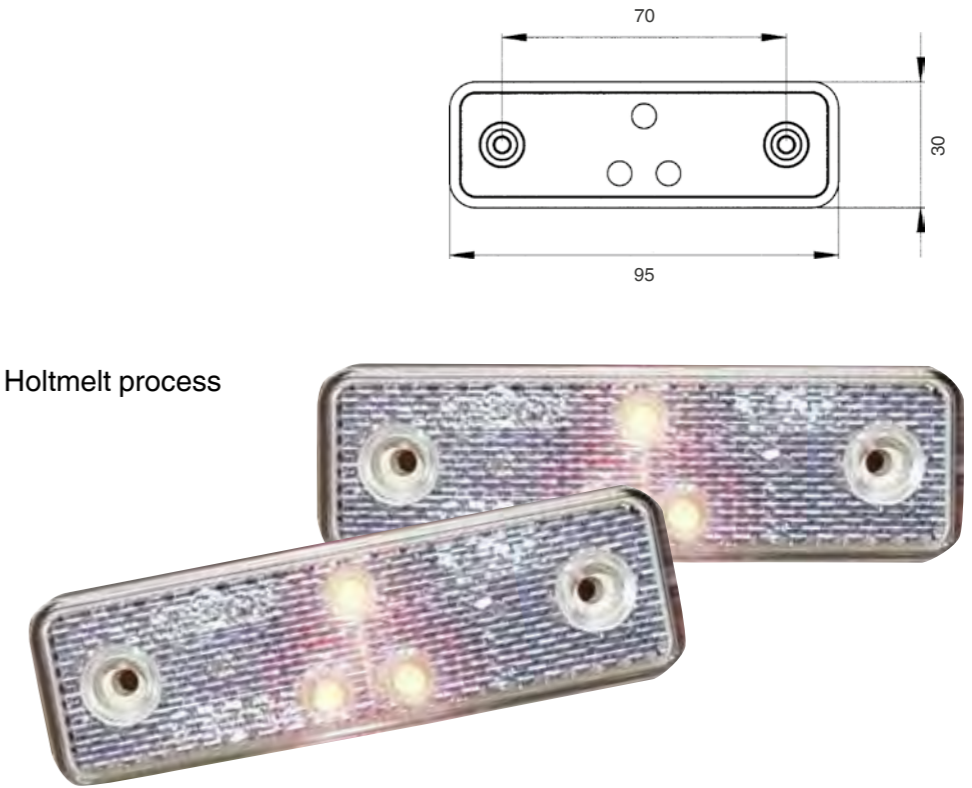

05

**Clearance light with flexible, straight bracket**  
flexible bracket

► Item no. 1006-10-20

► Technical specifications

- Hole spacing for M5 / 15 mm
- with flexible, straight bracket
- Red / white lens

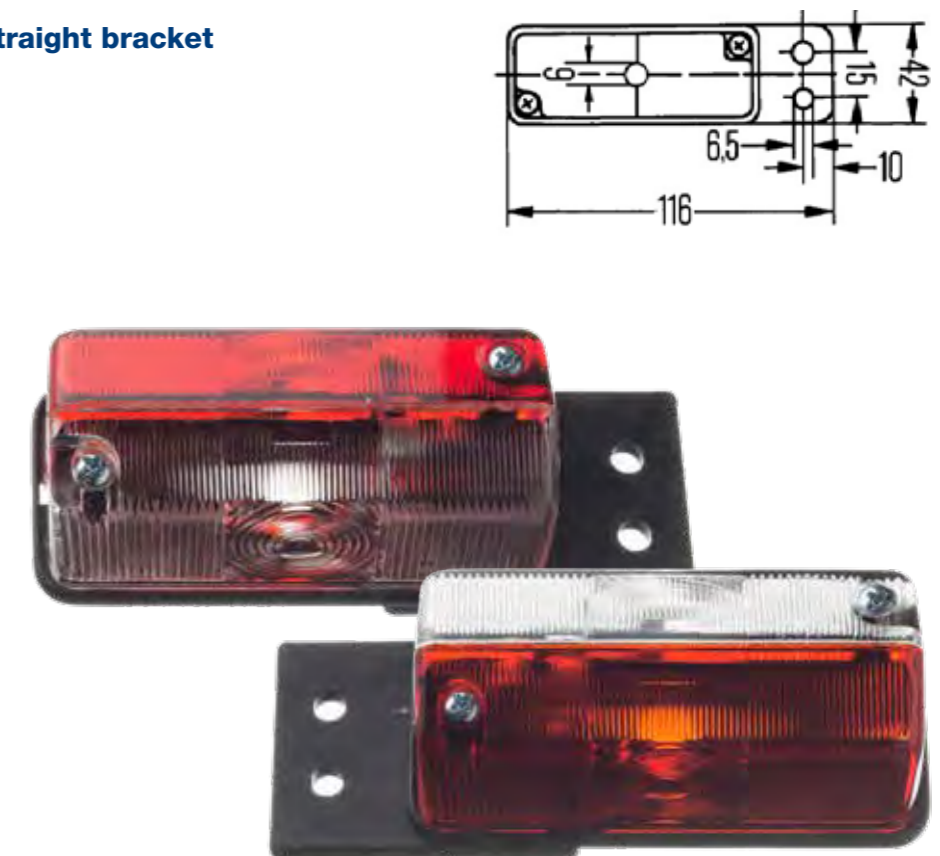



01

**LED outline marker lighting**

Front side marker and side position light

Item No.	execution
1004-90-3	left
1004-90-4	right



03

**LED clearance light**

12V / 24V

► Item no. 1004-90-1

- Technical specifications
- with flexible pendulum holder
- laterally
- Luminous color white and red
- universally applicable
- Cable length approx. 20 cm

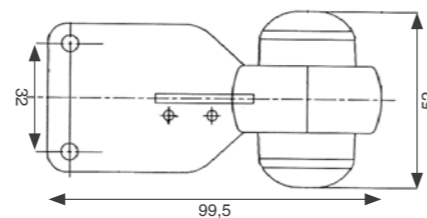

03

**LED clearance light**

Chunk

► Item no. 1004-50-1

- Technical specifications
- 12 V / 24 V
- Mounting side: left

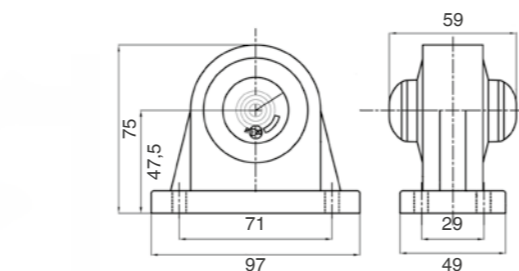

04

**LED lights**

waterproof

► Technical specifications

- With flexible mounting casing
- Light lens unit made from shatterproof PC
- For M6 fastening screws
- GGVS/ADR approved

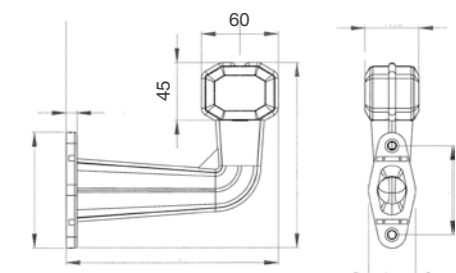

Item No. execution

1006-12-110	Angled
1006-10-3	with mountable casing
1006-12-19	LED light unit

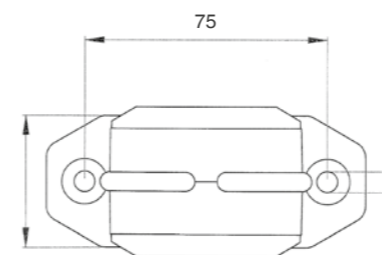

05

**Marker lighting**

Voltage: 12V or 24V

Wires: 21cm LgY - S0.75mm<sup>2</sup>

Item No. execution

1006-11-23	angled
1006-11-24	Spare socket
1006-11-253	Lens, red, Ø 55 mm on collar
1006-11-254	Lens, clear, Ø 55 mm on collar



01  
**LED marker lighting 12 V + 24 V**  
 angled

Item No.	execution
1004-50-3	left
1004-50-4	right

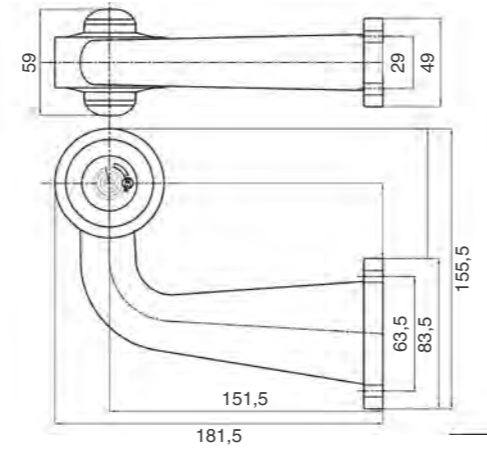

02  
**LED retrofit kit**  
 12-24 V

► Item no. 1004-50-5

- Technical specifications
- LED retrofit kit for item no. :  
 - 1004-50-3  
 - 1004-50-4  
 - 1006-11-23



03  
**LED clearance light set waterproof, angled**  
 waterproof, sloping

► Item no. 1006-13-1

- Technical specifications
- waterproof
  - Light emission: red / white / yellow
  - high light output through brilliant free-form mirror design
  - integrated LED side marker light
  - flexible, inclined mounting arm
  - flexible add-on housing
  - Lens made of break-proof polycarbonate
  - ADR approved
  - 12-24 V / 24V-1W
  - Mounting hole spacing: 78 mm
  - Cable length: 1.75 m





01

**Universal LED side marker light**  
universal, 12/24 V, with holder, 12/24 V

- ▶ Item no. 1004-20-1
- ▶ Technical specifications
- Hole spacing: 75 mm



02

**LED side marker light with bracket and 24 V cable for MAN**  
with bracket and cable (MAN), 24 V.

- ▶ Item no. 1001-179-7
- ▶ Technical specifications
- with reflector
- Repair variant
- Cable length 0.5 m



03

**LED side marker light with flashing function**  
with flashing function

- ▶ Item no. 1004-40-6
- ▶ Technical specifications
- 12V / 24V
- including holder and cable
- IP 66/68
- ECE approval
- Cable length: 22cm
- Cable: LGY-S 3x0.5mm<sup>2</sup>
- Width: 114.4 mm
- Height: 54.2 mm
- Depth: 22.3 mm
- Hole spacing: 90 mm
- Hole diameter: 4.5 mm



04

**LED side marker light**  
12-24 V, including holder and cable

- ▶ Item no. 1004-90-2
- ▶ Technical specifications
- Diode light
- Wires: 22 cm - 0.75 mm<sup>2</sup>

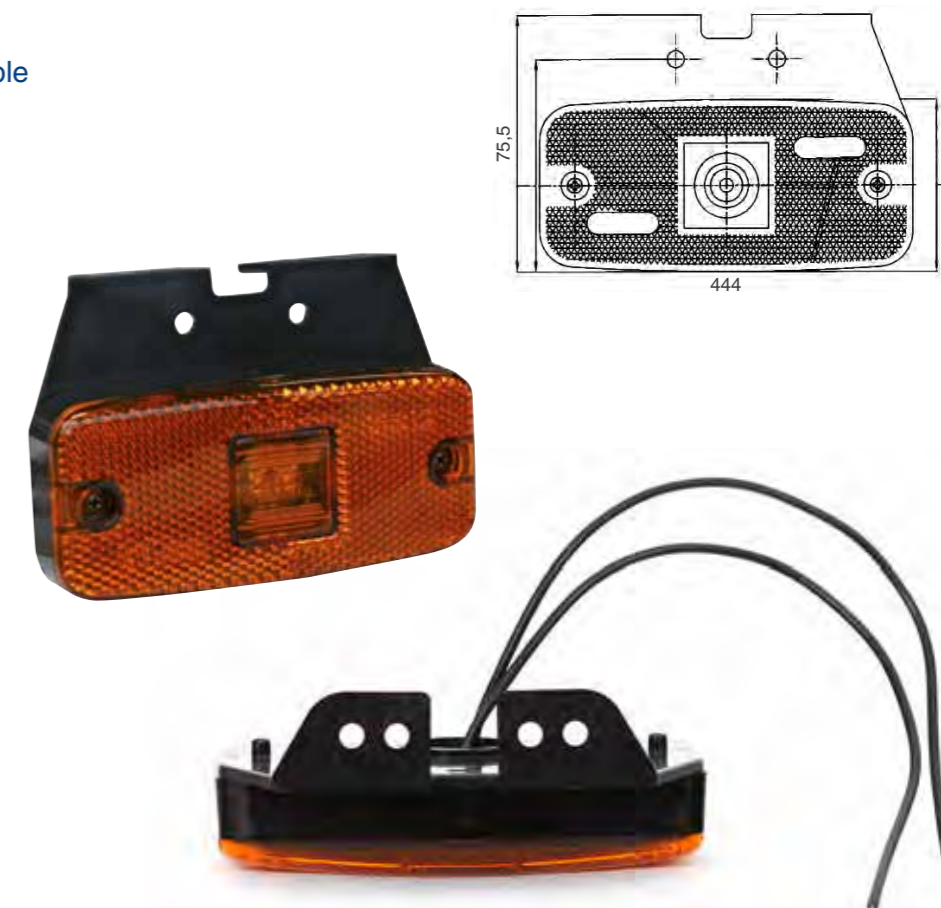



01

**Side reflector**

90 x 40 mm, with adhesive back

► **Technical specifications**

- Drill hole spacing 70 mm
- Drill hole M5
- Hole diameter [mm] 4.2
- Height [mm] 40
- Width [mm] 40
- Length [mm] 90



Item No.	execution
1001-180-41	orange/yellow
1001-180-42	red
1001-180-421	white

02

**Side reflector**

Ø 60 mm, with adhesive backing, 6 mm drill hole

Item No.	execution
1001-180-43	orange/yellow
1001-180-44	red

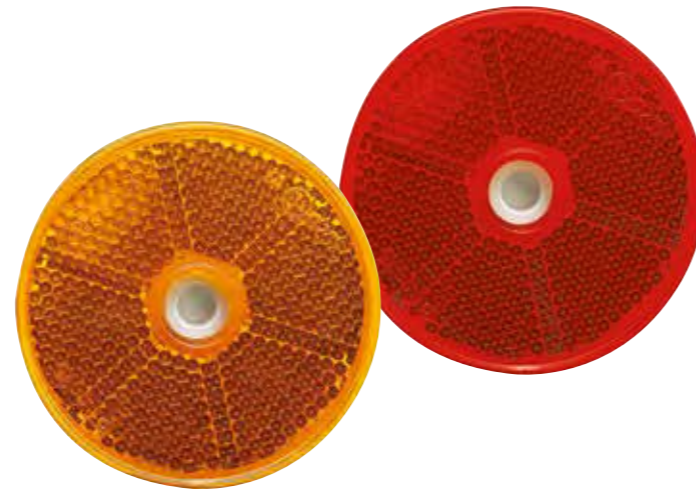

03

**Reflector Ø 90 mm**

Ø 90 mm

► **Item no. 1001-180-45**

► **Technical specifications**

- with screw and nut M5
- red

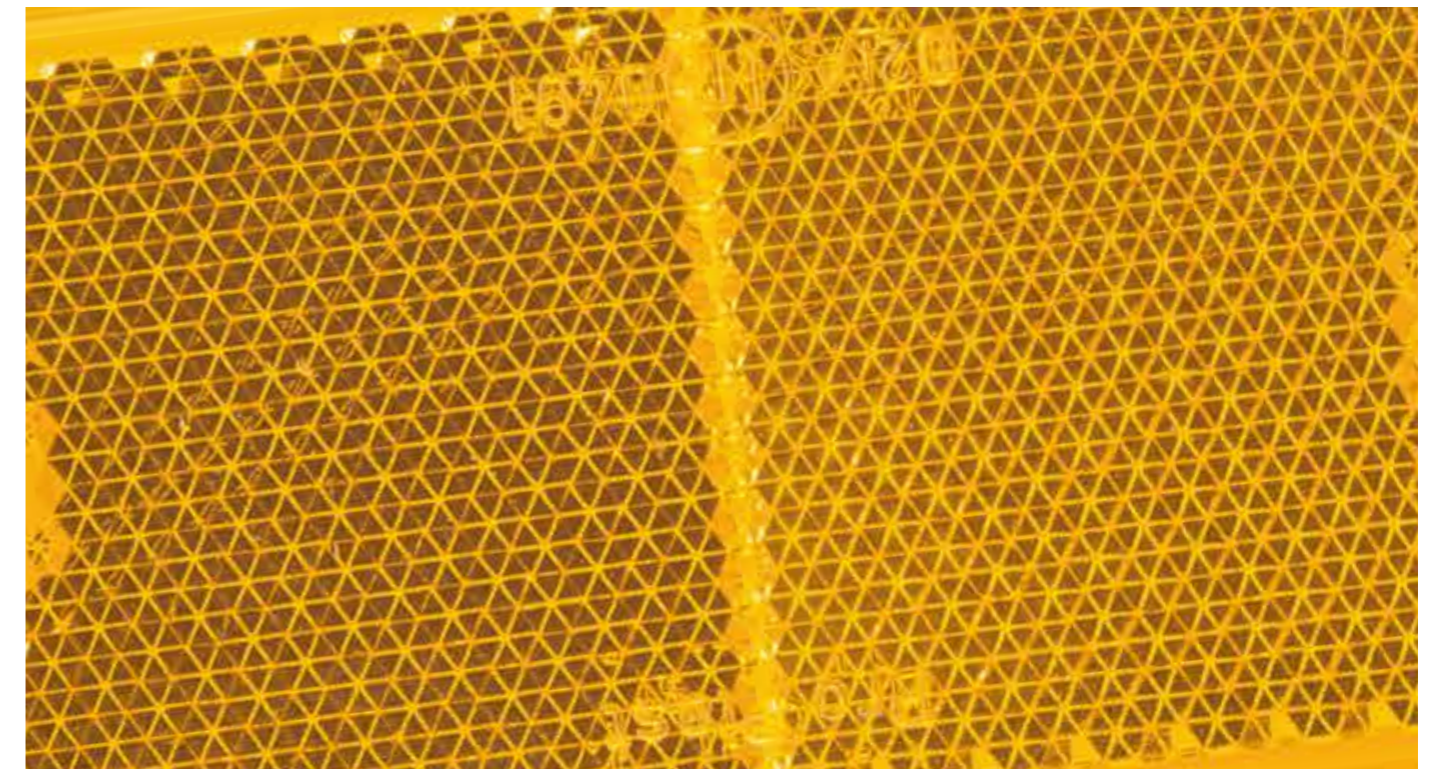

04

**1-piece triangular reflector**

1-part

► **Item no. 1001-180-50**

► **Technical specifications**

- for M6 fastening
- Hole diameter: 5.2mm
- Distance between boreholes: 70 mm
- Width: 160 mm
- Length: 139 mm
- Height: 8.5 mm



05

**4-part triangular reflector**

4 parts

► **Item no. 1001-180-51**

► **Technical specifications**

- 4 individual reflectors
- stable plastic housing
- incl. 2 fastening screws M 5 X 15 mm
- Distance between boreholes: 70 mm
- Length: 155 mm
- Width: 175 mm
- Height: 13mm





01

**LED hazard warning light**  
for lifting platforms

► Item no. 1001-188-1

► Technical specifications

- small design
- robust metal housing
- intensive light exploitation
- E-mark
- 12V and 24V
- pre-wired
- Supply line 3x1.5
- 30cm long



02

**Flashing hazard warning light**  
with 2 LEDs

► Item no. 1001-186-1

► Technical specifications

- Operating voltage: 12 V / 24 V
- Power: 3 watts
- Dimensions: 105 mm x 68 mm
- Connection: cable 2x 0.75 mm<sup>2</sup>, 0.20 m long, gray
- Construction height: 16 mm
- two elongated holes for attachment
- Compatible with almost all LED drawer lights

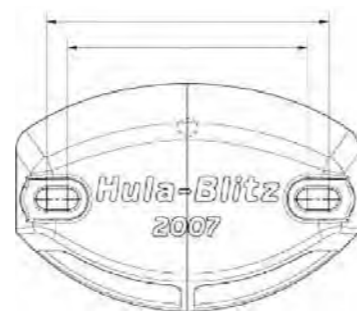

03

**Flashing hazard warning light mini**  
with 4 LEDs

► Item no. 1001-187-1

► Technical specifications

- Operating voltage: 12 V / 24 V
- Power: 4 watts
- Dimensions: 85mm x 85mm x 110mm
- Construction height: 12 mm
- flashes both backwards and to the side
- absolutely flat
- for securing tail lifts



04

**Flashing hazard warning light**  
Hula lightning

► Item no. 1001-184-1

► Technical specifications

- OEM quality
- Including bulbs
- tested according to GGVS
- Die-cast zinc top
- for securing tail lifts

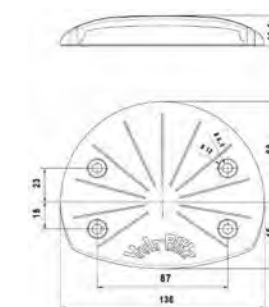

05

**Flashing hazard warning light with 12 LEDs**  
with 12 LEDs, 24V

► Item no. 1001-185-1

► Technical specifications

- waterproof and dustproof diode block
- tested according to GGVS
- Die-cast zinc top
- Connection cable 12 cm
- durable over 10,000 operating hours
- for securing tail lifts

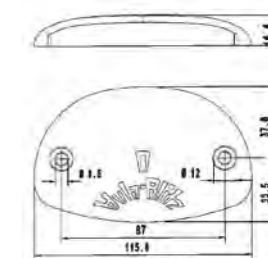





04

**LED work light 2000 Lm**

suitable for 12V and 24V

► Item no. 1004-90-10

► Technical specifications

- Operating voltage: 10 V to 36 V.
- Approval-free with E-mark
- Equipped with 25 high-performance LEDs
- Light intensity: 2000 lumens
- Stray light
- Power consumption: 18 watts
- shockproof PP plastic housing
- low heat generation
- waterproof IP66 IP68
- pre-wired (approx. 2.5 m FLRYY 2x1.5mm<sup>2</sup> supply line)
- Incl. stainless steel universal mounting bracket
- Width lamp body: 101 mm
- Height including foot: 147.5 mm

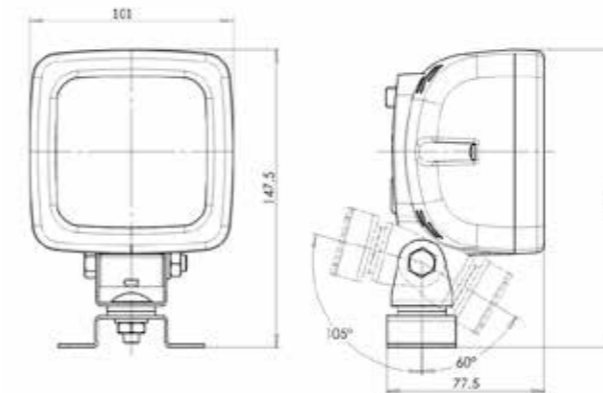
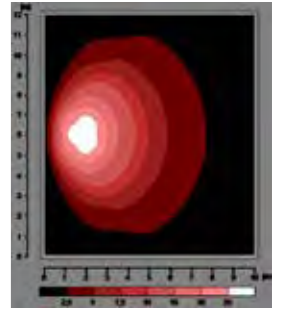



01

**LED work light 2400 Lm**

Operating voltage: 10 V to 36 V.

► Item no. 1004-90-6

► Technical specifications

- Equipped with 12 original Osram high-performance LEDs
- Light intensity: 2400 lumens
- Stray light
- Power consumption: 17 watts
- shockproof PP plastic housing
- low heat generation
- waterproof IP66 IP68
- pre-wired (approx. 2.5 m lead)
- including universal mounting bracket
- Approval-free with E-mark
- for cars and commercial vehicles
- interference-suppressed according to EMC R10
- Height lamp body: 101 mm
- Width lamp body: 101 mm
- Height including foot: 160 mm
- Width including foot: 121 mm
- Base diameter: 121 mm

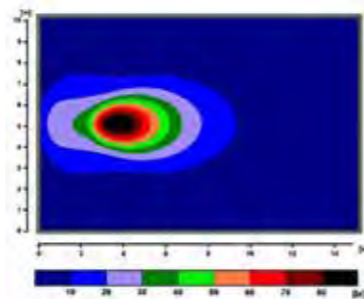

03

**LED work light 3000 Lm**

12V - 70V with Deutsch plug

► Item no. 1004-90-9

► Technical specifications

- also suitable for mounting on forklifts and construction machinery
- IP 66
- 2.5 m lead
- Deutsch connector 2 pin assignment
- 36 watt consumption
- 12V - 70V
- Theoretical luminous flux 3375 lm
- Stainless steel foot to attach
- Weight: 1.05 kg
- Housing: aluminum
- interference-suppressed according to EMC R10
- Luminosity 3000 lm (9 LED)

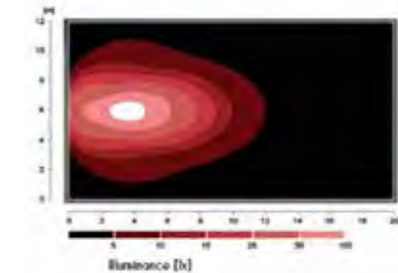

02

**LED work light 2400 Lm with reversing function**

Operating voltage: 10 V to 36 V.

► Item no. 1004-90-7

► Technical specifications

- Approval-free with E-test number and AR marking
- Equipped with 12 original Osram high-performance LEDs
- Light intensity: 2400 lumens
- 12V-24V
- Stray light
- Power consumption: 17 watts
- shockproof PP plastic housing
- low heat generation
- waterproof IP66 IP68
- pre-wired (approx. 2.5 m lead)
- including universal mounting bracket
- interference-suppressed according to EMC R10
- 
- Height lamp body: 101 mm
- Width lamp body: 101 mm
- Height including foot: 160 mm
- Width including foot: 121 mm
- Base diameter: 121 mm

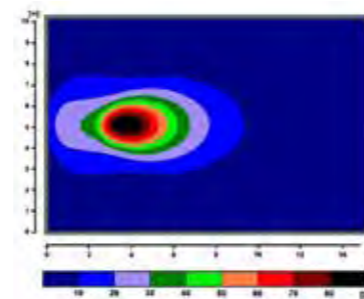

04

**LED work light 5400 Lm**

suitable for 12V and 24V

► Item no. 1004-90-8

► Technical specifications

- Equipped with 12 high-performance LEDs
- Light intensity: approx. 5400 lumens
- Stray light
- Operating voltage: 11.5 V to 33 V.
- pre-wired (approx. 2.5 m lead with 2x1.5mm<sup>2</sup> black / plus white / minus)
- waterproof IP66 / IP68
- Power consumption: 64 watts
- W / H / D: 110 x 159 x 85mm
- shockproof aluminum housing
- low heat generation
- including universal stainless steel mounting bracket
- Approval-free with E-mark
- for cars and commercial vehicles
- interference-suppressed according to EMC R10

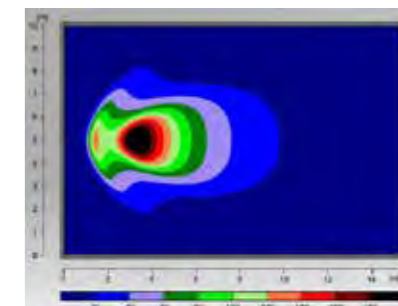



01

**LED rotating beacon**

with magnetic base, orange, 12V / 24V

► Item no. 1006-50-1

► Technical specifications

- insensitive to vibration
- impact and shock resistant housing
- Double flash function
- 3m long spiral cable with cigarette lighter plug
- for mobile variable use
- pre-wired
- Magnetic base
- low heat generation
- Approval-free with E-mark
- equipped with high-performance LED
- ECE R65
- Operating voltage: 12V and 24V
- Power consumption of 14W
- waterproof IP66 / IP68



02

**LED rotating beacon**

screwable, orange, 12V / 24V

► Item no. 1006-50-2

► Technical specifications

- insensitive to vibration
- impact and shock resistant housing
- Double flash function
- screwable, pipe slip-on variant
- for mobile variable use
- pre-wired
- Magnetic base
- low heat generation
- Approval-free with E-mark
- equipped with high-performance LED
- ECE R65
- Operating voltage: 12V and 24V
- Power consumption of 14W
- waterproof IP66 / IP68



03

**LED hazard warning light**

Operating mode: flashing light / continuous light / battery test

► Item no. 1003-230

► Technical specifications

- Power supply: 2 mono cell batteries 1.5 V? (NF article no. 3722-01)
- Operating voltage: 1.8V-3.1V
- Dimensions: 90mm x 208mm x 30mm
- Weight: 480 g
- Approval: on March 12, 2012, the type approval of the lamp was carried out by TÜV Rheinland





01

**Warning marking for containers**  
for containers

► Item no. 1001-181-1

► Technical specifications

- according to § 32 (1) No. 27, 49 (4) No. 4
- Foil type: Type II
- Color: red / white
- Material: plastic film
- Contents: 4 x pointing left, 4 x pointing right
- 705 mm x 141 mm
- Original 3M
- Type II, DIN 67520, color DIN 6171



02

**Warning marking ECE 70 for towing vehicles, on aluminum plate**  
for towing vehicles (class 2)

► Item no. 1001-181-4

► Technical specifications

- Aluminum version
- Foil type: Type II
- Color: yellow / orange
- Standard: ECE 70
- 565mm x 130mm x 1.0mm



03

**Warning marks**  
For trailers and semitrailers

► Technical specifications

- Dimensions: L 570 mm/W 200 mm
- Film type: type II
- Colour: yellow/orange
- E4 007009



Item No.	execution	PU
1001-181-2	with adhesive back	1 pair
1001-181-3	Base material aluminium	1 pair

04

**3M contour marking tape**

According to the regulations UN/ECE R 104

► Technical specifications

- For solid structures
- Adheres to painted, smooth surfaces
- Width: 50 mm, roll length: 50 m



Item No.	Manufacturer	colour	execution
1001-183-06	3M	white	white
1001-183-05	3M	yellow	yellow
1001-183-04	3M	red	Red
1001-183-10	Normfest	white	white
1001-183-09	Normfest	yellow	yellow
1001-183-08	Normfest	red	red



05

**Edge protection film**

45.7 m · 25 mm wide

► Item no. 1001-183-07

► Technical specifications

- Edge protection film, transparent
- self-adhesive and easy to use
- for sealing e.g. vehicle warning markings
- protects against dirt, contamination and damage
- Weather-resistant and long-lasting





02

**Hazard warning flag set**

For tail-lifts

► **Technical specifications**

- Dimensions: L 400 mm/W 250 mm
- According to Section 53b Paragraph 5 of the German Road Traffic Act (StVZO), 5
- Building authority approved
- Film type: type II
- Colour: red/white

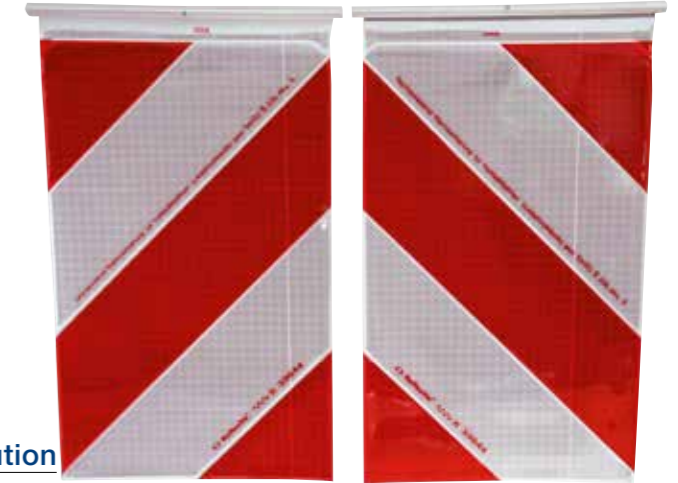

Item No.	execution
1001-182-1	Hazard warning flag (pointing left)
1001-182-2	Hazard warning flag (pointing right)
1001-182-9	Warning flag set with holder
1001-182-3	Aluminium holder

01

**Warning mark**

141 mm wide

► **Technical specifications**

- According to Section 35 of the German Road Traffic Act (StVO)
- Design: Film
- Film type: Type II
- Colour: red/white
- Material: Plastic
- Attachment: self-adhesive
- 3M quality

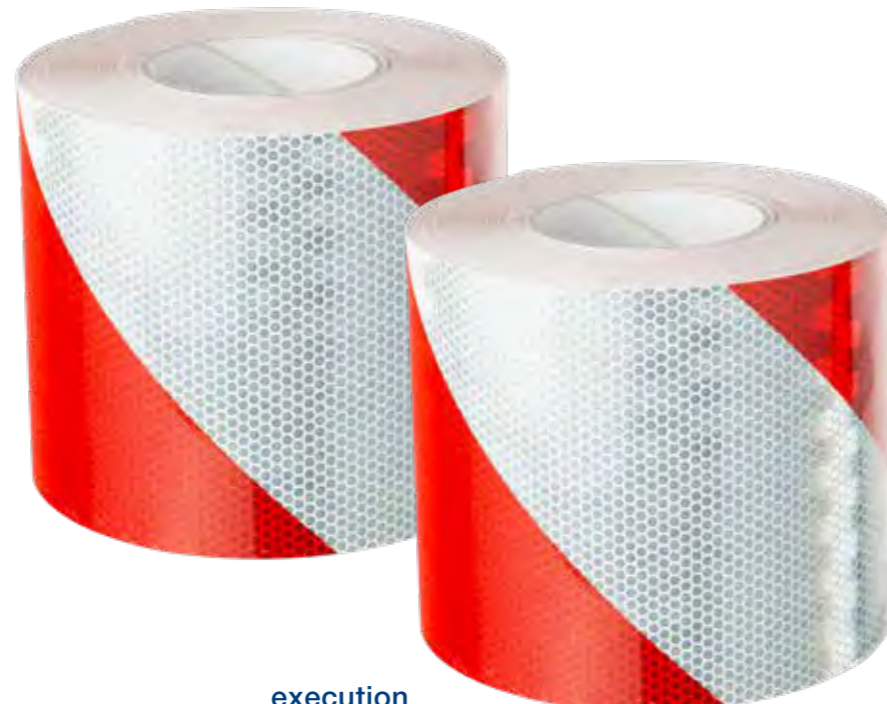

Item No.	execution
1001-183-02	Pointing right 45.7 m
1001-183-03	Pointing left 45.7 m
1001-183-0	Hazard warning mark set 144 mm x 9 m Contents: 1x9 m pointing left, 1x9 m pointing right

03

**Parking warning sign**

foldable, 285 x 285 mm

► **Technical specifications**

- Parking warning sign according to StVZO (Road Traffic Licensing Regulations) § 22a STV20 section 1 number 9
- 8-prism rear reflector
- Film type: Type III
- Colour: red/white
- Material: aluminium



Item No.	execution
1001-180-1	Front
1001-180-3	Rear



01  
**Blind spot sticker**  
 Dimensions: 25 x 17 cm



Item No.	execution	PU
7410-004-022		1
7410-004-023	truck	1

02  
**ADR hazard sign GGVS / ADR approved**  
 GGVS / ADR approved, foldable



- ▶ Item no. 1001-181-5
- ▶ Technical specifications
  - Color orange
  - Foil type: Type I.
  - Dimensions 400 mm x 300 mm
  - with edge protection and hole on top
  - Material: sheet steel

02  
**A hazard sign Waste hazard sign**  
 Waste hazard sign



- ▶ Item no. 1001-181-6
- ▶ Technical specifications
  - Color white
  - Foil type: Type I.
  - foldable
  - with edge protection



04  
**Thermal paper rolls**  
 for digital tachographs

- ▶ Item no. 1003-1-190
- ▶ Technical specifications
  - Tested by the Federal Motor Vehicle Office E1-190
  - PU = 3 rolls of 10 m
  - Width: 57mm
  - Paper weight: 60 g
  - top-coated (front and back coated for optimal protection)



05  
**Speed-time chart**  
 1 pack = 100 discs

Item No.	execution	PU
1003-125-01	Universal, 125 km/h	100
1003-140-01	Universal, 140 km/h	100
1003-125-05	Universal, 180 km/h	100





01

**Lashing strap**

8m x 50 mm, 5t, DIN EN 12195-2 tested STF 300 daN

► Item no. 1002-55-355

► Technical specifications

- Width: 50mm
- Length: 8 m (7.5 m belt / 0.5 m ratchet)
- Pre-tensioning force: STF 300 daN
- Pulling force: 2,500 daN
- Hand force: SHF 50 daN
- tested according to DIN EN 12195-2
- Temperature range: -40 ° C to 100 ° C
- Elongation: 5%
- abrasion-resistant
- Claw hook and pressure ratchet
- with GS mark
- highly reinforced polyester fabric



02

**Long lever tension belt**

8m x 50mm, DIN EN 12195-2 tested STF 600 daN

► Item no. 1002-55-358

► Technical specifications

- Width: 50mm
- Length: 8 meters (7.5 meters belt, 0.5 meters ratchet) with claw hook
- Pre-tensioning force: STF 500 daN
- Pulling force: 2,500 daN
- Hand force: SHF 50 daN
- tested according to DIN EN 12195-2
- Temperature range: -40 ° C to 100 ° C
- Elongation 5%
- abrasion-resistant
- Hook and ergo pulling ratchet with hand lever lock
- with GS mark
- highly reinforced polyester fabric



03

**Loose end for tension belt**

7.5 m with claw hook

► Item no. 1002-55-357

► Technical specifications

- Width: 50mm
- Length: 7.5 m strap with claw hook
- Pre-tensioning force: SHF 50 daN
- Pulling force: 2,500 daN
- tested according to DIN EN 12195-2
- Temperature range: -40 ° C to 100 ° C
- Elongation 5%
- abrasion-resistant
- with hook
- with GS mark
- highly reinforced polyester fabric





01

**Anti-slip mat**

Regupol 7210 LS

► Item no. 1002-56

► Technical specifications

- Dimensions: 5 m long x 25 cm wide
- Thickness: 8mm
- Resistance: UV, sodium chloride, weak acids and alkalis
- Cleaning: shake out, vacuum off, wash off, if necessary treat with a high pressure cleaner
- Color: black with dark green, light green and yellow color particles
- reusable



02

**Edge protection for tension belts**

Protection against sharp-edged cargo

► Item no. 1002-55-2

► Technical specifications

- Dimensions: 100 mm x 100 mm
- Can be used for 90 ° angles
- slotted, 45 ° beveled for easy threading of the tension belt
- Protects the belt from sharp, rough edges
- The tape guide and side tabs prevent the corner protectors from slipping or falling off
- better distribution of preload forces



03

**Tarpaulin repair plaster**

with extreme adhesive power

► Technical specifications

- Highly tear-resistant PVC fabric (OEM tarpaulin material)
- extreme adhesive strength, self-adhesive on one side
- Adhesive: weather and aging resistant special adhesive
- Tear strength: 2,500 N / 5 cm according to DIN EN ISO 1421 / VI
- Further tear strength: 270 N (according to DIN 53363)
- Weight: 650 g / m
- Temperature resistance: -30 ° C to 70 ° C
- Best adhesive strength at temperatures of: 10 ° C to 25 ° C
- Weather-resistant and long-lasting
- UV-resistant and resistant to washing brushes

Item No.	Width (mm)	Length [m]	colour	PU
1001-190-1	100	5	white	1
1001-190-2	100	5	silver	1



04

**Pressure roller**

for tarpaulin welding

► Item no. 1010-100-1

► Technical specifications

- Width: 45mm
- Diameter: 39mm

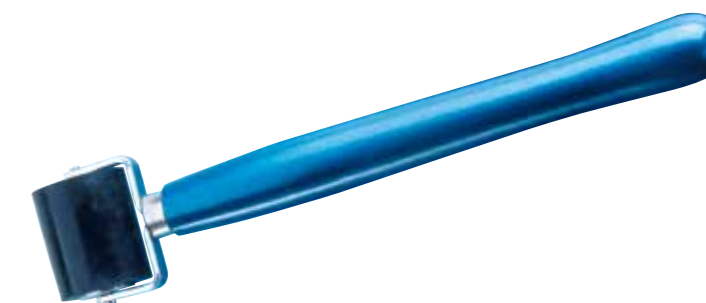

01

**Tarpaulin hook**

For spin lock, reinforced inside with rounded edges, polyamide 6

Item No.	Length [mm]	Hole spacing	Hole Ø	PU
1010-30-01	66	20 mm	3 mm	100



02

**Flat hook**

galvanized

Item No.	Length [mm]	Hole spacing	Hole Ø	PU
1010-30-11	74	20 mm	3 mm	100



03

**Three-hole tarpaulin hook, plastic**

Plastic, gray

Item No.	Width (mm)	Length [mm]	Hole Ø	PU
1010-30-21	40	45	3 mm	100



04

**S-hook**

galvanized

Item No.	Width (mm)	Length [mm]	PU
1010-31-030	3	30	100
1010-31-042	4,2	45	100



05

**Hollow rivet double calott**

Double Calott galvanized

Item No.	Ø mm	Length [mm]	PU
1010-41-21	13	12	100



06

**Rubber stoppers**

adjustable, 280 mm x 40 mm



Item No.	Width (mm)	Length [mm]	Ø mm	PU
1010-70-500	40	280	8	25

07

**Rubber tension ring**

Ø 8 mm, black



Item No.	Length [mm]	Ø mm	PU
1010-70-200	200	8	50
1010-70-250	250	8	50
1010-70-400	400	8	50

08

**Buckle strap**

Width 20 mm

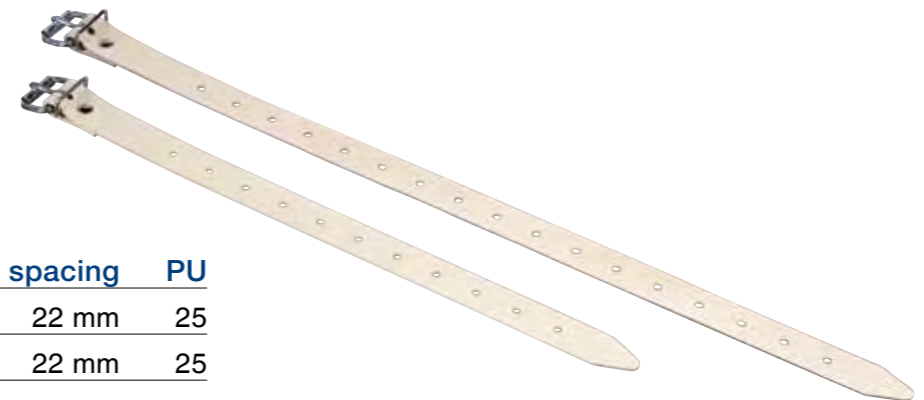

Item No.	Length [mm]	Hole spacing	PU
1010-60-350	350	22 mm	25
1010-60-500	500	22 mm	25



01

**Expander rope**

100 m roll

► **Technical specifications**

- very good UV light resistance
- very good abrasion resistance
- incorruptible
- constant colors
- long lifetime
- Composition of the rope:
- Main core: multi-wire core made of latex
- Outer jacket: PE polyethylene monofiber
- Force daN to 25% elongation of the useful length 3.8
- Force daN to 50% elongation of the effective length 5.0
- Force daN to 75% elongation of the effective length 6.2
- Force daN to 100% elongation of the effective length 7.4
- Breaking strength in daN 73
- Elongation in% of the effective length at the breaking point 270

Item No.	Ø mm	Length [m]
1010-536-100	8	100
1010-537-100	10	100



02

**Tarpaulin rope**

Ø 8 mm

► **Technical specifications**

- 100 mtr.
- Plastic tarpaulin rope, cadmium-free
- Sisal translucent

Item No.	Ø mm	Length [m]
1010-535-100	8	100



03

**Twist clamp**

for expander and tarp rope

Item No.	Ø mm	PU
1010-032-08	8	50
1010-032-10	10	50



04

**Rope end closure**

with simplex hook, galvanised

Item No.	Ø mm	PU
1010-50-008	8	50
1010-50-010	10	50





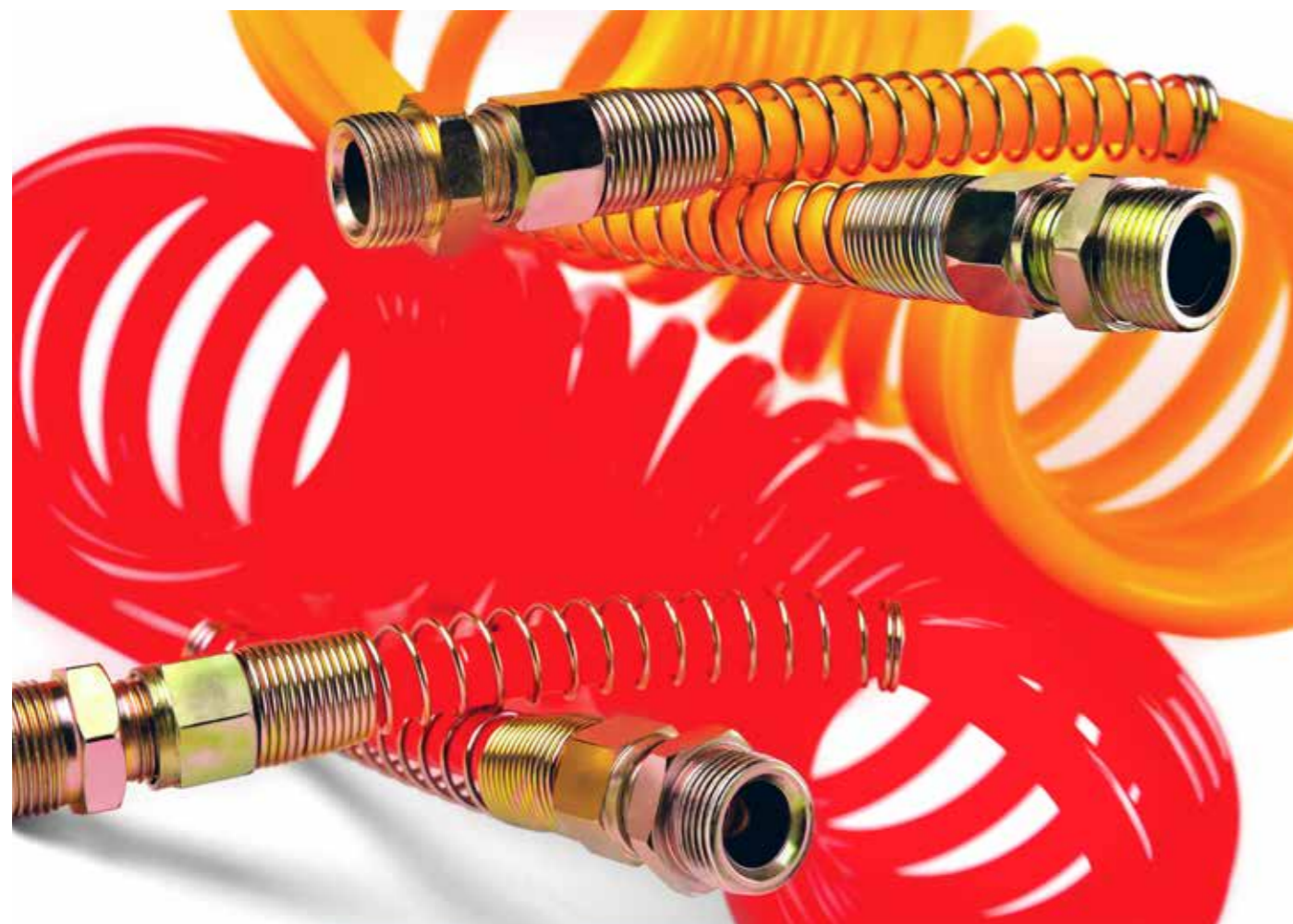

01  
**Extension socket set**  
set

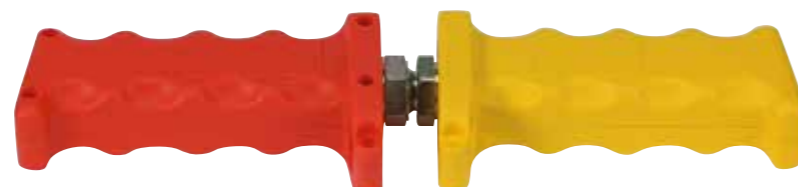

- ▶ Item no. 1005-10-003
- ▶ Technical specifications  
- for air coil M16

02  
**Threaded piece**  
with supply lines

Item No.	execution	PU
1005-41-01	Short, M16	1
1005-41-02	M22 short	1
1005-41-03	M16 long	1
1005-41-04	M18 long	1



03  
**NF PU spiral**  
Hard wearing and flexible

- ▶ Technical specifications
- 21 windings (tightly wound diameter 80 mm)
- Steel anti-kink spring
- Max. working length 4.5 m
- Temperature range -40°C to +95°C
- Threaded piece M16 on both ends

Item No.	colour
1005-10-005	red
1005-10-006	yellow
1005-10-007	for 1001-179-6

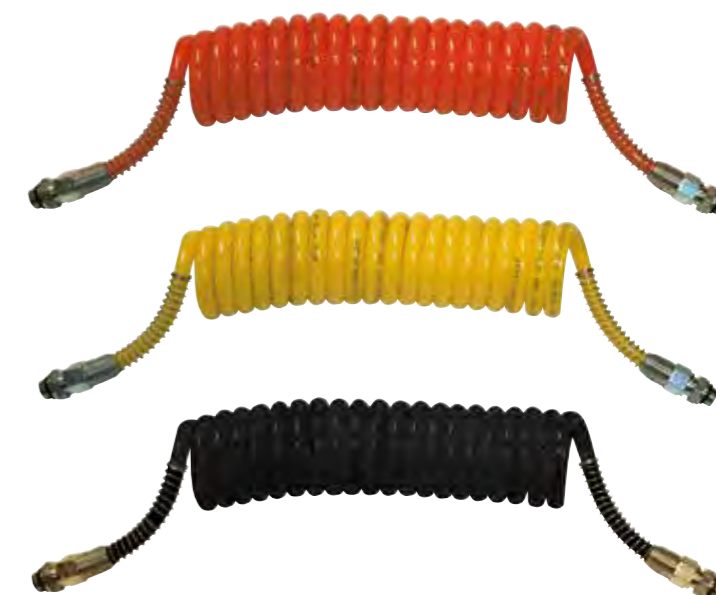

04  
**PU coil**  
21 windings, hard-wearing and flexible

- ▶ Technical specifications
- Max. working length: 4.5 m
- With threaded end piece M16
- Temperature range -40°C to +95°C

Item No.	colour
1005-10-001	red
1005-10-002	yellow

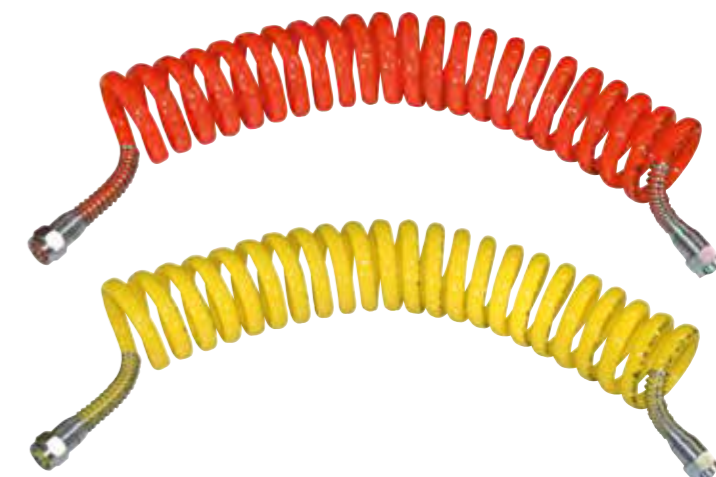

05  
**Blow gun including T-piece quick coupling**  
including T-piece quick coupling

- ▶ Item no. 1002-500
- ▶ Technical specifications
- for cleaning the interior of the truck
- Gun length: 120 mm
- PU spiral hose length: 5 m
- Maximum pressure: 13 kg / cm<sup>2</sup>
- including T-piece quick coupling





01

**Coupling head**

Standard, without valve, e.g. for trailers

Item No.	execution	colour	PU
1005-50-01	M16	yellow	1
1005-50-03	M22	yellow	1
1005-50-02	M16	red	1
1005-50-04	M22	red	1
1005-52-03	Spare gasket	black	25



03

**Coupling head**

for semi-trailer, with line filter

Item No.	execution	colour	PU
1005-53-01	M16	red	1
1005-53-02	M16	yellow	1
1005-53-03		yellow	1



02

**Coupling head**

Automatic, with check valve

Item No.	execution	colour	PU
1005-51-01	M16	yellow	1
1005-51-03	M22	yellow	1
1005-51-02	M16	red	1
1005-51-04	M22	red	1



04

**Coupling head**

for drawbar trailers, with line filter

Item No.	execution	colour	PU
1005-53-04	M16	red	1
1005-53-05	M16	yellow	1
1005-53-06	M16	yellow	1



01  
**Straight-line connector**  
made of brass

Item No.	execution	PU
1002-16-06	6 mm	5
1002-16-08	8 mm	5
1002-16-09	9 mm	5
1002-16-010	10 mm	1
1002-16-011	11 mm	5
1002-16-012	12 mm	1
1002-16-015	15 mm	5



02  
**T-connector**  
Brass

Item No.	execution	PU
1002-14-06	6 mm	1
1002-14-08	8 mm	1



03  
**Reducer coupling**  
Brass

Item No.	execution	PU
1002-8-6	6-8 mm	1
1002-10-6	6-10 mm	1
1002-10-8	8-10 mm	1
1002-12-8	8-12 mm	1
1002-12-10	10-12 mm	1



04  
**Straight-line connector**  
made of plastic

Item No.	execution	PU
1002-06-04	4 mm	10
1002-06-05	5 mm	10
1002-06-06	6 mm	5
1002-06-08	8 mm	5
1002-06-10	10 mm	5
1002-06-12	12 mm	5



05  
**T-joint**  
Plastic

Item No.	execution	PU
1002-04-04	4 mm	5
1002-04-06	6 mm	5
1002-04-08	8 mm	5



06  
**Straight connector assortment**  
Brass, plastic

► Item no. 1957-100-1

► Contents: 40 parts

- 5 x plastic straight connector 4mm (item no. 1002-06-04)
- 5 x plastic straight connector 5mm (item no. 1002-06-05)
- 5 x plastic straight connector 6mm (item no. 1002-06-06)
- 5 x plastic straight connectors 8mm (item no. 1002-06-08)
- 5 x brass straight connector 10mm (Item No. 1002-16-010)
- 5 x brass straight connectors 12mm (item no. 1002-16-012)
- 5 x brass straight connector 6mm (item no. 1002-16-06)
- 5 x brass straight connectors 8mm (item no. 1002-16-08)



01

**Pipe clamps**  
rubberized

- Technical specifications
- completely galvanized
- RSGU
- rubberized



Item No.	Pipe Ø	Bandwidth	Hole Ø	PU
5542-6-12	6 mm	12 mm	5,3 mm	50
5542-6-15	6 mm	15 mm	6,4 mm	50
5542-8-12	8 mm	12 mm	5,3 mm	50
5542-8-15	8 mm	15 mm	6,4 mm	50
5542-8-20	8 mm	20 mm	8,4 mm	50
5542-9-12	9 mm	12 mm	5,3 mm	50
5542-10-12	10 mm	12 mm	5,3 mm	50
5542-10-15	10 mm	15 mm	6,4 mm	50
5542-12-12	12 mm	12 mm	5,3 mm	50
5542-12-15	12 mm	15 mm	6,4 mm	50
5542-15-12	15 mm	12 mm	5,3 mm	25
5542-15-15	15 mm	15 mm	6,4 mm	25
5542-15-20	15 mm	20 mm	8,4 mm	25
5542-18-15	18 mm	15 mm	6,4 mm	25
5542-20-15	20 mm	15 mm	6,4 mm	25
5542-20-20	20 mm	20 mm	8,4 mm	25
5542-25-12	25 mm	12 mm	5,3 mm	25
5542-25-15	25 mm	15 mm	6,4 mm	25
5542-25-20	25 mm	20 mm	8,4 mm	10
5542-30-15	30 mm	15 mm	6,4 mm	10
5542-30-20	30 mm	20 mm	8,4 mm	10
5542-35-15	35 mm	15 mm	6,4 mm	10
5542-40-20	40 mm	20 mm	8,4 mm	10
5542-50-15	50 mm	15 mm	6,4 mm	10



02

**Polyamide pipes**

Pressure-resistant up to 15 bar, 25 meter collar, DIN 73378



Item No.	Ø mm	Wall thickness mm
1002-54-06	6	1,0
1002-54-08	8	1,0
1002-54-10	10	1,0
1002-54-12	12	1,5
1002-54-15	15	1,5

03

**Cutting pliers for polyamide pipes**

- Item no. 1002-08-100
- Item no. 1002-08-111 | Replacement blades, 1 pair

- Technical specifications:
- with interchangeable blades
- with protective cover
- Aluminum body, total length 185 mm
- Blade made of 65 Mn steel





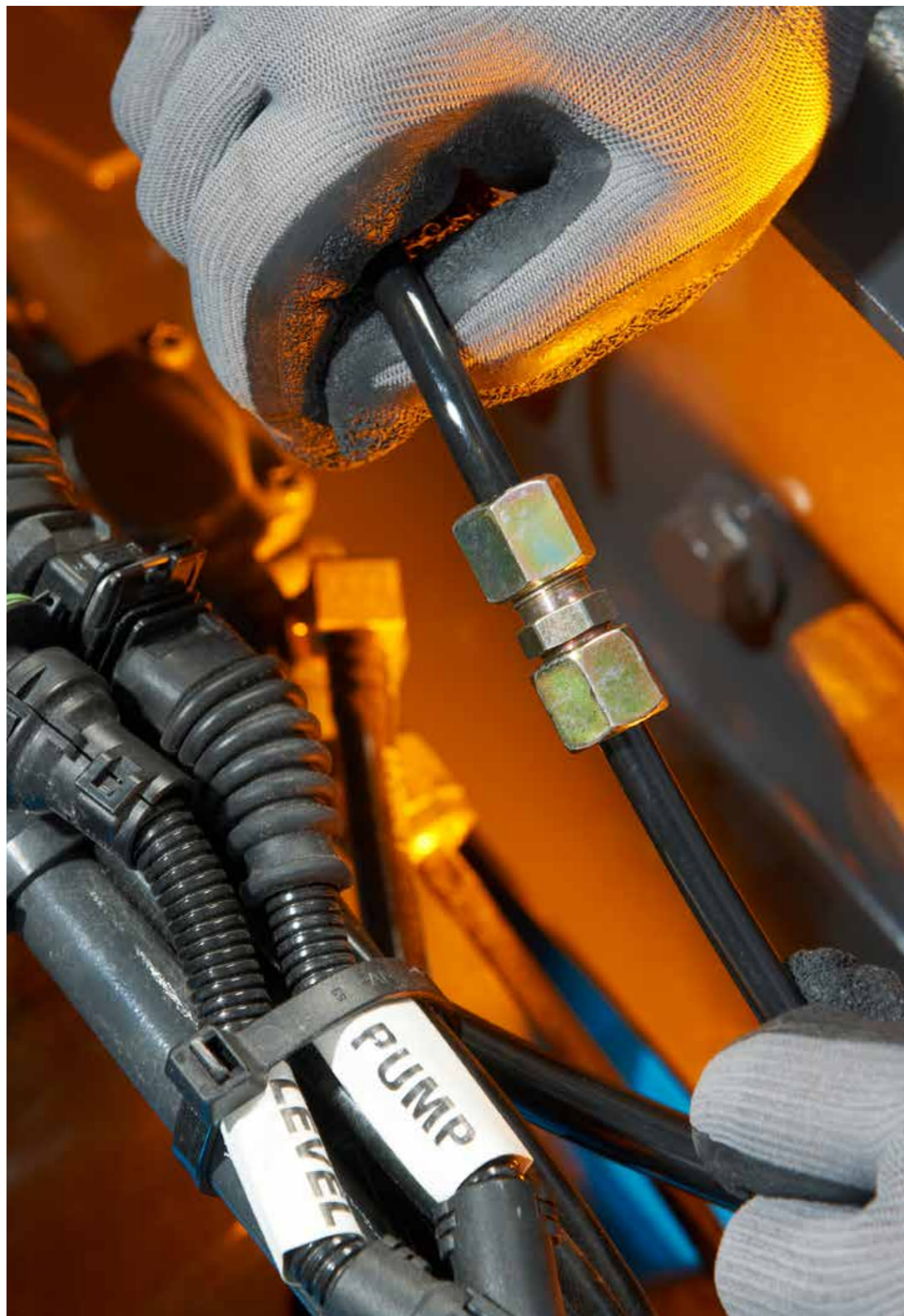

**01**  
**Threaded screw connections**

Item No.	pipe	PU
1002-54-064	6 x 1,0	1
1002-54-084	8 x 1,0	1
1002-54-104	10 x 1,0	1
1002-54-124	12 x 1,5	1
1002-54-154	15 x 1,5	1



**02**  
**Cutting rings**

Item No.	pipe	PU
1002-54-062	6 x 1,0	1
1002-54-082	8 x 1,0	1
1002-54-102	10 x 1,0	1
1002-54-122	12 x 1,5	1
1002-54-152	15 x 1,5	1



**03**  
**Nuts**

Item No.	pipe	PU
1002-54-063	6 x 1,0	1
1002-54-083	8 x 1,0	1
1002-54-103	10 x 1,0	1
1002-54-123	12 x 1,5	1
1002-54-153	15 x 1,5	1



**04**  
**Support sleeves**

Item No.	pipe	PU
1002-54-061	6 x 1,0	1
1002-54-081	8 x 1,0	1
1002-54-101	10 x 1,0	1
1002-54-121	12 x 1,5	1
1002-54-151	15 x 1,5	1



**05**  
**Brake rings**  
Truck air brake, brake screw connection

Item No.	Execution ring	Design sealing ring	PU
6464-12-16	12 x 16	10 x 14	1
6464-14-18	14 x 18	12 x 17	1
6464-16-22	16 x 22	15 x 19	1
6464-18-22	18 x 22	16 x 20	1
6464-22-27	22 x 27	20 x 24	1







01

**Assortment of fittings**

Contents: 123 parts

► Item no. 1957-54-016

► Content:

- 10 x cutting ring 6 (Item No. 1002-54-062)
- 10 x cutting ring 8 (Item No. 1002-54-082)
- 8 x cutting ring 10 (item no. 1002-54-102)
- 8 x cutting ring 12 (Item No. 1002-54-122)
- 5 x cutting ring 15 (Item No. 1002-54-152)
- 10 x union nut 6 (item no. 1002-54-063)
- 10 x union nut 8 (item no. 1002-54-083)
- 8 x union nut 10 (item no. 1002-54-103)
- 8 x union nut 12 (item no. 1002-54-123)
- 5 x union nut 15 (item no. 1002-54-153)
- 10 x support sleeves 6 x 1 (item no. 1002-54-061)
- 10 x support sleeves 8 x 1 (item no. 1002-54-081)
- 8 x support sleeves 10 x 1 (item no. 1002-54-101)
- 8 x support sleeves 12 x 1 (item no. 1002-54-121)
- 5 x support sleeve 15 x 1.5 (item no. 1002-54-151)

02

**Lubricator nipple**

- DIN 71412 A, H1
- galvanised
- hardened
- surface chromated



03

**Lubricator nipple**

DIN 71412, H 2



04

**Lubricator nipple**

DIN 71412, H 3



Item No.	execution	PU	Item No.	execution	PU	Item No.	execution	PU
6986-40	M6 x 1	50	6986-50	M6 x 1	50	6986-60	M6 x 1	50
6986-41	M8 X 1	50	6986-51	M8 X 1	50	6986-61	M8 X 1	50
6986-42	M10 x 1	50	6986-52	M10 x 1	50	6986-62	M10 x 1	50

05

**Heavy duty hose clamps, pivot bolt clamps**

► Technical specifications

- Hinge and lock made of W2 / DIN 1.4016
- Galvanized steel screw
- very high breaking torque
- very high belt tension
- Special screw with integrated spacer tube and hexagon socket
- reinforced tape loops
- mechanical suspension without welding points and contact corrosion
- Bridge with hose protection
- Robust tape with rounded edges prevents injuries and hose damage
- Hollow bolts reduce the tensile force on the screw and mechanical lock



Item No.	Clamping range	Bandwidth	PU	Item No.	Clamping range	Bandwidth	PU
5543-19-21	19-21 mm	18 mm	10	5543-55-59	55-59 mm	20 mm	10
5543-23-25	23-25 mm	18 mm	10	5543-63-68	63-68 mm	20 mm	10
5543-25-27	25-27 mm	18 mm	10	5543-73-79	73-79 mm	25 mm	10
5543-29-31	29-31 mm	18 mm	10	5543-85-91	85-91 mm	25 mm	5
5543-34-37	34-37 mm	18 mm	10	5543-97-104	97-104 mm	25 mm	5
5543-40-43	40-43 mm	18 mm	10	5543-112-121	112-121 mm	25 mm	5
5543-47-51	47-51 mm	20 mm	10	5543-140-150	140-150 mm	30 mm	5
				5543-150-162	150-162 mm	30 mm	5

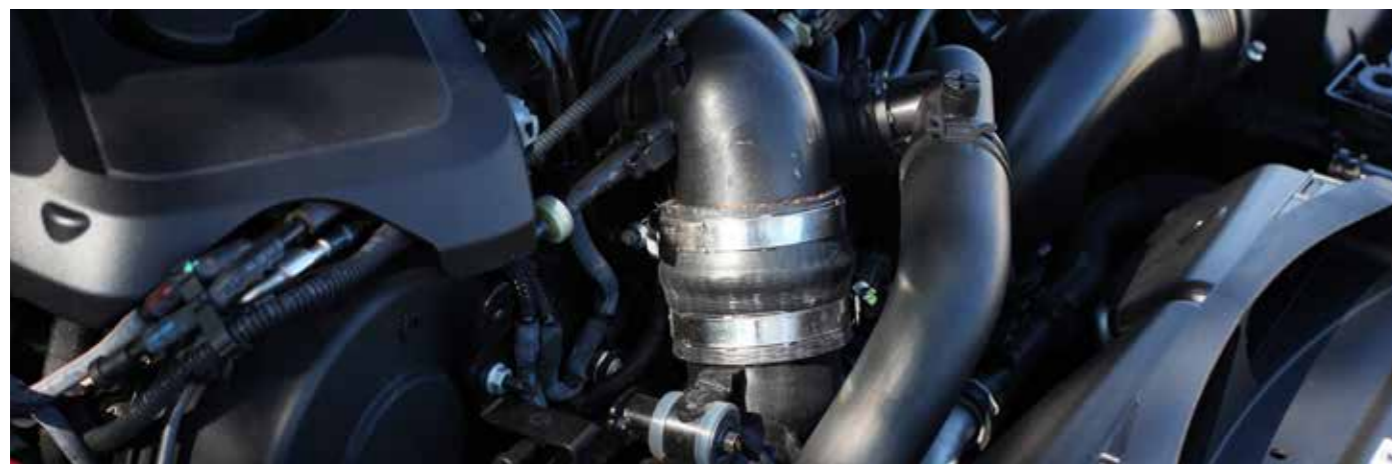

**01**  
**Hose clamps with worm thread**

► **Technical specifications**

- Strap and case: stainless steel 1.4016
- Screw: steel, galvanized, band width 9 mm
- Wrench size 7 mm



Item No.	Clamping range	PU
5539-008-12	8 - 12 mm	50
5539-008-16	8 - 16 mm	50
5539-012-20	12 - 20 mm	50
5539-016-25	16 - 25 mm	50
5539-020-32	20 - 32 mm	50
5539-025-40	25 - 40 mm	50
5539-032-50	32 - 50 mm	50
5539-040-60	40 - 60 mm	25
5539-050-70	50 - 70 mm	25
5539-060-80	60 - 80 mm	25
5539-070-90	70 - 90 mm	25
5539-080-100	80 - 100 mm	25
5539-090-110	90 - 110 mm	25
5539-100-120	100 - 120 mm	25
5539-110-130	110 - 130 mm	25
5539-120-140	120 - 140 mm	25
5539-130-150	130 - 150 mm	10
5539-140-160	140 - 160 mm	10
5539-150-170	150 - 170 mm	10
5539-160-180	160 - 180 mm	10

**02**  
**Hose clamp display**

► **Item no. 5539-077-777**

► **Technical specifications**

- Band width 9 mm
- embossed band inside
- Band and housing made of stainless steel 1.4016
- Corrosion resistance in the salt spray test at least 72 hours
- Trapezoidal thread (smooth inside of the belt)
- Screw with cross recess (SW 7), galvanized steel

- **Applications:**

- Cooling water connections
- Pressureless and pressurized fuel lines and vents
- Oil lines
- Connections of pipes in the sanitary area
- Connections of lines in mechanical engineering
- Lines in the household appliance industry
- Hose connections in the commercial vehicle industry

- 
- 20 x hose clamps with worm thread 8-16 (item no. 5539-008-16)
- 20 x hose clamps with worm thread 12-22 (item no. 5539-012-20)
- 10 x hose clamps with worm thread 16-27 (item no. 5539-016-25)
- 10 x hose clamps with worm thread 20-32 (item no. 5539-020-32)
- 10 x hose clamps with worm thread 25-40 (item no. 5539-025-40)
- 10 x hose clamps with worm thread 32-50 (item no. 5539-032-50)
- 10 x hose clamps with 40-60 worm thread (item no. 5539-040-60)
- 10 x hose clamps with worm thread 50-70 (item no. 5539-050-70)
- 10 x hose clamps with worm thread 60-80 (item no. 5539-060-80)
- 10 x hose clamps with worm thread 70-90 (item no. 5539-070-90)
- 1 x 426-7; hexagonal socket wrench (item no. 5539-85)
- 1 x perforated plate 500x450 MM (Item No. 7100-000-1)
- 12 x tool holder angled 150mm (Item No. 7100-000-3)
- 1 x tool clamp small 19mm (Item No. 7100-000-305)
- 2 x self-adhesive label strips 430mm (Item No. 7100-000-5)





01

**ABA hose clamps**

► **Technical specifications**

- 50% greater tensile load compared to standard worm-drive hose clamps
- Weld- and rivet-free casing made from one piece
- Embossed band with high edges prevents damage to the hose wall
- Short casing saddle guarantees optimal positive locking
- Hexagon socket screw with slot



Item No.	Clamping range	Bandwidth	PU
5538-008-012	8 - 12 mm	9 mm	50
5538-010-016	10 - 16 mm	9 mm	50
5538-012-020	12 - 20 mm	9 mm	50
5538-016-025	16 - 25 mm	9 mm	50
5538-020-032	20 - 32 mm	9 mm	50
5538-025-040	25 - 40 mm	9 mm	50
5538-032-050	32 - 50 mm	9 mm	50

02

**Hose clamps made of stainless steel with worm thread and wave spring**

► **Technical specifications**

- integrated spring insert
- completely made of stainless steel
- Band width 12mm
- embossed band inside
- Drive screw hex. Wrench size 7mm with slot
- compensates for diameter fluctuations
- Automatic retensioning effect when the hose relaxes
- Increased sealing reliability over a wide temperature range
- Material: W4
- Corrosion resistance in the salt spray test: at least 240 hours



Item No.	Clamping range	Bandwidth	PU
5539-216-27	16 - 27 mm	12 mm	25
5539-220-32	20 - 32 mm	12 mm	25
5539-225-40	25 - 40 mm	12 mm	25
5539-230-45	30 - 45 mm	12 mm	25
5539-235-50	35 - 50 mm	12 mm	25
5539-240-60	40 - 60 mm	12 mm	25
5539-250-70	50 - 70 mm	12 mm	25
5539-260-80	60 - 80 mm	12 mm	25

03

**Hose clamps ABA mini**

► **Technical specifications**

- for small diameters and thin-walled hoses
- pre-galvanized clamp
- Screw with combination slot
- Use of various installation tools
- rounded edges
- The strap is placed under the hose, profiled for additional tension
- Hexagonal head that can be tightened flexibly
- the nut cannot be lost even if the screw is removed



Item No.	Clamping range	PU
5546-9-7	7-13 mm	50
5546-9-8	8-13 mm	50
5546-9-9	9-13 mm	50
5546-9-10	10-13 mm	50
5546-9-11	11-16 mm	50
5546-9-12	12-16 mm	50
5546-9-13	13-16 mm	50
5546-9-14	14-16 mm	50
5546-9-15	15-20 mm	50
5546-9-16	16-20 mm	50
5546-9-17	17-20 mm	50

04

**Hose clamps Norma**

► **Technical specifications**

- Band width 9 mm
- all parts are completely galvanized steel
- Corrosion resistance in the salt spray test at least 72 hours
- with cylinder head screw
- manufactured according to DIN 3017



Item No.	Ø range	Bandwidth	PU
5540-18-9	18 mm	9 mm	50
5540-20-9	20 mm	9 mm	50
5540-22-9	22 mm	9 mm	50
5540-18-12	18 mm	12 mm	50
5540-19-12	19 mm	12 mm	50

01

**Fuel hose clamps**

► **Technical specifications**

- quick, easy and safe assembly
- Good edge rounding through vibratory grinding technology prevents damage to the item to be set
- Setting control through visible reshaping of the clamp ear
- The flanged insert ring bridges the gap in the ear of the clamp ear, thus ensuring all-round binding
- material
- Clamp: stainless steel, material no. 1.4301 / UNS S30400
- Insert ring: stainless steel, material no. 1.4310 / UNS S30100



Item No.	Clamping range	Bandwidth	PU
5541-070	5,6 - 6,5 mm	6,4 mm	100
5541-087	7,0 - 8,2 mm	6,4 mm	100
5541-095	7,5 - 9,0 mm	7,4 mm	100
5541-010-5	8,5 - 10,0 mm	7,4 mm	100
5541-011-3	9,1 - 10,8 mm	7,4 mm	100
5541-012-3	9,8 - 11,8 mm	7,4 mm	100
5541-012-8	10,3 - 12,3 mm	7,4 mm	100
5541-013-3	10,6 - 12,6 mm	8,2 mm	100
5541-013-8	11,1 - 13,1 mm	8,2 mm	100
5541-014-5	11,8 - 13,8 mm	8,2 mm	100
5541-015-0	12,3 - 14,8 mm	8,2 mm	50
5541-015-5	12,8 - 14,8 mm	8,2 mm	50
5541-016-0	13,1 - 15,3 mm	8,2 mm	50
5541-016-8	13,9 - 16,1 mm	8,2 mm	50
5541-017-5	14,6 - 16,8 mm	8,2 mm	50
5541-019-5	16,5 - 18,8 mm	8,2 mm	100
5541-021-0	18,0 - 20,3 mm	8,2 mm	50
5541-025-5	22,0 - 24,8 mm	8,2 mm	50

03

**Breeze clamps**

► **Technical specifications**

- Strap and case: stainless steel A2
- Screw: steel, zinc-plated, slotted hexagon screw
- Screw thread, belt width 14.3 mm
- Width across flats 8 mm



Item No.	Clamping range	PU
5547-11-20	10 - 20 mm	25
5547-16-25	16 - 25 mm	25
5547-20-32	20 - 32 mm	25
5547-25-40	25 - 40 mm	25
5547-32-50	35 - 50 mm	25
5547-40-60	40 - 60 mm	25
5547-50-70	50 - 70 mm	25
5547-60-80	60 - 80 mm	25
5547-70-90	70 - 90 mm	25
5547-80-100	80 - 100 mm	10
5547-90-110	90 - 110 mm	10
5547-100-120	100 - 120 mm	10
5547-110-130	110 - 130 mm	10
5547-120-140	120 - 140 mm	10

02

**Hose clamps mini**

► **Technical specifications**

- embossed tape
- with slotted head screw
- Band width 5mm



Item No.	Clamping range	PU
5541-7-11	7 - 11 mm	50
5541-9-16	9 - 14 mm	50
5541-10-19	10 - 19 mm	50



01

**7-pole helix**

7-pin

► Item no. 3555-320-43

► Technical specifications

- Working length: 3.0 m
- Material: PUR
- Restoring force corresponds to the OEM regulations
- with waterproof connectors
- Type S - 3731
- 6 sockets, 1 pin
- 7-pin
- 24 V



02

**7-pole helix**

7-pin

► Item no. 3555-320-42

► Technical specifications

- Working length: 3.0 m
- Material: PUR
- Restoring force corresponds to the OEM regulations
- with waterproof connectors
- Type N
- little twisted
- 7-pin
- ISO 1185
- 24 V



03

**EBS spiral cable 7-pole**

7-pin

► Item no. 3555-320-45

► Technical specifications

- Working length: 3.5 m
- Material: PUR
- Restoring force corresponds to the OEM regulations
- little twisted
- 7-pin
- 24V



04

**15-pole helix**

15-pin

► Item no. 3555-320-50

► Technical specifications

- Working length: 3.5 m
- with clamp connection
- Material: PUR
- Restoring force corresponds to the OEM regulations
- little twisted
- 15-pin
- 24 V
- 



05

**Adapter spiral cable 15-pin to 2 x 7-pin**

15-pin to 2 x 7-pin

► Item no. 3555-320-53

► Technical specifications

- for the power supply of new? commercial vehicle tractors on older trailers
- 13 poles occupied in accordance with standards
- encapsulated plugs type „N“ and type „S“
- Working length: 3.5 m
- Material: PUR
- Restoring force corresponds to the OEM regulations
- little twisted
- 24 V



06

**Adapter spiral cable 15-pin to 2 x 7-pin**

15-pin to 2 x 7-pin

► Item no. 3555-320-51

► Technical specifications

- 13-pin assigned
- Working length: 3.5 m
- Type N / S
- Material: PUR
- Restoring force corresponds to the OEM regulations
- little twisted
- 15- to 7-pin
- 24 V



01

**EBS socket 7-pin**

7-pin

▶ Item no. 3555-310-7

▶ Technical specifications

- with screw contacts
- GGVS / ADR tested
- 7-pin
- 24 V



04

**3-pin socket**

3 pole

▶ Item no. 3555-310-60

▶ Technical specifications

- with screw contacts
- Type S
- Load capacity: 20 A to 24 V.
- plastic
- ISO 1185 K pin
- 3 pole
- 24 V



02

**7-pin socket**

7-pin

▶ Item no. 3555-305-286

▶ Technical specifications

- with screw contacts
- Rubber seal in the cover
- Type S
- Load capacity: 20 A to 24 V.
- ISO 3731 K socket
- 7-pin
- 24 V



05

**15-pin sockets**

15-pin

▶ Item no. 3555-310-15

▶ Technical specifications

- with screw contacts
- GGVS / ADR tested
- 15-pin
- 24 V



01

**7-pin socket**

7-pin

▶ Item no. 3555-305-287

▶ Technical specifications

- with screw contacts
- Rubber seal in the cover
- Type N
- Load capacity: 20 A to 24 V.
- ISO 1185 K pin
- 7-pin
- 24 V



06

**Short adapter 15-pin to 7-pin**

15-pin to 7-pin

▶ Item no. 3555-320-52

▶ Technical specifications

- Adapter from 15-pin to 7-pin
- ISO 12098
- plastic
- 24 V







01  
**EBS plug 7-pin**  
7-pin

- ▶ Item no. 3555-310-70
- ▶ Technical specifications
  - with screw contacts
  - GGVS / ADR tested
  - 7-pin
  - 24 V



02  
**15-pin connector**  
15-pin

- ▶ Item no. 3555-310-150
- ▶ Technical specifications
  - with screw contacts
  - GGVS / ADR tested
  - 15-pin
  - 24 V



03  
**3-pin connector**  
3 pole

- ▶ Item no. 3555-310-6
- ▶ Technical specifications
  - with screw contacts
  - Type S
  - Load capacity: 20 A to 24 V.
  - plastic
  - 3 pole
  - 24 V



04  
**plug**  
7-pin

- ▶ Item no. 3555-305-587 | Metal
- ▶ Item no. 3555-305-589 | Plastic
- ▶ Technical specifications
  - Load capacity: 20 A to 24 V.
  - Length: 116 mm
  - Type N / „light“
  - with screw contacts



05  
**plug**  
7-pin

- ▶ Item no. 3555-305-586 | Metal
- ▶ Item no. 3555-305-588 | Plastic
- ▶ Technical specifications
  - Load capacity: 20 A to 24 V.
  - Length: 116 mm
  - Type S / „secondary consumers“
  - with screw contacts





01

**Distribution box**

8-fold

► Item no. 1004-100-1

► Technical specifications

- 8-pin cable junction box
- with 32 flat plugs
- 4 rows
- waterproof housing
- Lid material: aluminum
- Housing material: polyester BMC
- Closure: 2 clamps
- Dimensions (L x W x H): 150 mm x 93 mm x 45 mm
- Fixing: 2 holes Ø 5.5 mm
- Center distance (mm) 90.0



02

**Distribution box**

16 times

► Item no. 1004-100

► Technical specifications

- ADR compatible
- TÜV component marking (TÜ.EGG.028-96)
- water-protected, steam jet resistant plastic housing IP69K
- Housing material: PA
- with plug insert (11 potentials 8-pin and 4 potentials 4-pin)
- Closure: 2 clamps or 4 screws (recommended tightening torque: 1.7 Nm)
- Dimensions (L x W x H): 167 mm x 157 mm x 99 mm
- Fixing: 4 holes Ø 5.5 mm
- Center distance 65/110 mm
- 16 PG screw connections



03

**Battery clamps for cars**

max. cable connection: 50 mm<sup>2</sup>

Item No.	execution	PU
3510-1	+ on the left	1
3510-2	- on the left	1
3510-3	- on the right	1
3510-4	+ on the right	1



04

**Battery clamps for commercial vehicles**

Tinned brass

Item No.	execution	PU
3510-7	+ on the left	1
3510-6	- on the right	1



05

**Battery clamps Büssing**

Tinned brass

Item No.	execution	PU
3510-20	- on the left	1
3510-19	+ on the right	1





01

**Start Booster - jump start device for cars and trucks**

Car 12 V

► Item no. 7771-12-24

► Technical specifications

- including charger 12-220 V (4.0 A)
- WITH pole protection
- Voltage: 12 V or 24 V, choice of voltage via plug
- Peak power (SAE) 12 V / 24 V: 7,000 amps / 3,500 amps
- Starting power 12 V / 24 V: 2,300 amps / 1,150 amps
- Charger voltage: 230 V
- Charging: 12 V 4 A
- Battery life \*: 500 cycles (\* based on 50% discharge)
- Cable length: 182 cm
- Copper cable diameter: 50 mm<sup>2</sup>
- Number of built-in 500 A special batteries: 2
- fully insulated clamp
- protected against voltage peaks 2x 500 A fuse
- durable and shockproof ABS housing
- flexible cable with fully insulated, solid copper pliers
- with LED charge level tester



02

**Fuse for booster (Art.-No. 7771-12-24) FOR THE PLIERS FUSE, NEW VERSION**

12V and 24V

► Item no. 7771-12-14

► Technical specifications

- 500 AMP



03

**Battery 12V and 24V**

► Item no. 7771-12-13



04

**Loading clamps**

► Technical specifications

- Length: 155 mm
- Maximum opening width: 40 mm
- weight: 170 g
- fully insulated sheet steel pliers
- screw connection for cable lugs via ring eyelet M6
- screws included



Item No.	colour	power	Application area
7771-16-200	red	200 A	Passenger cars
7771-16-201	black	200 A	Passenger cars
7771-35-600	red	600 A	commercial vehicle
7771-35-601	black	600 A	commercial vehicle

05

**Battery jumper cables**

► Technical specifications

- narrow pliers head for confined space at the battery terminal
- flexible, pure copper cable
- high-quality polyamide pliers
- cables are supplied in a storage bag



Item No.	length	Ø / mm <sup>2</sup>
7771-16	3,0 m	16 für PKW
7771-35	4,5 m	35 mit Überspannungsschutz
7771-50	5,0 m	50 für NFZ

06

**Overvoltage protection**

for welding 12/24 volts

► Item no. 4982-500

► Technical specifications

- for commercial vehicles and cars
- suppresses voltage peaks
- LED connection indicator
- no battery disconnection during welding
- no reprogramming of radio, clock, etc.
- considerable time savings





01  
**40 batteries in a tray**  
in Normfest presentation



- Technical specifications
- 1.5V Mignon AA
- Nominal capacity of 2700 mAh
- cadmium and mercury free
- Alkaline

Item No.	execution	tension	PU
3722-72	Micro AAA	1.5 V	40
3722-71	Mignon AA	1.5 V	40

02  
**VARTA high-energy batteries**  
in blister packaging



Item No.	execution	tension	PU
3722-04	Micro AAA	1.5 volts	4
3722-03	Mignon AA	1.5 volts	4
3722-02	Baby C	1.5 volts	2
3722-01	Mono D	1.5 volts	2
3722-05	Block E	9.0 volts	1

03  
**VARTA high energy batteries**  
Special applications



Item No.	execution	tension	PU
3722-24	V 23 GA	12 volts	1

04  
**VARTA high energy batteries**  
Special applications



Item No.	execution	tension	PU
3722-29	LR 1	1.5 volts	1

05  
**Charger for rechargeable batteries**  
Ansmann Photocam TV

► Item no. 3722-70

- Product description
- for 2 or 4 Micro AAA / Mignon AA batteries
- with automatic battery full detection
- The blue illuminated LCD display provides clear information about the charging status in 25% steps
- small bar charts are easy to read even in the dark thanks to the illuminated display
- Defective rechargeable batteries or inserted batteries are automatically recognized
- Overcharge protection, safety timer and reverse polarity protection
- after the end of charging, the device switches to intelligent impulse maintenance charging
- charges microcontroller-monitored 2 or 4 rechargeable batteries of sizes Micro AAA and Mignon AA
- Thanks to the wide-range input, the PhotoCam IV can be used worldwide (via adapter) from 100 - 240 V.
- Dimensions: 6.5 x 11.8 cm (width x height)



06  
**Rechargeable batteries**  
VARTA Akkus

- Technical specifications
- Ready 2 Use technology
- Voltage: 1.2 Volt
- Packaging: loose or from 10 pcs. in a carton
- Electronic system: Ni-MH

Item No.	execution	Amp hour	PU
3722-40	Micro AAA	800 mAh	1
3722-41	Mignon AA	2100 mAh	1





01

**Battery button cells**

Electronic system: Lithium

Item No.	execution	tension	PU
3722-27	CR 1220	3 volts	1
3722-26	CR 1616	3 volts	1
3722-25	CR 1620	3 volts	1
3722-30	CR 1623	3 volts	1
3722-23	CR 2016	3 volts	1
3722-20	CR 2025	3 volts	1
3722-21	CR 2032	3 volts	1
3722-42	CR 2430	3 volts	1
3722-32	CR 2450	3 volts	1
3722-33	CR 1/3N	3 volts	1
3722-31	LR 44, V13GA	1.5 volts	1
3722-22	625A	1.5 volts	1



02

**Lantern battery**

Block 6V - 50Ah

► Item no. 3722-650

► Product description

- Ideal for lighting, safety devices, alarm systems, construction sites, agriculture and much more.
- Constant discharge curve and therefore constant brightness of the warning lights
- Mercury and cadmium free
- Particularly long operating times
- Shelf life of 2 years



03

**Lantern battery**

Block 4R25 6 volts - 7 Ah

► Item no. 3722-60

► Product description

- 4-R25
- 6V
- 7Ah
- for use in construction site flashing lights



03

**Assortment of button cells**

75-piece

► Item no. 1957-580

► Contents: 75 parts

- 10 x CR1220 3V (item no. 3722-27)
- 10 x CR1616 3V (item no. 3722-26)
- 10 x CR1620 3V (Item No. 3722-25)
- 10 x CR1632 3V (Item No. 3722-30)
- 10 x CR2016 3V (item no. 3722-23)
- 10 x CR2025 3V (item no. 3722-20)
- 10 x CR2032 3V (Item No. 3722-21)
- 5 x LR1 1.5V (4001) (item no. 3722-29)

01

**H7**

24V 70W Px26d

Item No.	execution	Manufacturer
3720-064-274	HD / LL	Osram
3720-064-273	HD / LL	OEM quality
3723-064-211	standard	Normlight



04

**H3**

24V 70W PK22s

Item No.	execution	Manufacturer
3720-064-271	HD / LL	OEM quality
3723-064-151	standard	Normlight



02

**H4**

24V 75 / 70W P43t

Item No.	execution	Manufacturer
3720-064-272	HD / LL	OEM quality
3723-064-196	standard	Normlight
3723-064-197	HD	Normlight



05

**H15**

24V 60 / 20W PGJ23t-1

OEM quality

► Item no. 3720-064-275



03

**H1**

24V 70W P14.5s

Item No.	execution	Manufacturer
3720-064-270	HD / LL	OEM quality
3723-064-155	standard	Normlight



06

**H11**

24V 70W PGJ19-2

OEM quality

► Item no. 3720-064-217







01

**D2S Xenon gas discharge lamp**

12 / 85V 35W P32d-2

▶ Item no. 3720-064-222

- ▶ Technical specifications
- for projection headlights
- approx. 4,100 Kelvin



02

**D2R Xenon gas discharge lamp**

12 / 85V 35W P32d-3

▶ Item no. 3720-064-223

- ▶ Technical specifications
- for reflective headlights
- approx. 4,000 Kelvin



03

**D1S Xenon gas discharge lamp**

12 / 85V 35W PK32d-2

▶ Item no. 3720-064-224

- ▶ Technical specifications
- approx. 4,000 Kelvin
- 3200 lumens



04

**D3S Xenon gas discharge lamp**

12 / 42V 35W PK32d-5

▶ Item no. 3720-064-225

- ▶ Technical specifications
- for reflection headlights
- approx. 4,000 Kelvin
- 3,200 lumens



05

**D4S Xenon gas discharge lamp**

12 / 42V 35W P32d-5

▶ Item no. 3720-064-226

- ▶ Technical specifications
- for reflection headlights
- approx. 4,000 Kelvin
- 3,200 lumens



06

**D4R Xenon gas discharge lamp**

12 / 85V 35W P32d-6

▶ Item no. 3720-064-227

- ▶ Technical specifications
- for reflective headlights
- approx. 4,000 Kelvin
- 2,800 lumens



01

**Taillight lamp**

Base BA15s

Item No.	power	execution	Manufacturer
3720-056-27	5W	OEM quality	OEM quality
3720-752-3	5W	5W HD LL	OEM quality
3720-056-37	10W	10W	OEM quality
3720-752-5	10W	10W HD LL	OEM quality
3723-562-7	5W	HD	Normlight
3723-563-7	10W	HD	Normlight



04

**24V PY21W flashing light bulb HDLL yellow**

Base BAU15S

► Item no. 3720-752-2

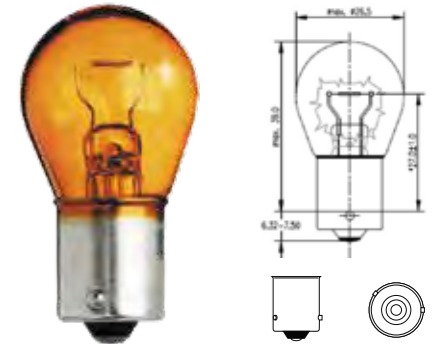

02

**24V indicator or brake light lamp**

Base BA15s

Item No.	power	execution	Manufacturer
3720-075-35	18W	OEM quality	OEM quality
3720-075-11	21W	OEM quality	OEM quality
3720-752-1	21W	21W HD LL	OEM quality
3723-075-11	21W	Normlight	Normlight
3723-751-1	21W 21W HD	Normlight	Normlight

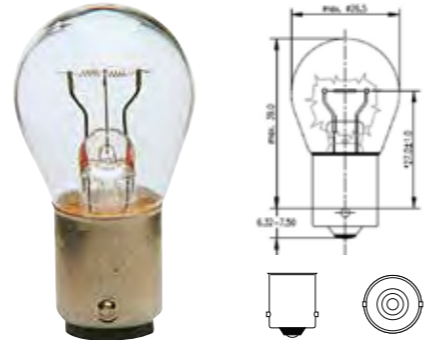

05

**Brake or tail light lamp**

24 V BAY15d

Item No.	power	execution	Manufacturer
3723-075-37	21/5W	21/5W	Normlight
3720-075-37	21/5W	21/5W	OEM quality



06

**Taillight lamp**

Base BAZ15d

► Item no. 3720-075-47



03

**Brake and tail light lamp**

Base BAY15d

Item No.	power	Manufacturer
3720-075-37	21/5W	OEM quality
3720-075-371	21/5W	OEM quality



07

**Taillight lamp**

Base BA15d

► Item no. 3720-056-26





01

**Wedge base bulb** Base W2.1x9.5d

Item No.	power	Manufacturer
3720-028-40	2W	OEM quality
3720-028-41	3W	OEM quality
3720-028-45	5W	OEM quality
3723-028-45	5W	Normlight

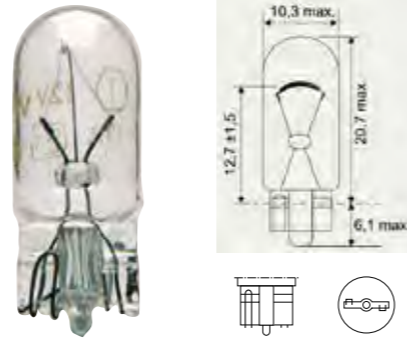

04

**Parking light lamp**  
24V T4W parking light bulb HDLL

Item No.	power	execution	Manufacturer
3720-752-6	4W	4W HD LL	OEM quality
3723-393-0	4W	HD	

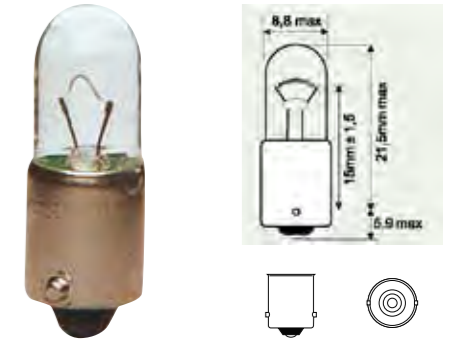

02

**Wedge base bulb**  
Base W2x4.6d

► Item no. 3720-027-41

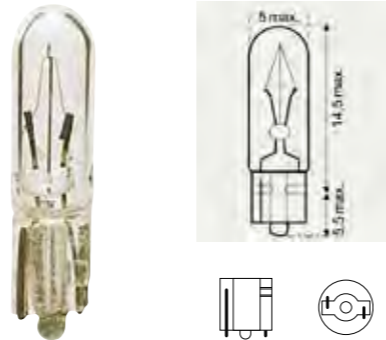

05

**24V 3W parking light and indicator lamp**  
Base BA7s

► Item no. 3720-038-99



03

**24V parking light and indicator lamp**  
Base BA9s

Item No.	power	Manufacturer
3720-037-97	2W	OEM quality
3720-039-30	4W	OEM quality

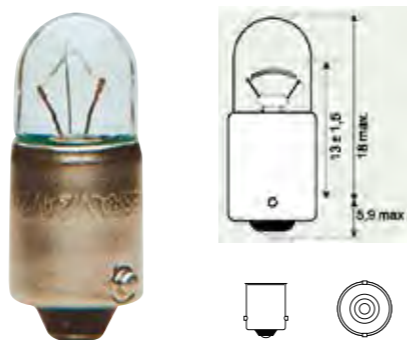

06

**24V 21W halogen flashing lamp**  
Base BAY9s

► Item no. 3720-075-13



01

**Soffit lamp**

Base SV8,5-8

Item No.	power	length	Ø mm
3720-064-23	5W	35 mm	11
3720-064-24	5W	41 mm	11
3720-064-29	10W	41 mm	11
3720-064-80	18W	41 mm	15



05

**Plastic base lamp yellow**

24V 1.2W

► Item no. 3720-027-605



06

**Plastic base lamp green**

Base EBS R11 green

► Item no. 3720-027-420

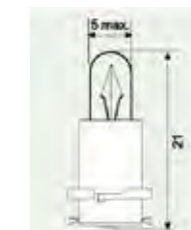

02

**24V 5W festoon lamp**

SV8.5 socket

► Item no. 3720-064-30



07

**Plastic base lamp grey**

Base B8.5d gray

► Item no. 3720-027-419



08

**Plastic base lamp brown**

Base Bx8.5d brown

► Item no. 3720-027-600

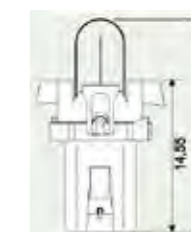

03

**Plastic base lamp**

Base B8.3d gray

► Item no. 3720-027-404

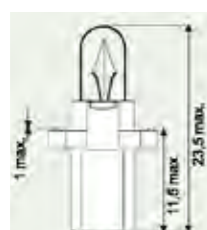

04

**Plastic base lamp yellow**

24V 1.2W

► Item no. 3720-027-610

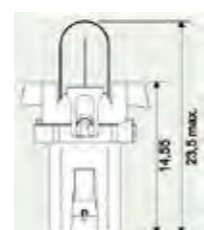

09

**Plastic base lamp white**

24V 1W

► Item no. 3720-027-606



10

**Plastic base lamp white**

24V 2,4V B9

► Item no. 3720-027-603







**01**  
**Glowpoint LED**  
Base BA15s

- ▶ Item no. 3720-075-15
- ▶ Technical specifications
  - up to 10,000 operating hours
  - strong luminosity
  - Energy and cost efficient
  - break-proof housing



**02**  
**Replacement light bulb**  
RX-T / E 18W / 830 GX 24q-2

- ▶ Item no. 3720-064-230
- ▶ Technical specifications
  - Luminous efficacy: 3000 Kelvin



**03**  
**24V H1 / H7 commercial vehicle lamp replacement box, HDLL**  
Normlight quality

- ▶ Item no. 3723-030
- ▶ Content:
  - 2x plug-in fuse 10A (item no. 3731-010)
  - 2x 15A plug-in fuse (item no. 3731-015)
  - 2x plug-in fuse 20A (item no. 3731-020)
  - 2x plug-in fuse 25A (item no. 3731-025)
  - 2x parking lights 4W HD (item no. 3723-393-0)
  - 2x tail lights 10W HD (item no. 3723-563-7)
  - 8x indicator and brake light 21W (item no. 3723-075-11)
  - 2x Soffite 8.5-8 10W (Item no. 3720-064-29)
  - 1x main headlight H1 (Item no. 3723-064-155)
  - 1x main headlight H7 (Item No. 3723-064-211)



**04**  
**24V H1 / H7 commercial vehicle lamp replacement box**  
18 pieces, H1 / H7 Normlight quality

- ▶ Item no. 3723-031
- ▶ Content:
  - 3x plug-in fuse 10A (item no. 3731-110)
  - 3x plug-in fuse 15A (item no. 3731-115)
  - 2x tail lights 10W HD (item no. 3723-563-7)
  - 2x tail light 5W HD (item no. 3723-562-7)
  - 2x indicator or brake light bulb 21W HD (item no. 3723-751-1)
  - 2x flashing light lamp yellow PY21W HDLL (item no. 3720-752-2)
  - 2x main headlights H1 (item no. 3723-064-155)
  - 2x main headlights H7 HDLL (item no. 3723-064-273)









**05**  
**Spare lamp box empty**  
for 12V / 24V H7 / H1

- ▶ Item no. 3720-03-222
- ▶ Technical specifications
  - 18 cm x 9.5 cm x 5 cm
  - transparent lid









01

**Socket housing**

Item No.	execution	PU	image
3558-89	2 pole	10	
3558-891	3 pole	10	
3558-892	4 pole	10	
3558-893	6 pole	10	
3558-894	8 pole	10	
3558-895	12 pole	10	







02

**Socket contact protection**

Item No.	execution	Packing unit	image
3558-910	2 pole	100	
3558-911	3 pole	100	
3558-912	4 pole	100	
3558-913	6 pole	100	
3558-914	8 pole	100	
3558-915	12 pole	100	

03

**Pin housing**

Item No.	execution	Packing unit	image
3558-900	2 pole	10	
3558-901	3 pole	10	
3558-902	4 pole	10	
3558-903	6 pole	10	
3558-904	8 pole	10	
3558-905	12 pole	10	

04

**Pin contact fuse**

Item No.	execution	Packing unit	image
3558-920	2 pole	100	
3558-921	3 pole	100	
3558-922	4 pole	100	
3558-923	6 pole	100	
3558-924	8 pole	100	
3558-925	12 pole	100	



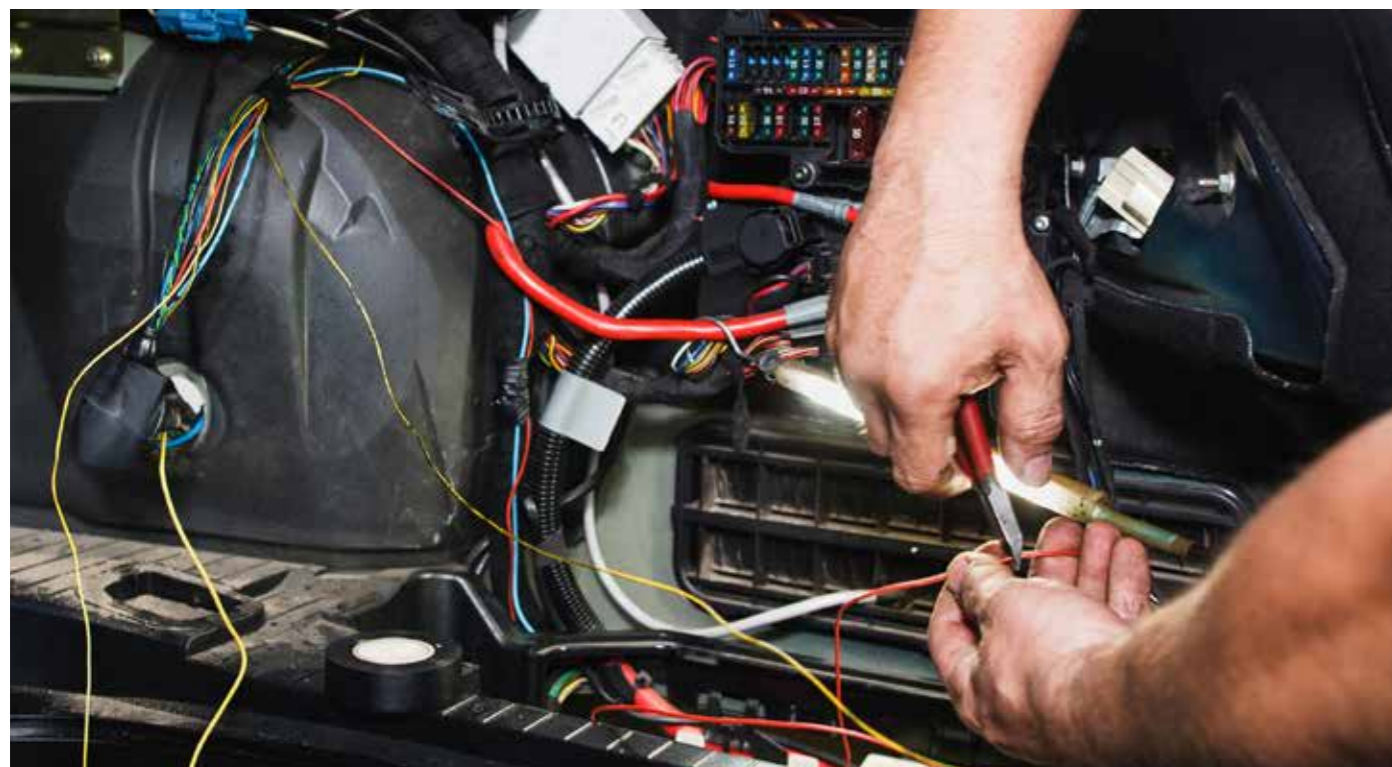

01  
**Turned socket contact**

Item No.	execution	PI	image
3558-940	0,5-1,5 mm	50	
3558-941	2,0 mm	50	

02  
**DT turned pin contact, Deutsch connector**

Item No.	execution	PU	image
3558-950	0,5-1,5 mm	50	
3558-951	2,0 mm	50	

03  
**DT sealing plug, Deutsch plug**

► Item no. 3558-930



04  
**Crimping pliers set for DT 6 in 1**  
for German plug

► Item no. 8558-106

- Contents of the case:
- Pliers
  - 6 dies
  - Die K1 AWG 14/12 for the DT P series
  - Die K2 AWG 10/12 5 / 6mm<sup>2</sup> for the DT P series
  - Die K3 AWG 18/16/14 for the DT P series
  - Die K4 AWG 20/18/16 for the DT P series
  - Die K5 AWG 20 / 18-16 for the DT P series
  - Die K6 AWG 16/14/12 for the DT P series



05  
**Die for insulated connections**  
Plug 0.1 - 1.5 mm

► Item no. 8558-100-13



06  
**Die for uninsulated connections**  
Plug 0.1 - 1.0 mm

► Item no. 8558-100-14







02

**Tyron for LKW / AS / EM**

CoPrA® tire repair set

► Item no. 9879-971

► Technical specifications

- Tread damage: max. 10 mm
- Repair body 100% self-vulcanizing
- Tests at TÜV-Süd, Tire and Wheel Test Center Munich: Endurance run and top speed: ECE R54 for truck tires, compliant with §36 StVZO
- state-of-the-art technology makes it extremely tear and shear-resistant in the tire and steel belt
- Can be used for straight and up to 45° inclined grooves
- for all tubeless truck tires / AS / EM
- - removes existing moisture in the repair area
- - converts existing rust into solid, inert material and
- - protects against new rust (CoPrA®)
- pat. pend (dpa)
- no drying time required for the vulcanizing solution

Contents of the set:

- 
- 25 x 10mm repair body (Article No. 9879-974 - refill pack)
- 1 x introducer awl (Article No. 9879-976)
- 1 x T-handle (Item No. 9879-975)
- 1 x piercer (Item No. 9879-978)
- 1 x vulcanizing compound CoPrA® pat. pend 25ml (Article No. 9879-980)
- 1 x liquid plaster CoPrA® pat. pend 50ml (Article No. 9879-979)
- 1 x scraper
- 1 x Allen key

01

**Tyron for LKW / AS / EM**

Refill pack CoPrA®

► Item no. 9879-974

► Content:

- 25 x 10 mm repair body
- 1 x liquid plaster CoPrA® pat. pend 50ml





01

**Cutter**

For mushroom-shaped repair bodies for repairing defective tires

Item No.	Ø
9879-93-03	3,0 mm
9879-93-06	6.0 mm



02

**Scooter**

for tire probes

- ▶ Item no. 9879-91-2
- ▶ PU: 1



03

**Special rubber milling cutter**

for roughening the inner surface of the tire

- ▶ Item no. 9879-91-1
- ▶ PU: 1



04

**T-handle**

- ▶ Item no. 9879-975
- ▶ PU: 1



05

**Inset**

for Tyron repair kit

Item No.	Length [mm]	suitable for:
9879-976	115	Passenger cars
9879-977	195	truck



06

**Vorstecher für Tyron Reparatur-Set CoPrA®**

for cleaning the branch duct

- ▶ Item no. 9879-978
- ▶ PU: 1



07

**Liquid plaster CoPrA® for Tyron repair set**

- ▶ Item no. 9879-979
- ▶ Content: 50 ml
- ▶ PU: 1

- ▶ Technical specifications
- with corrosion protection
- Liquid plaster must be applied from the inside to the damaged area / loop



08

**Vulcanizing compound CoPrA® for Tyron repair set**

- ▶ Item no. 9879-980
- ▶ Content: 25 ml
- ▶ PU: 1

- ▶ Technical specifications
- with corrosion protection
- for insertion into the puncture channel of the damaged area



09

**Tyre probes**

Refill pack for the Tyrex repair system

- ▶ Technical specifications
- Mushroom-shaped repair body suitable for radial and cross-ply tires
- permitted for speed class V.
- Processing only in connection with the vulcanizing compound (Article No. 9879-94-250)

Item No.	Ø mm	PU
9879-92-03	3	25
9879-92-04	4,5	24
9879-92-06	6	24
9879-92-10	10	10

10

**Tyrex**

Adhesive for tire probes

- ▶ Item no. 9879-94-250
- ▶ Content: 236 ml
- ▶ PU: 1



01

**Tire fitting paste**

Black tap / White tap

- ▶ Item no. 2894-455
- ▶ Content: 5 kg
- ▶ Colour: black
- ▶ PU: 1

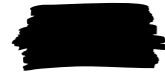

- ▶ Item no. 2894-457
- ▶ Content: 5 kg
- ▶ Colour: white
- ▶ PU: 1



▶ **Technical specifications**

- manufactured according to TÜV guidelines
- suitable for run-flat tires
- frost-proof
- quick drying so that the tire cannot slip on the rim
- excellent ventilation behavior
- high lubricity
- biodegradable
- no risk of allergies for the fitters



02

**Tire fitting paste**

Run-tap

- ▶ Item no. 2894-459
- ▶ Content: 5 kg
- ▶ PU: 1

▶ **Technical specifications**

- especially for run-flat, wide and low profile tires
- increased sliding effect with optimal sealing effect
- dries quickly and transparently
- also for warm / hot regions
- no drying out in an open bucket
- Consistency: creamy
- Colour blue
- Processing temperature: -10 ° C to 50 ° C



03

**Tire fitting spray**

Run fluid

- ▶ Item no. 2894-460-400
- ▶ Content: 400 ml
- ▶ Quantity per box: 6

- ▶ Item no. 2894-460
- ▶ Content: 5 Liter
- ▶ PU: 1

▶ **Technical specifications**

- quick and easy installation of all types of tires (including motorcycle, low profile and wide tires)
- fast drying
- does not leave any visible residue on tire edges
- prevents assembly damage to the tire flanks
- easy to dose because it can be sprayed
- silicone free



04

**Tire chalk**

strong and smudge-proof grease chalk

- ▶ Item no. 9879-91-3
- ▶ Colour: white
- ▶ PU: 12



- ▶ Item no. 9879-91-4
- ▶ Colour: yellow
- ▶ PU: 12



▶ **Technical specifications**

- 17.5 mm diameter
- approx 28g
- with tip for writing and precise identification
- 12 pieces per pack
- Holders are available separately (Article No. 9879-91-5)

05

**bracket**

for tire chalk

- ▶ Item no. 9879-91-5
- ▶ PU: 1



06

**brush**

for tire fitting paste

- ▶ Item no. 4693-080-0
- ▶ PU: 1





01

**Hand tire inflator**

for cars

► Item no. 9879-54-05

► Item no. 9879-54-08 | Replacement hose

► **Technical specifications**

- Calibrated (from the stamp date for two years)
- Filling pressure: max. 12 bar
- for cars / trucks
- Rubber protective cap protects the mechanics from external impacts
- Overpressure safety protection
- easy to read
- weight-optimized design
- Integrated kink protection stabilizes the filling hose at the outlet
- 500 mm long filling hose for valves that are difficult to access
- with hanging loop
- ergonomic design
- Single lever operation
- PTB approval
- Compressed air testing is also possible without applying pressure



02

**Hand tire inflator**

with digital display, calibrated

► Item no. 9879-54-04

► Item no. 9879-54-042 | Replacement hose

► **Technical specifications**

- calibrated
- PTB approval
- modern, lightweight, shockproof construction
- clear and easy to read display
- Single stage valve design increases fill and drain speeds
- Overpressure warning if pressure exceeds 12 bar / 174 PSI / 1,200 kPa
- Low battery warning light
- Connection thread: 1/4 "IT
- Filling hose length: 180 cm
- max. inlet pressure: 15 bar
- max. filling time: 910 l / min
- Filling range: 0 - 12 bar
- Battery item number 3722-32 CR 2450
- Battery life: up to 950h
- System-bound software increases accuracy, fine measurement and eliminates the possibility of incorrect readings



03

**Gas station plug**

for hand tire inflator

► Item no. 9879-54-07

► PU: 1

► **Technical specifications**

- for hose inside diameter 7 mm
- Connection piece diameter 8 mm
- Length approx. 355 mm



04

**Valve lever connector**

for hand tire inflator

► Item no. 9879-54-06

► PU: 1

► **Technical specifications**

- for hose inside diameter 6 mm
- Total length approx. 40 mm
- Diameter of the valve inlet side approx. 18 mm
- Pin diameter: 7mm



01

**Metal valve**

for tubeless commercial vehicle tires

► **Technical specifications**

- Rim valve for tubeless commercial vehicle tires with O-ring seal
- for steep shoulder rims
- Valve hole diameter: 9.7 0.3mm
- Rim thickness: 3.0mm - 6.0mm
- Tightening torque: 12 to 15 Nm
- Pressure range: <14 bar

Item No.	Length	Ø	PU
9879-800-41	41 mm	9,7 mm	1
9879-800-70	70 mm	9,7 mm	10



02

**Metal / rubber valve**

for vans and mobile homes

► **Technical specifications**

- secure sealing in the rim
- easy installation
- easy dismantling without special tools
- no rim damage during dismantling
- high pressure resistance
- Pressure load up to 7 bar
- Temperature resistant from -40 ° to 130 °
- Valve hole diameter: 11.3 0.4mm
- Rim thickness: 1.8mm - 4mm
- ETRTO no .: V0.07.3

Item No.	Length	PU
9879-530-40	40 mm	50
9879-530-47	47 mm	50
9879-530-60	60 mm	50



03

**Metal valve**

for vans, cars and vehicles with high tire pressure

► **Technical specifications**

- pressure load up to 14 bar
- Wrench size 11
- High temperature seal for peak temperatures above 150 ° C

Item No.	Length	SW	PU
9879-413-40	40 mm	11 mm	25
9879-414-47	47 mm	11 mm	25



04

**Screwing in and out tool**

for all common valves

► **Item no. 9879-54-00**

► **PU: 1**

► **Technical specifications**

- Tightening torque: approx. 25-30 Nm



05

**Valve retraction lever**

Plastic coating

► **Item no. 9879-54-041**

► **PU: 1**

► **Technical specifications**

- Length: 290 mm



06

**Valve extension**

Air-Flexx

► **Technical specifications**

- Steel, flexible

Item No.	Length	PU
9879-700-145	145 mm	6
9879-700-185	185 mm	6
9879-700-215	215 mm	6



07

**Adhesive weight remover**

plastic

► **Item no. 8715-64-80**

► **PU: 1**

► **Technical specifications**

- For loosening glued trim strips on the body and on the rims



08

**Extension cap with seal**

check valve

► **Item no. 9879-66**

► **PU: 25**

► **Technical specifications**

- unscrewing is not necessary for filling or pressure testing
- insensitive to dirt and water
- prevents pressure loss even if the valve insert is damaged or dirty
- fits every standard valve



09

**Valve extension**

with support tube

► **Technical specifications**

- Plastic, rigid

Item No.	Length	PU
9879-74	115 mm	20
9879-75	150 mm	20
9879-76	170 mm	20







**01**  
**Lead impact weight**  
for steep shoulder rims type 530

- **Technical specifications**  
- 22.5 „x 6.75“ to 26.50 „x 12.00“

Item No.	Weight	PU
9836-32-50	50 g	10
9836-32-75	75 g	10
9836-32-100	100 g	10
9836-32-150	150 g	10
9836-32-200	200 g	10
9836-32-250	250 g	10
9836-32-300	300 g	10
9836-32-350	350 g	10
9836-32-400	400 g	10



**02**  
**Zinc impact weight**  
for steel rims FORD type 187

- **Technical specifications**  
- Original part from FORD Transit and FORD Transit Custom 05/2014

Item No.	Weight	PU
9836-187-10	10 g	100
9836-187-15	15 g	100
9836-187-20	20 g	100
9836-187-25	25 g	100
9836-187-30	30 g	100
9836-187-35	35 g	50
9836-187-40	40 g	50
9836-187-45	45 g	50
9836-187-50	50 g	50
9836-187-55	55 g	50
9836-187-60	60 g	50



**03**  
**Zinc impact weight**  
for steel rims type 164

- **Technical specifications**  
- Original part from MERCEDES-BENZ Sprinter  
- for steel rims of French vehicles  
- for steel rims of light trucks (with greater material thickness of the rim)  
- FORD Transit until 2013  
- VW Crafter

Item No.	Weight	PU
9836-164-5	5 g	100
9836-164-10	10 g	100
9836-164-15	15 g	100
9836-164-20	20 g	100
9836-164-25	25 g	100
9836-164-30	30 g	100
9836-164-35	35 g	50
9836-164-40	40 g	50
9836-164-45	45 g	50
9836-164-50	50 g	50
9836-164-55	55 g	50
9836-164-60	60 g	50



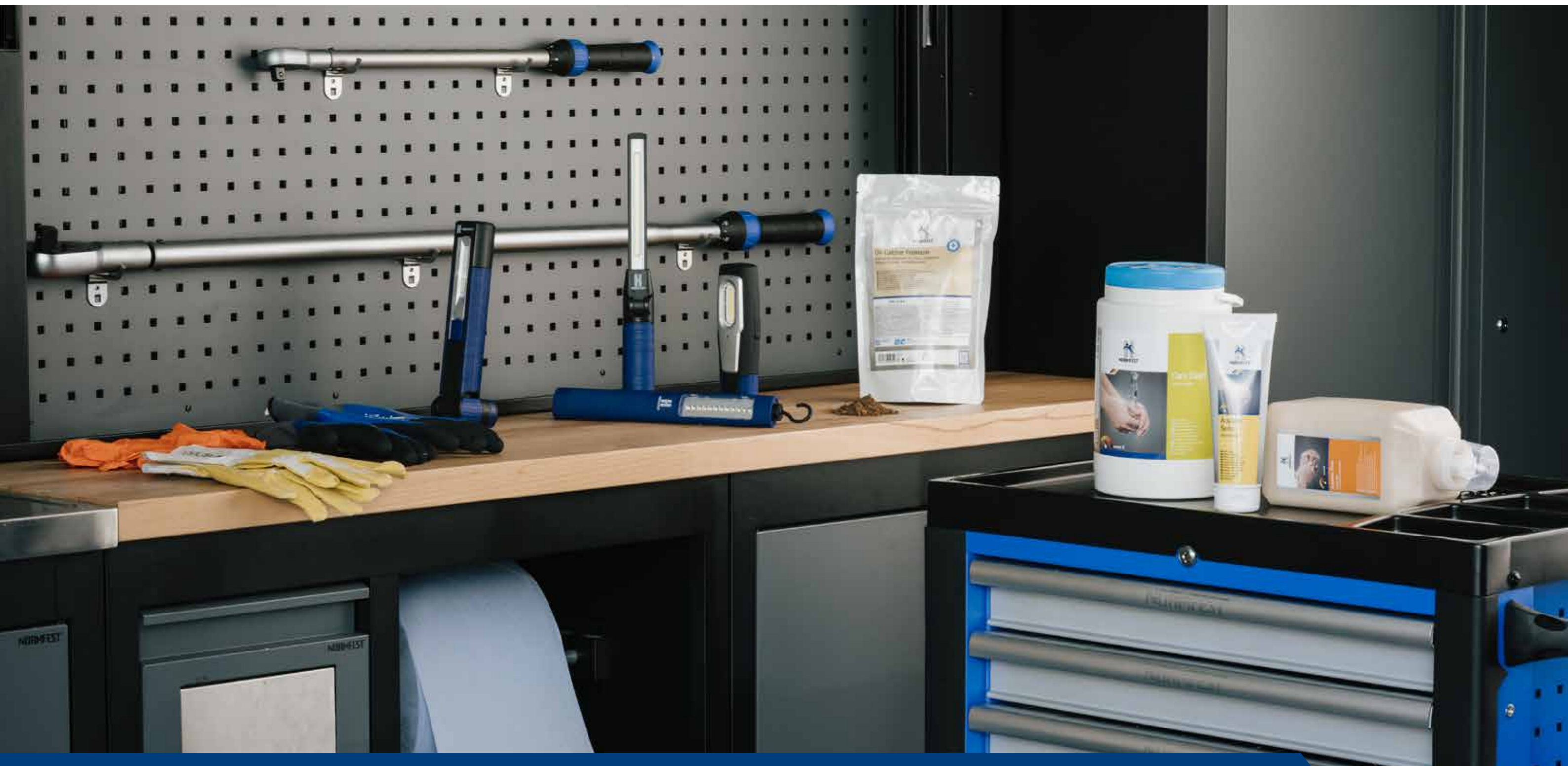

Workshop equipment





Our entire selection workshop trolleys can be found under „Hand Tools“







01  
**Cleaning paper roll**  
2-ply, 1,000 tear-offs

- ▶ Technical specifications
- Roll Ø: 29cm
- colour: blue
- with embossing, fully glued



Item No.	Dimensions	execution	PU
7875-502	22 x 36	22 x 36 cm embossed, fully coated	2
7875-503	36 x 38	36 x 38 cm embossed, fully coated	2
7875-504	38 x 36	36,5 x 36,5 cm	2

02  
**Wall holder**  
max.roll width 75 cm

- ▶ Item no. 7875-901
- ▶ Product description
- for 3 compact rolls, max.roll width 75 cm
- Slip covers, compact rolls and garbage bags
- H x W x D: 70 x 76 x 24 cm

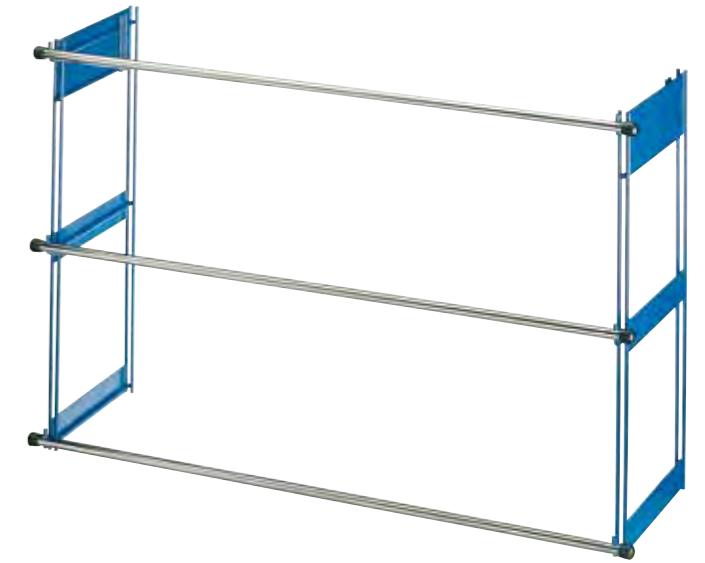

03  
**Stand for cleaning paper**  
for cleaning paper

- ▶ Item no. 7875-3
- ▶ Product description
- max.roll width 40 cm



04  
**Wall holder**  
max.roll width 40 cm

- ▶ Item no. 7875-2
- ▶ Product description
- max.roll width 40 cm





01

**Non-woven cloth roll**

500 Shelter

▶ Item no. 7875-505

▶ PU: 2

▶ Technical specifications

- lint free
- Can be used wet and dry
- biodegradable
- Components: 55% wood flour - 45% polyester (without binding agent)
- Color turquoise
- resistant to solvents
- high absorption capacity
- is sold as a double role
- 500 breaks per roll
- Leaf height: 38 cm
- Sheet width: 30 cm



03

**Non-woven cloth roll**

perforated, 400 tear-offs

▶ Item no. 7875-500

▶ PU: 1

▶ Technical specifications

- Color white
- extremely strong suction
- very wet, tear and abrasion resistant
- Washable and wringable
- solvent resistant
- silicone free
- food safe
- perforated
- 400 demolitions
- Roll length: 152m
- Dimensions: W29 cm x L38 cm



02

**Non-woven cleaning cloth**

perforated, 400 tear-offs

▶ Item no. 7875-5

▶ PU: 2

▶ Technical specifications

- very absorbent
- high cotton content
- wringable
- tearproof
- resistant to most solvents
- 2 rolls per packaging unit
- 400 wipes per roll
- 29 x 38 cm
- Perforation for easy tear-off
- textile wipes (70% cotton, 15% synthetic fibers, 15% PP)



04

**Pulp roll**

2-ply, 750 tear-offs

▶ Item no. 7875-1

▶ PU: 2

▶ Technical specifications

- Roll length: 255 m
- Color white
- absorbent
- 2-ply
- Dimensions: 23.5 x 34 cm



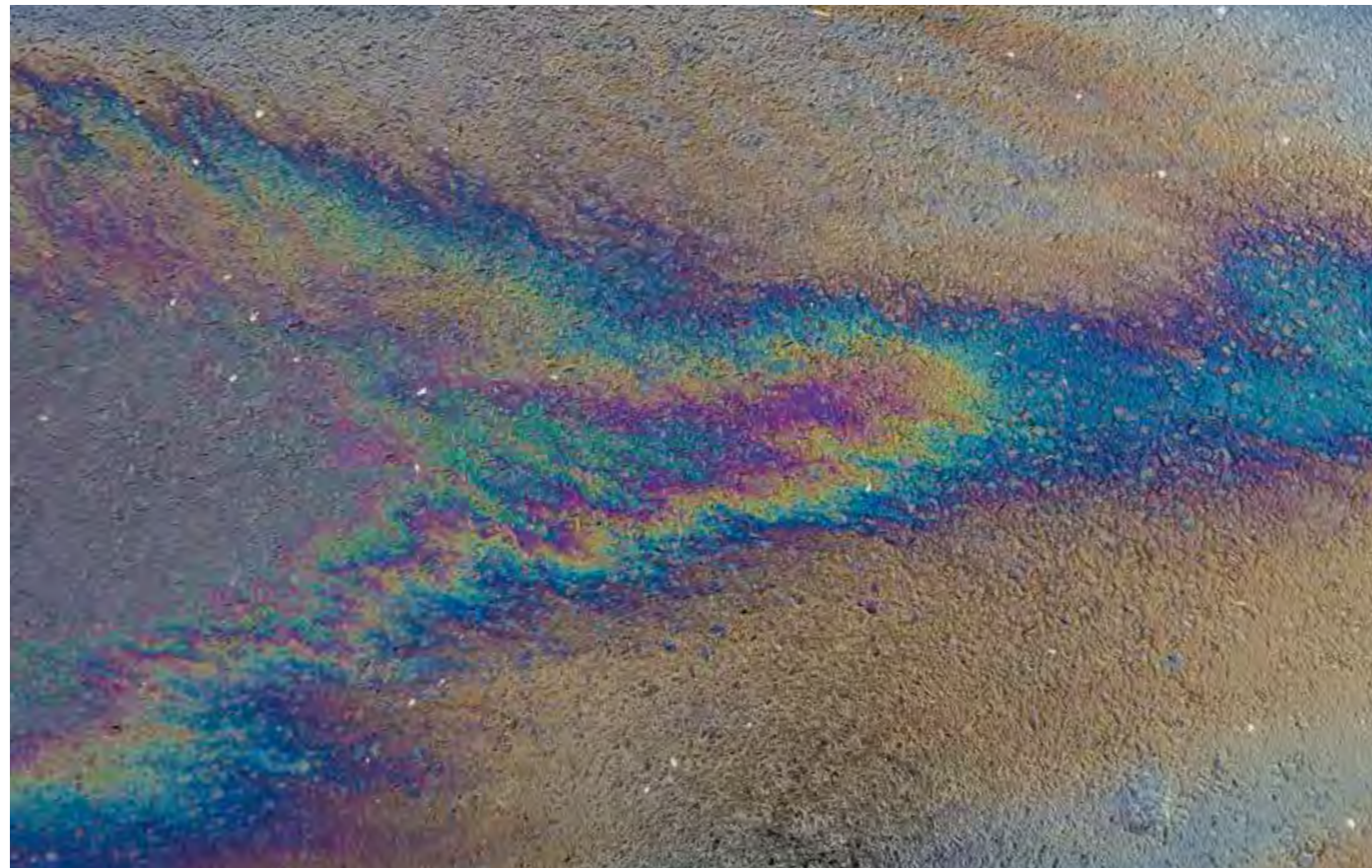

01  
**Oil binder**  
Oil catcher outdoor

- ▶ Item no. 7874-40
- ▶ Content: 40 litre
- ▶ PU: 1

▶ Technical specifications

- an oil binder that was specially developed for outdoor use
- has such a heavy weight that there are no more drifts
- Grain: 0.125 - 4.0 mm



02

**Oil binder**  
Oil-Catcher Premium Protect



- ▶ Item no. 7874-150-1
- ▶ Content: 1 litre
- ▶ PU: 1

- ▶ Item no. 7874-150
- ▶ Content: 50 litres
- ▶ PU: 1

▶ Technical specifications

- rapid absorption of oils, chemicals, fuels, paints and much more.
- for outdoor and indoor use
- organic binder
- universally applicable
- Basis: natural fiber
- pH value: 3.8
- applicable under all conditions
- reusable until saturation is reached
- non-toxic for humans, animals and the environment
- can be used on any surface
- economical and easy to use
- easy to dispose of
- no sustainable pollution of soil, water or groundwater
- no long-term physical or visual effect on the environment



- Oil-Catcher Premium is an organic binder that quickly and effectively absorbs oils, fuels, chemicals, lubricants, emulsions, paints, solvents, coolants and other synthetic and mineral oil-containing liquids.
- The product can be used universally on water, asphalt and soil to combat contamination. The organic fiber is non-toxic, has no negative impact on the environment and can be easily disposed of after use. Oil-Catcher Premium is already effective after 1 to 2 seconds and binds up to 8 times its own weight! With a volume of only 120g / liter, Oil-Catcher Premium is extremely light, economical and easy to use.

- Oil-Catcher Premium meets the requirements for oil binders of the Federal Ministry for the Environment and Nature Conservation Germany for TYPE I waters, TYPE II soil, TYPE III trade and industry, TYPE R roads and traffic areas.



01

**Universal workshop cleaner**

Bio Star Extreme



- ▶ Item no. 2897-270-5
- ▶ Content: Uni-Star

- ▶ Item no. 2897-270-30
- ▶ Content: 30 liters

▶ **Technical specifications**

- highly active cleaning concentrate
- for removing oils, fats, soot and heavy soiling of all kinds
- For hall and workshop floors, washrooms and workrooms, wall and floor tiles, beams, ceilings, gates and tarpaulins
- No labeling required from the Protect series
- AOX

**Pouring tap**

- ▶ Item no. 2000-000-005
- ▶ PU: 1
- ▶ for 5 liter containers

- ▶ Item no. 2000-000-030
- ▶ PU: 1
- ▶ for 30 liter containers



02

**Oil stain remover**

Oil Ex

- ▶ Item no. 2897-341
- ▶ Content: 400 ml
- ▶ Quantity per box: 12

▶ **Technical specifications**

- effective helper against oil and used oil stains
- removes oil stains on all absorbent and non-absorbent surfaces, such as stone, natural and concrete stone, clay and pumice stone, screed, clinker and ceramics
- Can also be used on carpets and textile floor coverings
- Color white
- Important: Do not use on bitumen, asphalt or slate!



03

**Marking spray**

Marker

- ▶ Item no. 2893-886-2
- ▶ Content: 500 ml
- ▶ colour: red
- ▶ Quantity per box: 15

- ▶ Item no. 2893-886-4
- ▶ Content: 500 ml
- ▶ colour: yellow
- ▶ Quantity per box: 15

▶ **Technical specifications**

- high-quality, fast-drying special lacquer
- weather and chemical resistant
- good adhesion properties
- high solids content
- very high opacity and luminosity
- the 360° valve allows all-round marking



01

**40 batteries in a tray**  
in Normfest presentation

- Technical specifications
- 1.5V Mignon AA
- Nominal capacity of 2700 mAh
- cadmium and mercury free
- Alkaline



Item No.	execution	tension	PU
3722-72	Micro AAA	1.5 V	40
3722-71	Mignon AA	1.5 V	40

02

**VARTA high-energy batteries**  
in blister packaging



Item No.	execution	tension	PU
3722-04	Micro AAA	1.5 volts	4
3722-03	Mignon AA	1.5 volts	4
3722-02	Baby C	1.5 volts	2
3722-01	Mono D	1.5 volts	2
3722-05	Block E	9.0 volts	1

03

**VARTA high energy batteries**  
Special applications



Item No.	execution	tension	PU
3722-24	V 23 GA	12 volts	1

04

**VARTA high energy batteries**  
Special applications



Item No.	execution	tension	PU
3722-29	LR 1	1.5 volts	1

05

**Charger for rechargeable batteries**  
Ansmann Photocam TV

► Item no. 3722-70

► Product description

- for 2 or 4 Micro AAA / Mignon AA batteries
- with automatic battery full detection
- The blue illuminated LCD display provides clear information about the charging status in 25% steps
- small bar charts are easy to read even in the dark thanks to the illuminated display
- Defective rechargeable batteries or inserted batteries are automatically recognized
- Overcharge protection, safety timer and reverse polarity protection
- after the end of charging, the device switches to intelligent impulse maintenance charging
- charges microcontroller-monitored 2 or 4 rechargeable batteries of sizes Micro AAA and Mignon AA
- Thanks to the wide-range input, the PhotoCam IV can be used worldwide (via adapter) from 100 - 240 V.
- Dimensions: 6.5 x 11.8 cm (width x height)



06

**VARTA high-energy batteries**  
in blister packaging

Item No.	execution	Amp hour	PU
3722-40	Micro AAA	800 mAh	1
3722-41	Mignon AA	2100 mAh	1





01

**Battery button cells**

Electronic system: Lithium

Item No.	execution	tension	PU
3722-27	CR 1220	3 volts	1
3722-26	CR 1616	3 volts	1
3722-25	CR 1620	3 volts	1
3722-30	CR 1623	3 volts	1
3722-23	CR 2016	3 volts	1
3722-20	CR 2025	3 volts	1
3722-21	CR 2032	3 volts	1
3722-42	CR 2430	3 volts	1
3722-32	CR 2450	3 volts	1
3722-33	CR 1/3N	3 volts	1
3722-31	LR 44, V13GA	1.5 volts	1
3722-22	625A	1.5 volts	1



02

**Lantern battery**

Block 6V - 50Ah

► Item no. 3722-650

► Product description

- Ideal for lighting, safety devices, alarm systems, construction sites, agriculture and much more.
- Constant discharge curve and therefore constant brightness of the warning lights
- Mercury and cadmium free
- Particularly long operating times
- Shelf life of 2 years



03

**Lantern battery**

Block 4R25 6 volts - 7 Ah

► Item no. 3722-60

► Product description

- 4-R25
- 6V
- 7Ah
- for use in construction site flashing lights



04

**Assortment of button cells**

75-piece

► Item no. 1957-580

► Contents: 75 parts

- 10 x CR1220 3V (item no. 3722-27)
- 10 x CR1616 3V (item no. 3722-26)
- 10 x CR1620 3V (Item No. 3722-25)
- 10 x CR1623 3V (Item No. 3722-30)
- 10 x CR2016 3V (item no. 3722-23)
- 10 x CR2025 3V (item no. 3722-20)
- 10 x CR2032 3V (Item No. 3722-21)
- 5 x LR1 1.5V (4001) (item no. 3722-29)

01

**Wet and dry vacuum cleaner**

NF1200W

▶ Item no. 7983-010-1

## ▶ Product description

- Power: 1200 watts - max. 1400 watts
- Air flow: 215 m<sup>3</sup> / hour
- Volume: 60 dB
- Tank capacity: 21 liters
- Weight: 9.2 kg
- Height: 54cm
- Width below: 40cm
- Width at the head: 34cm

## - Scope of delivery:

- Power cable: 8.5 m
- Suction hose: 4.0 m
- Suction hose Ø: 36 mm
- Crevice nozzle 35 cm long
- Bristle nozzle
- Upholstery nozzle
- dust filter
- Sponge filter
- operation manual



02

**Crack nozzle**

For Normfest vacuum cleaner NT1200W item no. : 7983-010-1

- ▶ Item no. 7983-010-12
- ▶ Length: 35 cm
- ▶ Item no. 7983-010-19
- ▶ Length: 12 cm



03

**Pet hair remover brush**

For Normfest vacuum cleaner NT1200W item no. : 7983-010-1 Item no. 7983-010-18

## ▶ Product description

- removes stubborn animal hair easily, quickly, thoroughly and efficiently
- Specially designed to remove pet hair from cars, clothing, mats, carpets, furniture, etc.
- fits all vacuum cleaners with tube dimensions 32 and 35 mm (99% of all vacuum cleaner types)
- can be used by hand as a brush or with a vacuum cleaner



04

**Upholstery nozzle standard**

For Normfest vacuum cleaner NT1200W item no. : 7983-010-1

▶ Item no. 7983-010-14



06

**Suction hose**

For Normfest vacuum cleaner NT1200W item no. : 7983-010-1

▶ Item no. 7983-010-11

- ▶ Product description
- Length: 4 m
- Ø 36 mm



08

**Dust filter standard**

for NT1200W and NT1200SP

▶ Item no. 7983-010-15



05

**Bristle nozzle**

For Normfest vacuum cleaner NT1200W item no. : 7983-010-1

▶ Item no. 7983-010-13

- ▶ Product description
- Ø 35 mm



07

**Suction hose holder**

For Normfest vacuum cleaner NT1200W item no. : 7983-010-1

▶ Item no. 7983-010-17



09

**Sponge filters for liquids**

for NT1200W and NT1200SP

▶ Item no. 7983-010-16

## ▶ Product description

- For Normfest vacuum cleaner NT1200W item no. : 7983-010-1





01

**Wet-dry vacuum cleaner**

NF1200 SP

▶ Item no. 7983-011-1

▶ Product description

- with spray function
- Power: 1200 watts - max. 1400 watts
- Air flow: 215 m<sup>3</sup> / hour
- Volume: 60 db
- Total tank capacity: 37 liters
- Pump tank: 8 liters
- Pump pressure: 2 bar
- Pump motor: 48 watts
- Weight: 17.6 kg
- Height: 77cm
- Width below: 40cm
- Width at the top: 36cm
- 
- Scope of delivery:
  - Power cable: 8.5 m
  - Suction hose: 2.5 m
  - Suction hose Ø: 40mm
  - Hose package including liquid hose
  - Fan jet nozzle with lever
  - Sponge filter
  - Anti-foam adapter
  - dust filter
  - operation manual



02

**Bristle nozzle**

For Normfest vacuum cleaner NT1200W item no. : 7983-010-1

▶ Item no. 7983-010-13

▶ Product description

- Ø 35 mm



03

**Suction hose**

For Normfest suction cups NT1200WSP item no. : 7983-011-1

▶ Item no. 7983-011-12

▶ Product description

- 40mm x 2.5m

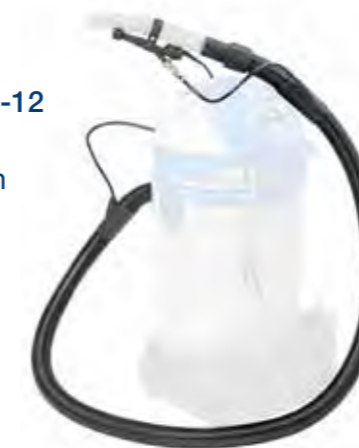

05

**Dust filter for NT1200WSP**

For Normfest suction cups NT1200WSP item no. : 7983-011-1

▶ Item no. 7983-011-15



07

**Anti-foam adapter**

For Normfest suction cups NT1200WSP item no. : 7983-011-1

▶ Item no. 7983-011-14



04

**Suction hose holder**

For Normfest suction cups NT1200WSP item no. : 7983-011-1

▶ Item no. 7983-011-11



06

**Sponge filters for liquids**

for NT1200W and NT1200SP

▶ Item no. 7983-010-16

▶ Product description

- For Normfest vacuum cleaner NT1200W item no. : 7983-010-1



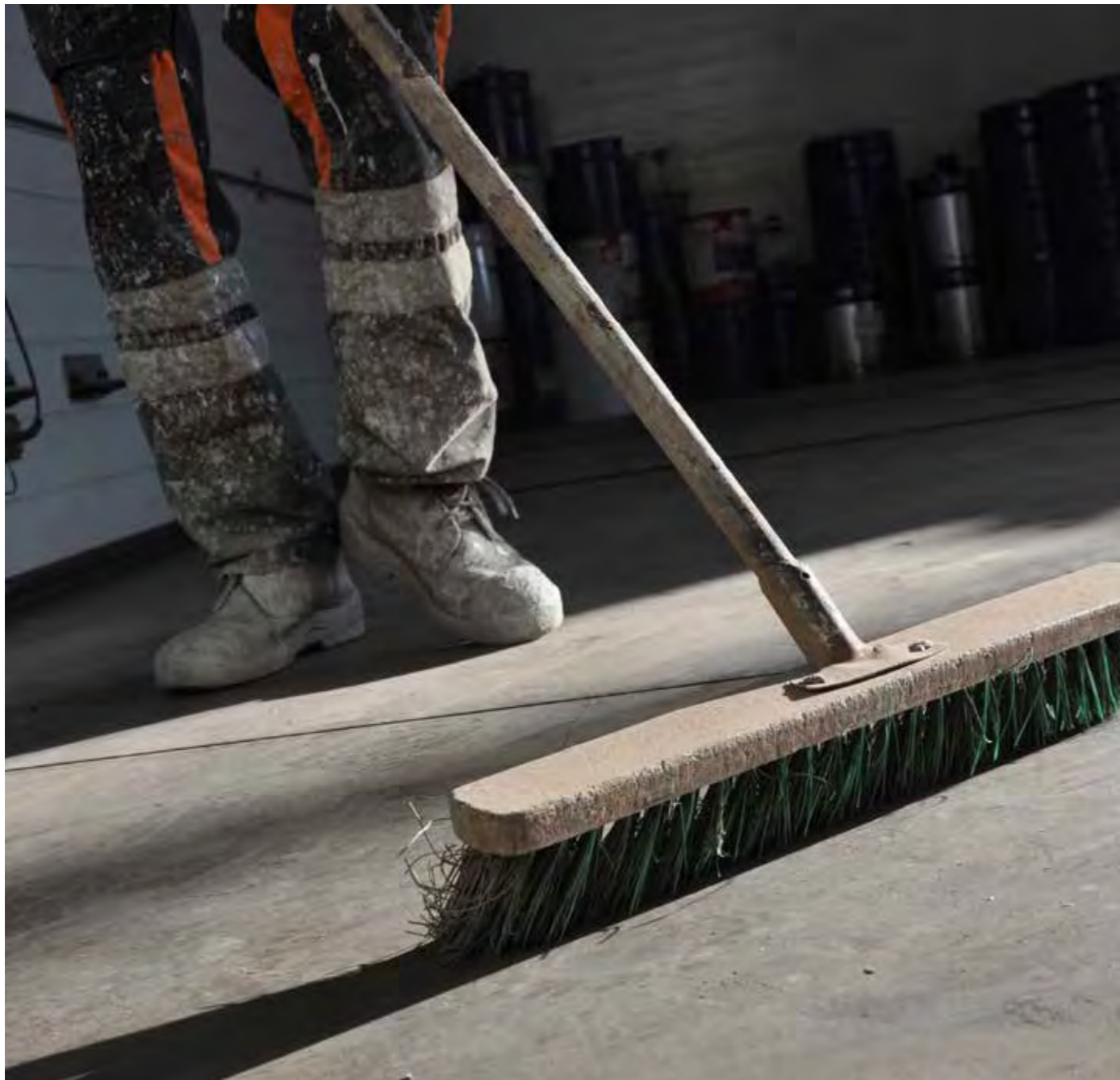

01

### Processing stalk

without water flow

► Item no. 2000-810-5

- Product description
- Dimensions: 31mm x 1500mm
  - Material: aluminum / PP
  - Temperature: 50 ° C



02

### Workshop broom

hard

► Item no. 2000-810-11

- Product description
- for sweeping wet and oily waste
  - Width: 440 mm
  - Body made of wood with a socket for handles with screw thread
  - with hard PVC bristles



03

### Bottom scraper

black

► Item no. 2000-810-12

- Product description
- Width: 600 mm
  - is great for removing water and oil
  - made of black polypropylene with an oil-resistant sheet made of cellular rubber



04

### trash bags

► Item no. 7875-908

- Product description
- 120 liters
  - 100 pieces per roll
  - 60 µm

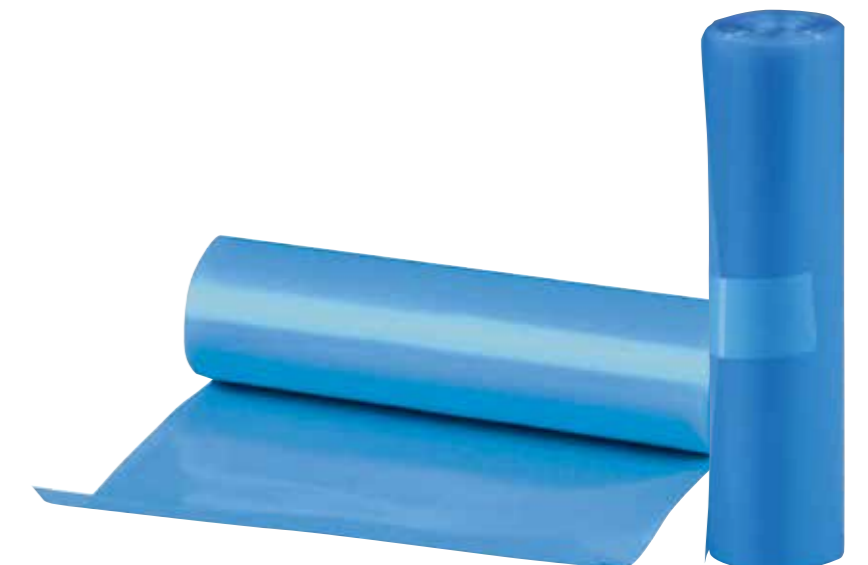



01

**Disposable protective covers Clean-Set**  
for passenger car

- ▶ Item no. 7410-003-009
- ▶ PU: 100

## ▶ Set consisting of:

- 1x seat protector 135 x 82cm, PE white
- 1x Footwell protector 38 x 50cm, film-coated paper, non-slip, waterproof
- 1x Steering wheel cover 40 cm, with elastic band, PE white
- 1x Gear lever cover with elastic band
- 1x handbrake protector without rubber band
- each set in a bag
- 100 sets per dispenser box



02

**Disposable protective covers as a compact 5in1 roll**  
recyclable

- ▶ Item no. 7875-919
- ▶ VPE: 1

## ▶ Technical specifications

- 100% recyclable
- Made from at least 50% recycled material
- 200 sets
- Set consisting of:
  - Slipcover
  - Doormat
  - Steering wheel protection
  - Gear lever protection
  - Handbrake protection



03

**Front protector**

- ▶ Item no. 7410-003-013

## ▶ Technical specifications

- All-round protection when working in the engine compartment
- with adjustable Velcro straps for attachment to the exterior mirrors
- With removable, non-slip, washable padding in the fender area
- Size variable through elastic band
- suitable for all common vehicle manufacturers
- large fold-out flaps that also securely cover large fenders



04

**Fender protector**  
made of polyester

- ▶ Item no. 7875-921-8

## ▶ Technical specifications

- with magnet
- 100 cm x 65 cm
- with two tool bags



05

**Fender protector**  
made of synthetic leather

- ▶ Item no. 7875-921-9

## ▶ Technical specifications

- with magnet
- 100 cm x 65 cm



01

**Disposable steering wheel protector**  
for passenger car

- ▶ Item no. 7410-003-014
- ▶ PU: 250

## ▶ Technical specifications

- For steering wheels with a maximum diameter of 40 cm
- with two rubber bands
- in the removal box
- 20 m $\mu$



02

**Disposable steering wheel protector**  
for trucks

- ▶ Item no. 7410-003-019
- ▶ PU: 250

## ▶ Technical specifications

- PE film with elastic band
- Diameter: 55 cm
- PU: 250 pieces
- Thickness: 20 $\mu$
- Color white



03

**Steering wheel protector roll**  
universal

- ▶ Item no. 7875-900

## ▶ Technical specifications

- Length: 300 m
- Width: 14 cm
- Inner core  $\varnothing$ : 3.8 cm



04

**Handle for steering wheel protector roll**

- ▶ Item no. 7875-900-01



05

**Disposable doormats**  
with NORMFEST logo

- ▶ Item no. 7875-510
- ▶ PU: 1
- ▶ Content: Roll each with 500 pcs.

## ▶ Technical specifications

- 38 x 50 cm
- 70g / m $^2$



06

**Duo-mat floor mats**  
universal

- ▶ Item no. 7875-511
- ▶ Content: 500 pcs. in a carton

## ▶ Technical specifications

- no seepage of liquids and oils
- high tear resistance thanks to the laminated, antistatic film
- 38 x 50 cm
- Paper: 70 g gray

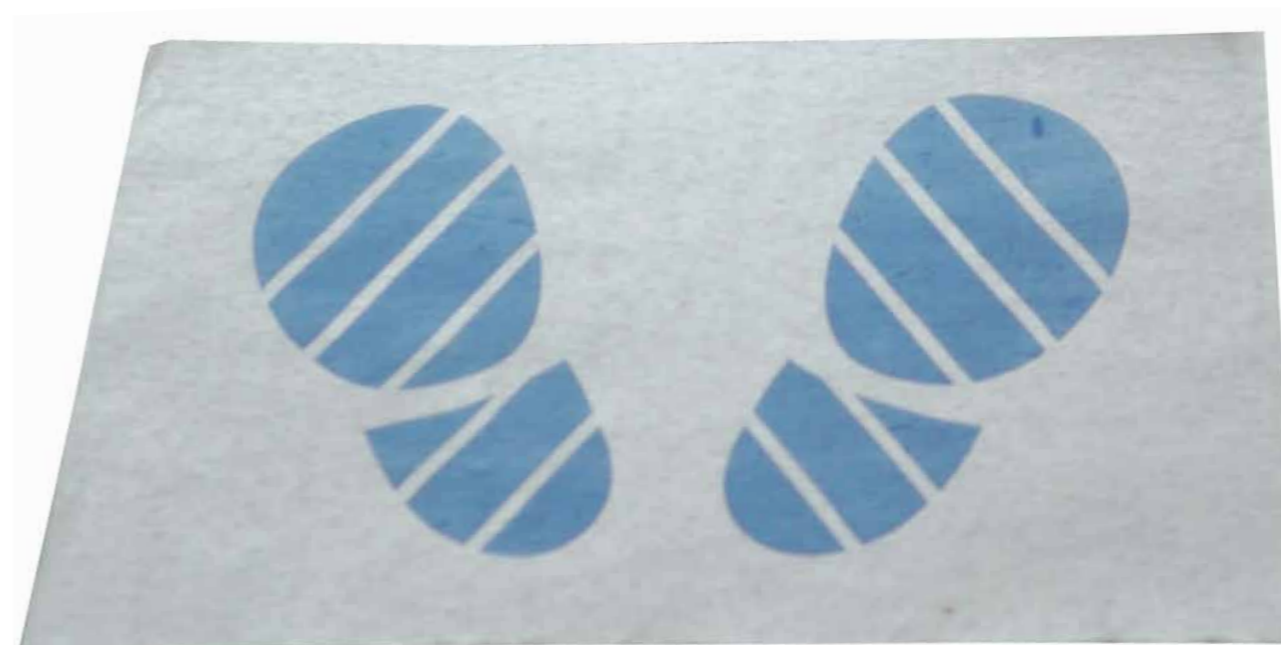



01

**Seat cover**

made of nylon

- ▶ Item no. 7875-920-1
- ▶ Technical specifications
  - 160 x 80 cm
  - Washable up to 50 ° C
  - 120 g per piece



02

**Seat cover**

made of synthetic leather

- ▶ Item no. 7875-920-000
- ▶ Technical specifications
  - approved for seats with airbag function
  - leatherette
  - Washable up to 40 ° C
  - Not suitable for light leather seats!



03

**Seat covers**

Color white

- ▶ Item no. 7875-904
- ▶ Content: Roll each with 100 pcs.
- ▶ Item no. 7875-902
- ▶ Content: Roll each with 500 pcs.
- ▶ Technical specifications
  - Dimensions: 82cm x 130cm
  - Thickness: 13μ
  - Roll of 100 pieces
  - perforated



04

**Seat covers**

permanently antistatic

- ▶ Item no. 7875-905
- ▶ Content: Roll each with 250 pcs.
- ▶ Technical specifications
  - Dimensions: 840 x 1400mm
  - Thickness: 17μ
  - 250 pieces per roll
  - permanently antistatic
  - approved for Daimler







01

**Order folders**► **Technical specifications**

- Format: approx. 230 x 330 mm
- Suitable for documents in DIN A4 format
- Including reinforced key compartment on the back side
- Very stable due to inner cardboard
- With pre-punched holes for possible hanging up



Item No.	execution	PU
7410-001-001	blue	10
7410-001-002	red	10
7410-001-003	black	10
7410-001-004	green	10
7410-001-005	yellow	10
7410-001-006	grey	10
7410-001-024	purple	10

02

**Premium order bag**► **Technical specifications**

- Format approx. 230mm x 330mm
- Sturdy and robust design for particularly long durability
- Welded transparent pocket on the front to hold the vehicle registration document
- On the back is an expansion pocket with extra large filling capacity (max. 30 mm) for service booklet and/or inspection records



Item No.	execution	PU
7410-001-017	red	10
7410-001-019	grey	10
7410-001-016	blue	10
7410-001-020	Snap hook including key ring	10



01

**Order folders**

with magnet and NF logo



Item No.	execution	PU
7410-001-025	blue	10
7410-001-026	black	10
7410-001-027	red	10

02

**Order folder security stickers**

## ► Item no. 7410-001-033

## ► Technical specifications

- for the protection of customer data
- are subsequently glued onto the order envelope
- can be cut to size
- self-adhesive
- cutting templates printed on reverse side
- printed
- Packaging unit: 10 per package



03

**Order bags**

with pixelated order field Technical specifications

- including key compartment made of fabric-reinforced foil
- Pixelation in the upper third
- firmly welded Velcro fastener
- extra robust design
- 330 x 230 mm
- PU: 10 pieces



Item No.	execution	PU
7410-001-021	blau	10
7410-001-022	red	10
7410-001-023	for 1001-179-6	10

04

**Clipboards**

## ► Technical specifications

- Format: approx. 230 x 330 mm
- Desk pad
- high quality finish
- with extra strong cardboard core
- durable clamping mechanism
- including extendable hook eye



Item No.	execution	PU
7410-001-007	black	12
7410-001-009	blue	12





01

**Speed sticker**

Note on the maximum permissible speed after changing wheels

► **Technical specifications**

- Speed sticker for the vehicle interior, for the customer information of the maximum permissible speed after changing wheels. lightfast, heat-resistant, can be removed without leaving any residue, in a practical cardboard dispenser box.
- Customer information for the vehicle interior
- can be removed without leaving any residue
- lightfast, heat-resistant
- in a practical cardboard dispenser box
- 25 mm diameter
- 100 pieces per roll

Item No.	execution	PU
7410-004-012	190 km/h	100
7410-004-013	210 km/h	100
7410-004-014	240 km/h	100



02

**Wheel bolt bag**► **Technical specifications**

- Wheel bolt bags made of 100% cotton
- with drawstring
- for the clever storage of wheel nuts with every tire change
- can be used several times
- Format: 170 x 200 mm
- PU = 100 pieces

Item No.	execution	PU
7410-003-004	Colour: natural	100
7410-003-003	Colour: black	100





01

**Loading clamps**► **Technical specifications**

- Length: 155 mm
- Maximum opening width: 40 mm
- weight: 170 g
- fully insulated sheet steel pliers
- screw connection for cable lugs via ring eyelet M6
- screws included



Item No.	colour	power	Application area
7771-16-200	red	200 A	Passenger cars
7771-16-201	black	200 A	Passenger cars
7771-35-600	red	600 A	commercial vehicle
7771-35-601	black	600 A	commercial vehicle

02

**Battery jumper cables**► **Technical specifications**

- narrow pliers head for confined space at the battery terminal
- flexible, pure copper cable
- high-quality polyamide pliers
- cables are supplied in a storage bag



Item No.	length	Ø / mm <sup>2</sup>
7771-16	3,0 m	16 for passenger car
7771-35	4,5 m	35 with overvoltage protection
7771-50	5,0 m	50 for NFZ

03

**Overvoltage protection**

for welding 12/24 volts

► **Item no. 4982-500**► **Technical specifications**

- for commercial vehicles and cars
- suppresses voltage peaks
- LED connection indicator
- no battery disconnection during welding
- no reprogramming of radio, clock, etc.
- considerable time savings







01

**Telwin Doctor Charge 50**

Multi-function electronic battery charger

► Item no. 7771-12-30

► Technical specifications

- "Pulse Tronic" automatic charging and trickle charging
- corresponds to the current-voltage characteristic (IUoU characteristic)
- Battery test, for example, to determine the voltage applied to the terminals or the starting power (CCA) as well as checking the vehicle's own
- Three-phase alternator for functionality
- Renewal and restoration of batteries, albeit deeply discharged
- On-board electronics protection when changing batteries, diagnostics and showroom mode
- Auxiliary start
- Effective charging current: 45 A conventional charging current (according to EU regulation): 40 A
- Length of power cable: 1.5m
- Length of charging cable: 3m



02

**Doctor Charge 50 connection cable**

Item No.	Length [m]	PU
7771-12-302	3	1
7771-12-303	6	1
7771-12-304	10	1



03

**Wall bracket**

for Telwin Doctor Charge 50

► Item no. 7771-12-301



04

**Bowl left**

for Telwin Doctor Charge 50

► Item no. 7771-12-306



05

**Bowl right**

for Telwin Doctor Charge 50

► Item no. 7771-12-305







**01**  
**Automatic battery charger**  
 T-Charge 12 EVO from Telwin

► Item no. 7771-6-12

- Technical specifications
- 6 / 12V automatic battery charger, maintenance charger and test device
  - suitable for all battery types
  - coordinated charging programs
  - Pulse Tronic
  - Impulse process for the repair of sulfated batteries
  - Test function for vehicle alternator and batteries
  - Supply function for power supply during battery change
  - Cold function for high-performance charging in freezing temperatures
  - User-friendly LCD display
  - has all protective functions
  - Protection against overload, short circuit and reverse polarity
  - Connection cable with charging clips



**02**  
**Battery trickle charger 12 / 24V**  
 Doctor Charge 130 230V from Telwin

► Item no. 7771-12-130

- Technical specifications
- automatic charging and trickle charging of the batteries
  - Repairing sulfated or severely discharged batteries
  - Regulated voltage source for battery changes, diagnostic activities or demonstration vehicles
  - Start of vehicles
  - Battery test



**03**  
**Wall bracket**

► Item no. 7771-12-131



**04**  
**Charging cable for Telwin Doctor Charge 130**



Item No.	Length [m]	PU
7771-12-132	6	1
7771-12-133	10	1



01

**Start booster**

Start Booster - car jump start device

▶ Item no. 7771-12

▶ Technical specifications

- including charger 12-220 V (1.5 A)
- NO pole protection
- Peak power: 2,200 amps
- Starting power: 700 Amp
- Capacity: 12 V 22 Ah
- Gel battery
- Copper cable: Ø 28 mm<sup>2</sup>
- fully insulated terminals
- protected against voltage peaks
- Cable length: 182 cm
- Weight: 8.3 kg



02

**Start Booster - jump start device for cars and trucks**

Car 12 V

▶ Item no. 7771-12-24

▶ Technical specifications

- including charger 12-220 V (4.0 A)
- WITH pole protection
- Voltage: 12 V or 24 V, choice of voltage via plug
- Peak power (SAE) 12 V / 24 V: 7,000 amps / 3,500 amps
- Starting power 12 V / 24 V: 2,300 amps / 1,150 amps
- Charger voltage: 230 V
- Charging: 12 V 4 A
- Battery life \*: 500 cycles (\* based on 50% discharge)
- Cable length: 182 cm
- Copper cable diameter: 50 mm<sup>2</sup>
- Number of built-in 500 A special batteries: 2
- fully insulated clamp
- protected against voltage peaks 2x 500 A fuse
- durable and shockproof ABS housing
- flexible cable with fully insulated, solid copper pliers
- with LED charge level tester



03

**charger**

for Start Booster 12V

▶ Item no. 7771-12-10



04

**Automatic charger**

for Start Booster 12V

▶ Item no. 7771-12-11



05

**Fuse for booster (Art.-No. 7771-12-24) FOR THE PLIERS FUSE, NEW VERSION**

12V and 24V

▶ Item no. 7771-12-14

▶ Technical specifications

- 500 AMP



06

**Battery 12V**

for Start Booster 12V

▶ Item no. 7771-12-12



07

**Battery 12V and 24V**

▶ Item no. 7771-12-13





01

### Cable drum with sturdy frame

► Item no. 7771-100

► Technical specifications

- for use outdoors (H07RN-F 3G1.5)
- Drum body made of robust, highly break-proof special plastic
- Shock-absorbing, stable, galvanized base
- ergonomically shaped handle
- Thermal protection switch with automatic function
- 3 socket outlets with safety flap and hammer sign
- suitable for construction site use
- 
- tested according to EN 61242
- Conform with BGI 608
- IP 44
- 230 V / 16 A
- Rolled up: 1000 W
- Unrolled: 3500 W
- Thermal protection: 1-pole / -56 ° C
- Temperature range: -15 to 50 ° C
- L / W / H: 280/190/380
- Weight: approx. 7.25 kg
- Body approx. Ø260 mm



02

### Automatic compressed air hose reel

► Item no. 8699-7

► Technical specifications

- impact-resistant and UV-resistant plastic housing
- Compressed air hose is designed for pressures up to 15 bar
- Length of compressed air hose: 10 m
- Ø compressed air hose: 8 mm
- Length of connection hose: 2 m
- swiveling wall bracket made of solid steel
- including compressed air fittings NW 7.2
- not suitable for permanent use in a painting booth



03

### Transmission jack hydraulic Load capacity: 300 kg

► Item no. 7714-300

► Technical specifications

- easy positioning
- Foot control
- high security
- versatile







01

**Inspection light ILF 200**

Including USB charging cable

▶ Item no. 7982-70-110

## ▶ Product description

- Main LED: 2 watt COB LED
- Additional LED: 3 watt SMD LED
- Luminous flux: 70-230 lm
- Burn time: 1.5-4h
- Protective functions: deep charge protection
- Battery pack: 3.7V Li-Po 700mAh
- Protection class: IP20
- Length: 173.9mm
- Lighting range: 10-25m
- 1 retaining clip on the back
- rotatable stand with magnet
- various switch functions



02

**Battery lamp set**

Including USB charging cable

▶ Item no. 7982-70-140

## ▶ Product description

- Power (lens / rod / flex): 5W / 6W / 1W
- Luminous flux: 300lm / 600lm / 80lm
- Battery life (full power): 3.5h / 2.0h / 10h
- Protection class: IP44 (assembled)
- Protective functions: deep discharge protection
- Housing material: aluminum
- Battery pack: 3.7V Li-Ion with 2,600 mAh
- 
- The right lamp for every application!
- 1 battery handle and 3 high quality lamp attachments
- 
- 1x battery handle incl. Li-ion battery (7982-70-141)
- Locking
- On / off switch
- Micro USB charging socket with rubber cover
- Charge and capacity display
- Integrated magnet
- Integrated hook can be rotated 360 °
- 
- 1x workshop light attachment Slim (7982-70-144)
- Rotary contact element to the base unit
- Swivel joint (swivels 180 ° / rotates 360 °)
- Work light
- Search light
- 
- 1x flashlight attachment (7982-70-143)
- Rotary contact element to the base unit
- Swivel joint (swivels 180 ° / rotates 360 °)
- Focusable lamp head
- 
- 1x inspection light attachment Flex (7982-70-142)
- Rotary contact element to the base unit
- Flexible lamp neck
- Focusable lamp head with integrated magnet
- 
- Scope of delivery:
- 1x USB charging cable
- 1x instruction manual
- 1x foam that fits into our case (item no. 1958-001)



01

**Battery handle**

Including Li-Ion battery

▶ Item no. 7982-70-141

▶ Product description

- Locking
- On / off switch
- Micro USB charging socket with rubber cover
- Charge and capacity display
- Integrated magnet
- Integrated hook can be rotated 360 °



02

**Inspection light attachment Flex**

for battery handle (Art.-No. 7982-70-141)

▶ Item no. 7982-70-142

▶ Product description

- Rotary contact element to the base unit
- Flexible lamp neck
- Focusable lamp head with integrated magnet



03

**Flashlight attachment**

for battery handle (Art.-No. 7982-70-141)

▶ Item no. 7982-70-143

▶ Product description

- Rotary contact element to the base unit
- Swivel joint (swivels 180 ° / rotates 360 °)
- Focusable lamp head



04

**Workshop light attachment Slim**

for battery handle (Art.-No. 7982-70-141)

▶ Item no. 7982-70-144

▶ Product description

- UV attachment
- 
- Main LED light source: 6W COB
- Color temperature: 6500K
- Switch function:
  - 1. Main LED at 100%
  - 2. Main LED at 50%
  - 3. UV LED
  - 4. Additional LED
  - 5. Off
- 
- Use:
  - e.g. when looking for a leak in the air conditioning system. (UV leak detection method)
- Rotary contact element to the base unit
- Swivel joint (swivels 180 ° / rotates 360 °)
- Work light
- Search light



05

**Workshop light attachment UV Slim**

for battery handle (Art.-No. 7982-70-141)

▶ Item no. 7982-70-145

▶ Product description

- Wide-angle illumination
- Main LED light source: 6W COB
- Colour temperature: 6500K
- Auxiliary LED: Point-focused
- Switch function:
  - 1. main LED at 100%
  - 2. main LED at 50%
  - 3. UV LED
  - 4. additional LED
  - 5. off
- Rotating contact element to base unit
- Swivel joint (180° swivelling / 360° rotatable)
- Working light
- Search light







01

**LED inspection light ILC 350**  
wired hand lamp

► Item no. 7982-70-100

► Product description

- LEDs: 12x 0.5W LEDs (6W)
- Luminous flux: 305 lm
- Lighting angle: wide angle
- Cable length: 5 meters
- Protection class: IP20 / IK07
- Weight: 550g
- Housing material: ABS



02

**Professional inspection light NF500R**  
incl. Micro USB charging cable

► Item no. 7982-70-60

► Product description

- robust plastic housing
- rubberized grip surface
- modern LED technology
- Effective lighting time: main light: approx. 2.5 h - additional light: approx. 5 h
- Charging time: approx. 3.5 hours
- 
- Mounting options for the lamp:
  - 360 ° rotatable hook on the top of the housing
  - Magnet on the back of the case
  - Incl. Micro USB charging cable 1.5m (optionally chargeable via USB AC charger or car adapter, not included in delivery)
- Weight: 190 g
- Dimensions: 280 x 40 x 27 mm





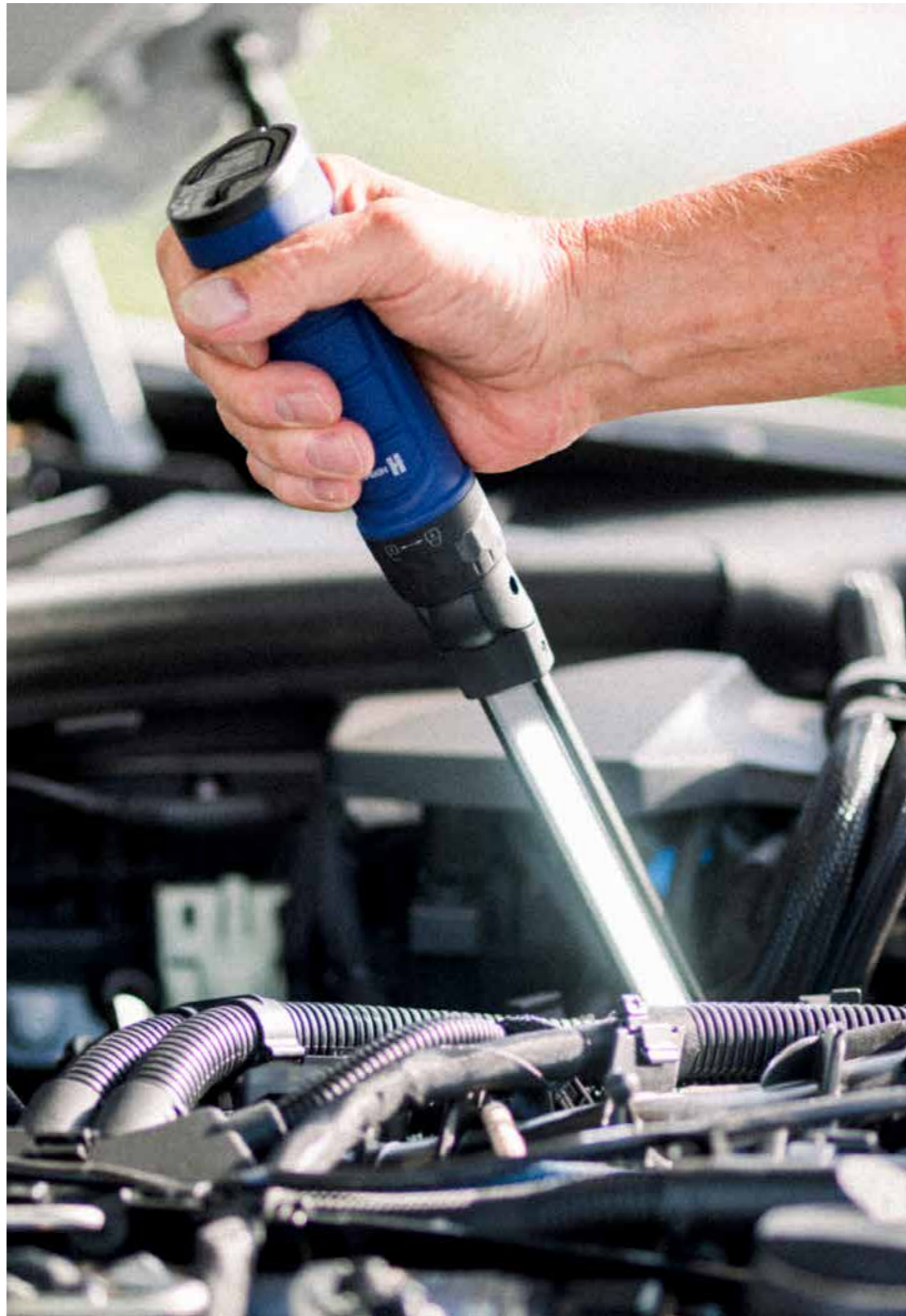

01

**Workshop light SL550**

Including USB charging cable

► Item no. 7982-70-10

## ► Product description

- robust and splash-proof plastic housing with rubberized grip surface
- Main light with two light functions (50% | 100% light output)
- Light intensity: 550 lumens
- Additional light on the lamp head
- Burn time: main light 100% 2.5 hours | 50% 5.5 hours
- Burn time: additional light 10 hours
- Attachment: holding magnet on the underside of the handle
- Additional functions: lamp handle can be rotated by 120 °, can be locked in 5 steps for flexible light alignment, battery control display via 3 green LEDs
- Battery: permanently installed Li-Ion battery pack (3.7V | 2600mA)
- Charging option: via micro USB socket, optionally via AC / DC power supply (110V-240V) or car adapter (12-24V)
- Scope of delivery: USB charging cable 150 cm, operating instructions
- Weight: 350 g
- Total length: 34 cm
- Length of LED lamps: 12 cm
- splash-proof IP 54





01

**Workshop lamp UL 200**

Including USB charging cable

► Item no. 7982-70-40

## ► Product description

- Additional light on the lamp head
- robust and splash-proof plastic housing
- 180 ° rotatable lamp handle, lockable in 7 steps for flexible light alignment
- Holding magnet on the underside of the handle and on the back of the lamp
- permanently installed Li-Ion battery pack (3.7V | 2600mA)
- Charging option via micro USB socket
- Charge control display via 1 green / red LED
- Switch on the back of the lamp
- Charging socket on the side of the lamp
- 360 ° foldable and rotatable retaining hook
- 
- Scope of delivery:
  - USB charging cable 250 cm
  - operation manual



02

**LED workshop light**

Including USB charging cable

► Item no. 7982-70-150

## ► Product description

- Main LED 600 lumens, 400 lumens at 40%
- Additional light 100 lumens
- incl. charging cradle with magnet
- robust and splash-proof plastic housing
- 180 ° rotatable joint with magnet
- Magnet on the back
- Fold-out hook, rotatable through 360 °
- Burn time: 100% - 1.5 hours / 40% - 4.5 hours / additional LED only - 10 hours
- Lighting range: 100% - 30m / 40% - 19m / only additional LED - 39m
- Max. illuminance: 100% - 907 Lux / 40% - 372 Lux / only additional LED - 1557 Lux
- Permanently installed Li-Ion battery pack (3.7V | 2600mA) with safety electronics
- Input socket: Micro USB with rubber cover
- Input current: 1000mA (max. 2000mA)
- Charging method: CCCV
- Charging time: approx. 4 hours
- Charge status display: Fully charged: green - Charging: red
- Charging cradle



03

**Workshop lamp mini Light ML220**

Including USB charging cable

► Item no. 7982-70-30

## ► Product description

- robust plastic housing with rubber grip surface
- Lamp bracket that can be rotated 340 ° and locked in twelve steps for flexible light alignment
- strong holding magnet on the underside of the lamp bracket
- Pull-out, 360 ° rotatable hook on the top of the housing
- integrated belt clip on the back of the case
- Luminaire with two light functions (100% / 50% light output)
- Permanently installed Li-Ion battery pack (3.7V / 1550mAh)
- Charging option via USB power supply (110V-240V) or USB car adapter (12-24V)
- Charging control display via colored LED on the back of the light
- Light output: 220 lumens
- 
- Scope of delivery:
  - USB charging cable 250 cm
  - operation manual







01

**LED mini floodlight BL700**

Including USB charging cable

▶ Item no. 7982-70-180

## ▶ Product description

- 7W COB LED main light source with three light levels (700 Lm / 350 Lm / 100 Lm)
- 3 W additional LED light source (100 Lm)
- Wide-angle illumination
- Width: 93.4 mm
- Depth: 37 mm
- Burn time: 2.5 hours - 12 hours depending on the intensity
- Largest projected area of the heater housing and its external parts: 75.2 m<sup>2</sup>
- dual energy supply
- 180 ° rotatable stand
- Handle with magnet
- Rubberized border
- Charge indicator
- with deep discharge protection
- Housing made of plastic
- Weight: 214 g (lamp with battery) 48 g (battery)
- Charging time: approx. 4 hours
- USB-C charging cable for quick charging
- Scope of delivery: lamp, USB type C charging cable, multilingual operating instructions



02

**Professional workshop light LED WL 440**

Including USB charging cable

▶ Item no. 7982-70-50

## ▶ Product description

- Lumens at 0.5m distance: main light: 440/280 lumens - additional light: 180 lumens
- Handle can be rotated by 180 °
- Lamp handle can be locked in eight steps
- robust and splash-proof plastic housing
- rubberized grip surface
- modern LED technology
- Effective lighting time: main light: up to 6 h - additional light: approx. 9 h
- Charging time: approx. 4 hours
- 
- Mounting options for the lamp:
  - 2x fold-out, 360 ° rotatable hooks
  - 2x holding magnets on the back
  - 1x magnet on the bottom
- Incl. Micro USB charging cable 1.5m (optionally chargeable via USB AC charger or car adapter, not included in delivery)
- Weight: 340 g
- Dimensions: 266 x 48 x 32 mm







01

**LED worklight UL500SP**

including speaker

▶ Item no. 7982-70-170

## ▶ Product description

- 5W COB LED main light source with two light levels (500 lm / 250 lm)
- 0.5 W additional LED light source (90 lm)
- Wide-angle illumination
- Length: 147 mm
- Burn time: 2 hours - 5 hours depending on the intensity
- Lighting range: 30 m to 42 m
- 2 magnets on the bottom
- Rubber hanging tab on the top
- Bluetooth speaker
- Fluorescent so that the lamp can be found in the dark
- Charge indicator
- with deep discharge protection
- Housing made of aluminum and plastic
- Weight: 190 g (lamp with battery) 35 g (battery)
- Charging time: approx. 2 hours
- Scope of delivery: lamp, USB charging cable, aluminum snap hook, multilingual operating instructions



02

**LED headlamp HL 260S**

Including USB charging cable

▶ Item no. 7982-70-90

## ▶ Product description

- Sensor and button function
- Control by gesture control
- adjustable head
- 2 light levels
- 260 lumens
- 110 lux
- shockproof
- splash-proof
- rubberized border
- Dimensions: 78.5 x 48 x 42 mm
- Weight: 110 g
- Burn time: up to 5.5 hours
- Charging time: 2.5 hours
- 
- Scope of delivery:
  - lamp
  - Headband
  - Micro USB cable
  - Multilingual instruction manual







01

**LED cordless construction spotlight BL1000**

Incl. AC power supply 1A with charging cable and holding magnet

► Item no. 7982-70-70

## ► Product description

- robust and splash-proof plastic housing with rubberized protective edge
- CRI function for detail and polishing work
- Luminaire with three light functions (20% / 45% / 100% light output)
- Light intensity: 1000 lumens
- Burn time: 9 hours
- Attachment: magnet, hole for tripod in the foot part
- Additional functions: Swiveling handle
- Battery: permanently installed Li-Ion battery pack (11.1V | 2200mA)
- Charging option: via the included AC power supply 1A
- Scope of delivery: AC power supply 1A, charging cable and magnet
- Weight: 720 g
- Dimensions: 209 x 190 x 73 mm
- Total diameter LED: 2 cm
- splash-proof IP 65



02

**BL 4000 cordless site spotlight**

Incl. AC power supply 1.5A with charging cable

► Item no. 7982-70-120

## ► Product description

- robust and splash-proof plastic housing with rubberized protective edge
- is used for large-area illumination of work areas indoors and outdoors
- Luminaire with three light functions (25% / 50% / 100% light output)
- Light intensity: 100% approx. 4000lm, 50% approx. 2000lm, 25% approx. 1000lm
- Burn time: 100% 1.5h, 50% 3h, 25% 6h
- Additional functions: Swiveling handle
- Battery: permanently installed Li-Ion battery pack (11.1V | 5200mA)
- Charging option: via the included AC power supply 1A
- Scope of delivery: AC power supply 1.5A, charging cable and magnet
- Weight: 1334g
- Dimensions: 237 x 266 x 59 mm
- splash-proof IP 65



03

**Telescopic holder Duo for BL series for BL series**

► Item no. 7982-70-003

## ► Product description

- Height: 1.73m
- Weight: 2900g
- Material: aluminum







01

**LED professional penlight PL20**

incl. 2 x AAA micro batteries

▶ Item no. 7982-70-80

▶ Product description

- modern LED technology
- Incl. 2x AAA batteries, wrist strap and belt clip
- Weight: 64 g (including batteries)
- Dimensions: 142 x 16 mm



02

**LED penlight**

Including USB charging cable

▶ Item no. 7982-70-160

▶ Product description

- 2W LED main light source with two light levels (200 lm / 100 lm)
- 1W additional lamp (100 lm)
- Wide-angle illumination
- Length: 164 mm
- Burn time: 1.5 hours - 2.5 hours depending on the intensity
- Lighting range: 13 m to 22 m
- Magnet on the bottom
- lateral retaining clip
- Charge indicator
- with deep discharge protection
- Housing made of aluminum and plastic
- Weight: 55 g (lamp with battery) 18.3 g (battery)
- Charging time: approx. 2 hours
- USB-C charging cable for quick charging
- Scope of delivery: lamp, USB type C charging cable, multilingual operating instructions



03

**Workshop lamp PL120**

Including USB charging cable

▶ Item no. 7982-70-20

▶ Product description

- robust and splash-proof plastic housing with rubberized grip surface
- small additional light on the lamp head
- Light intensity: 120 lumens
- Burn time: main light 3.5 hours
- Burn time: additional light 5 hours
- Attachment: retaining clip and magnet
- Battery: permanently installed Li-Ion battery pack (3.7V / 750mAh)
- Charging option: via micro USB socket, optionally via AC / DC power supply (110V-240V) or car adapter (12-24V)
- Scope of delivery: USB charging cable 150 cm, operating instructions
- Total length: 17 cm
- Length of LED lamps: 3 cm
- splash-proof





01

**LED inspection lamp**

Part of the screen repair case

▶ Item no. 3721-503

## ▶ Product description

- extra reinforced clip (break-proof)
- Housing made of aluminum
- Light source: 5 mm LED
- Length: 125 mm / ø head 12 mm
- including batteries (2x AAA, micro)
- constant light output
- with clip torque switching



02

**AC adapter USB**

for 230V sockets

▶ Item no. 7982-70-001

## ▶ Product description

- Input: 100-240V AC 50/60 HZ max.0.3A
- Output: 5V-max. 1000mA



03

**Charging plug USB**

for cigarette lighter

▶ Item no. 7982-70-002

## ▶ Product description

- Input: 12V / 24V - 550mA



04

**Flashlight**

for use in hazardous environments

▶ Item no. 7981-70-11

## ▶ Product description

- waterproof construction
- made of almost unbreakable polycarbonate glass
- intrinsically safe for use in hazardous environments
- shock and impact resistant polycarbonate housing
- Temperature resistant up to 135 °C
- Operating time: up to 50 hours
- Light source: high power LED
- Light intensity: 200 lumens (two brightness levels)
- Luminous flux: 200 lumens
- Beam range: 172m
- Protection class: Ex ia IIC T4 Ga
- Power supply: 4 AA batteries
- IP protection class: IP67
- Net weight: 214 g
- Dimensions: (LxHxW) 170 x 50 x 30 mm
- Weight: 0.21 kg







01

**MRL 1000 LED engine compartment light**

Including USB charging cable

▶ Item no. 7982-70-130

## ▶ Product description

- LEDs: 32x SMD LEDs
- Luminous flux: 500-1000 lm
- Burn time: 3-6h
- Protective functions: deep discharge protection
- Battery pack: Li-Ion 3.7V with 4,400 mAh
- Housing material: aluminum
- Protection class: IP65



02

**Work lamp for dent repair**

Including suction cup

▶ Item no. 8714-610

## ▶ Technical specifications

- flexible usage
- Can also be used as a hand lamp thanks to the removable flexible arm
- Paint-friendly suction cup with a diameter of 120 mm
- 300 mm long flex arm with cross handle
- Easy on the eyes thanks to the prismatic protective glass?
- 220/240 volts with automatic switch-off
- 50/60 Hz
- 900 lumens
- 210 mm light length
- Width: 38.5 mm
- Length: 65mm
- 11 watt fluorescent lamp
- 5m lead



01

**Packaging tape dispenser**  
with brake

▶ Item no. 4985-051

▶ Technical specifications

- for rolls up to 50 mm or 75 mm x 66 m



02

**Packaging tape**

▶ Technical specifications

- low-noise unwinding
- very high UV, ageing and temperature resistance for longer storage life
- can be used with all common hand dispensers

Item No.	Width (mm)	Length [m]	colour	PU
4985-049	50	66	brown	6
4985-050	50	66	transparent	6

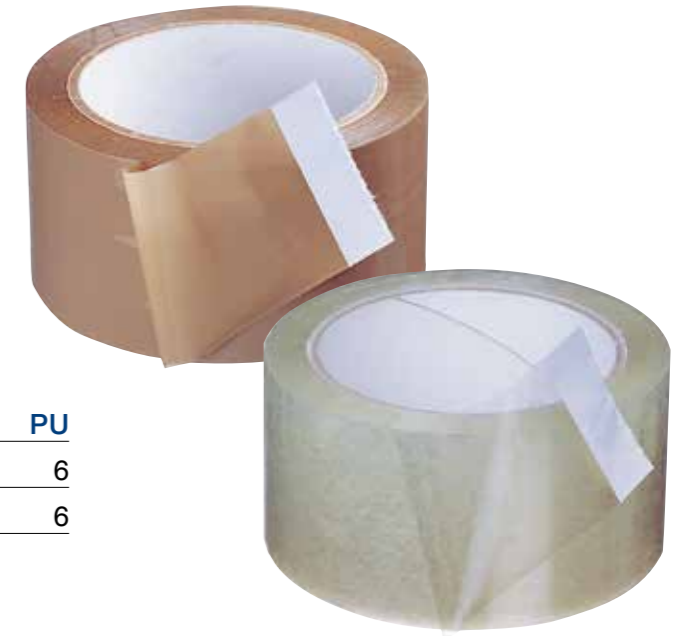

03

**Packaging tape - TESA packaging tape**

transparent, 66m x 50mm

▶ Item no. 4985-053

▶ Technical specifications

- quietly and evenly rolling
- very suitable for machine processing as well as for processing with all common hand dispensers
- problem-free manual and machine processing
- Universally applicable for closing medium-weight mailing boxes
- 
- PVC film carrier material
- Thickness 65 µm
- Natural rubber adhesive
- Bond strength on steel 2.2 N / cm
- Elongation at break 75%
- Tear force 47 N / cm



04

**Cutter knife**

▶ Item no. 7875-917-1

▶ Technical specifications

- for cutting paint protection films and masking paper





01

**Craft knife**

including a spare blade



## ► Technical specifications

- adjustable and exchangeable blade
- Blade mounted in a metal guide
- The blade can be locked

Item No.	execution	PU
600	Cutter knife	1
8715-57-601	Replacement blades	10
8715-57-606	Replacement blades, extra sharp	10

02

**Cutter knife narrow**

made of sheet steel



## ► Technical specifications

- Material: sheet steel
- Length: 13 cm
- Width: 1 cm
- Blade width: 0.9 cm

Item No.	execution	PU
8715-57-602	Replacement blades	1
8715-57-603	Replacement blades	10

03

**Safety knife**

Martor quality



## ► Technical specifications

- TÜV approved
- automatic blade retraction
- very good cutting properties
- universally applicable
- Handle made of high quality plastic
- The knife lies comfortably in the hand

Item No.	execution	PU
8715-57-604	Spare blades 10 pieces.	1
8715-57-605	Spare blades 10 pieces.	10

04

**Normfest Cutter Knife**

plastic



## ► Technical specifications

- sturdy plastic
- rubberised sheathing for a firm grip
- easy and safe replacement of the blade
- with one black blade

Item No.	execution	PU
7716-060-1	Normfest Cutter Knife Plastic	1
8715-57-606	Replacement blades, extra sharp	10

05

**Normfest Cutter Knife**

Heavy Duty



## ► Technical specifications

- made of full metal
- for tough use
- easy and safe replacement of the blade
- with a black blade

Item No.	execution	PU
7716-060-2	Normfest Cutter Knife Full Metal Heavy Duty	1
8715-57-606	Replacement blades, extra sharp	10

06

**Normfest - Safety cutter knife**

with spare blade trapezoid



## ► Technical specifications

- with 2 function levels
- automatic retraction when the blade is not in use
- lock for the permanently extended blade
- with one black trapezoid blade

Item No.	execution	PU
7716-060-3	Normfest safety cutter knife	1
8715-57-607	Replacement blade	10



05  
**RING BRUSH**  
with plastic frame



Item No.	size	Ø mm	PU
4693-02	2	15	1
4693-04	4	20	1
4693-06	6	25	1
4693-08	8	30	1
4693-010	10	35	1

06  
**brush**  
for tire fitting paste



Item No.	Ø mm	PU
4693-080-0	50	1

01  
**Flat brush**  
with unpainted handle



Item No.	size	PU
4693-1	1,0"	1
4693-15	1,5"	1
4693-2	2,0"	1

02  
**FLAT BRUSH**  
angled



Item No.	size	PU
4693-450-15	1,5"	1

03  
**brush**  
for body sealants



Item No.	size	PU
4693-251-1	1,0"	1

04  
**Soldering water brush**  
Handle made of tinned sheet metal



Item No.	size	PU
4693-500	25 mm	10

07  
**Touch-up brush**  
Size 8

- ▶ Item no. 4693-311-5
- ▶ Technical specifications
  - with seamless, round nickel ferrule
  - with red lacquered handle and gold-colored tip
  - Fine hair mixture
  - Cat's tongue shape
  - PU: 12 pieces



08  
**Paint roller**  
Contents: 5 rolls

- ▶ Item no. 4693-999
- ▶ Technical specifications
  - perfect, smooth surface of the primer - thanks to macopores
  - Width: about 10cm
  - Diameter: approx. 3 cm

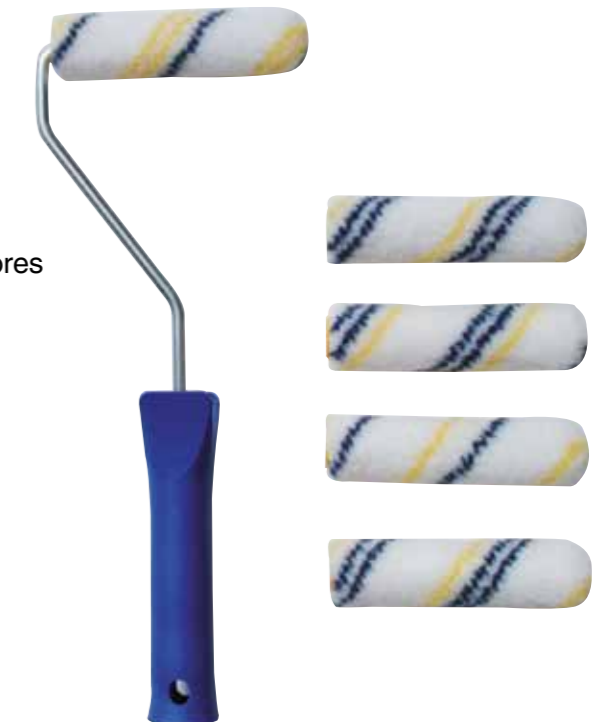



01  
**Brake calliper brush**  
Steel wire smooth 0.35, particularly hard brush



Item No.	execution	PU
8715-55-26	For steel callipers	1
8715-55-27	For aluminium callipers	1

02  
**Steel wire brushes**  
3-row steel wire 0.35 mm



Item No.	execution	PU
4697-3	3-row	1
4697-4	4-row	1
4697-5	5-row	1

03  
**Oil can**  
white / transparent, double-acting brass pump, 0.2 liters

- ▶ Item no. 7713-000
- ▶ Technical specifications
- Spray pipe, aluminum, bent



04  
**Funnel set**  
oil, acid and fuel resistant

- ▶ Item no. 2891-500-1
- ▶ Technical specifications
- oil, acid and fuel resistant
- versatile application possibilities
- with grip tab
- Ø 50-75-100-120 mm



05  
**Funnel with sieve**  
oil, acid and fuel resistant

- ▶ Item no. 2891-500-5
- ▶ Technical specifications
- with two-stage flexible spout, separable
- high overflow edge provides splash protection
- exchangeable fine sieve made of brass
- oil, acid and fuel resistant



06  
**measuring cup**  
oil and acid resistant



Item No.	content	PU
2891-300-1	1 litre	1
2891-300-2	2 litres	1
2891-300-5	5 litres	1

07  
**Measuring jug jug**  
oil and acid resistant



Item No.	execution	PU
2891-400-05	0.5 litre, colour: orange	1
2891-400-1	1 litre	1
2891-400-2	2 litres	1
2891-400-3	3 litres	1
2891-400-5	5 litres	1

08  
**Gooseneck**  
for measuring beakers with pouring tap



Item No.	execution	PU
2891-400-10	1 litre	1
2891-400-20	2 litres	1
2891-400-30	3 litres	1

01

**Pressure pump spray bottle**  
for acidic liquids

▶ Item no. 2897-333-100

## ▶ Technical specifications

- Operating pressure 3 bar
- unfilled
- Capacity 1 liter
- Labels available separately for better recognition
- Suitable replacement seal (optionally available): Article no. 2897-333-101?
- For filling with the following Normfest products:
- Bremtec brake cleaner

**Replacement seal**  
for acidic liquids

▶ Item no. 2897-333-101



02

**Pressure pump spray bottle**  
for Bremtec Safe

▶ Item no. 2897-333-170

## ▶ Technical specifications

- Operating pressure 3 bar
- unfilled
- Capacity 1 liter
- Labels available separately for better recognition
- including a replacement seal set (Item No. 2897-333-171)
- 
- For filling with the following Normfest product:
- Bremtec Safe brake cleaner

**Replacement seal**  
for Bremtec Safe bottle

▶ Item no. 2897-333-171



03

**Pressure pump spray bottle**  
for acid-free liquids

▶ Item no. 2000-100

## ▶ Technical specifications

- Capacity 1 liter
- Operating pressure 3 bar
- unfilled
- Suitable replacement seal (optionally available): Article no. 2000-101
- Labels for better recognition (optionally available): Article no. 1960-000 ...
- 
- For filling with the following Normfest products:
- Uni-Star universal cleaner
- All-Star Power Cleaner
- Interno interior intensive cleaner

**Replacement seal**  
for acid-free liquids

▶ Item no. 2000-101



04

**Pressure pump spray bottle**  
for acidic liquids

▶ Item no. 2897-333-150

## ▶ Technical specifications

- Capacity 1 liter
- Operating pressure 3 bar
- unfilled
- Matching replacement seal (optionally available): Item no. : 2897-333-151
- Labels for better recognition (optionally available): Article no. 1960-000 ...

**Replacement seal**  
for acidic liquids (Rimol Profi)

▶ Item no. 2897-333-151





01

**Pressure pump sprayer**

for all Normfest cleaners

▶ Item no. 2000-806

▶ Technical specifications

- Plastic container
- 4 bar operating pressure
- for detergents with a pH value of 1-7
- with liter scale
- chemically resistant Viton seals
- 1.5 m chemical-resistant spray hose
- 50 cm curved stainless steel spray tube
- Flat jet nozzle with nozzle head made of stainless steel, Ø 0.91 mm
- Pressure relief valve
- Compressed air connection
- integrated funnel
- Stainless steel revolver valve
- 
- Scope of delivery:
- container
- tube
- Spray tube
- Clasp
- WITHOUT shoulder strap
- WITHOUT hand pump to build up pressure



02

**Hand pump**

for pressure pump sprayer (Item No. 2000-806)

▶ Item no. 2000-806-1

▶ Technical specifications

- for Uni-Star, All-Star and Topas



03

**Replacement clasp**

for pressure pump sprayer (Item No. 2000-806)

▶ Item no. 2000-806-2



01

**Airpress filling station**

- ▶ Item no. 2897-910-100

▶ Technical specifications

- universal use in many industrial sectors
- there is no need to buy any spray
- no disposal costs
- no environmental pollution from the use of air as a propellant



02

**Airspray pressure bottle for Bremtec A2**

- ▶ Item no. 2897-910-1
- ▶ Content: 400 ml
- ▶ PU: 1



03

**Airspray pressure bottle for Bremtec**

- ▶ Item no. 2897-910-2
- ▶ Content: 400 ml
- ▶ PU: 1



04

**Airspray pressure bottle for oxime**

- ▶ Item no. 2897-910-3
- ▶ Content: 400 ml
- ▶ PU: 1



**Material air valve**

- ▶ Item no. 2897-910-103
- ▶ PU: 1



**Air valve**

- ▶ Item no. 2897-910-104
- ▶ PU: 1



**Seal holder with groove ring**

- ▶ Item no. 2897-910-105
- ▶ PU: 1



**Plug nipple with external thread 1/4 "**

- ▶ Item no. 8699-25-531
- ▶ PU: 1



**Spare part material / air**

- ▶ Item no. 2897-910-106
- ▶ PU: 1



**Seal kit for the Air Press filling station**

- ▶ Item no. 2897-910-107
- ▶ PU: 1



**Barrel connection including accessories for 60 liters**

- ▶ Item no. 2897-910-110
- ▶ PU: 1



**Valve with riser pipe**

- ▶ Item no. 2897-910-101
- ▶ PU: 1



**Spray head with round jet**

- ▶ Item no. 2897-910-102
- ▶ PU: 1



**Spray head with point jet**

- ▶ Item no. 2897-910-108
- ▶ PU: 1





01

### Dosing system for canister goods 14 liter variant

- ▶ Item no. 2000-430
- ▶ Technical specifications
- for the dosed dilution of chemicals and cleaning agents with water
- Permanently constant mixing ratio (14 possibilities), therefore no waste of the product / no incorrect mixes / no spillage
- simple and space-saving installation / assembly
- simple and user-friendly operation and maintenance
- Considerable time savings when dosing or when filling containers
- Amortization of the acquisition costs over a longer period of time
- innovative technology and robust and hard-wearing design (housing material PP)
- modularly expandable by adding additional dosing systems one behind the other and next to one another.
- No additional electricity or compressed air connection required, just a water connection (even with several dosing systems next to each other)
- Removal of several cleaners at a central and defined location
- Backflow preventer to avoid chemical contamination of the tap water
- Suitable for chemicals between a pH value of 4-10



Essentially, it is about mixing our 30 liter canisters in the correct mixing ratio, as well as filling containers safely and efficiently for further processing.

Who of you is not familiar with the fact that it is not so easy to find the right mixing ratio for e.g. the hall floor cleaner „Bio Star Protect“ or „All Star“ by hand. If the mixture is dosed too concentrated, the cleaning result is often streaky, if the customer doses it too weakly, the cleaning result is unsatisfactory. We don't even want to talk about wasted products and money at this point.

This is exactly what our new dosing system is used for.

The mixing system works completely without electricity, it is connected to the fresh water connection and to a canister of cleaner, regardless of whether it is 5L or 30L, and the dosing system then mixes the preset mixing ratio at the push of a button.

You have the option of filling the finished mixture into a container such as a watering can via a filling hose.

14 different mixing ratios are possible for pre-setting the mixing system. By using different metering fittings in the suction line, you can set the desired mixing ratio.

It is also possible to connect several mixing systems one behind the other, you can find details in the operating instructions.

#### Power cleaner, degreaser, universal cleaner All Star Protect

- ▶ Item no. 2000-318-30
- ▶ Content: 30 litre



#### Universal workshop cleaner Bio Star Extreme

- ▶ Item no. 2897-270-30
- ▶ Content: 30 liters



#### Universal cleaner, power cleaner Uni-Star

- ▶ Item no. 2000-02-30
- ▶ Content: 30 litre



#### Gloss shampoo Wash

- ▶ Item no. 2000-300-30
- ▶ Content: 30 litre



#### Power cleaner concentrate, universal cleaner All-star

- ▶ Item no. 2000-312-30
- ▶ Content: 30 litre



#### Tarpaulin cleaner concentrate Cover star

- ▶ Item no. 2000-313-30
- ▶ Content: 30 litre



#### Car shampoo Wash

- ▶ Item no. 2000-321-30
- ▶ Content: 30 litre





# AQUANO TOUCHLESS

01

## skin protection Aquano Protect

- ▶ Item no. 2897-500-201
- ▶ Content: 1 litre
- ▶ Quantity per box: 6

### ▶ Technical specifications

- protects the skin when handling aqueous and non-aqueous substances such as cooling lubricants, diluted acids, alkalis, oils, fats, tar, paints, adhesives, etc.
- fast moving
- non-greasy
- PH-level neutral
- silicone free
- dermatologically tested
- suitable for allergy sufferers



02

## Hand cleaning lotion Aquano Soft

- ▶ Item no. 2897-500-23
- ▶ Content: 1 litre
- ▶ Quantity per box: 6

### ▶ Technical specifications

- does not contain abrasives
- for dust and light soiling
- Viscosity of soap
- pH value: 7
- dermatologically tested
- particularly skin-friendly
- high quality ingredients
- increased lipid replenishment of the skin
- especially suitable for sensitive skin
- suitable for frequent washing



03

## Foam soap Aquano foam

- ▶ Item no. 2897-500-25
- ▶ Content: 1 litre
- ▶ Quantity per box: 6

### ▶ Technical specifications

- gentle on the skin thanks to sugar surfactants and glycerine
- suitable for hand and body cleaning
- aqueous solution
- fine, bubbly, creamy foam
- scented
- pH skin neutral
- silicone free





01

**Hand cleanser**

Aquano Sens

- ▶ Item no. 2897-500-240
- ▶ Content: 1 litre
- ▶ Quantity per box: 6
  
- ▶ Technical specifications
  - suitable for particularly sensitive skin
  - for dust, dirt, oils, greases, brake dust, other light to medium soiling
  - dermatologically tested
  - pH: 4.7-5.5
  - cleans the pores
  - with sustainable skin protection
  - adequate replenishment
  - silicone-



03

**Skin care**

Aquano lotion

- ▶ Item no. 2897-500-22
- ▶ Content: 1 litre
- ▶ Quantity per box: 6
  
- ▶ Technical specifications
  - promotes the regeneration of damaged skin areas
  - suitable for the whole body
  - with natural oils and vitamin E.
  - not moisturizing
  - PH-level neutral
  - weakly perfumed
  - silicone free
  - dermatologically tested
  - suitable for allergy sufferers



02

**Hand cleanser**

Aquano peel

- ▶ Item no. 2897-500-21
- ▶ Content: 1 litre
- ▶ Quantity per box: 6
  
- ▶ Technical specifications
  - Grating agent: walnut shell flour
  - for dust, dirt, oils, fats, brake dust, other light to medium soiling
  - Medium viscosity paste
  - pH value: 4.8 - 5.5
  - also suitable for sensitive skin
  - free from microplastics
  - good refatting
  - dermatologically tested and suitable for allergy sufferers
  - does not clog drains
  - silicone free
  - Odor: orange / lemongrass
  - dermatologically tested - ECO label



04

**Disinfectant gel**

Aquano

- ▶ Item no. 2897-500-20
- ▶ Content: 1 litre
- ▶ Quantity per box: 6
  
- ▶ Technical specifications
  - Fingerprints on objects are reduced
  - has a disinfecting effect
  - free from preservatives and fragrances
  - silicone free
  - dermatologically tested
  - DGHM / VAH listed



01

**Plastic dispenser system**

Aquano touchless

► Item no. 2897-500-26

► Technical specifications

- W 108 x H 312 x D 100 mm
- for 1 liter bottles
- electronic operation
- 4x mono VARTA high-energy batteries included

02

**Plastic dispenser system**

for 1 liter container

► Item no. 2897-500-27

► Technical specifications

- W 108 x H 312 x D 100 mm
- for 1 L bottles
- manual mode

03

**Promotion set Aquano touchless**

4 parts

► Item no. 2897-500-002

► Contents:

- 6 x Rod mixer square blue (art. no. 2700-42)
- 2 x AQUANO touchless dispensers for 1 liter containers
- 1 x AQUANO FOAM foam soap 1 liter
- 1 x AQUANO disinfectant gel 1 liter



electronic



manual



vhodné pro:





# AQUANO



01

## skin protection Aquano Protect

- ▶ Item no. 2897-500-2
- ▶ Content: 2 litres
- ▶ Quantity per box: 6
  
- ▶ Item no. 2897-500-225
- ▶ Content: 250 ml
- ▶ Quantity per box: 12

- ▶ Technical specifications
  - protects the skin when handling aqueous and non-aqueous substances such as cooling lubricants, diluted acids, alkalis, oils, fats, tar, paints, adhesives, etc.
  - fast moving
  - non-greasy
  - PH-level neutral
  - silicone free
  - dermatologically tested
  - suitable for allergy sufferers



02

## Extreme skin protection Aquano Protect Plus

- ▶ Item no. 2897-500-825
- ▶ Content: 250 ml
- ▶ Quantity per box: 12

- ▶ Technical specifications
  - for strongly adhesive, non-aqueous working materials such as e.g. Oils, lacquers, bitumen, adhesives, resins, PU foams, etc.
  - fast moving
  - non-greasy
  - PH-level neutral
  - silicone free
  - dermatologically tested
  - suitable for allergy sufferers



03

## Hand cleanser Aquano Sens

- ▶ Item no. 2897-500-01
- ▶ Content: 2 litres
- ▶ Quantity per box: 6
  
- ▶ Item no. 2897-500-126
- ▶ Content: Size 10
- ▶ Quantity per box: 12

- ▶ Technical specifications
  - suitable for particularly sensitive skin
  - for dust, dirt, oils, greases, brake dust, other light to medium soiling
  - dermatologically tested
  - pH: 4.7-5.5
  - cleans the pores
  - with sustainable skin protection
  - adequate replenishment
  - silicone-





01

**Hand washing paste**

Aquano Corn

- ▶ Item no. 2897-500-12
- ▶ Content: 2 litres
- ▶ Quantity per box: 6

▶ **Technical specifications**

- Cleaning level 5 of 8
- Grating agent: corn on the cob meal
- for dust, dirt, oils, greases, brake dust, other light to medium soiling
- Medium viscosity paste
- pH value: 7
- dermatologically tested
- 
- for medium to heavy soiling
- dermatologically tested and suitable for allergy sufferers
- good refatting
- does not clog drains
- suitable for different dispenser systems
- Natural abrasive maize flour that is ecologically biodegradable without leaving any residue
- good value for money
- silicone free



02

**Hand cleanser**

Aquano peel

- ▶ Item no. 2897-500-10
- ▶ Content: 2 litres
- ▶ Quantity per box: 6

▶ **Technical specifications**

- Cleaning level 6 of 8
- Grating agent: walnut shell flour
- for dust, dirt, oils, greases, brake dust, other light to medium soiling
- Medium viscosity paste
- pH value: 4.8 - 5.5
- dermatologically tested - ECO label
- also suitable for sensitive skin
- free from microplastics
- environmentally friendly
- good refatting
- dermatologically tested and suitable for allergy sufferers
- does not clog drains
- silicone free
- Color: light brown
- Odor: orange / lemongrass



03

**Special hand cleaner**

Aquano Peel Special

- ▶ Item no. 2897-500-11
- ▶ Content: 2 litres
- ▶ Quantity per box: 6

▶ **Technical specifications**

- Cleaning level 8 of 8
- Grating agent: walnut shell flour
- Solvent
- for dust, dirt, oils, greases, brake dust, paints, other light, medium to heavy soiling
- Medium viscosity paste
- pH value: 7
- dermatologically tested
- suitable for allergy sufferers
- suitable for different dispenser systems
- contains environmentally friendly and skin-friendly ester oils to aid cleaning
- the natural abrasives do not clog drains
- contains natural and synthetic refatting substances
- silicone free
- Color: dark beige
- Density: approx. 1.05 g / cm<sup>3</sup> (20 ° C)
- Smell: fruity - orange / lemongrass





01

**Skin care lotion**

Aquano lotion

- ▶ Item no. 2897-500-3
- ▶ Content: 2 litres
- ▶ Quantity per box: 6

- ▶ Item no. 2897-500-325
- ▶ Content: 250 ml
- ▶ Quantity per box: 12

▶ **Technical specifications**

- promotes the regeneration of damaged skin areas
- suitable for the whole body
- with natural oils and vitamin E.
- not moisturizing
- PH-level neutral
- weakly perfumed
- silicone free
- dermatologically tested
- suitable for allergy sufferers



03

**Donor**

for 2 liter soft bottles

- ▶ Item no. 2897-500-6

▶ **Technical specifications**

- 1 x system dispenser
- 4 x 6mm dowels, stainless steel screws and washers
- 1 x key
- 1 x rotating head
- 1 x dosing piece
- 1 x assembly and operating manual



suitable for:



02

**Disinfectant gel**

Aquano

- ▶ Item no. 2897-500-13
- ▶ Content: 2 liters
- ▶ Quantity per box: 6

▶ **Technical specifications**

- Fingerprints on objects are reduced
- has a disinfecting effect
- free from preservatives and fragrances
- silicone free
- dermatologically tested
- DGHM / VAH listed



04

**Liquid hand disinfection**

- ▶ Item no. 0000-500-5
- ▶ Content: Uni-Star
- ▶ PU: 1

▶ **Item no. 0000-500-500**

- ▶ Content: Aquano
- ▶ Quantity per box: 6

▶ **Technical specifications**

- Recognized WHO formula: 75% alcohol v / v: corresponds to 100% of the WHO hand hygiene formula.
- Kills over 99.9% of viruses, bacteria and germs on hands.
- No water required: quick drying - no sticky residue.
- Concept's liquid hand disinfectant is made from the WHO-recommended formula to fight the spread of the coronavirus (Covid 19). Propan-2-Ol is effective against enveloped viruses if the solution is over 70%. The coronavirus is an enveloped virus.
- Areas of application: suitable for use in the workplace, in nursing homes, hospitals, schools, kitchens, food processing, funeral homes, offices, sports facilities, industrial plants, etc.



# CARE



01

## Skin protection lotion Care Protect

- ▶ Item no. 2897-240-1
- ▶ Content: 1 litre
- ▶ Quantity per box: 10

- ▶ Technical specifications
  - lies on the skin like an invisible protective glove
  - protects the skin when handling different working materials such as cooling lubricants, diluted acids, alkalis, oils, fats, tar, bitumen, and much more.
  - silicone free
  - pH skin neutral
  - dermatologically tested
  - non-greasy



02

## Skin cleansing lotion Care Soft

- ▶ Item no. 2897-240-3
- ▶ Content: 1 litre
- ▶ Quantity per box: 10

- ▶ Technical specifications
  - Cleaning level 1 of 8
  - does not contain abrasives
  - for dust and light soiling
  - Viscosity of soap
  - pH value: 7
  - dermatologically tested
  - particularly skin-friendly
  - high quality ingredients
  - increased lipid replenishment of the skin
  - especially suitable for sensitive skin
  - suitable for frequent washing



03

## Skin care Care lotion

- ▶ Item no. 2897-240-2
- ▶ Content: 1 litre
- ▶ Quantity per box: 10

- ▶ Technical specifications
  - slightly greasy skin care lotion
  - can be easily spread on the skin
  - moves in very quickly
  - promotes the regeneration of damaged skin areas
  - silicone free
  - pH skin neutral
  - dermatologically tested





01

**Hand washing paste**

Hand cleaner

- ▶ Item no. 2897-240-8
- ▶ Content: 10 kg jumbo pail
  
- ▶ Technical specifications
  - Cleaning level 2 of 8
  - Grinding agent: wood flour
  - removes oils, fats and other light to medium dirt
  - Viscosity pasty
  - pH value: 5.6-5.8
  - dermatologically tested
  - silicone free
  - alkali free



02

**Hand cleanser**

Care Clean Corn

- ▶ Item no. 2897-240-0
- ▶ Content: 3 liters
- ▶ Quantity per box: 6
  
- ▶ Item no. 2897-240-011
- ▶ Content: 1 litre
- ▶ Quantity per box: 10
  
- ▶ Technical specifications
  - effectively removes heavy soiling such as oils, fats, dusts, etc.
  - cleans the pores
  - with a lasting protective effect
  - balanced refatting
  - silicone and solvent free
  - dermatologically tested
  - pH 5.6-5.8
  - Grating agent: finely ground corncob meal
  - it is a waste product, so there is no competition with food
  - Corn on the cob meal won't clog drains



03

**Hand cleaning cream**

Care Truck

- ▶ Item no. 2897-240-9
- ▶ Content: 3 liters
- ▶ Quantity per box: 6
  
- ▶ Technical specifications
  - Cleans soiled skin powerfully, pore-deep and gentle on the skin
  - effectively removes stubborn dirt such as oils, greases, lubricants, resins, bitumen, soot, synthetic resin, nitro and gravure inks, etc.
  - with shea butter for very good moisturizing
  - cleans extremely dirty skin pore-deep and gentle on the skin
  - silicone-free and dermatologically rated „very good“
  - without mineral oils
  - fresh scent of orange
  - Grating: Corn on the cob and walnut shell flour



01

**Skin protection plan**

Product overview for correct use

► Item no. 2897-500-71

► Technical specifications

- A good skin protection organization also includes information on the question of which specific protective measures are recommended for skin cleansing and care at the workplace. For this purpose, we have created a skin protection plan for you and your employees with our products.
- The plan is printed on a thin PVC foam board so that it can be hung up next to the washing area.

**SKIN PROTECTION PLAN**  
The right product for every application

**PROTECTION**

- Care Protect Art-Nr.: 2897-240-1 • Content: 1 l
- Aquano Protect Art-Nr.: 2897-500-225 • Content: 250 ml
- Art-Nr.: 2897-500-2 • Content: 2 l
- Aquano Protect Plus Art-Nr.: 2897-500-825 • Content: 250 ml

**CLEANING SOILING**

light	medium	heavy
light soiling e.g. dust	other light soiling e.g. dust, dirt, oils, greases, brake dust	other light to medium soiling e.g. dust, dirt, oils, greases, brake dust
other medium soiling e.g. dust, dirt, oils, greases, brake dust	other medium to heavy Contamination e.g. dust, dirt, oils, greases, brake dust, varnish	other heavy soiling e.g. dust, dirt, oils, grease, brake dust, paintwork
Care Soft Art-Nr.: 2897-240-3 • Content: 1 l	Hand wash paste Art-Nr.: 2897-240-8 • Content: 10 l	Care Clean Corn Art-Nr.: 2897-240-011 • Content: 1 l
Aquano Soft Art-Nr.: 2897-500-23 • Content: 1 l	Aquano Peel Art-Nr.: 2897-500-21 • Content: 1 l	Aquano Peel Spezial Art-Nr.: 2897-500-11 • Content: 2 l
Aquano Foam Art-Nr.: 2897-500-25 • Content: 1 l	Care Clean Corn Art-Nr.: 2897-240-0 • Content: 3 l	Care Truck Art-Nr.: 2897-240-9 • Content: 3 l
	Aquano Sense Art-Nr.: 2897-500-126 • Content: 250 ml	Aquano Corn Art-Nr.: 2897-500-12 • Content: 2 l
	Art-Nr.: 2897-500-240 • Content: 1 l	
	Art-Nr.: 2897-500-01 • Content: 2 l	

**DISINFECTION**

- Aquano Disinfection gel Art-Nr.: 2897-500-13 • Content: 2 l
- Art-Nr.: 2897-500-20 • Content: 1 l

**CARE**

- Care Lotion Art-Nr.: 2897-240-2 • Content: 1 l
- Aquano Lotion Art-Nr.: 2897-500-325 • Content: 250 ml
- Art-Nr.: 2897-500-22 • Content: 1 l
- Art-Nr.: 2897-500-3 • Content: 2 l

Normfest GmbH  
Normfeststraße 23 • 42551 Velbert  
Tel. +49 20 51 / 275-0  
Fax +49 20 51 / 275-141

02

**Promotion Set Aquano 2020**

7 pieces

► Item no. 2897-500-003

► Contents:

- 6 x Rod mixer square blue (art. no. 2700-42) 3 x dispensers AQUANO for 2 liter soft bottles
- 1 x AQUANO Sens hand washing paste 2 liters
- 1 x AQUANO Protect skin protection 2 liters
- 1 x AQUANO lotion skin care 2 liters
- 1 x skin protection plan





01

**Donor Care**  
for Care-Soft

- ▶ Item no. 2897-240-4
- ▶ Technical specifications
  - a dispenser unit for the? Care Soft 1 liter bottle? (2897-240-3)

suitable for:



04

**Wall bracket Care**  
for 1 liter bottle

- ▶ Item no. 2897-240-5
- ▶ Technical specifications
  - suitable for items 2897-240-1, 2897-240-3 and 2897-240-2

suitable for:



02

**Donor**  
for 1 liter bottle

- ▶ Item no. 2897-240-6
- ▶ Technical specifications
  - Dispenser for Care 1 liter bottles
  - suitable for items 2897-240-3, 2897-240-1 and 2897-240-2

suitable for:



05

**Care wall mount**  
for the complete system

- ▶ Item no. 2897-240-15
- ▶ Technical specifications
  - for Care Protect and Care Lotion (1 liter bottles)
  - for Care Clean (3 liter bucket)

suitable for:



03

**Donor Care**  
for 3 liter buckets

- ▶ Item no. 2897-240-7
- ▶ Technical specifications
  - Dispenser for Care Clean 3 liter buckets
  - suitable for article no. 2897-240

suitable for:



06

**Wall bracket and dispenser**  
Care

- ▶ Item no. 2897-240-10
- ▶ Technical specifications
  - Wall bracket with integrated dispenser for the Care Clean 3 liter bucket
  - suitable for article no. 2897-240

suitable for:



# SHOWROOM SERIE



01

## Garbage can White

- ▶ Item no. 2897-600-4
- ▶ Technical specifications  
- 490 x 220 x 330 mm



02

## White touchless dispenser for foam soap for foam soap

- ▶ Item no. 2897-600-9
- ▶ Technical specifications  
- 270 x 140 x 130 mm  
- 0.5 litre capacity

### Foam soap

for dispenser (art. no. 2897-600-1 and -9)

- ▶ Item no. 2897-600-5
- ▶ Content: 500 ml
- ▶ Quantity per box: 6



electronic



03

## Donor for foam soap

- ▶ Item no. 2897-600-1
- ▶ Technical specifications  
- 232 x 114 x 124 mm

### Foam soap

for dispenser (art. no. 2897-600-1 and -9)

- ▶ Item no. 2897-600-5
- ▶ Content: 500 ml
- ▶ Quantity per box: 6



manual





01

**Automatic dispenser for paper rolls**

White

▶ Item no. 2897-600-3

▶ Technical specifications

- 371 x 221 x 330 mm
- 4 x mono batteries are required (item no. 3722-01)
- Matching paper roll: 205 x 152 mm (Item No. 2897-600-7)

electronic



03

**Dispenser for folding paper**

White

▶ Item no. 2897-600-2

▶ Technical specifications

- 345 x 112 x 306 mm

manual



02

**Paper roll**

for automatic dispenser (Item No. 2897-600-3 / 31)

▶ Item no. 2897-600-7

▶ Content: 400 sheets per roll

▶ Quantity per box: 6

▶ Technical specifications

- 2-ply
- 6 rolls of 400 sheets per box
- Sheet size: 380 x 205 mm
- Packaging dimensions: 200 x 205 x 200 mm
- Weight: 2 x 18.5 g / m<sup>2</sup>
- Ø roller: 200 mm
- Roll size: 205 x 152 mm



04

**Towel folding paper**

white, for paper dispenser (Item No. 2897-600-2 / -21)

▶ Item no. 2897-600-6

▶ Content: 110 sheet

▶ Quantity per box: 21

▶ Technical specifications

- 2-ply
- 21 pieces of 110 sheets in a box
- Sheet size: 340 x 235 mm
- Packaging dimensions: 85 x 130 x 235 mm
- Weight: 2 x 20.9 g / m<sup>2</sup>





**01**  
**Special „Flex-Pro“ gloves**

► **Technical specifications**

- oil resistant
- nitrile coated
- gray carrier material made of special stretch knit
- with knitted waistband
- very non-slip
- silicone free
- EN 420, EN 388 CAT 2
- Achievement value 4121
- 
- Areas of application:
- Bodywork
- Engine compartment
- Metal processing
- Automotive and commercial vehicle industry
- In parts of the construction industry, medium mechanical loads, a good dry grip and good mechanical resistance are required



Item No.	size	PU	Quantity per box
7798-017-7	7	1	12/144
7798-017-8	8	1	12/144
7798-017-9	9	1	12/144
7798-017-10	10	1	12/144
7798-017-11	11	1	12/144
7798-017-12	12	1	12/144

**02**  
**Special gloves „FLEX PRO“**

► **Technical specifications**

- oil resistant
- nitrile coated
- for fine motor activities
- Nubs in the palm
- excellent fit
- Production according to EN420, EN388 CAT2



Item No.	size	PU	Quantity per box
7798-021-8	8	1	12 / 144
7798-021-9	9	1	12 / 144
7798-021-10	10	1	12 / 144
7798-021-11	11	1	12 / 144

**03**  
**„Mechanics“ protective glove**

► **Technical specifications**

- excellent grip in dry and wet working environments
- special surface profiling through foamed, black latex coating
- very good sense of touch
- very good fit
- Skin-friendly and seamless nylon knit lining
- good mechanical strength
- 
- EN standards / performance values:
- EN 388
- Category II
- Achievement value 3121



Item No.	size	PU	Quantity per box
7798-004-7	7	1	12/144
7798-004-8	8	1	12/144
7798-004-9	9	1	12/144
7798-004-10	10	1	12/144
7798-004-11	11	1	12/144
7798-004-12	12	1	12/144



01

**„Cut“ protective glove**

► Technical specifications

- PU coating on the palm and fingertips
- flexible
- excellent sense of touch
- high abrasion resistance
- good cut protection (level 3) thanks to Dyneema® fiber
- mechanical resilience
- 
- EN standards / performance values:
- EN 388
- Achievement rating 4343

Item No.	size	PU	Quantity per box
7798-005-8	8	1	6/72
7798-005-9	9	1	6/72
7798-005-10	10	1	6/72
7798-005-11	11	1	6/72



02

**„Cut-Pro“ protective glove**

► Technical specifications

- highest cut protection level 5
- special fiber knitted glove
- Color gray
- silicone free
- black nitrile coating on palm and fingertips
- with knitted waistband
- highest wearing comfort
- highest dexterity
- 
- Production according to EN388 CAT2

Item No.	size	PU	Quantity per box
7798-022-8	8	1	72
7798-022-9	9	1	72
7798-022-10	10	1	72
7798-022-11	11	1	72



03

**PU gloves „TOP“**

► Technical specifications

- PU-coated on the palm and fingertips
- Nylon glove
- seamless
- very good wearing comfort
- great flexibility and sense of touch
- non-slip and abrasion resistant
- very good fit
- 
- EN standards / performance values:
- EN 388
- Cat. II
- Achievement score 4131

Item No.	size	PU	Quantity per box
7798-001-7	7	1	12/144
7798-001-8	8	1	12/144
7798-001-9	9	1	12/144
7798-001-10	10	1	12/144
7798-001-11	11	1	12/144



04

**Nitrile protective gloves „BLUE“**

► Technical specifications

- double coating (lower: full nitrile coating, upper: sanded nitrile)
- Partially coated on the palm and fingertips
- highest dexterity
- Knitted cuff
- water repellent
- perfect oil grip
- 
- EN standards 420/388
- Achievement value 4121

Item No.	size	PU	Quantity per box
7798-006-8	8	1	
7798-006-9	9	1	
7798-006-10	10	1	
7798-006-11	11	1	





**01 „NAPS“ interior gloves**

- ▶ Technical specifications
- Nylon / cotton
- circular knitted
- blue PVC knobs on one side
- secure grip
- breathable
- very good fit
- washable
- 
- EN standards / performance values:
- EN 388
- Category 2
- Achievement score 4141



Item No.	size	PU	Quantity per box
7798-003-8	8	1	12/144
7798-003-9	9	1	12/144
7798-003-10	10	1	12/144
7798-003-11	11	1	12/144

**02 Indoor knitted gloves „SKIN“**

- ▶ Technical specifications
- perfect wearing comfort
- very good dexterity
- touchscreen compatible
- with knitted waistband
- blue, black PU coating on palm and fingertips
- Nylon fabric with 18 GAUGE knitting



Item No.	size	PU	Quantity per box
7798-002-8	8	1	12/144
7798-002-9	9	1	12/144
7798-002-10	10	1	12/144
7798-002-11	11	1	12/144

**03 Nitrile protective gloves „YELLOW“**

- ▶ Technical specifications
- lightweight assembly glove with partial nitrile coating
- good dry grip
- Cotton jersey with knitted waistband
- European quality
- 
- Manufacturer information:
- EN standard 388
- Cat. 2
- Achievement value 4121



Item No.	size	PU	Quantity per box
7798-007-8	8	1	12/144
7798-007-9	9	1	12/144
7798-007-10	10	1	12/144
7798-007-11	11	1	12/144



01

**„Electro“ protective glove**

► Technical specifications

- insulating glove made of red natural latex
- Protection against voltage of up to 1000 volts
- CE CATEGORY: III irreversible damage
- conforms to the standards: EN 60903-2003, CEI 903-2002
- Category AZCv
- Length: 41cm
- Thickness: 1mm
- Harmlessness: Corresponds to European standards
- Tactile feeling: class 0



Item No.	size	PU	Quantity per box
7797-020-9	9	1	12
7797-020-10	10	1	12

02

**Butyl protective glove „Chemistry“**

► Technical specifications

- high impermeability to water vapor, gases and toxic chemicals
- high resistance to polar compounds such as esters, ketones, aldehydes, amines, saturated salt solutions as well as acids and alkalis
- EN 374 and EN 388



Item No.	size	PU	Quantity per box
7797-028-10	10	1	10

03

**„Chemistry“ cleaning glove**

► Technical specifications

- Chemical protective gloves
- Nitrile
- Length 32 cm
- velor
- packed in pairs in poly bags
- for food contact



Item No.	size	PU	Quantity per box
7798-009-8	8	1	12/144
7798-009-9	9	1	12/144
7798-009-10	10	1	12/144
7798-009-11	11	1	12/144

04

**PVC protective gloves „CHEMIE“**

► Technical specifications

- universal, light chemical protection and liquid protection, e.g. against numerous alkalis, fats, acids, oils etc.
- 100% liquid-tight
- seamless and double immersed
- secure grip thanks to diamond profile
- antibacterial
- inside cotton fabric
- silicone free
- Length: 32 cm
- 
- EN standards / performance values:
- EN 388 EN 374
- Cat. II / Cat. III
- Performance values: 4121



Item No.	size	PU	Quantity per box
7798-010-10	10	1	6



02

**Nitrile protective gloves „NIBLUE“**

- ▶ Technical specifications
- Colour blue
- BW Jersey
- Roughened inside
- with canvas cuff
- Production according to EN420



Item No.	size	PU	Quantity per box
7798-024-10	10	1	12

01

**Latex protective gloves winter „COLD“**

- ▶ Technical specifications
- moisture-repellent and insulating
- roughened for better grip
- manufactured according to EN 388



Item No.	size	PU	Quantity per box
7798-011-8	8	1	12/144
7798-011-9	9	1	12/144
7798-011-10	10	1	12/144
7798-011-11	11	1	12/144

03

**Nylon glove „ORANGE SOFT GRIP“**

- ▶ Technical specifications
- Terry loop fabric inside
- with double coating
- lower coating: latex fully coated
- top coating: sanded latex
- Partially coated on the palm and fingertips
- Knitted cuff
- extremely soft and cuddly
- perfect flexibility
- highest dexterity
- EN388 / EN511



Item No.	size	PU	Quantity per box
7798-025-8	8	1	12/72
7798-025-9	9	1	12/72
7798-025-10	10	1	12/72
7798-025-11	11	1	12/72



01

**Cryogenic protective gloves „CRYOKIT“**

## ► Technical specifications

- for refueling LNG vehicles and working with liquid nitrogen
- protect against cold contact (down to approx. minus 196 °C) and burns
- waterproof
- Inner insulation: polyester multi-layer fleece (410 g / m<sup>2</sup>) and polyolefin porelle membrane
- with CE certificate, according to EN 511, EN 420, EN 388, Cat.III
- conform to EN511-231 and EN388-2422

Item No.	size	Length cm	PU	Quantity per box
7798-032-9	9	40	1	5
7798-032-10	10	40	1	5
7798-032-11	11	40	1	5
7798-033-9	9	55	1	5
7798-033-10	10	55	1	5
7798-033-11	11	55	1	5



02

**Mechanic gloves „NAPPA“**

## ► Technical specifications

- very supple and durable nappa leather
- breathable textile back
- unlined for the best possible sensitivity
- Velcro on the wrist
- perfect fit and hold thanks to Velcro on the wrist
- only conditionally suitable when wet
- for medium to heavy mechanical loads
- good resistance to abrasion and cuts
- Production according to EN 420, EN 388 CAT 2
- Security values: 2111

Item No.	size	Packing unit	Quantity per box
7798-023-8	8	1	6/72
7798-023-9	9	1	6/72
7798-023-10	10	1	6/72
7798-023-11	11	1	6/72



03

**„ANTI-SHOCK“ gloves**

## ► Technical specifications

- perfect fit
- secure hold
- good wearing and tactile feeling
- highest protection
- ideal for high-vibration and shock-intensive work with hammer drills, compressed air and drilling devices, heavy tools, etc.
- padded, flexible yellow elastane back
- 3 mm shock-absorbing gel inserts reinforced with Clarino® synthetic leather
- Fingertips with extra large anti-slip linings made of silicone
- Ankle protection
- Palm made of breathable Clarino® synthetic leather
- Upper material: synthetic leather and elastane
- Standards: EN 388 CAT II

Item No.	size	PU	Quantity per box
7797-030-9	L	1	72
7797-030-10	XL	1	72
7797-030-11	XXL	1	72



04

**Hand protection tape**

## Flexi tape

## ► Item no. 7695-50-45

## ► Technical specifications

- Dimensions: length 4.50 m, width 50 mm
- self-adhesive protective bandage
- ideal for hand and finger injuries
- water and material resistant
- stretchable and tearable





01  
„COW“ work gloves

- ▶ Technical specifications
- Split leather glove
- Leather thickness: 1.0mm
- Double stitching
- Inner hand lining
- white back and canvas cuff
- 
- EN standards / performance values
- EN 388
- Category 2
- Achievement value 2131



Item No.	size	Packing unit	Quantity per box
7798-014-10	10	1	6/72

02  
„HIDE“ work gloves

- ▶ Technical specifications
- Full cowhide leather glove
- Ankle protection
- rubberized cuff
- Inner hand lining
- tested by TÜV Rheinland
- 
- EN standards / performance values:
- EN 420 EN 388
- Cat. II
- Achievement value 3123



Item No.	size	Packing unit	Quantity per box
7798-013-10	10	1	6/72

03  
„TRUCKER“ artificial leather glove

- ▶ Technical specifications
- with white back and white cuff
- with inner hand lining
- moisture repellent
- manufactured according to EN 388 / Category II
- Achievement value 2111



Item No.	size	PU	Quantity per box
7798-027-10	10	1	12/144



01

**Welding protection glove „FIRE“**

- ▶ Technical specifications
- 5-finger welding glove
- Full / split leather combined
- Split cuff
- Length: 35 cm?
- Certification
- EN 388, EN 12477, TÜV / GS



Item No.	size	PU	Quantity per box
7798-012-10	XXL/10	1	6/72

02

**Welding glove „NEW FIRE“**

- ▶ Technical specifications
- Nappa leather, gray
- Split leather cuff, yellow
- Length 35 cm
- inserted thumb



Item No.	size	PU	Quantity per box
7798-034-10	10	1	6/72



03

**High temperature protective blanket**

- ▶ Item no. 4982-001

- ▶ Technical specifications
- suitable for use in grinding and bodywork
- resistant to sparks and slag
- Dimensions: 160 x 230 cm with fastening straps
- Material: glass filament fabric (flame retardant, non-flammable)
- Weight: 3.5 kg
- Thickness: 0.5mm
- Heat resistance: up to 750 ° C
- Elongation at break: 3%



04

**Welding blanket**

- ▶ Item no. 4982-000

- ▶ Technical specifications
- Dimensions: 229 x 188.5 cm
- Heat resistance: up to 700 ° C
- max.radiation temperature: up to 1,000 ° C
- abrasion and kink resistant





01

**Automatic protection shield**

Carbon look

▶ Item no. 4695-007-100

▶ Technical specifications

- Anti-glare cassette: 1/1/1/2 shade levels  
DIN 4 / 5-8 and 9-13
- TIG suitable from 5 amps grinding mode
- large field of view 53 x 100 mm
- four independent sensors continuously adjustable
- Power supply with solar cell

**Cover plate**

für den Artikel 4695-007-100

▶ Item no. 4695-007-110

▶ PU: 5



02

**Hand protection shield**

90 x 110, without glass

▶ Item no. 4695-006-440

▶ Technical specifications

- Conditionally heat-resistant hand protection shield without an additional lens
- the clear and green front panels are interchangeable

**Cover plate**

▶ Item no. 4695-006-442

▶ Colour: clear

▶ PU: 5

▶ Item no. 4695-006-446

▶ Colour: green

▶ PU: 5



03

**Welding goggles**

foldable

▶ Item no. 4695-006-460

▶ Technical specifications

- These glasses with a foldable front part ensure a safe view when welding

**Replacement glass**

▶ Item no. 4695-006-461

▶ PU: 10

▶ colorless, splinter-free

▶ Item no. 4695-006-465

▶ PU: 10

▶ clear, athermal







01  
**Pro-Vision safety glasses**  
with laminated glass

► Item no. 4695-006-500

- Technical specifications
- Glasses in a sporty design protect the eyes at work thanks to shatterproof laminated glass



02  
**VISION Protect protective goggles**  
with UV protection

► Item no. 7794-005-0

- Technical specifications
- intended for long-term use
  - soft nose pads
  - flexible and soft temples
  - safety goggles
  - Body black / transparent
  - Clear windows
  - Ultraviolet protection filter
  - good color recognition
  - very high wearing comfort
  - UV 400 protection
  - Polycarbonate discs

03 Risk category II

**X-one safety glasses**  
scratch-resistant coating

► Item no. 7794-001-0

- Technical specifications
- scratch-resistant coated
  - very light glasses (28g)
  - sporty design
  - Highest UV protection (100%)
  - universal fit despite simple temples



04  
**Astrospec safety glasses**  
Polycarbonate lens

► Item no. 7794-002-0

► Item no. 7794-002-01 | Spare lenses

- Technical specifications
- Permanently fog-free inside
  - extremely scratch-resistant on the outside
  - Soft component on the temple for increased comfort
  - good adaptability thanks to 4-stage temple length adjustment
  - very easy to change discs
  - 100% UV protection



01

**Nylon safety glasses**  
with laminated glass

▶ Item no. 4695-006-433



02

**Goggles**  
with wide elastic band and clear polycarbonate lens

▶ Item no. 7794-006-0

- ▶ Technical specifications
- with indirect ventilation
- extremely large field of view
- also suitable for people who wear glasses
- anti-fog polycarbonate lens
- high wearing comfort
- adjustable headband
- unrestricted side viewing
- Standards: Category II EN 166 BT N



03

**Panoramic full vision goggles**  
with UV protection

- ▶ Technical specifications
- ergonomically designed goggles
- extremely scratch-resistant on the outside
- Permanently fog-free inside
- Body: gray-transparent
- Headband: Uvex, 25 mm
- highest UV protection (100%)
- unrestricted side viewing



Item No.	execution	PU
7794-003-0	Full view glasses Panorama	1
7794-003-01	Spare lenses	1

04

**Protective shield**  
2 parts

- ▶ Technical specifications
- Head mount made of polypropylene
- extremely high impact resistance and chemical resistance



Item No.	execution	PU
7907-002-000	Head harness	1
7936-000-000	Glass	1

05

**Normfest knee pad**  
475x235x26mm

▶ Item no. 7716-060-5

- ▶ Technical specifications
- excellent as a pad for the knees
- for work such as changing microfilters in vehicle interiors (glove compartments)
- extremely light
- fits in any drawer





01

**Donor**  
for earplugs

▶ Item no. 7695-006-500

## ▶ Technical specifications

- Incl. Mounting material
- without content
- matching articles 7695-006-501 and 7695-006-502

02

**Ear plugs**  
300 pairs

▶ Item no. 7695-006-501

## ▶ Technical specifications

- made of soft PU
- loose in a large polybag
- conical shape
- high wearing comfort
- permanent recovery
- excellent insulation values
- EN 352-2
- SNR 34 db (A)
- H 33 db (A)



03

**Ear plugs**  
50 pairs

▶ Item no. 7695-006-502

## ▶ Technical specifications

- made of soft PU
- conical shape
- high wearing comfort
- permanent recovery
- excellent insulation values
- EN 352-2
- SNR 34 db (A)
- H 33 db (A)
- M 31 db (A)
- L 28 db (A)

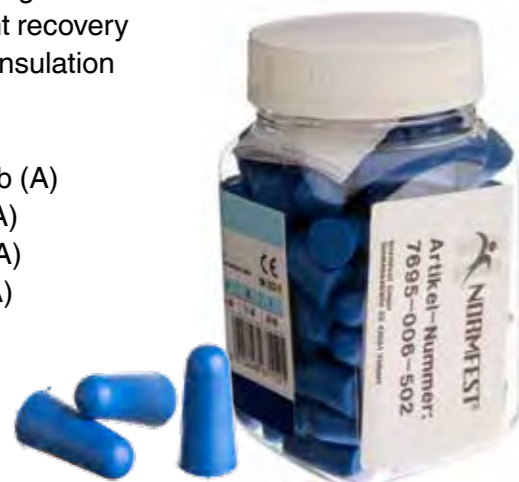

04

**Ear plugs**  
100 pairs

▶ Item no. 7695-006-600

## ▶ Technical specifications

- without tape
- hygienically packed in pairs

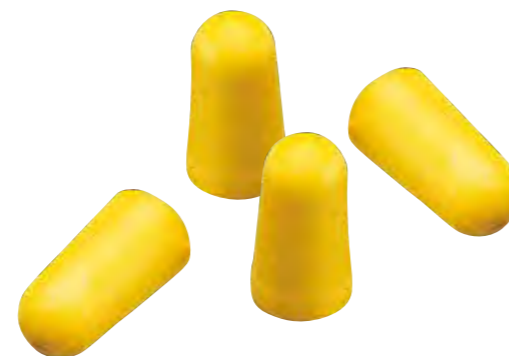

05

**Capsule hearing protection**

▶ Item no. 7695-006-510

## ▶ Technical specifications

- uvex K2 foldable
- Foldable earmuffs
- with easy-to-adjust length adjustment for a perfect carrying position
- padded headband
- soft surface of the capsule cushions
- optimal wearing comfort even for long-term use
- When designing the capsule, attention was paid to lightness and small capsule volume
- SNR 31 dB H = 35 dB, M = 29 dB, L = 21 dB
- Color black / hi-viz
- Weight 230 g



06

**ear protection**

▶ Item no. 7126-003-000

## ▶ Technical specifications

- very light and comfortable
- Headband made of special plastic
- very soft ear pads
- pleasant contact pressure
- SNR value 25 dB



07

**Ear defenders**

▶ Item no. 7695-006-610

▶ Item no. 7695-006-611 | Spare plugs

## ▶ Technical specifications

- the handy ear defenders are ideal for quick use in most noise situations
- the oval pads ensure better fixation in the ear canal

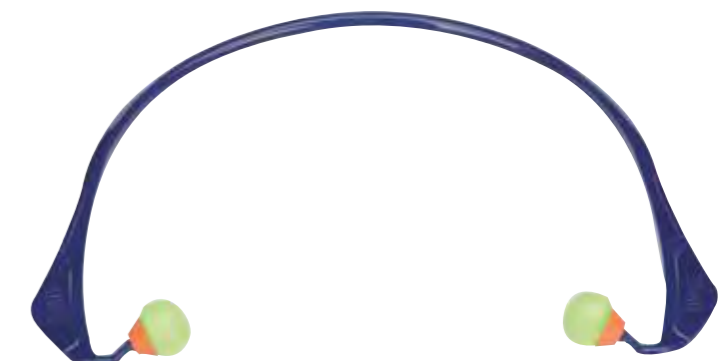



01  
**Floor module**  
with plinth without universal shelf

- ▶ Item no. 7101-001-006
- ▶ Technical specifications
  - Load capacity per shelf 20 kg
  - Dimensions: H 544 x W 580 x D 340 mm
  - RAL 7035 light gray
  - Similar to illustration



02  
**Floor module**  
with plinth and a universal shelf 369 mm high

- ▶ Item no. 7101-001-007
- ▶ Technical specifications
  - Load capacity per shelf 20 kg
  - Dimensions: H 544 x W 580 x D 340 mm
  - RAL 7035 light gray
  - Similar to illustration



03  
**Floor module**  
with plinth and a universal shelf 450 mm high

- ▶ Item no. 7101-001-008
- ▶ Technical specifications
  - Load capacity per shelf 20 kg
  - Dimensions: H 544 x W 580 x D 340 mm
  - RAL 7035 light gray
  - Similar to illustration



04  
**Floor module**  
Universal module triple inclined

- ▶ Item no. 7101-001-005
- ▶ Technical specifications
  - Load capacity per shelf 20 kg
  - Dimensions: H 544 x W 580 x D 340 mm
  - RAL 7035 light gray





01

**Floor module**

Chute module

▶ Item no. 7101-001-004

▶ Technical specifications

- Universal tubs including 10 variable partition plates
- Compartment width 87 mm
- Dimensions: H 444 x W 580 x D 340 mm
- RAL 7035 light gray



02

**Bottom corner module**

Corner module with plinth and a universal shelf

▶ Item no. 7101-004-002

▶ Technical specifications

- Supporting force per shelf 20 kg
- Dimensions: H 444 x W 623 x D 623 mm
- RAL 7035 Light grey



03

**Universal floor 1-fold**

Middle section module

▶ Item no. 7101-002-007

▶ Technical specifications

- Supporting force per shelf 20 kg
- Dimensions: H 444 x W 580 x D 340 mm
- RAL 7035 light grey



04

**Universal shelves 2-fold**

Middle section module

▶ Item no. 7101-002-000

▶ Technical specifications

- Supporting force per shelf 20 kg
- Dimensions: H 444 x W 580 x D 340 mm
- RAL 7035 light grey



05

**Universal module triple inclined**

Middle module

▶ Item no. 7101-002-012

▶ Technical specifications

- Load capacity per shelf 20 kg
- Dimensions: H 544 x W 580 x D 340 mm
- RAL 7035 light grey



06

**Middle section module**

Drawer module lockable 3 times

▶ Item no. 7101-002-005

▶ Description

- Supporting force per drawer 8 kg
- Dimensions: H 444 x W 580 x D 340 mm
- RAL 7035 light grey



01

**Middle section module**

6-point lockable drawer module

▶ Item no. 7101-002-010

▶ Technical specifications

- Load capacity per drawer 8 kg
- Dimensions: H 444 x W 580 x D 340 mm
- RAL 7035 light gray
- Similar to illustration



02

**Foam inlay**

for drawers

▶ Item no. 7101-010



03

**Chute with 10 dividing plates**

Middle section module

▶ Item no. 7101-002-009

▶ Technical specifications

- Universal tubs including 10 variable partition plates
- Compartment width 87 mm
- Dimensions: H 444 x W 580 x D 340 mm
- RAL 7035 light gray



04

**Middle section module**

Socket module, 1-way

▶ Item no. 7101-002-001

▶ Description

- with can compartment shelf, 6 compartments
- Dimensions: H 444 x W 580 x D 340 mm
- RAL 7035 light gray



05

**Middle section module**

Bottom with perforated plate

▶ Item no. 7101-002-003

▶ Technical specifications

- Load capacity per shelf 20 kg
- Dimensions: H 444 x W 580 x D 340 mm
- RAL 7035 light gray

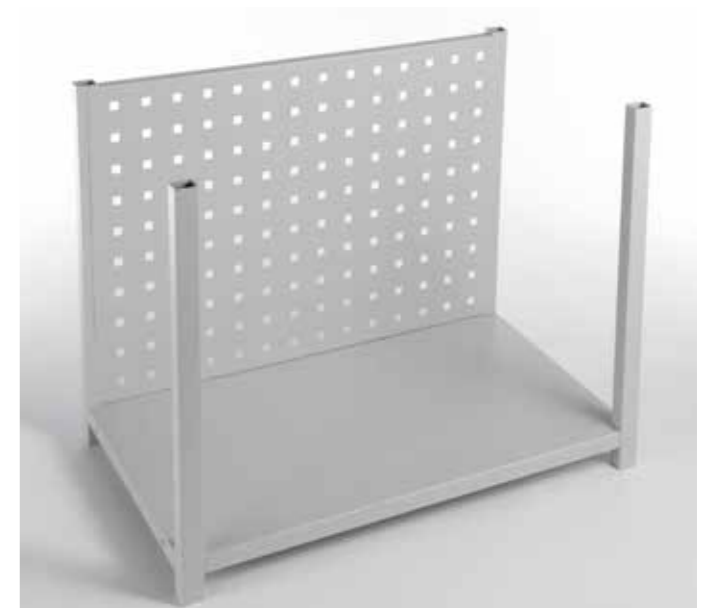

06

**Middle section module**

Universal corner module

▶ Item no. 7101-004-001

▶ Technical specifications

- Supporting force per shelf 20 kg
- Dimensions: H 444 x W 623 x D 623 mm
- RAL 7035 Light gray





01

**Final module**

with universal shelf

▶ Item no. 7101-003-000

▶ Technical specifications

- Supporting force per shelf 20 kg
- Dimensions: H 444 x W 580 x D 340 mm
- RAL 7035 light grey



04

**Final module**

Chute module inclined

▶ Item no. 7101-003-004

▶ Technical specifications

- Supporting force per shelf 20 kg
- Dimensions: H 444 x W 580 x D 340 mm
- RAL 7035 light grey



02

**Final module**

Universal module 2-way inclined

▶ Item no. 7101-003-005



05

**Final module**

with universal shelf

▶ Item no. 7101-004-000

▶ Technical specifications

- Supporting force per shelf 20 kg
- Dimensions: H 444 x W 580 x D 340 mm
- RAL 7035 Light grey



03

**with can shelf, 6-fold**

Final module

▶ Item no. 7101-003-001

▶ Technical specifications

- Supporting force per shelf 20 kg
- Dimensions: H 444 x W 580 x D 340 mm
- RAL 7035 light grey



06

**Final module**

with perforated plate

▶ Item no. 7101-003-002

▶ Technical specifications

- Dimensions: H 444 x W 580 mm x D 340 mm
- Colour RAL 7035 light grey



01

**Middle cabinet module**

Lamp cabinet module lockable

▶ Item no. 7101-002-008

## ▶ Technical specifications

- Storage of 56 car lamps in the foam insert
- two shelves adjustable in height in a 68mm grid
- lockable plexiglass door
- stable and high quality steel construction
- modular structure with almost unlimited expansion options
- quick and easy assembly
- individual plannability
- optimal overview and inventory control
- quick and easy access to your goods
- Clear and space-saving storage of car lamps, DIN and standard parts, spray cans, cartridges, fastening material, workshop supplies and many other items



02

**Floor cabinet module**

lockable cabinet

▶ Item no. 7101-001-002

## ▶ Technical specifications

- three shelves height adjustable in a grid of 68 mm
- lockable metal door
- stable and high quality steel construction
- modular structure with almost unlimited expansion options
- quick and easy assembly
- individual plannability
- optimal overview and inventory control
- quick and easy access to your goods
- Clear and space-saving storage of car lamps, DIN and standard parts, spray cans, cartridges, fastening material, workshop supplies and many other items



03

**Perforated plate**

including fastening

▶ Item no. 7101-005-002

## ▶ Technical specifications

- Dimensions: H 896 x 336 mm
- Color RAL 7035 light gray

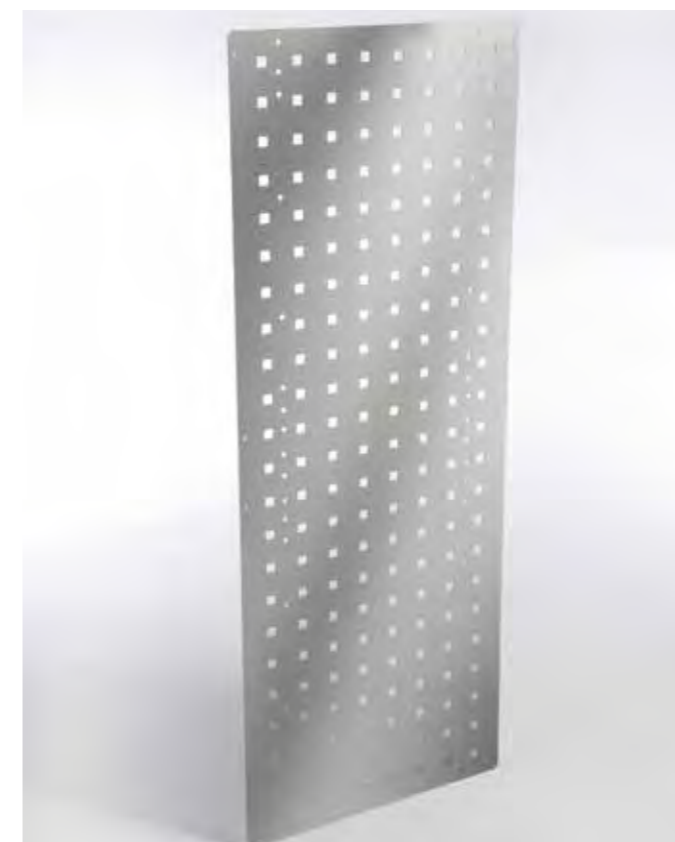

05

**Final module**

Advertising sign

▶ Item no. 7101-005-000



04

**Shelf connector**

including mounting kit

▶ Item no. 7101-005-003



06

**Wall anchoring set**

▶ Item no. 7101-005-004





**01**  
**Perforated plates**  
unequipped

- ▶ **Technical specifications**
- RAL 7035 light gray
- impact and scratch resistant plastic coating
- specially shaped beams
- Sheet steel 1.25mm
- concealed screw holes



Item No.	Length [mm]	Height mm
7100-000-1	500	450
7100-000-2	1000	450

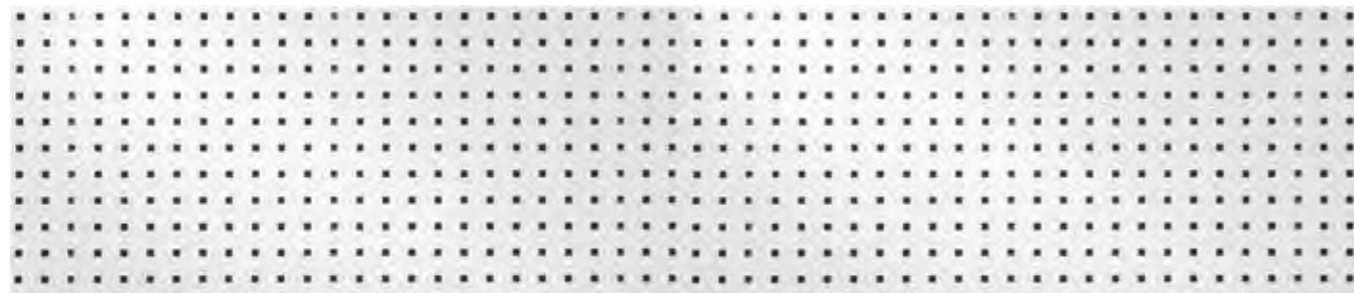

**02**  
**Slotted plates**  
unequipped

- ▶ **Technical specifications**
- suitable for storage boxes of size 3 (H / L / W 130/230 / 140mm) and size 4 (H / L / W 75/160 / 95mm)
- RAL 7035 light gray
- impact and scratch resistant plastic coating
- specially shaped beams
- Sheet steel 1.25mm
- concealed screw holes

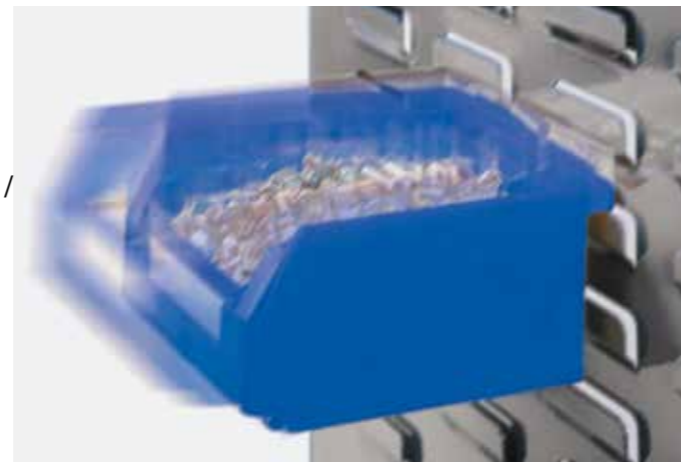

Item No.	Width (mm)	Height mm	execution	for storage boxes	
				Size 3	Size 4
7100-001-1	500	450	Wide format	9 x	16 x
7100-001-3	1000	450	Wide format	18 x	36 x
7100-001-2	450	1000	Wide format	12 x	32 x



**03**  
**Tool clamp**  
small



Item No.	Size
7100-000-305	19 mm

**04**  
**Tool holder**  
straight mandrel

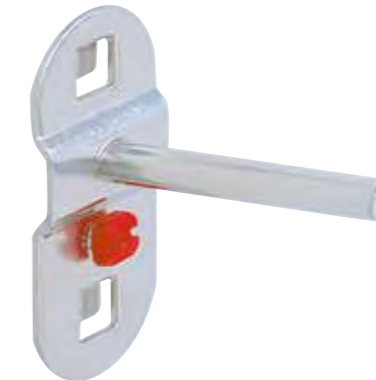

Item No.	Size
7100-000-304	150 mm

**05**  
**Tool holder**  
angled mandrel



Item No.	Size
7100-000-301	50 mm
7100-000-302	100 mm
7100-000-3	150 mm
7100-000-303	200 mm

**06**  
**Holder strip for cans and bottles**  
unequipped

▶ Item no. 7100-002-01

- ▶ **Technical specifications**
- Dimensions (HxWxD): 50 mm x 500 mm x 80 mm
- 2 oval holes 22/31 x 57 mm
- 3 round holes 51 mm
- 2 oval holes 20/27 x 46 mm
- 1 round hole 31 mm



**07**  
**Round can holder**  
3-way

▶ Item no. 7100-000-6

- ▶ **Technical specifications**
- Width: 300mm
- Ø 70mm
- Color: aluminum

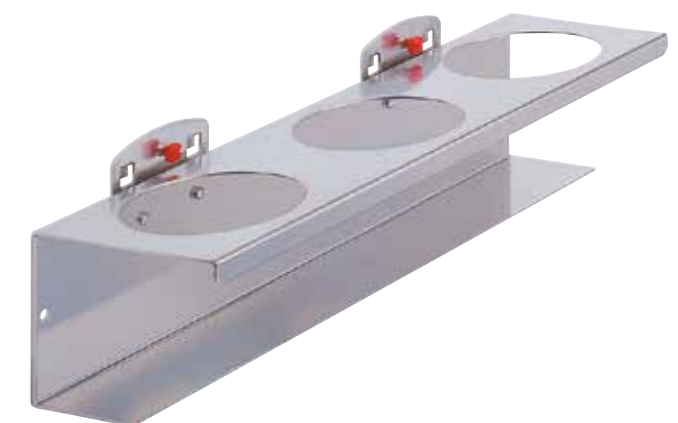

01  
**Cable reel holder**

► Item no. 7100-002-02

► Technical specifications

- Spool holder up to an axis dimension of 17 mm
- Color: aluminum
- Width: max. 78 / Ø 170 mm



02  
**Holder for fuel hose / heat shrink hose**

► Item no. 7100-002-03

► Technical specifications

- Dimensions: (WxD): 490 mm x 243 mm
- Color: light gray

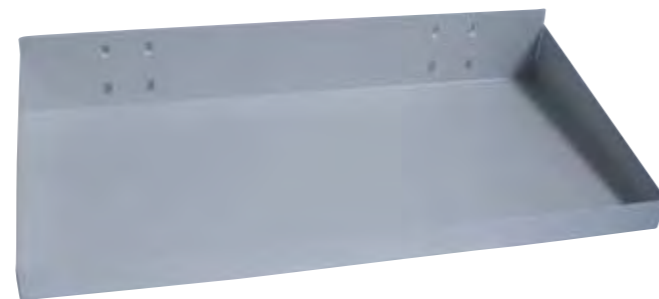

03  
**Wall holder**  
für Einweghandschuh-Boxen

► Item no. 7101-016

► Technical specifications

- for three glove boxes
- only suitable for the Normfest disposable glove boxes
- „NITRIL“ (Art.-No. 7798-016) and „LATEX“ (Art.-No. 7798-015)



04  
**Emery cloth dispenser**  
unequipped

► Item no. 7100-002-07

► Technical specifications

- Dispenser for up to three emery cloth rolls, for attachment to perforated panels.



05  
**Velcro tape**  
self-adhesive

Item No.	Width (mm)	Length [m]	PU
3985-80	20	10	1/10



06  
**SELF-ADHESIVE LABELING STRIPS**  
self-adhesive

Item No.	Width (mm)	Length [mm]
7100-000-5	29	430
7100-000-7	29	940



07  
**Magnetic tape**  
Length: 10.0 m, thickness: 0.65 mm

Item No.	Width (mm)	Length [m]	PU
1961-004-201	20	10	1
1961-004-251	25	10	1



08  
**PVC, 30 x 80 mm**  
Magnet label

► Item no. 1961-004-021

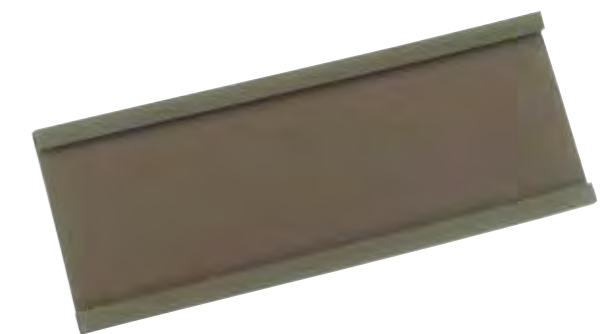



01  
**Storage boxes**  
Length: 500/450 mm

Width: 300mm

Height: 180 mm

Item No.	colour
1962-1-1	blue
1962-2-1	grey



02  
**Storage boxes**  
Length: 350/300 mm

Width: 200mm

Height: 150mm

Item No.	colour
1962-1-2	blue
1962-2-2	grey



03  
**Storage boxes**  
Length: 230/200 mm

Width: 140mm

Height: 130 mm

Item No.	colour
1962-1-3	blue
1962-2-3	grey



04  
**Storage boxes**  
Length: 160/140 mm

Width: 95 mm

Height: 75mm

Item No.	colour
1962-1-4	blue
1962-2-4	grey



05  
**Storage boxes**  
Width: 188 mm

Height: 80 mm

Item No.	execution	Length [mm]	PU
1961-945-31	5-fold	300	1
1961-945-30	7-fold	400	1
1961-945-36	9-fold	500	1
1961-945-34	Partition wall		10

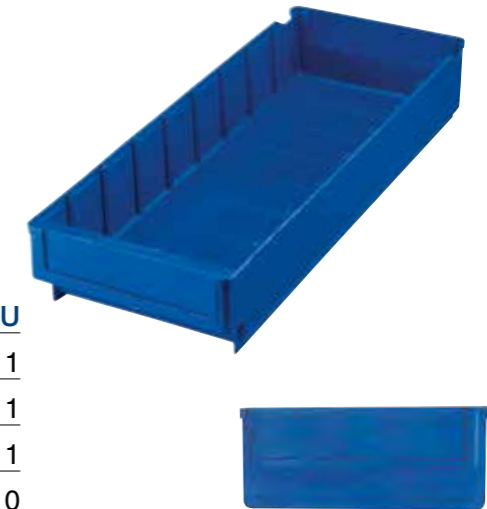

06  
**Storage boxes**  
Width: 94 mm, height: 80 mm

Item No.	execution	Length [mm]	PU
1961-945-33	5-fold	300	1
1961-945-32	7-fold	400	1
1961-945-37	9-fold	500	1
1961-945-35	Partition wall		10
1961-945-29	Labels with protective film		100



07  
**Parts box**  
Width: 90 mm, height: 50 mm, length: 270 mm

Item No.	execution	Length [mm]	PU
1961-0	Parts box	270	1
1961-01	Partition wall		10
1961-02	Labels		100

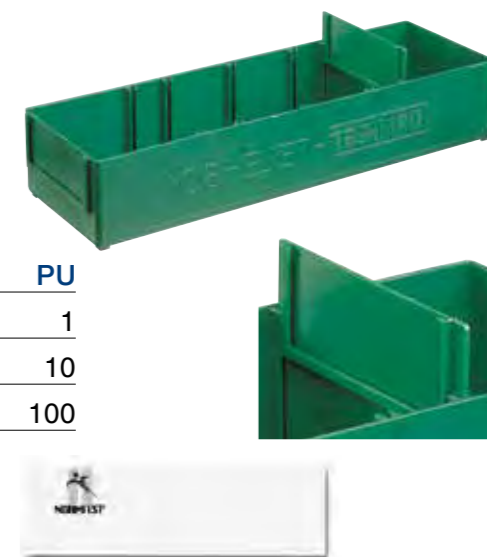



Compressed air





01

**1/2 „mini impact wrench**

▶ Item no. 8696-510-001

## ▶ Technical specifications

- Loosening torque max .: 1000 Nm
- compact design for tight spaces
- Right / left rotation // one-hand switching
- incl. plug nipple with 1/4 „male thread
- Exhaust air is guided down through the handle
- Cold-insulated handle
- High-performance jumbo hammer mechanism
- Ergonomically shaped handle and housing for improved handling and operation
- Output: square 12.5 mm
- Net weight: 1450 g
- Tightening torque max .: 610 Nm
- Recommended torque: 474 Nm
- Air requirement: 141.5 l / min
- Coupling plug: nominal width 7.2 (included)
- Air connection inlet: internal thread (IG) 12.91 mm (1/4)
- Revolutions / minute: 8500 rpm
- Forward / reverse: multi-stage
- Operating pressure: 6.3 bar
- Sound pressure level: 94.6 dB (A) Lp A
- Sound power level: 105.6 db (A) Lp W
- Hose diameter: 10 mm
- Vibration acceleration: 5.99 m / s<sup>2</sup>
- Screw size: 16 M.



02

**1/2 „impact wrench**

▶ Item no. 8696-510-002

## ▶ Technical specifications

- Loosening torque max: 1200 Nm
- Infinitely variable speed
- three different tightening power levels
- incl. plug nipple with 1/4 „male thread
- High-performance double hammer mechanism
- cold-insulating handle?
- Output: square 12.5 mm
- Net weight: 2.1 kg
- Tightening torque max: 610 Nm
- Recommended torque: 550 Nm
- Air requirement: 183.9 l / min
- Coupling plug: nominal width 7.2
- Air connection inlet: 12.91 mm (1/4)
- Revolutions / minute max: 7500 rpm
- Forward / reverse: multi-stage
- Operating pressure: 6.3 bar
- Sound pressure level: 107.4 dB (A) Lp A
- Sound power level: 107.4 db (A) Lp W
- Hose diameter: 10 mm
- Vibration acceleration: 7.76 m / s<sup>2</sup>
- Screw size: 16 M.



01

**1/2 „premium impact wrench**

▶ Item no. 8696-510-003

▶ Technical specifications

- Power regulator with 3 setting levels
- R / L switch lever for one-hand operation
- Powerful double hammer
- Ergonomic handle
- For right and left handers
- Ideal for tire removal and assembly
- Low vibration
- Small version for better access even in tight spaces
- Composite housing?
- Loosening torque max: 1486 Nm
- Drive: 1/2 „
- Idle speed: 8500 rpm
- Vibrations: 12.92 m / s<sup>2</sup>
- Air consumption: 113 l / min
- Max. Pressure: 6 bar
- Sound power level: 96 dB
- Length: 171 mm
- Weight: 1950g
- incl. plug nipple with 1/4 „male thread



02

**1/2“ Mini Double Impact Hammer**

▶ Item no. 8696-510-004

▶ Technical specifications

- Loosening torque maximum: 1400 Nm
- Tightening torque maximum: 745 Nm
- Recommended torque: 620 Nm
- Extra short - only 100 mm
- High-performance double-hammer percussion mechanism
- Powerful application in confined spaces
- Suspension bracket
- One-handed operation - can be used by right- and left-handers alike
- Exhaust air ducted downwards through the handle
- Low vibration
- Simple operation
- Air connection inlet: internal thread 16.41 mm (3/8“)
- Coupling plug: nominal width 7.2 (included)
- Hose diameter (recommended): 10 mm
- Operating pressure (bar): 6.3
- Sound power level (at operating pressure): 102 db(A) Lp W
- Vibration acceleration: 8.74 m/s<sup>2</sup>
- Loosening torque (max) determined with screw size M: 16
- Right/left rotation: three-stage (right and left rotation)
- Cold-insulating handle
- Output: Square drive solid 12.5 mm (1/2 inch)
- Dimensions / length: 100 mm x 67 mm x 167 mm
- Net weight (kg): 1.32 kg
- Maximum loosening torque: 1400 Nm
- Sound pressure level (at operating pressure): 92.7 dB
- Revolutions/minute: 9000
- Air requirement [l/min]: 135 l/min (2.2 l/sec)





01

**3/4 „mini impact wrench**

▶ Item no. 8696-510-005

## ▶ Technical specifications

- Cold-insulating handle
- High-performance double hammer mechanism
- three-stage (clockwise), single-stage (counterclockwise)
- Loosening torque max: 1890 Nm
- Downforce: 3/4
- Tightening torque max: 1085 Nm
- Operating pressure: 6.3 bar
- Recommended torque: 922 Nm
- Coupling plug: nominal width 7.2
- Air connection inlet: internal thread 16.41 mm
- Air requirement: 153 l / min
- Net weight: 2.1 kg
- Sound pressure level: 104 dB (A) Lp A
- Sound power level: 93 db (A) Lp W
- Hose diameter: 10 mm
- Screw size: 32 M.
- Revolutions / minute: 7300
- Vibration acceleration: 7.47 m / s<sup>2</sup>
- incl. plug nipple with 1/4 „male thread



02

**1 „impact wrench, long version**

▶ Item no. 8696-510-006

## ▶ Technical specifications

- compact lightweight
- high torque
- built-in force regulator
- 15 cm extended anvil
- Striking mechanism: double hammer
- Weight: 7 kg
- Drive: 1 „
- Idle speed: 5500 rpm
- Vibration: 11.4 m / s<sup>2</sup>
- Air consumption: 340 l / min
- Max. Pressure: 6.2 bar
- Sound power level: 124.6 dB
- Length: 528 mm
- incl. plug nipple with 1/4 „male thread
- 
- 3-step tightening and loosening torque
- Tightening torque 5 sec
- 60% - 1.545 Nm
- 80% - 2.189 Nm
- 100% - 2.576 Nm
- 
- Loosening torque 5sec
- 60% - 1.789 Nm
- 80% - 2.535 Nm
- 100% - 2.983 Nm



01

**1/4 „mini ratchet screwdriver**

▶ Item no. 8696-520-001

## ▶ Technical specifications

- extremely small design
- max.torque: 32 Nm
- m Right / left rotation
- incl. plug nipple with 1/4 „male thread
- Weight: 457 g
- Drive: 1/4 „
- Idle speed: 240 rpm
- Vibration: 10.5 m / s<sup>2</sup>
- Air consumption: 85 l / min
- Sound power level: 92 dB
- Length: 120 mm



02

**3/8 „ratchet screwdriver**

▶ Item no. 8696-520-002

## ▶ Technical specifications

- Weight: 465 g
- Drive: 3/8 „
- Idle speed: 240 rpm
- Max. Torque: 32 Nm
- Vibration: 10.5 m / s<sup>2</sup>
- Air consumption: 85 l / min
- Sound power level: 92 dB
- Length: 120 mm
- incl. plug nipple with 1/4 „male thread



03

**1/4 „ratchet screwdriver**

▶ Item no. 8696-520-004

## ▶ Technical specifications

- Weight: 606 g
- Drive: 1/4 „
- Idle speed: 240 rpm
- Max. Torque: 41 Nm
- Vibration: 1.61 m / s<sup>2</sup>
- Air consumption: 70 l / min
- Sound power level: 97 dB
- Length: 175 mm
- incl. plug nipple with 1/4 „male thread



04

**3/8 „mini ratchet screwdriver**

▶ Item no. 8696-520-003

## ▶ Technical specifications

- Weight: 762 g
- Drive: 3/8 „
- Idle speed: 240 rpm
- Max. Torque: 41 Nm
- Vibration: 1.61 m / s<sup>2</sup>
- Air consumption: 70 l / min
- Sound power level: 97 dB
- Length: 175 mm
- incl. plug nipple with 1/4 „male thread





01

**3/8 „ratchet screwdriver**

▶ Item no. 8696-520-006

## ▶ Technical specifications

- Drive: 3/8 „
- max.torque: 70 Nm
- Adjustable speed
- incl. plug nipple with 1/4 „male thread
- stable, reversible air ratchet
- the polyurethane handle maintains an even temperature and insulates against vibrations
- ideal for dismantling and assembling screws and nuts in the automotive sector
- Composite housing
- Weight: 1,348 g
- Idle speed: 175 rpm
- Vibration: 0.4 m / s<sup>2</sup>
- Air consumption: 85 l / min
- Sound power level: 85 dB
- Length: 264 mm



02

**1/2 „ratchet screwdriver**

▶ Item no. 8696-520-005

## ▶ Technical specifications

- stable, reversible compressed air ratchets with variable speed
- the trigger offers better speed control
- the polyurethane handle maintains an even temperature and insulates against vibrations
- ideal for dismantling and assembling screws and nuts in the automotive sector
- Composite housing
- 
- Weight: 1,363 g
- Drive: 1/2 „
- Idle speed: 175 rpm
- Max. Torque: 70 Nm
- Vibration: 0.4 m / s<sup>2</sup>
- Air consumption: 85 l / min
- Sound power level: 85 dB
- Length: 264 mm
- incl. plug nipple with 1/4 „male thread



03

**Die grinder angled**

▶ Item no. 8696-530-001

## ▶ Technical specifications

- Weight: 711 g
- Max. Speed: 20000 rpm
- Vibration: 0.5 m / s<sup>2</sup>
- Air consumption: 59 l / min
- Sound power level: 82 dB
- Length: 155 mm
- Recording: 6 mm
- incl. plug nipple with 1/4 „male thread



04

**Die grinder straight**

▶ Item no. 8696-530-002

## ▶ Technical specifications

- Ergonomically soft handle insulates against vibrations and thus reduces user fatigue
- Power / speed controller enables simple speed control
- Rear outlet facing away from the user and work areas
- Double bearing shaft means precise shaft concentration and a minimum of vibrations
- Composite housing
- Weight: 600 g
- Max. Speed: 25,000 rpm
- Vibration: 0.4 m / s<sup>2</sup>
- Air consumption: 85 l / min
- Sound power level: 85 dB
- Length: 155 mm
- Recording: 6 mm
- incl. plug nipple with 1/4 „male thread



05

**Assembly key for die grinder**

Item No.	size
8696-530-014	14 mm
8696-530-019	19 mm



01

**Eccentric sander**

▶ Item no. 8696-530-003

## ▶ Technical specifications

- Max. Speed: 10,000 rpm
- Sanding stroke: 2.5 mm
- Hole diameter: 5 mm
- Weight: 900g
- Vibrations: 2.5 m / s<sup>2</sup>
- Air consumption: 45 l / min
- Sound power level: 80 dB
- Length: 248 mm
- incl. plug nipple with 1/4 „male thread



02

**Depth grinder / cut-off saw**

▶ Item no. 8696-530-005

## ▶ Technical specifications

- Idle speed: 15,000 rpm
- Power: 0.85 HP / 0.63 kW
- Total length: 375 mm
- Construction height: 45 mm
- Weight: 1.1 kg
- Air pressure: 6.3 bar
- Compressed air connection: 1/4 „
- Cutting disc: 100 x 1.0 x 10 mm
- adjustable bracket on the back
- incl. plug nipple with 1/4 „male thread
- incl. 1 cutting disc
- including maintenance oil



03

**Belt sander**

▶ Item no. 8696-530-004

## ▶ Technical specifications

- Width of the sanding belt: 10 mm
- Weight: 949 g
- Max. Speed: 18,000 rpm
- Vibration: 0.4 m / s<sup>2</sup>
- Air consumption: 57 l / min
- Sound power level: 85 dB
- Length: 330 mm
- incl. plug nipple with 1/4 „male thread



04

**Belt sanding belts**

## ▶ Technical specifications

- for belt sander (Item No. 8696-530-004)
- Dimensions: 10 mm x 330 mm

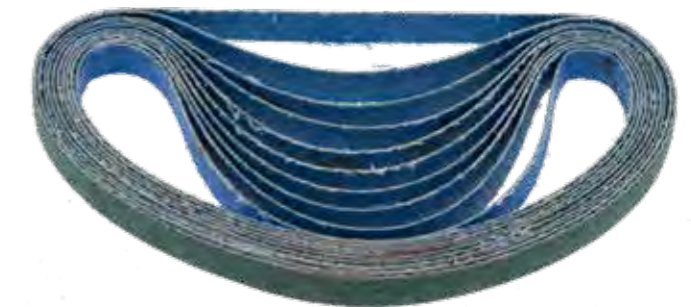

Item No.	Grit	Packing unit
8696-530-040	40	10
8696-530-060	60	10
8696-530-080	80	10
8696-530-120	120	10



01

**Mini grinder**

▶ Item no. 8696-530-006

▶ Technical specifications

- Small version
- For polishing wheel sizes 2 „or 3“ (50 or 75 mm)
- Max. Speed: 17,000 rpm
- Air consumption: 57 l / min
- Length: 109 mm
- Weight: 677 g
- Idle speed: 15000 rpm
- Vibrations: <math><2.5 \text{ m / s}^2</math>
- Sound power level: 89.4 dB
- incl. plug nipple with 1/4 „male thread



02

**Replacement plate for mini grinder**

Item No.                      Ø mm

8696-530-075                      75

8696-530-050                      50



03

**Jigsaw**

▶ Item no. 8696-540-001

▶ Technical specifications

- Beats Per Minute: 9,000 BPM
- Stroke length: 10mm
- Vibration: 8.5 m / s<sup>2</sup>
- Weight: 610 g
- Volume: 86dBA
- Air consumption: 99 l / min
- incl. plug nipple with 1/4 „male thread



04

**Saw blade for jigsaw**

▶ Technical specifications

- Explanation tpi (teeth per inch): teeth per inch (1 inch = 25.4 mm)
- Length: 100mm
- Made in Germany

Item No.                      execution                      Packing unit

8696-540-018                      18 tpi                      5

8696-540-024                      24 tpi                      5

8696-540-032                      32 tpi                      5



01

**drilling machine**

▶ Item no. 8696-540-002

▶ Technical specifications

- Ergonomic comfort handle ensures a comfortable temperature during operation and insulates against vibrations
- Composite housing
- Drill chuck: 10 mm
- Weight: 900 g
- Max speed: 1,800 rpm
- Vibration: 0.4 m / s<sup>2</sup>
- Air consumption: 100 l / min
- Sound power level: 90 dB
- Length: 195 mm
- incl. plug nipple with 1/4 „male thread



02

**Angle drill**

▶ Item no. 8696-540-008

▶ Technical specifications

- Weight: 900 g
- Length: 220 mm
- Max. Speed: 1800 rpm
- Vibration: 0.6 m / s<sup>2</sup>
- Air consumption: 99 l / min
- Sound power level: 83 dB
- Keyless chuck: 10 mm
- incl. plug nipple with 1/4 „male thread



03

**Mini polishing machine**

▶ Item no. 8696-540-004

▶ Technical specifications

- Weight: 600 g
- Max. Speed: 5,500 rpm
- Adjustable speed: yes
- Vibrations: <2.5 m / s<sup>2</sup>
- Air consumption: 84 l / min
- Sound power level: 89.4 dB
- Length: 130 mm
- Velcro plate diameter: approx. 75mm
- incl. plug nipple with 1/4 „male thread



04

**Velcro plate**

Replacement plate for mini polishing machine

Item No.                      Ø mm

8696-540-050                      50

8696-540-075                      75





01

**Tin nibbler**

▶ Item no. 8696-540-006

## ▶ Technical specifications

- regular size and design
- Pull cut for metal thickness 1.5 mm with a cutting capacity of 0.9 m / min
- Double-tooth planetary gear set offers more transmission power for smoother operation
- Polyurethane attack maintains the temperature and insulates against vibrations
- easy operation and regulation
- Composite housing
- Weight: 988 g
- Length: 178 mm
- Max. Speed: 2600 rpm
- Vibration: 0.8 m / s<sup>2</sup>
- Air consumption: 107 l / min
- Sound power level: 90 dB
- Cutting thickness: aluminum 1.6 mm / steel 1.2 mm
- incl. plug nipple with 1/4 „male thread



02

**Blind rivet gun**

▶ Item no. 8696-540-003

## ▶ Technical specifications

- Pneumatic / hydraulic for pop riveting
- 4 mouthpieces (one pre-assembled)
- with robust metal housing
- Coupling plug with swivel joint for flexible use
- Possible rivet sizes: 2.4 - 3.2 - 4.0 - 4.8mm
- Aluminum rivets: 2.4 - 4.8 mm
- Steel rivets: 2.4 - 4.8 mm
- Stainless steel rivets: 2.4 - 3.2 mm
- High tensile force: 11945 N
- Stroke length: 14 mm
- Air connection inlet: internal thread 1/4 "
- Operating pressure (bar): 6.2
- Weight: 1,500 g
- incl. plug nipple with 1/4 „male thread



03

**Tin snips**

▶ Item no. 8696-540-007

## ▶ Technical specifications

- light and durable pistol grip for best handling
- Heavy-duty cutting blades make a clean cut in cold-rolled steel
- Polyurethane attack maintains the temperature and insulates against vibrations
- ideal for trimming, cutting and separating various metal sheets
- 
- : 1.205 kg
- Length: 240 mm
- Max. Speed: 2,600 rpm
- Vibration: 0.7 m / s<sup>2</sup>
- Air consumption: 107 l / min
- Sound power level: 86 dB
- Cutting thickness: aluminum 1.6 mm / steel 1.2 mm
- incl. plug nipple with 1/4 „male thread



04

**Spacer**

▶ Item no. 8696-540-027



05

**Scissors blade for tin snips**

## ▶ Technical specifications

- for tin snips (Item No. 8696-540-007)

Item No.	Model
8696-540-017	Spare disc for mini grinder
8696-540-019	Spare needles for needle scalers
8696-540-020	medium



01

**Chisel hammer set**

▶ Item no. 8696-540-009

## ▶ Technical specifications

- incl. 5 chisels and penholder
- Weight: 2,450 g
- Beats per minute: 4300 bpm
- Air consumption: 269 l / min
- Vibration: 15 m / s<sup>2</sup>
- incl. plug nipple with 1/4 „male thread



03

**Tyre inflation gauge**

▶ Item no. 8696-540-010

## ▶ Technical specifications

- Max. Pressure: 8 bar
- Pressure gauge measuring range: 0 - 12 bar
- Division: 0.1 bar
- Flexible hose, length: 400 mm
- Pressure gauge diameter: 63 mm
- Air connection inlet: internal thread 12.91 mm (1/4 ")
- Coupling plug: nominal width 7.2 (included)
- Operating pressure (bar): 6.3
- Net weight: 0.41 kg
- incl. plug nipple with 1/4 „male thread



02

**Chisel set**

▶ Item no. 8696-540-029

## ▶ Technical specifications

- from the case 8696-540-009





01

**Needle scaler**

▶ Item no. 8696-540-005

## ▶ Technical specifications

- Weight: 3,000 g
- Idle speed: 3700 blows p / m
- Beats Per Minute: 9,000 BPM
- Vibration: 6.9 m / s<sup>2</sup>
- Air consumption: 280 l / min
- incl. plug nipple with 1/4 „male threa



02

**Replacement needles for needle scaler**

▶ Item no. 8696-540-015

## ▶ Technical specifications

- for needle scaler (Item No. 8696-540-005)
- Quantity per set: 19 pieces



03

**Mini oiler**

▶ Item no. 8696-550-006

## ▶ Technical specifications

- Can be used with most motorized pneumatic tools
- Automatic oiling to extend the service life of your pneumatic tools
- Refillable, capacity 5.5 cm<sup>3</sup>
- Compact design - to be attached directly to the tool
- Particularly light design
- Thread insert in the filler neck
- Air connection inlet: external thread 1/4 „
- Air connection outlet: internal thread 1/4 „
- Operating pressure 6 bar



04

**Filter pressure reducer**

▶ Item no. 8696-550-005

## ▶ Technical specifications

- Consists of filter pressure reducer and manometer
- Pressure display: 0.5 - 12 bar
- Air connection thread: 1/4 "
- Air passage: 1750 L / min
- Max. Pressure: 12 bar (1/4 ")
- Max. Working pressure: 10 bar (1/4 ")
- Filling capacity filter pressure reducer: 80 ml
- Temperature range: 5 ° C ~ 60 ° C
- Drainage capacity: 80ml
- Oil capacity: 150ml



05

**Maintenance unit**

▶ Item no. 8696-550-007

## ▶ Technical specifications

- 2-fold, consisting of filter pressure reducer, mist lubricator and manometer
- Air connection thread (1/2 ")?
- Air passage at 6.2 bar: 3000 L / min
- Filling capacity filter pressure reducer: 80 ml
- Filling capacity of the mist lubricator: 150 ml
- Max. Pressure: 15.2 bar (1/2 ")
- Max. Working pressure: 10 bar (1/2 ")
- Pressure display: 0.5 - 12 bar
- Drainage capacity: 80ml
- Oil capacity: 150ml



01

**Pneumatic machine MBX**

ideal for foil erasers

▶ Item no. 4692-123

▶ Technical specifications

- Weight: 1.1 kg
- Thread air pressure conn:
- Speed: 0-3500 min-1
- Required flow pressure: 6
- average air consumption:



02

**MBX starter set**

for the professional processing of steel

▶ Item no. 4692-900

▶ Technical specifications

- Weight: 1.1 kg
- Thread air pressure connection: Rp 1/4 „
- Required hose diameter: 3/8 „ID (9.5 mm)
- Speed: 0-3500 min-1
- Required flow pressure: 6.2 bar / 90 psi
- required Inner tube diameter: 9.5 mm
- Average air consumption: 17.5 CFM (500 l / min.)
- Sound pressure level: 83 dB (DIN 45635-21; ISO 3744)?
- Content:
  - 1 x 4692-123 MBX pneumatic machine
  - 1 x 4692-211 MBX mounting system 1 mm
  - 1 x 4692-223 MBX mounting system 23 mm
  - 1 x 4692-523 MBX brush belt, coarse 23 mm
  - 1 x 4692-411 MBX brush belt, medium 11 mm
  - 1 x 4692 311 MBX fine brush belt 11 mm
  - 1 x 4692-800 MBX foil eraser



03

**Tornador Gun Classic**

▶ Item no. 8696-560-002

▶ Technical specifications

- stronger impulse - more power - better cleaning
- integrated compressed air regulator
- integrated joint nipple
- ergonomic, cold-insulated and low-vibration
- suitable for 2.2 kW - 240 V piston compressors
- designed for continuous professional use



04

**Tornador Gun Black**

▶ Item no. 8696-560-001

▶ Technical specifications

- particularly fine micro-atomization
- integrated compressed air regulator
- integrated joint nipple
- with proven Tornador® hose technology
- ergonomic, cold-insulated and low-vibration
- for 2.2kW - 230V piston compressors



05

**1/4 "flexible compressed air connection for Tornador Gun Black**

▶ Item no. 8696-560-003





01

**Blowgun long variable**

- ▶ Item no. 8696-550-001
- ▶ Technical specifications
  - swivel angle 360 °
  - easy and simple operation
  - Inlet with metal reinforcement
  - Material POM, steel
  - maximum pressure: 12 bar
  - Extendable tube: 270 mm - 400 mm
  - incl. 1/4 „nipple



02

**Blowgun 100mm**

- ▶ Item no. 8696-550-002
- ▶ Technical specifications
  - Easy and simple operation
  - Inlet with metal reinforcement
  - Material POM, steel
  - Length: 100mm
  - maximum pressure: 12 bar
  - incl. 1/4 „nipple



03

**Blowgun long nozzle**

- ▶ Item no. 8696-550-004
- ▶ Technical specifications
  - easy and simple to use
  - Inlet with metal reinforcement
  - Material POM, steel
  - maximum pressure: 15bar
  - Length: 250mm



04

**Blow out Pen**

- ▶ Item no. 8696-550-003
- ▶ Technical specifications
  - Material: aluminum
  - maximum pressure: 6.2Bar



05

**Compressed air blow gun with 1/4 „connection**

- ▶ Item no. 8696-113-90
- ▶ Technical specifications
  - Nozzle length: 22.0 cm



06

**Compressed air blow gun with 1/4 „connection**

- ▶ Item no. 8696-113-9
- ▶ Technical specifications
  - Nozzle length: 2.5 cm



07

**Compressed air blow gun with metal nozzle**

- ▶ Item no. 8696-113-900
- ▶ Technical specifications
  - Nozzle: 110 mm long
  - Diameter 3 x 6 mm
  - light
  - robust and scratch-resistant
  - Base: 23 Nm 3 / h at 6 bar
  - Inlet connection with brass insert 1/4 „IG toothed



01

**Pressure cup gun**  
for 1000 ml screw cans

▶ Item no. 2891-106-841

▶ Technical specifications

- for processing bottom guard and protector
- diverse structures can be injected
- Teflon seals
- suitable for metal



02

**Cavity spray hose set**  
for compressed air pressure cup gun

▶ Item no. 2891-106-842

▶ Technical specifications

- especially for the processing of Protector
- Hose Ø: 6 mm
- Hose length: 98 cm (with handle, including adapter), 116 cm (without handle, including adapter)



03

**Gun for underbody protection**  
including nozzles and riser pipe

▶ Item no. 2892-880

▶ Technical specifications

- fast



04

**Nozzle set for UBS pistol**  
for UBS pistol (Article No. 2892-880)

▶ Item no. 2892-880-1

- Nozzle set for UBS pistol (Article No. 2892-880)?
- Content:
- 3 x nozzles
- 3 x riser pipes





01

**Compressed air gun**

ideally suited for processing bodywork sealing compounds and window adhesives

## ▶ Item no. 2891-010

## ▶ Technical specifications

- Use of different cartridges possible
- universal use when using sealants and adhesives
- Immediate stop of the material flow through the quick exhaust valve
- 70% more power thanks to the piston technology compared to conventional compressed air guns
- Contents: cartridges from 300 ml to 320 ml, bagged goods up to 400 ml
- Mode of operation: pneumatic on 60 mm piston / push rod
- handle below
- Quick exhaust
- stable execution
- Pressure regulation unit
- Aluminum pistol
- high force development
- max.pressure: 10 bar
- Operating pressure: 5-10 bar



02

**Compressed air gun Multi**  
for 310 ml cartridges

## ▶ Item no. 2891-03

## ▶ Technical specifications

- for processing body sealants, window adhesives and sprayable seam seals
- Pistol body complete
- Connection type: plug-in spigot for coupling DN 7.2
- Union nut for sprayable seam sealing
- Union nut for standard applications
- Weight: 1.65 kg
- Min./max.compressed air supply: max. 10 bar
- Operating pressure: 0 - 7 bar
- Max diameter: 50 mm
- Max length: 220 mm
- Cartridge volume: approx. 310 ml
- Ambient temperature: 0 - 60 ° C



03

**Compressed air cartridge gun**

## ▶ Item no. 2891-05

## ▶ Technical specifications

- for processing sprayable seam seals
- incl. 10 long and 20 short nozzles



04

**Replacement spray tube**

for compressed air cartridge gun (Item No. 2891-05)

## ▶ Item no. 2891-051

## ▶ PU: 30



05

**Replacement nozzles for sprayable seam seals**

for multi-compressed air gun (item no. 2891-03)

## ▶ Item no. 2891-03-1

## ▶ PU: 10

## ▶ Technical specifications

- for processing body sealants, window adhesives and sprayable seam seals



01

**PVC hose**

With thermoplastic layers

## ► Technical specifications

- Temperature resistance -20 ° C to 60 ° C



Item No.	O inside Outside	length
8699-66-50	6,3 mm x 11,0 mm	50 m
8699-69-50	9,0 mm x 14,5 mm	50 m
8699-613-50	12,7 mm x 19,0 mm	50 m

02

**PVC hose fitting**

with thermoplastic layers

## ► Technical specifications

- with safety quick coupling and plug-in socket
- Temperature resistance -20 ° C to 60 ° C
- long lifetime
- lock, shock and crush resistant
- light and flexible



Item No.	O inside Outside	length
8699-201-6	6,3 mm x 11,0 mm	10 m
8699-201-9	9,0 mm x 14,5 mm	10 m
8699-201-13	12,7 mm x 19,0 mm	10 m

03

**Antistatic hose**

suitable for paint shops

## ► Technical specifications

- with safety quick coupling and plug-in socket
- Inside: 9 mm
- Outside: 16 mm
- Operating pressure: max. 20 bar
- Length: 10 m
- Operating temperature: max. 95 ° C
- 
- Conductivity: electrical resistance <106 Ohm / m
- Inner layer: Smooth black EPDM
- Armature: synthetic mesh
- Outer jacket: Smooth blue EPDM
- Areas of application: Supply of spray guns, compressed air, spray booths



Item No.	O inside Outside	length
8699-201-916	9,0 mm x 16,0 mm	10 m

04

**Spiral hose**

Polyurethane spiral hoses

## ► Technical specifications

- with fixed and rotatable threaded connection

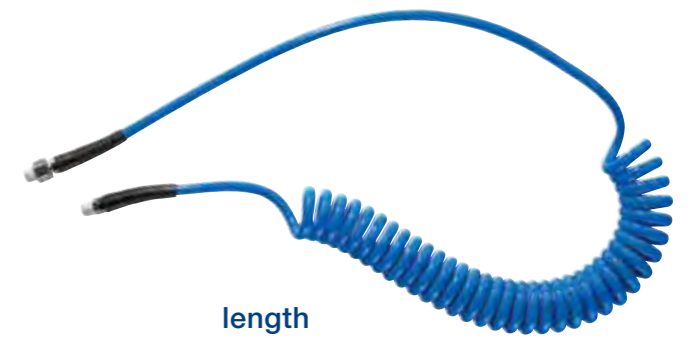

Item No.	O inside Outside	connection	length
8699-201-65	6,5 mm x 10,0 mm	1/4"	6 m
8699-201-8	8,0 mm x 12,0 mm	3/8"	8 m

05

**PTFE tape 12mm x 12m**

for thread sealing

## ► Item no. 3985-030-160

## ► Technical specifications

- Width: 12mm
- Length: 12 m
- Thickness: 0.1mm
- Heat-resistant up to 240 - 250 ° C





01

**Safety coupling**

European profile 7.2 - 7.4 mm

► **Technical specifications**

- Safe coupling and uncoupling thanks to decompression mechanism ISO 4414 - DIN EN 983
- minimal effort when coupling
- optimal tightness
- excellent flow that adapts to all air tools
- antistatic, avoids the attraction of dust particles to the work surface when applying paint
- Energy-absorbing composite material protects against scratches
- high resistance to abrasion, impacts, crushing, vibrations
- max.operating pressure: 16 bar
- Operating temperature: -15 ° C to 70 ° C

Item No.	designation	connection	Illustration
8699-200-16	Safety coupling with hose fitting	6,0 mm	1
8699-200-19	Safety coupling with hose fitting	9.0 mm	1
8699-200-113	Safety coupling with hose fitting	13.0 mm	1
8699-200-214	Safety coupling with external thread	1/4"	2
8699-200-238	Safety coupling with external thread	3/8 „	2
8699-200-212	Safety coupling with external thread	1/2"	2
8699-200-314	Safety coupling with internal thread	1/4"	3
8699-200-338	Safety coupling with internal thread	3/8"	3
8699-200-312	Safety coupling with internal thread	1/2"	3



1



2





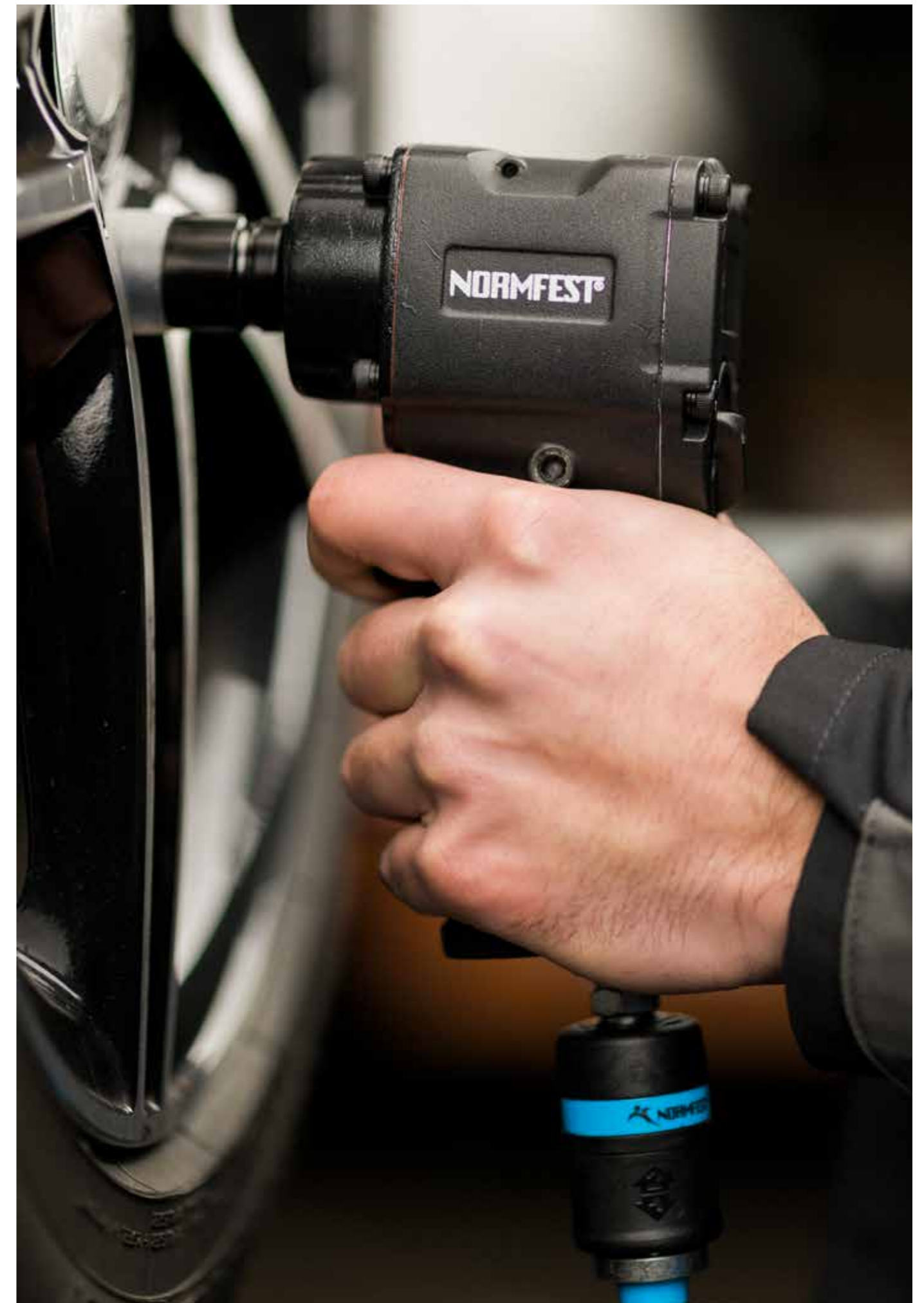

3





01

**Single-hand quick-connection coupler**

Item No.	Air connection mm	Key-width	Length	execution	image
8699-506	6	21	58		
8699-509	9	21	58		
8699-514	G 1/4	22	41	with internal thread	
8699-541	G 1/4	22	39	with external thread	

02

**Barbed nipple male thread brass**

Item No.	Air connection mm	Key-width	Length	image
8699-520-14	1/4"	17	33	
8699-520-38	3/8"	19	33	
8699-520-12	1/2"	24	38	



03

**Double distributor internal thread**

Item No.	Air connection mm	Length	image
8699-530	G 3/8	67	



04

**Double socket**

Item No.	Air connection mm	Key-width	Length	image
8699-56	6		72	
8699-59	9		72	



05

**Double hose nozzle brass**

Item No.	Air connection mm	Length	image
8699-25-551	Ø 9	54	
8699-25-552	Ø 13	51,5	

06



**Plug-type grommet hose connection**

Item No.	Air connection mm	Length	image
8699-526	6	48	
8699-529	9	48	





01

**Plug nipple with external thread**

Item No.	Air connection mm	Key-width	Length	image
8699-25-531	1/4"	14	37	
8699-25-532	3/8"	17	37	
8699-25-533	1/2"	22	43	

02

**Plug nipple with internal thread**

Item No.	Air connection mm	Key-width	Length	image
8699-200-714	1/4"	15	40	
8699-200-738	3/8"	21	41	
8699-200-712	1/2"	27	41	

03

**Plug nipple female thread steel**

Item No.	Air connection mm	Key-width	Length	image
8699-510-14	G 1/4	17	33	



04

**Double manifold male thread**

Item No.	Air connection mm	Key-width	Length	image
8699-200-702	1/2"	25	53	

05

**Plug-type grommet hose connection**

Item No.	Air connection mm	Length	image
8699-25-520	Ø 6	44,5	
8699-25-521	Ø 9	54	
8699-25-522	Ø 13	51,5	







01

**Angle grinder 2000 watt Ø230 mm standard**

▶ Item no. 7983-006-1

## ▶ Technical specifications

- Power: 2,000 watts
- Speed: 6,600 rpm
- for disc Ø: 230 mm
- Spindle: M 14
- Weight: 5.6 kg
- Packing: carton
- Scope of delivery: machine WITHOUT accessories
- Soft start
- Endurance lock

- Restart protection
- Anti-twist protective cover
- Dust protection
- Additional anti-vibration handle
- Magnesium gear housing
- Switch-off carbon brushes



02

**Protective cover for angle grinder  
Ø230mm**

▶ Item no. 7983-000-302

## ▶ Technical specifications

- for angle grinder item no. 7983-006-1



03

**Cordless impact wrench 1/2 „18V 5Ah standard**

▶ Item no. 7983-007-1

## ▶ Technical specifications

- Voltage / power: 18V / 5Ah
- Speed: 0-1,650 rpm
- Max. Torque: 588Nm
- Number of strokes / min: 2,100
- Weight including battery: 3.11kg
- Recording: 1/2 „
- Packaging: case
- 
- Battery charge status: shows the remaining capacity at the push of a button
- 0% -25% 1 LED
- 26% -50% 2 LED
- 51% -75% 3 LED
- 76% -100% 4 LED
- 
- Scope of delivery: case / a 5Ah battery / quick charger / operating instructions / battery impact wrench



01

**Eccentric polishing machine**

Tornador Ø 150 mm

▶ Item no. 8697-114-13

▶ Technical specifications

- max. polishing pad Ø: 180 mm
- max. support pad Ø: 150 mm
- Speeds: 1700-4200 rpm
- Eccentric stroke: 21 mm
- Power output: 900W
- 10 meters of cable
- stepless adjustable speed
- removable additional handle 240V / 50Hz
- Weight: 4.28 kg



02

**Velcro plate**

for eccentric polishing machine

▶ Item no. 8697-114-132

▶ Technical specifications

- Ø 150 mm



03

**Window cutter**

FEIN MULTIMASTER MM700

▶ Item no. 8697-6

▶ Technical specifications

- for removing glass from glued windows and working on the body
- Anti-vibration system (up to 70% less vibrations thanks to complete decoupling of the outer motor housing)
- permanently safe working
- permanent and overload-proof
- High-performance motor with a high copper content
- outstanding cutting speed
- Tachometer generator
- constant speeds even under load
- stepless electronic speed setting
- Metal gear (high load capacity and maximum service life)
- large action radius (5m fine-stranded rubber cable)
- Nominal consumption 450 W
- Power output 250 W

- Vibrations 10,000-19,500 rpm
- Hexagon tool holder
- Manual tool change with hexagon socket screw
- Amplitude 2 x 1.7 degrees
- 5 m cable with plug
- Weight according to EPTA 1.45 kg

- Scope of delivery:

- 1 x MULTIMASTER window cutter
- 1 x plastic tool case
- 1 x sharpening stone (Art.:8697-5-1)
- 1 x tensioning screw



04

**Round saw blade, fine**

▶ Item no. 8697-580-2

▶ Ø: 63 mm

▶ Packing unit: 1

▶ Item no. 8697-581-2

▶ Ø: 80 mm

▶ Packing unit: 1





01

**Hot air gun**

2,300 W for hot air from 80-650 ° C

▶ Item no. 8697-000-992

## ▶ Technical specifications

- Power: 2,300W
- Temperature: 80 ° C-650 ° C
- Temperature display: display, in 10 ° C steps
- Air volume: 150-500 l / min
- Heating: ceramic heating
- Thermal protection shutdown: yes
- Protection class (without protective conductor connection): II
- Dimensions (LxWxH): 253 x 86.5 x 200 mm
- Mains connection: 230 V, 50/60 Hz
- Weight: 0.755 kg (without power cord)

**Repair nozzle**

▶ Item no. 2701-10

**Reducing nozzle**

▶ Item no. 2701-11



02

**Hot glue gun**

electronically regulated

▶ Item no. 8714-607-1

## ▶ Technical specifications

- Bonding point is firm and resilient after approx. 2 minutes.
- high melting capacity
- Changeable nozzle
- electronic temperature control through modern PTC heating technology
- easy handling thanks to the mechanical feed device for glue sticks



03

**Mavro blind rivet nut pliers**

Including M6, M8, M10, M12 threaded mandrels and nuts

▶ Item no. 8948-800

## ▶ Technical specifications

- Hand tool for processing blind rivet nuts
- readable stroke scale
- little effort required
- Setting the rivet in hard-to-reach places
- Quick change system for mandrels and sleeves
- for processing blind rivet nuts M6 M8 M10 M12 aluminum / steel / stainless steel
- Working range: up to Ø 12 mm
- Weight: 1.1 kg
- Total length: 210 mm

## - Areas of application:

- e.g. : convertible roof fastenings, roof rails, AUDI license plate amplifiers, flaps on truck rear doors, truck door hinges, everywhere in vehicle construction for special vehicles and superstructures, assembly of various reinforcement plates on car bodies and machines, caravan construction etc.



04

**Threaded mandrel and nut**

for blind rivet nut pliers 8948-800



Item No.	execution	PU
8948-800-14	M4	1
8948-800-15	M5	1
8948-800-16	M6	1

01

**Cordless cartridge gun**

▶ Item no. 8715-999-110

▶ Technical specifications

- Voltage: 10.8V
- Propulsion force: 450kp
- Speed (mm / sec): 10mm / sec
- Weight: 2.195kg (battery 0.185kg)
- Charging time: 1 hour, automatic shutdown
- High-torque motors with 10.8 V.
- Patented high torque mechanism
- Patented mechanism for drip-free work
- Patented release mechanism
- Stepless speed control
- Autostop function
- Scope of delivery: pistol and battery



02

**Bag adapter**

for battery cartridge gun

▶ Item no. 8715-999-109



03

**Replacement battery**

▶ Item no. 8715-999-111

▶ Technical specifications

- Replacement battery for our cordless cartridge guns item no. 8715-999-110 and 8715-999-106



04

**Replacement battery charger**

for cordless cartridge gun

▶ Item no. 8715-999-112

▶ Technical specifications

- 10.8 V lithium-ion
- IP 30
- 100-240 V
- Display of the battery status by LEDs:
  - Device switched on (green LED flashes slowly)
  - Battery level low (red LED lights up continuously)
  - Battery 80% charged (green LED flashes quickly)
  - Battery 100% charged (green LED lights up continuously)



05

**Light pressure hand gun**

for processing cartridges and bag sealants up to 400 ml

▶ Item no. 2891-04

▶ Technical specifications

- Tear-proof metal locking ring with bayonet lock
- no jamming of the piston pressure rod due to the reinforced push plate
- for bag and cartridge goods



06

**Handsaw blade**

HSS bi-metal, single-edged

▶ Technical specifications

- wear-resistant, unbreakable, with excellent edge retention
- recommended for all materials



Item No.	Length [mm]	Width (mm)	Height mm	Teeth on 1 „	PU
4601-300-13	300	13	0,6 mm	24	10

07

**Handsaw blade**

HSS bi-metal, double-edged

▶ Technical specifications

- serrated on both sides
- Tooth pitch 22
- wear-resistant
- unbreakable
- with excellent edge retention
- recommended for all materials



Item No.	Length [mm]	Width (mm)	Height mm	Teeth on 1 „	PU
4601-300-25	300	25	0,8 mm	22	10



01

**Water pump pliers set**

Cobra

► Item no. 8714-02-08

► Technical specifications

- Set content:
  - 1 x water pump pliers 180 mm (8714-02-05)
  - 1 x water pump pliers 250 mm (8714-02-06)
  - 1 x water pump pliers 400 mm (8714-02-07)
  -
- Self-locking on pipes and nuts: no slipping on the workpiece, energy-saving work
- Push-through joint: high stability thanks to double guidance
- Pinch protection prevents crush injuries
- Chrome vanadium, forged, oil-hardened



02

**Water pump pliers**

Cobra

► Technical specifications

- Adjustment at the touch of a button directly on the workpiece
- Fine adjustment for optimum adaptation to different workpiece sizes and hand-friendly handle position
- Self-clamping on pipes and nuts: no slipping on the workpiece, effort-saving work
- Gripping surfaces with specially hardened teeth
- hardness of the teeth approx. 61 HRC: permanently secure gripping due to high wear resistance
- Through-hole joint: high stability due to double guidance
- secure locking of the hinge pin: no unintentional adjustment
- Pinch protection prevents crushing injuries
- Chrome vanadium electric steel, forged, oil-hardened
- Pliers grey atramentised with polished head
- Handles coated with non-slip plastic



Item No.	Length [mm]	Pipe Ø	Key-width
8714-02-05	180	1 ¼"	up to 30 mm
8714-02-06	250	2"	up to 46 mm
8714-02-07	400	3 ½"	up to 95 mm
8714-02-09	560	4 ½"	up to 120 mm



03

**Upholstery clamp pliers**

► Item no. 8714-02-10

► Technical specifications

- Groove to stabilise the upholstery clamp
- Reversible spring, ensures firm hold of the upholstery clamp



04

**Spring band clamp pliers**

250mm

► Item no. 8714-02-11

► Technical specifications

- rotating, universal gripping inserts for a secure grip of the clamps in every position
- Gripping inserts can also be rotated under load
- Extremely good leverage with which clamps can be opened easily and safely with little effort
- slender head; small head width, rotatable gripping inserts: an ideal tool especially in confined spaces
- Additional function: gently loosen hoses with a serrated gripping jaw
- Chrome vanadium electric steel, forged, oil-hardened
- Quick-Set adjustment: adjustment by pushing directly onto the workpiece
- Can be used for standard, space-saving and wire clamps as well as spring band rings up to 70 mm nominal size
- more than 40 mm clamping path
- Pliers: gray atramentized
- Handles: covered with non-slip plastic
- Capacity: max. 70 mm
- Setting positions: 25
- Length: 250 mm
- Net weight: 340 g
- Areas of application: air intake, cooling, charge air, water return, thermostat, fuel, heating



01

**Thread cutting set**

for metric threads according to DIN 13, 44 pieces

► Item no. 8639-02

► Technical specifications

- Contents: 44 parts
- 3 pieces each hand taps DIN 352, HSSG: M3, M4, M5, M6, M8, M10, M12
- 1 piece each DIN 223, HSS: M3, M4, M5, M6, M8, M10, M12
- 1 piece each adjustable tap wrench DIN 1814: size 1 and 2
- 1 piece each die holder DIN 225: 20 x 5 mm, 20 x 7 mm, 25 x 9 mm, 30 x 11 mm, 38 x 14 mm
- 1 piece of core hole twist drill DIN 338, HSS: 2.5 mm, 3.3 mm, 4.2 mm, 5.0 mm, 6.8 mm, 8.5 mm, 10.2 mm
- 1 piece each screwdriver and thread gauge



02

**Adjustable tap wrench**

DIN 1814, for hand taps with Square according to DIN10 and ISO / R237



Item No.	Length [mm]	For thread	For 4 KT.
8657-1	180	M1 - 10	2,1 - 5,5
8657-2	280	M4 - 12	3,8 - 7,0
8657-3	390	M5 - 20	4,9 - 12,0

03

**Tool holder with ratchet**

long version, for hand taps for right and left hand



Item No.	Length [mm]	For thread	For 4 KT.
8715-42-03	250	M3 - 8	2,4 - 4,9
8715-42-04	300	M8 - 12	4,9 - 7,0

04

**Tool holder with ratchet**

short version, for hand taps - for right and left-hand rotation



Item No.	Length [mm]	For thread	For 4 KT.
8715-42-01	85	M3 - 8	2,4 - 4,9
8715-42-02	100	M8 - 12	4,9 - 7,0



01

**Hand tap sets**

DIN 352 HSS, metric ISO standard thread, pre-, middle- and finishing tap

Item No.	thread	PU
PU8639-4	M4	1
8639-5	M5	1
8639-6	M6	1
8639-8	M8	1
8639-10	M10	1
8639-12	M12	1
8639-14	M14	1
8639-16	M16	1
8639-18	M18	1



02

**Pre-cutter**

DIN 352 HSS

Item No.	thread	PU
8640-1-6	M6	1
8640-1-7	M7	1
8640-1-8	M8	1
8640-1-10	M10	1
8640-1-20	M20	1
8640-1-22	M22	1
8640-1-24	M24	1



03

**Middle cutter**

DIN 352 HSS

Item No.	thread	PU
8640-2-5	M5	1
8640-2-6	M6	1
8640-2-8	M8	1
8640-2-10	M10	1
8640-2-18	M18	1
8640-2-20	M20	1
8640-2-24	M24	1



04

**Finishing cutter**

DIN 352 HSS

Item No.	thread	PU
8640-3-4	M4	1
8640-3-5	M5	1
8640-3-6	M6	1
8640-3-8	M8	1
8640-3-10	M10	1
8640-3-12	M12	1
8640-3-20	M20	1
8640-3-22	M22	1



05

**Hand tap sets**

DIN 2181 HSS, metric ISO fine thread, Pre-cutter, finish cutter

Item No.	thread	PU
8641-8-1	M8	1
8641-10-1	M10	1
8641-10-125	M10	1
8641-12-125	M12	1
8641-12-15	M12	1
8641-14-125	M14	1
8641-14-15	M14	1
8641-16-15	M16	1
8641-18-15	M18	1



06

**Fine Thread Pre-Cutter**

DIN 2181 HSS

Item No.	thread	PU
8642-118-15	M18	1
8642-124-15	M24	1



07

**Fine thread finishing cutter**

DIN 2181 HSS

Item No.	thread	PU
8642-310-1	M10 x 1,00	1
8642-310-125	M10 x 1,25	1
8642-312-125	M12 x 1,25	1
8642-312-15	M12 x 1,50	1
8642-314-125	M14 x 1,25	1
8642-314-15	M14 x 1,50	1

**Thread data declaration**

DIN 352 HSS, for metric ISO standard threads

Thread	pitch mm	core hole diam. mm	L mm	threaded length mm	shaft mm	4 kt. diam.
M4	0.70	3.3	45	14	4.5	3.4
M5	0.80	4.2	48	16	6.0	4.9
M6	1.00	5.0	50	19	6.0	4.9
M7	1.00	6.0	50	19	6.0	4.9
M8	1.25	6.8	56	22	6.0	4.9
M10	1.50	8.5	70	24	7.0	5.5
M12	1.75	10.2	75	29	9.0	7.0
M14	2.00	12.0	80	30	11.0	9.0
M16	2.00	14.0	80	32	12.0	9.0
M18	2.50	15.5	95	40	14.0	11.0
M20	2.50	17.5	95	40	16.0	12.0
M22	2.50	19.5	100	40	18.0	14.5
M24	3.00	21.0	110	50	18.0	14.5

**Thread data declaration**

DIN 2181 HSS, for metric ISO Fine thread

Thread	pitch mm	core hole diam. mm	L mm	threaded length mm	shaft mm	4 kt. diam.
M4	0.70	3.3	45	14	4.5	3.4
M5	0.80	4.2	48	16	6.0	4.9
M6	1.00	5.0	50	19	6.0	4.9
M7	1.00	6.0	50	19	6.0	4.9
M8	1.00	6.8	56	22	6.0	4.9
M10	1.50	8.5	70	24	7.0	5.5
M12	1.75	10.2	75	29	9.0	7.0
M14	2.00	12.0	80	30	11.0	9.0
M16	2.00	14.0	80	32	12.0	9.0
M18	2.50	15.5	95	40	14.0	11.0
M20	2.50	17.5	95	40	16.0	12.0
M22	2.50	19.5	100	40	18.0	14.5
M24	3.00	21.0	110	50	18.0	14.5

01

**Die nut**

DIN 223 HSS, for metric? ISO standard thread according to DIN 13  
Version B (closed, pre-slotted)

Item No.	thread	pitch mm	Ø mm	Height mm
8652-6	M6	1,00	20	7
8652-8	M8	1,25	25	9
8652-10	M10	1,50	30	11
8652-12	M12	1,75	38	14



02

**Die nut**

DIN 223 HSS, for metric? ISO fine thread according to DIN 13  
Version B (closed, pre-slotted)

Item No.	thread	pitch mm	Ø mm	Height mm
8652-10-125	M10	1,25	30	11
8652-12-125	M12	1,25	38	11
8652-12-15	M12	1,50	38	10
8652-14-15	M14	1,50	38	10
8652-16-15	M16	1,50	45	14
8652-22-15	M22	1,50	55	16



03

**Die holder**

DIN 225 for direct mounting of the dies

Item No.	Suitable for	Die Ø
8659-5	M12 - 14	38 x 14,0

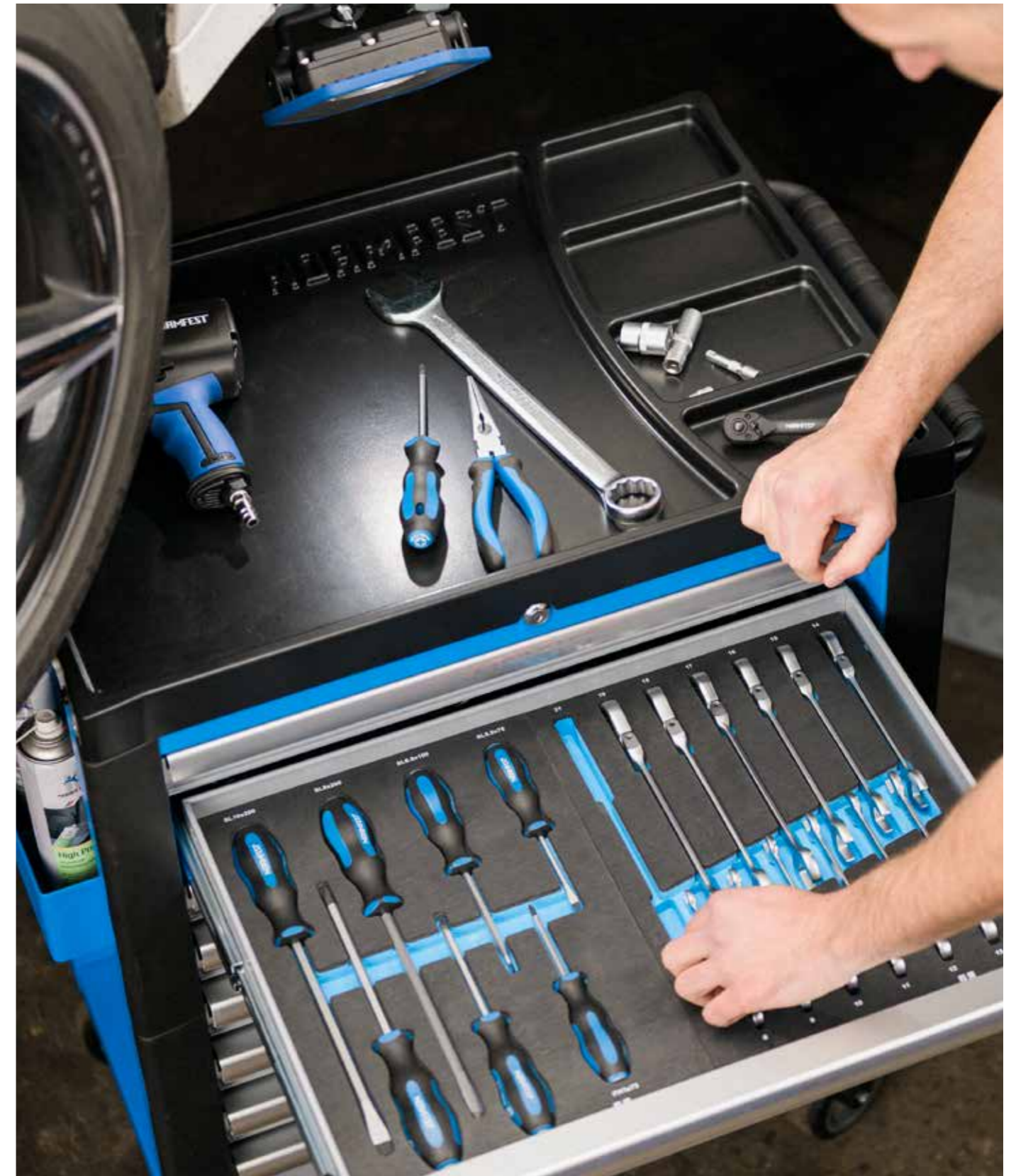



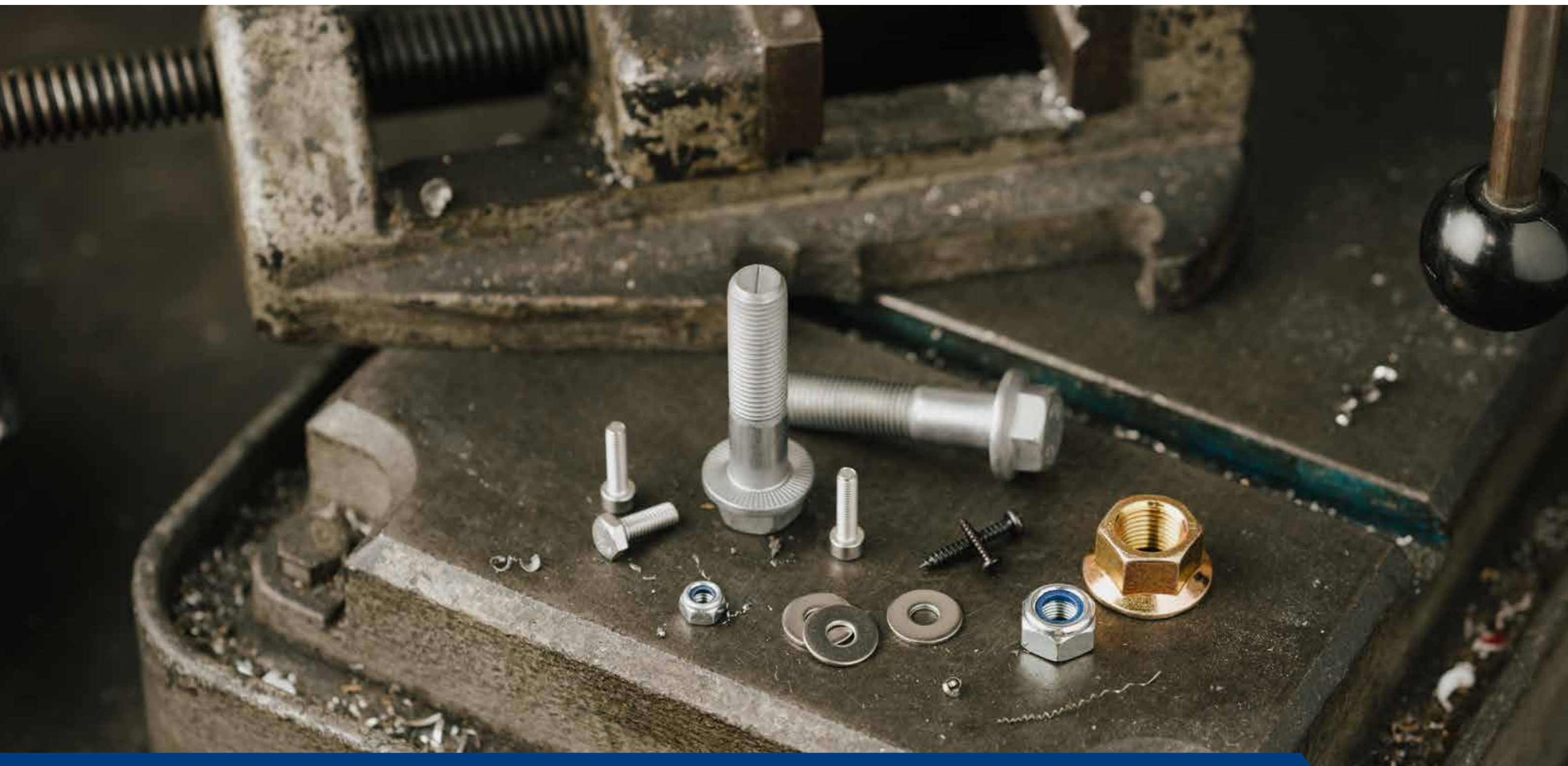

DIN and standardised parts

\*\*\*???

01  
**Geomet® hexagon head screws DIN 931**

- Technical specifications
- extreme weather resistance
- good temperature resistance
- Long-lasting corrosion resistance, even if the screws are used multiple times



02  
**Geomet® hexagon screws DIN 933**

- Technical specifications
- extreme weather resistance
- good temperature resistance
- Long-lasting corrosion resistance, even if the screws are used multiple times



03  
**Geomet® hexagon socket screws DIN 912**

- Technical specifications
- extreme weather resistance
- good temperature resistance
- Long-lasting corrosion resistance, even if the screws are used multiple times



04  
**Geomet® cheese head screws DIN 912 8.8**



Item No.	Thread-	length	Tensile strength in%	PU
O				
6032-6-51	M 6	50 mm		100
6032-6-50	M 6	50 mm	10.9	100
6032-8-100	M 8	100 mm		100
6032-10-65	M 10	65 mm		100
6032-12-55	M 12	55 mm		100
6032-12-70	M 12	70 mm	10.9	100
6032-16-70	M 16	70 mm	10.9	25
6032-16-75	M 16	75 mm	10.9	50
6032-16-90	M 16	90 mm	10.9	50
6032-16-110	M 16	110 mm	10.9	50
6032-20-65	M 20	65 mm	10.9	25
6032-20-75	M 20	75 mm	10.9	25
6032-30-120	M 30	120 mm	10.9	10
6032-30-150	M 30	150 mm	10.9	10

Item No.	Thread-	length	Tensile strength in%	PU
O				
6031-8-20	M 8	20 mm	10.9	100
6031-8-25	M 8	25 mm	10.9	100
6031-8-30	M 8	30 mm	10.9	100
6031-8-35	M 8	35 mm	10.9	100
6031-8-40	M 8	40 mm	10.9	100
6031-8-55	M 8	55 mm		100
6031-10-16	M 10	16 mm	10.9	100
6031-10-20	M 10	20 mm	10.9	100
6031-10-25	M 10	25 mm	10.9	100
6031-10-30	M 10	30 mm	10.9	100
6031-10-40	M 10	40 mm	10.9	100
6031-12-25	M 12	25 mm	10.9	50
6031-12-40	M 12	40 mm	10.9	50
6031-12-45	M 12	45 mm	10.9	50
6031-12-80	M 12	80 mm	10.9	50
6031-16-35	M 16	35 mm	10.9	50
6031-16-40	M 16	40 mm	10.9	50
6031-16-45	M 16	45 mm	10.9	50
6031-16-65	M 16	65 mm	10.9	50
6031-16-55	M 16	55 mm	10.9	50
6031-16-75	M 16	75 mm	10.9	50
6031-16-90	M 16	90 mm	10.9	50
6031-20-45	M 20	45 mm	10.9	25
6031-20-70	M 20	70 mm	10.9	25
6031-20-80	M 20	80 mm	10.9	25
6031-20-90	M 20	90 mm	10.9	25

Item No.	Thread-	length	Tensile strength in%	PU
O				
6030-5-40	M 5	40 mm	10.9	100
6030-6-25	M 6	25 mm	10.9	100
6030-6-30	M 6	30 mm	10.9	100

Item No.	Thread-	length	Tensile strength in%	PU
O				
6032-8-40	M 8	40 mm		100

This is how screws are measured correctly: Countersunk screw = total length / Other screw = up to the head



**01 Geomet® lock nuts DIN 980 FKL10**

- Technical specifications
- extreme weather resistance
- good temperature resistance
- Long-lasting corrosion resistance, even if the screws are used multiple times



Item No.	thread	PU6032-8
M 8		100
6032-10	M 10	100
6032-12	M 12	100
6032-16	M 16	100
6032-20	M 20	100
6032-30	M 30	25

**02 Lock washers**

- Technical specifications
- extreme weather resistance
- good temperature resistance
- Long-lasting corrosion resistance, even if the screws are used multiple times



Item No.	Ø in mm	PU6033-6
6		200
6033-8	8	200
6033-10	10	200
6033-12	12	200
6033-16	16	100
6033-20	20	100

**03 Geomet® washer DIN 125 form B**

- Technical specifications
- extreme weather resistance
- good temperature resistance
- Long-lasting corrosion resistance, even if the screws are used multiple times



Item No.	Ø in mm	PU6034-88
6034-30	30	25

**04 Geomet® spring washer DIN 6796**

- Technical specifications
- extreme weather resistance
- good temperature resistance
- Long-lasting corrosion resistance, even if the screws are used multiple times



Item No.	Ø in mm	PU6035-16
6035-20	20	50

**05 Sheet metal screw**

- Technical specifications
- Pan head with cross recess?
- DIN 8041 / ISO 7049?
- Galvanized? Property class 4.8



Item No.	Length	Head-Ø:	PU	
6115-29-95	2,9 mm	9.5 mm	5.6 mm	100
6115-35-13	3,5 mm	13 mm	6.9 mm	100
6115-35-16	3,5 mm	16 mm	6.9 mm	100
6115-35-19	3,5 mm	19 mm	6.9 mm	100
6115-35-95	3,5 mm	9.5 mm	6.9 mm	100
6115-39-13	3,9 mm	13 mm	7.5 mm	100
6115-39-16	3,9 mm	16 mm	7.5 mm	100
6115-39-19	3,9 mm	19 mm	7.5 mm	100
6115-42-13	4,2 mm	13 mm	8.2 mm	100
6115-42-16	4,2 mm	16 mm	8.2 mm	100
6115-42-19	4,2 mm	19 mm	8.2 mm	100
6115-42-22	4,2 mm	20 mm	8.2 mm	100
6115-42-25	4,2 mm	25 mm	8.2 mm	100
6115-42-38	4,2 mm	38 mm	8.2 mm	100
6115-42-95	4,2 mm	9.5 mm	8.2 mm	100
6115-48-13	4,8 mm	13 mm	9.5 mm	100
6115-48-16	4,8 mm	16 mm	9.5 mm	100
6115-48-19	4,8 mm	19 mm	9.5 mm	100
6115-48-22	4,8 mm	20 mm	9.5 mm	100
6115-48-25	4,8 mm	25 mm	9.5 mm	100
6115-48-32	4,8 mm	32 mm	9.5 mm	100
6115-48-95	4,8 mm	9.5 mm	9.5 mm	100
6115-55-13	5,5 mm	13 mm	10.8 mm	100
6115-55-16	5,5 mm	16 mm	10.8 mm	100
6115-55-19	5,5 mm	19 mm	10.8 mm	100
6115-55-38	5,5 mm	38 mm	10.8 mm	100
6115-63-16	6,3 mm	16 mm	12.5 mm	100
6115-63-19	6,3 mm	19 mm	12.5 mm	100
6115-63-22	6,3 mm	20 mm	12.5 mm	100
6115-63-25	6,3 mm	25 mm	12.5 mm	100
6115-63-60	6,3 mm	60 mm	12.5 mm	100

**06 LENS HEAD METAL SCREW**

- Technical specifications
- with Phillips cross recess (form H)
- DIN 7981 / ISO 7049
- black galvanized



Item No.	Length	Head-Ø:	PU	
6134-29-95	2,9 mm	9.5 mm	5.6 mm	100
6134-29-13	2,9 mm	13 mm	5.6 mm	100
6134-29-19	2,9 mm	19 mm	5.6 mm	100
6134-35-95	3,5 mm	9.5 mm	6.9 mm	100
6134-35-13	3,5 mm	13 mm	6.9 mm	100
6134-35-16	3,5 mm	16 mm	6.9 mm	100
6134-35-19	3,5 mm	19 mm	6.9 mm	100
6134-39-95	3,9 mm	9.5 mm	7.5 mm	100
6134-39-13	3,9 mm	13 mm	7.5 mm	100
6134-39-16	3,9 mm	16 mm	7.5 mm	100
6134-39-19	3,9 mm	19 mm	7.5 mm	100
6134-39-22	3,9 mm	20 mm	7.5 mm	100
6134-39-25	3,9 mm	25 mm	7.5 mm	100
6134-42-95	4,2 mm	9.5 mm	8.2 mm	100
6134-42-13	4,2 mm	13 mm	8.2 mm	100
6134-42-16	4,2 mm	16 mm	8.2 mm	100
6134-42-19	4,2 mm	19 mm	8.2 mm	100
6134-42-22	4,2 mm	20 mm	8.2 mm	100
6134-42-25	4,2 mm	25 mm	8.2 mm	100
6134-48-95	4,8 mm	9.5 mm	9.5 mm	100
6134-48-13	4,8 mm	13 mm	9.5 mm	100
6134-48-16	4,8 mm	16 mm	9.5 mm	100
6134-48-19	4,8 mm	19 mm	9.5 mm	100
6134-48-22	4,8 mm	20 mm	9.5 mm	100
6134-48-25	4,8 mm	25 mm	9.5 mm	100
6134-55-16	5,5 mm	16 mm	10.8 mm	100
6134-55-19	5,5 mm	19 mm	10.8 mm	100
6134-55-25	5,5 mm	25 mm	10.8 mm	100

This is how screws are measured correctly: Countersunk screw = total length / Other screw = up to the head

01

**Flat-head tapping screw**

- ▶ **Technical specifications**
- with Phillips cross recess (form H), collar and point
- similar to DIN 7981
- black galvanized



02

**Self-tapping screws with collar, black galvanized**

- ▶ **Technical specifications**
- with Phillips cross recess (form H) with collar and drill point
- DIN 7981 / ISO 7049
- black galvanized



03

**Hexagon head sheet metal screws with washer**

- ▶ **Technical specifications**
- with washer
- DIN 7976 B
- galvanized



Item No.	Length	Head-Ø:	PU
6134-039-95	3,9 mm	9.5 mm	100
6134-039-13	3,9 mm	13 mm	100
6134-039-16	3,9 mm	16 mm	100
6134-039-19	3,9 mm	19 mm	100
6134-039-22	3,9 mm	20 mm	100
6134-039-25	3,9 mm	25 mm	100
6134-039-38	3,9 mm	38 mm	100
6134-042-95	4,2 mm	9.5 mm	100
6134-042-13	4,2 mm	13 mm	100
6134-042-16	4,2 mm	16 mm	100
6134-042-19	4,2 mm	19 mm	100
6134-042-22	4,2 mm	20 mm	100
6134-042-25	4,2 mm	25 mm	100
6134-042-38	4,2 mm	38 mm	100
6134-048-95	4,8 mm	9.5 mm	100
6134-048-13	4,8 mm	13 mm	100
6134-048-16	4,8 mm	16 mm	100
6134-048-19	4,8 mm	19 mm	100
6134-048-22	4,8 mm	20 mm	100
6134-048-25	4,8 mm	25 mm	100
6134-048-32	4,8 mm	32 mm	100

Item No.	Length	Head-Ø:	PU	
6135-042-13	4,2 mm	13 mm	100	
6135-042-16	4,2 mm	16 mm	100	
6135-042-19	4,2 mm	19 mm	100	
6135-042-25	4,2 mm	25 mm	100	
6135-048-16	4,8 mm	16 mm	12.5 mm	100
6135-048-22	4,8 mm	20 mm	12.5 mm	100
6135-048-35	4,8 mm	35 mm	12.5 mm	100

Item No.	Length	Head-Ø:	PU	
6129-48-13	4,8 mm	13 mm	8 mm	100
6129-48-16	4,8 mm	16 mm	8 mm	100
6129-48-19	4,8 mm	19 mm	8 mm	100
6129-55-16	5,5 mm	16 mm	8 mm	100
6129-55-19	5,6 mm	19 mm	8 mm	100
6129-56-13	5,5 mm	13 mm	8 mm	100
6129-63-16	6,3 mm	16 mm	10 mm	100
6129-63-25	6,3 mm	20 mm	10 mm	100
6129-65-16	6,5 mm	16 mm	10 mm	100
6129-65-20	6,5 mm	20 mm	10 mm	100
6129-8-19	8,0 mm	19 mm	13 mm	100

This is how screws are measured correctly: Countersunk screw = total length / Other screw = up to the head



01

**Drilling screws with cross recess (DIN 7504)**

- Technical specifications
- with Phillips cross recess
- similar to DIN 7504-N
- galvanized



02

**Countersunk countersunk head drilling screws with Torx**

- Technical specifications
- Countersunk head, Torx drive T30?
- Galvanized



03

**Hex bolt**

- Technical specifications
- with collar and serration under the head - similar to DIN 7504-K - galvanized



04

**Chipboard screws with countersunk head and Torx**

- Technical specifications
- with Torx drive (T-Multidrive)
- galvanized



Item No.	Length	Head-Ø:PU	6211-35-95
3,9 mm	9,5 mm	6,9 mm	100
6211-35-13	3,5 mm	13 mm	6,9 mm 100
6211-35-16	3,5 mm	16 mm	6,9 mm 100
6211-35-19	3,5 mm	19 mm	6,9 mm 100
6211-39-13	3,9 mm	13 mm	7,5 mm 100
6211-39-16	3,9 mm	16 mm	7,5 mm 100
6211-39-19	3,9 mm	19 mm	7,5 mm 100
6211-42-13	4,2 mm	13 mm	8,2 mm 100
6211-42-16	4,2 mm	16 mm	8,2 mm 100
6211-42-19	4,2 mm	19 mm	8,2 mm 100
6211-42-22	4,2 mm	20 mm	8,2 mm 100
6211-42-25	4,2 mm	25 mm	8,2 mm 100
6211-48-13	4,8 mm	13 mm	9,5 mm 100
6211-48-16	4,8 mm	16 mm	9,5 mm 100
6211-48-19	4,8 mm	19 mm	9,5 mm 100
6211-48-22	4,8 mm	20 mm	9,5 mm 100
6211-48-25	4,8 mm	25 mm	9,5 mm 100
6211-48-32	4,8 mm	32 mm	9,5 mm 100
6211-48-45	4,8 mm	45 mm	9,5 mm 100
6211-55-19	5,5 mm	19 mm	10,8 mm 100
6211-55-22	5,5 mm	20 mm	10,8 mm 100
6211-63-19	6,3 mm	19 mm	10,8 mm 100
6211-63-22	6,3 mm	20 mm	10,8 mm 100
6211-63-25	6,3 mm	25 mm	10,8 mm 100

Item No.	Length	Head-Ø:PU	6212-55-38
5,5 mm	38 mm	12 mm	100
6212-55-45	6,3 mm	45 mm	12 mm 100
6212-55-55	6,3 mm	55 mm	12 mm 100
6212-63-60	5,5 mm	60 mm	12 mm 100
6212-63-70	5,5 mm	70 mm	12 mm 100
<b>Length Head-Ø:PU</b>			
38 mm	12 mm		100
6212-55-45	6,3 mm	45 mm	12 mm 100
6212-55-55	6,3 mm	55 mm	12 mm 100
6212-63-60	5,5 mm	60 mm	12 mm 100
6212-63-70	5,5 mm	70 mm	12 mm 100

Item No.	Length	Head-Ø:PU	6214-48-19
4,8 mm	19 mm	10,5 mm	100
6214-48-16	4,8 mm	16 mm	10,5 mm 100
<b>No. Length Head-Ø:PU</b>			
4,8 mm	19 mm	10,5 mm	100
6214-48-16	4,8 mm	16 mm	10,5 mm 100

Item No.	drive	thread	Length	PU	6198-00-16
	3,0 mm	16 mm	6 mm		300
6198-035-16		3,5 mm	16 mm	7 mm	300
6198-035-30		3,5 mm	30 mm	7 mm	300
6198-035-40		3,5 mm	40 mm	7 mm	300
6198-040-20		4,0 mm	20 mm	8 mm	300
6198-040-25		4,0 mm	25 mm	8 mm	300
6198-040-35		4,0 mm	35 mm	8 mm	300
6198-040-45		4,0 mm	45 mm	8 mm	300
6198-040-50		4,0 mm	50 mm	8 mm	300
<b>Length Head-Ø:PU</b>					
			194,8 mm	19	
6214-48-16	4,8 mm	16 mm	10,5 mm	100	Item No. drive
<b>thread Length PU</b>					
			6198-030-16	3,0 mm	300
6198-035-16		3,5 mm	16 mm	7 mm	300
6198-035-30		3,5 mm	30 mm	7 mm	300
6198-035-40		3,5 mm	40 mm	7 mm	300
6198-040-20		4,0 mm	20 mm	8 mm	300
6198-040-25		4,0 mm	25 mm	8 mm	300
6198-040-35		4,0 mm	35 mm	8 mm	300
6198-040-45		4,0 mm	45 mm	8 mm	300
6198-040-50		4,0 mm	50 mm	8 mm	300

This is how screws are measured correctly: Countersunk screw = total length / Other screw = up to the head

01

**Hexagon head screws (DIN 933 / ISO 4017)**► **Technical specifications**

- Thread up to the head
- DIN 933 / ISO 4017
- galvanized
- Strength class 8.8



Item No.	Length		PU	Item No.	Length		PU	Item No.	Length		PU	Item No.	Length		PU
6057-4-10	4 mm	10 mm	200	6057-6-35	6 mm	35 mm	200	6057-10-20	10 mm	20 mm	100	6057-12-80	12 mm	80 mm	50
6057-4-16	4 mm	16 mm	200	6057-6-40	6 mm	40 mm	200	6057-10-25	10 mm	25 mm	100	6057-12-90	12 mm	90 mm	50
6057-4-20	4 mm	20 mm	200	6057-6-45	6 mm	45 mm	200	6057-10-30	10 mm	30 mm	100	6057-12-100	12 mm	100 mm	25
6057-4-25	4 mm	25 mm	200	6057-6-50	6 mm	50 mm	200	6057-10-35	10 mm	35 mm	100	6057-14-35	14 mm	35 mm	25
6057-4-30	4 mm	30 mm	200	6057-6-55	6 mm	55 mm	100	6057-10-40	10 mm	40 mm	100	6057-14-40	14 mm	40 mm	25
6057-4-40	4 mm	40 mm	200	6057-6-60	6 mm	60 mm	100	6057-10-45	10 mm	45 mm	100	6057-14-45	14 mm	45 mm	25
6057-5-10	5 mm	10 mm	200	6057-6-70	6 mm	70 mm	50	6057-10-50	10 mm	50 mm	100	6057-14-50	14 mm	50 mm	25
6057-5-12	5 mm	12 mm	200	6057-6-80	6 mm	80 mm	50	6057-10-55	10 mm	55 mm	50	6057-14-60	14 mm	60 mm	25
6057-5-16	5 mm	16 mm	200	6057-8-10	8 mm	10 mm	200	6057-10-60	10 mm	60 mm	100	6057-14-70	14 mm	70 mm	25
6057-5-20	5 mm	20 mm	200	6057-8-12	8 mm	12 mm	200	6057-10-65	10 mm	65 mm	50	6057-14-80	14 mm	80 mm	25
6057-5-25	5 mm	25 mm	200	6057-8-16	8 mm	16 mm	200	6057-10-70	10 mm	70 mm	50	6057-14-100	14 mm	100 mm	25
6057-5-30	5 mm	30 mm	200	6057-8-20	8 mm	20 mm	200	6057-10-80	10 mm	80 mm	50	6057-14-120	14 mm	120 mm	25
6057-5-35	5 mm	35 mm	200	6057-8-25	8 mm	25 mm	200	6057-10-90	10 mm	90 mm	50	6057-16-30	16 mm	30 mm	25
6057-5-40	5 mm	40 mm	200	6057-8-30	8 mm	30 mm	200	6057-10-100	10 mm	100 mm	50	6057-16-40	16 mm	40 mm	25
6057-5-45	5 mm	45 mm	200	6057-8-35	8 mm	35 mm	200	6057-10-110	10 mm	110 mm	50	6057-16-50	16 mm	50 mm	25
6057-5-50	5 mm	50 mm	200	6057-8-40	8 mm	40 mm	100	6057-12-20	12 mm	20 mm	100	6057-16-55	16 mm	55 mm	25
6057-5-60	5 mm	60 mm	200	6057-8-45	8 mm	45 mm	100	6057-12-25	12 mm	25 mm	100	6057-16-60	16 mm	60 mm	25
6057-6-10	6 mm	10 mm	200	6057-8-50	8 mm	50 mm	100	6057-12-30	12 mm	30 mm	100	6057-16-70	16 mm	70 mm	25
6057-6-12	6 mm	12 mm	200	6057-8-55	8 mm	55 mm	100	6057-12-35	12 mm	35 mm	100	6057-16-80	16 mm	80 mm	25
6057-6-16	6 mm	16 mm	200	6057-8-60	8 mm	60 mm	100	6057-12-40	12 mm	40 mm	100	6057-16-100	16 mm	100 mm	25
6057-6-18	6 mm	18 mm	200	6057-8-65	8 mm	65 mm	100	6057-12-45	12 mm	45 mm	100	6057-16-120	16 mm	120 mm	25
6057-6-20	6 mm	20 mm	200	6057-8-70	8 mm	70 mm	50	6057-12-50	12 mm	50 mm	100	6057-20-35	20 mm	35 mm	25
6057-6-22	6 mm	20 mm	200	6057-8-75	8 mm	75 mm	50	6057-12-55	12 mm	55 mm	50	6057-20-55	20 mm	55 mm	25
6057-6-25	6 mm	25 mm	200	6057-8-80	8 mm	80 mm	50	6057-12-60	12 mm	60 mm	100				
6057-6-30	6 mm	30 mm	200	6057-10-16	10 mm	16 mm	100	6057-12-70	12 mm	70 mm	50				

This is how screws are measured correctly: Countersunk screw = total length / Other screw = up to the head



**01**  
**Lock screws with nut galvanized 655**

- ▶ **Technical specifications**
- with square set and hexagon nut
- Strength 4.8? DIN 603 / ISO 8677 galvanized



**02**  
**Ratchet screw**

- ▶ **Technical specifications**
- Quality 8.8 Galvanized Strength class 8.8



**05**  
**Hexagon socket screw**

- ▶ **Technical specifications**
- Cylinder head Quality 8.8? DIN 912 / ISO 4762? Galvanized



**06**  
**Allen screws DIN 912 A2**

- ▶ **Technical specifications**
- DIN 912 Cylinder head - Allen



Item No.	Length	Head-Ø:	PU
6223-10-40	40 mm	24 mm	100

Item No.	Thread	SW	Length	PU
6274-6-10	M 6	10 mm	10 mm	100
6274-6-16	M 6	10 mm	16 mm	100
6274-6-20	M 6	10 mm	20 mm	100
6274-6-25	M 6	10 mm	25 mm	100
6274-6-30	M 6	10 mm	30 mm	100
6274-8-20	M 8	13 mm	20 mm	100
6274-8-30	M 8	13 mm	30 mm	100
6274-8-40	M 8	13 mm	40 mm	100
6274-10-20	M 10	15 mm	20 mm	50
6274-10-30	M 10	15 mm	30 mm	50
6274-10-35	M 10	15 mm	35 mm	50
6274-10-50	M 10	15 mm	50 mm	50
6274-12-20	M 12	17 mm	20 mm	50
6274-12-30	M 12	17 mm	30 mm	50
6274-12-40	M 12	17 mm	40 mm	50

Item No.	thread	length	PU
6084-4-16	M 4	16 mm	100
6084-5-10	M 5	10 mm	100
6084-5-12	M 5	12 mm	100
6084-5-16	M 5	16 mm	100
6084-5-20	M 5	20 mm	100
6084-5-25	M 5	25 mm	100
6084-5-30	M 5	30 mm	100
6084-5-40	M 5	40 mm	100
6084-6-10	M 6	10 mm	100
6084-6-16	M 6	16 mm	100
6084-6-20	M 6	20 mm	100
6084-6-25	M 6	25 mm	100
6084-6-30	M 6	30 mm	100
6084-6-35	M 6	35 mm	100
6084-6-40	M 6	40 mm	100
6084-6-50	M 6	50 mm	100
6084-6-60	M 6	60 mm	100
6084-8-12	M 8	12 mm	100
6084-8-16	M 8	16 mm	100
6084-8-20	M 8	20 mm	100
6084-8-25	M 8	25 mm	100
6084-8-30	M 8	30 mm	100
6084-8-35	M 8	35 mm	100
6084-8-40	M 8	40 mm	100
6084-8-45	M 8	45 mm	100
6084-8-50	M 8	50 mm	100
6084-8-60	M 8	60 mm	100
6084-10-30	M 10	30 mm	100
6084-10-40	M 10	40 mm	100
6084-10-50	M 10	50 mm	100
6084-10-60	M 10	60 mm	50
6084-12-30	M 12	30 mm	50

Item No.	length	Head height	PU
6094-5-20	20 mm	5,0 mm	100
6094-6-20	20 mm	6.0 mm	100
6094-6-30	30 mm	6.0 mm	100
6094-6-40	40 mm	6.0 mm	100

**03**  
**License plate screws - self-tapping cap screws**

- ▶ **Technical specifications**
- for number plate attachment
- blue passivated (A2K)
- Head with additional adhesive groove for cover caps
- galvanized steel



**04**  
**Frame screws with fine thread**

- ▶ **Technical specifications**
- with fine thread
- grade 10.9 / steel
- galvanised



Item No.	thread	length	PU
6273-012-30	M 12 x 1,5	30 mm	25
6273-012-40	M 12 x 1,5	40 mm	25
6273-014-30	M 14 x 1,5	30 mm	25
6273-014-60	M 14 x 1,5	60 mm	25

Item No.	Length	drive	thread	PU
6104-48-13	13 mm	Phillips	4,8 mm	100
6104-48-16	16 mm	Phillips	4,8 mm	100
6104-48-19	19 mm	Phillips	4,8 mm	100

Features of hexagon socket screw:

M4 and M5 up to length 25 mm, only without shaft  
 M4 and M5 from length 30 mm, only with shaft  
 M6 to length 30 mm, only without shaft  
 M6 from length 35 mm, only with shaft  
 M8 to length 35 mm, only without shaft

M8 from length 40 mm, only with shaft  
 M10 to length 40 mm, only without shaft  
 M10 from length 45 mm, only with shaft  
 M12 to length 50 mm, only without shaft  
 M12 from length 55 mm, only with shaft

This is how screws are measured correctly: Countersunk screw = total length / Other screw = up to the head

**01 Hexagon head screws A2**

► Technical specifications  
- DIN 933 - thread to head



**02 Countersunk screws A2**

► Technical specifications  
- DIN 965 EN ISO 7046 With Phillips cross recess



**05 Poly stop nut A2**

► Technical specifications  
- DIN 985 / ISO 10511 „self-locking“ plastic ring



**06 Hex nuts A2**

► Technical specifications  
- DIN 934



Item No.	thread	length	PU
6096-6-16	M 6	16 mm	100
6096-6-20	M 6	20 mm	100
6096-6-30	M 6	30 mm	100
6096-8-20	M 8	20 mm	100
6096-8-25	M 8	25 mm	100
6096-8-30	M 8	30 mm	100
6096-8-40	M 8	40 mm	100

Item No.	Length	Head-Ø:	PU
6281-8-40	40 mm	14.5 mm	50

Item No.	execution	PU
6391-5	M 5	100
6391-6	M 6	100
6391-8	M 8	100
6391-10	M10	100
6391-12	M12	100

Item No.	execution	PU
6322-5	M5	100
6322-6	M6	100
6322-8	M8	100
6322-10	M10	100
6322-12	M12	50

**03 Pan head tapping screws A2**

► Technical specifications  
- DIN 7981? DIN ISO 7049? With Phillips cross recess



**04 Hexagon cap nuts A2**

► Technical specifications  
- DIN 1587



**07 Washers A2**

► Technical specifications  
- DIN 9021? EN ISO 7093? Outside diameter ~ 3x? Hole diameter



**08 Washers A2**

► Technical specifications  
- DIN 125? EN ISO 7089? Form A without bevel



Item No.	Thread	Length	PU
6119-35-95	3,50 mm	9.5 mm 6.9 mm	100
6119-35-13	3,50 mm	13 mm 6.9 mm	100
6119-35-16	3,50 mm	16 mm 6.9 mm	100
6119-42-13	4,20 mm	13 mm 8.2 mm	100
6119-42-16	4,20 mm	16 mm 8.2 mm	100
6119-42-19	4,20 mm	19 mm 8.2 mm	100
6119-42-25	4,20 mm	25 mm 8.2 mm	100
6119-48-13	4,80 mm	13 mm 8.2 mm	100
6119-48-16	4,80 mm	16 mm 8.2 mm	100
6119-48-19	4,80 mm	19 mm 8.2 mm	100
6119-48-22	4,80 mm	20 mm 8.2 mm	100
6119-48-25	4,80 mm	25 mm 8.2 mm	100

Item No.	execution	PU
6348-6	M6	100
6348-8	M8	100

Item No.	execution	PU
6419-5	5.3	100
6419-6	6,4 mm	100
6419-8	8.4	100
6419-10	10.5 mm	50

Item No.	execution	PU
6409-5	5.3	100
6409-6	6,4 mm	100
6409-8	8.4	100
6409-10	10.5 mm	50

This is how screws are measured correctly: Countersunk screw = total length / Other screw = up to the head



01

**Frame nut with fine thread**

- **Technical specifications**
- toothed DIN 6798 A quality 10.9 galvanized



Item No.	execution	PU
6273-012	M12	25
6273-014	M14	25
6273-016	M16	25

03

**Full metal lock nut**

- self-locking
- All metal
- increased frictional engagement due to deformation of the nut's clamping area
- DIN 980 / ISO 7042
- yellow chromated
- Strength class 10

► **Item no. 6369-0** (Art. no. x thread Ø x pitch)

05

**Hexagon nut**

- DIN 934 / ISO 4032
- galvanized
- Strength class 8

► **Item no. 6317** (Art. no. x thread Ø x pitch)

07

**Hexagon cap nut**

- high form
- DIN 1587
- galvanized
- Strength class 6

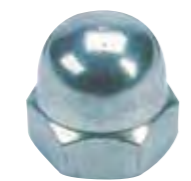
► **Item no. 6356** (Art. no. x thread Ø)

02

**Poly lock nut**

- self-locking
- All metal
- increased frictional engagement due to deformation of the nut's clamping area
- DIN 980 / ISO 7042
- yellow chromated
- Strength class 10

► **Item No. 6368** (Art. no. x thread Ø x pitch)

04

**Geomet® lock nuts DIN 980 FKL10**

- self-locking
- All metal
- increased frictional engagement due to deformation of the nut's clamping area
- DIN 980 / ISO 7042
- galvanized
- Strength class 10

► **Item no. 6369** (Art. no. x thread Ø)

06

**Hexagon nut with wave washer**

- Galvanised steel
- blue passivated (A2K)

► **Item no. 6379** (Art. no. x thread Ø)

08

**Locknuts vz**

- with collar and locking teeth
- similar to Din 6923
- galvanized
- Strength class 8

► **Item no. 6394** (Art. no. x thread Ø)

09

**Spring washers**

- Form B
- wavy
- DIN 137
- galvanized

► **Item no. 6435** (Art. no. x thread Ø)

11

**Fender washers**

- Tolerance according to DIN 522 C
- galvanized

► **Item no. 6411**  
(Art. no. x thread Ø)

13

**Serrated lock washers**

- Form A
- externally toothed
- DIN 6798
- galvanized

► **Item no. 6429** (Art. no. x thread Ø)

10

**Washer**

- Form A
- DIN 125 / ISO 7089
- galvanized
- Hardness class 140 HV

► **Item no. 6407** (Art. no. x thread Ø)

12

**Split washer**

- Form A
- bent up
- DIN 127
- galvanized

► **Item no. 6441** (Art. no. x thread Ø)

14

**Nord-Lock washers**

- Wedge lock washers NL NERD-LOCK
- glued in pairs
- Material: steel
- Surface: DELTA-PROTEKT
- d: 31.4 mm
- d1: 47 mm
- h: 5.8 mm
- PU: 50 PCS

► **Item no. 6032-30-1**

**01**  
**Linch pin**  
yellow chromated

Item No.	Shaft Ø [mm]	L in mm	PU
6472-45	4,5	40	10
6472-6	6	40	10
6472-8	8	40	10
6472-10	10	40	10

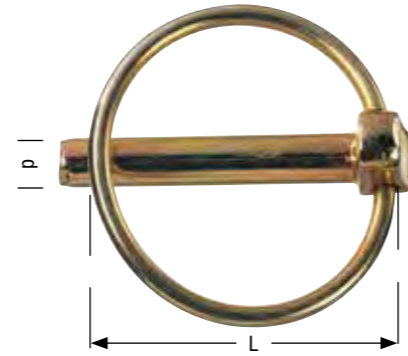

**02**  
**Spring clip**  
single turn galvanized

Item No.	d	Length (L)	D.	Hole Ø	Axles o. Shaft Ø D1	PU
6473-2-1	2	50	10	2,5	9 - 14	25
6473-3-1	3	60	18	3,5	10 - 16	25
6473-4-1	4	60	20	4,5	16 - 20	10
6473-5-1	5	85	24	6,0	20 - 28	10
6473-6-1	6	105	30	7,0	28 - 40	10
6473-8-1	8	110	28	9,0	30 - 45	10

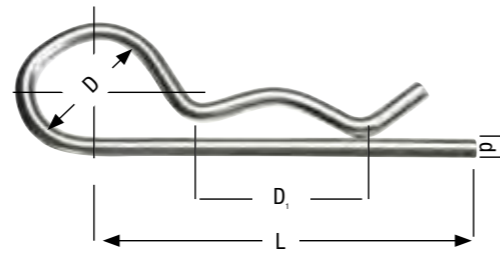

**03**  
**Spring clip**  
double turn - galvanized

Item No.	d	Length (L)	D.	Hole Ø	Axles o. Shaft Ø D1	PU
6473-2-3	2	50	10	2,5	8 - 14	25
6473-3-3	3	62	16	3,5	14 - 20	25
6473-4-3	4	78	23	4,5	17 - 24	10
6473-5-3	5	92	26	5,5	18 - 30	10
6473-6-3	6	120	30	6,5	24 - 36	10

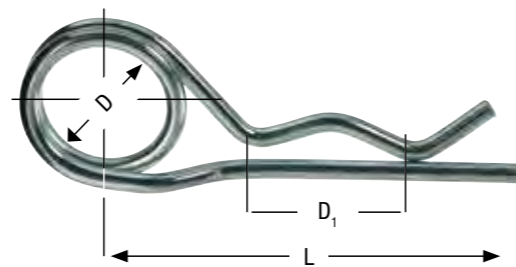

**04**  
**Cotter bolts**  
DIN 1434? Quality 10.9? Galvanized steel

Item No.	d Ø mm	L1 mm	L. mm	PU
6260-001-42	19	40	45	10



**05**  
**Threaded rods**  
DIN 975, 1 meter? Quality 8.8? Galvanized

Item No.	thread	PU
6958-5	M 5	1
6958-6	M 6	1
6958-8	M 8	1
6958-10	M 10	1
6958-12	M 12	1



**06**  
**Steel split pins**  
DIN 94 / ISO 1234

galvanised

► **Item no. 6470**  
(Art. no. x cotter pin thickness x cotter pin length)



**07**  
**Adapter sleeves**  
DIN 1481, blank

Item No.	O	length	Strength	PU
6476-2-20	2 mm	20 mm	0,4 mm	100
6476-2-30	2 mm	30 mm	0,4 mm	100
6476-3-20	3 mm	20 mm	0,6 mm	100
6476-3-40	3 mm	40 mm	0,6 mm	100
6476-4-40	4 mm	40 mm	0,8 mm	100
6476-4-60	4 mm	60 mm	0,8 mm	100
6476-5-30	5 mm	30 mm	1,0 mm	50
6476-5-40	5 mm	40 mm	1,0 mm	50
6476-5-60	5 mm	60 mm	1,0 mm	50
6476-6-40	6 mm	40 mm	1,2 mm	50
6476-6-50	6 mm	50 mm	1,2 mm	50
6476-6-60	6 mm	60 mm	1,2 mm	50
6476-8-40	8 mm	40 mm	1,5 mm	25
6476-8-50	8 mm	50 mm	1,5 mm	25
6476-8-60	8 mm	60 mm	1,5 mm	25
6476-8-80	8 mm	80 mm	1,5 mm	20
6476-10-60	10 mm	60 mm	2,0 mm	20







01

**Assortment of pan head tapping screws**

with Phillips cross recess (form H), DIN 7981 / ISO 7046 - galvanized, strength class 4.8

► **Item no. 1957-115**► **Contents: 1.600**

- 100 x 3.5 x 13 (Item No. 6115-35-13)
- 100 x 3.5 x 16 (Item No. 6115-35-16)
- 100 x 3.5 x 19 (Item No. 6115-35-19)
- 100 x 3.5 x 9.5 (Item No. 6115-35-95)
- 100 x 3.9 x 19 (Item No. 6115-39-19)
- 100 x 4.2 x 13 (Item No. 6115-42-13)
- 100 x 4.2 x 16 (Item No. 6115-42-16)
- 100 x 4.2 x 19 (Item No. 6115-42-19)
- 100 x 4.2 x 22 (Item No. 6115-42-22)
- 100 x 4.2 x 25 (Item No. 6115-42-25)
- 100 x 4.2 x 9.5 (Item No. 6115-42-95)
- 100 x 4.8 x 13 (Item No. 6115-48-13)
- 100 x 4.8 x 16 (Item No. 6115-48-16)
- 100 x 4.8 x 19 (Item No. 6115-48-19)
- 100 x 4.8 x 22 (Item No. 6115-48-22)
- 100 x 4.8 x 25 (Item No. 6115-48-25)



02

**Pan head tapping screw assortment with cross recess**

with Phillips cross recess (form H), DIN 7981 / ISO 7049,? black galvanized

► **Item no. 1957-134**► **Contents: 1,650 pieces**

- 100 x 3.5X13 (Item No. 6134-35-13)
- 100 x 3.5X16 (Item No. 6134-35-16)
- 100 x 3.5X19 (Item No. 6134-35-19)
- 100 x 3.5X9.5 (Item No. 6134-35-95)
- 100 x 3,9X13 (Item No. 6134-39-13)
- 100 x 3,9X16 (Item No. 6134-39-16)
- 100 x 3,9X19 (Item No. 6134-39-19)
- 100 x 4,2X13 (Item No. 6134-42-13)
- 100 x 4.2X16 (Item No. 6134-42-16)
- 100 x 4.2X19 (Item No. 6134-42-19)
- 100 x 4.2X25 (Item No. 6134-42-25)
- 100 x 4.2X9.5 (Item No. 6134-42-95)
- 100 x 4.8X13 (Item No. 6134-48-13)
- 100 x 4.8X16 (Item No. 6134-48-16)
- 100 x 4.8X19 (Item No. 6134-48-19)
- 100 x 5.5X16 (Item No. 6134-55-16)
- 50 x 5.5X19 (Item No. 6134-55-19)
- 50 x 5.5X25 (Item No. 6134-55-25)





01

**Assortment of pan head tapping screws**

with Phillips cross recess (form H) with collar and drill point,? DIN 7981 / ISO 7049, galvanized black

## ▶ Item no. 1957-135-0

## ▶ Contents: 1,103 parts:

- 200 x 4.2 X 13 (Item No. 6135-042-13)
- 200 x 4.2 X 16 (Item No. 6135-042-16)
- 200 x 4.2 X 19 (Item No. 6135-042-19)
- 100 x 4.2 X 25 (Item No. 6135-042-25)
- 200 x 4.8 X 16 (Item No. 6135-048-16)
- 100 x 4.8 X 22 (Item No. 6135-048-22)
- 100 x 4.8 X 35 (Item No. 6135-048-35)
- 3 x HAZET Phillips screwdriver bits? 2215-PH2A (item no. 6135-221-5)



02

**Assortment of sheet metal screws**

with Phillips cross recess (form H), collar and point, similar to DIN 7981, galvanized black

## ▶ Item no. 1957-134-0

## ▶ Contents: 1,400 parts

- 100 x 3.9 X 9.5 (Item No. 6134-039-95)
- 100 x 3.9 X 13 (Item No. 6134-039-13)
- 100 x 3.9 X 16 (Item No. 6134-039-16)
- 100 x 3.9 X 19 (Item No. 6134-039-19)
- 50 x 3.9 X 22 (Item No. 6134-039-22)
- 50 x 3.9 X 25 (Item No. 6134-039-25)
- 100 x 4.2 X 9.5 (Item No. 6134-042-95)
- 100 x 4.2 X 13 (Item No. 6134-042-13)
- 100 x 4.2 X 16 (Item No. 6134-042-16)
- 100 x 4.2 X 19 (Item No. 6134-042-19)
- 50 x 4.2 X 22 (Item No. 6134-039-13)
- 50 x 4.2 X 25 (Item No. 6134-042-22)
- 100 x 4.8 X 9.5 (Item No. 6134-048-95)
- 100 x 4.8 X 13 (Item No. 6134-048-13)
- 50 x 4.8 X 16 (Item No. 6134-039-13)
- 50 x 4.8 X 19 (Item No. 6134-048-16)
- 50 x 4.8 X 22 (Item No. 6134-048-22)
- 50 x 4.8 X 25 (Item No. 6134-048-25)





01

**Assortment of hexagon tapping screws**

with washers and speed nuts

## ▶ Item no. 1957-129-1

## ▶ Contents: 800 parts

- 200 x speed nuts 4.8 (Item No. 5500-113-65)
- 150 x speed nuts 6.5 (Item No. 5500-113-69)
- 100 x speed nuts 5.6 (Item No. 5500-115-77)
- 100 x hexagon sheet metal screws 4.8 x 16 (Item No. 6129-48-16)
- 50 x hexagon tapping screws 4.8 x 19 (Item No. 6129-48-19)
- 50 x hexagon tapping screws 5.5 x 16 (Item No. 6129-55-16)
- 50 x hexagon tapping screws 6.5 x 16 (Item No. 6129-65-16)
- 100 x hexagon tapping screws 6.5 x 20 (Item No. 6129-65-20)



02

**Range of fender washers**

Tolerance according to DIN 522 C, galvanized

## ▶ Item no. 1957-411

## ▶ Contents: 1,200 parts

- 100 x 4.3 X 12 X 1.25 (Item No. 6411-4-12)
- 100 x 4.3 X 20 X 1.25 (Item No. 6411-4-20)
- 100 x 5.3 X 15 X 1.25 (Item No. 6411-5-15)
- 100 x 5.3 X 20 X 1.25 (Item No. 6411-5-20)
- 100 x 6.4 X 15 X 1.5 (Item No. 6411-6-15)
- 100 x 6.4 X 18 X 1.5 (Item No. 6411-6-18)
- 100 x 6.4 X 20 X 1.25 (Item No. 6411-6-20)
- 50 x 6.4 X 30 X 1.25 (Item No. 6411-6-30)
- 100 x 6.5 X 25 X 1.25 (Item No. 6411-6-25)
- 50 x 6.5 X 40 X 1.5 (Item No. 6411-6-40)
- 100 x 8.4 X 25 X 1.5 (Item No. 6411-8-25)
- 50 x 8.4 X 30 X 1.5 (Item No. 6411-8-30)
- 100 x 8.5 X 20 X 1.25 (Item No. 6411-8-20)
- 50 x 10.5 X 30 X 1.5 (item no. 6411-10-30)
- 30 x 10.5 X 40 X 2 (Item No. 6411-10-40)
- 50 x 13.0 X 32 X 1.5 (Item No. 6411-12-30)





01

**Steel split pin range**

DIN 94 / ISO 1234, galvanized

- ▶ Item no. 1957-470
- ▶ Contents: 1,100 parts:
  - 100 x 1.6 x 32 (Item No. 6470-16-32)
  - 100 x 2 x 22 (Item No. 6470-2-22)
  - 100 x 2 x 32 (Item No. 6470-2-32)
  - 100 x 2 x 40 (Item No. 6470-2-40)
  - 100 x 3.2 x 20 (Item No. 6470-32-20)
  - 100 x 3.2 x 32 (Item No. 6470-32-32)
  - 100 x 3.2 x 40 (Item No. 6470-32-40)
  - 100 x 4 x 32 (Item No. 6470-4-32)
  - 100 x 4 x 40 (Item No. 6470-4-40)
  - 100 x 4 x 50 (Item No. 6470-4-50)
  - 50 x 5 x 40 (Item No. 6470-5-40)
  - 50 x 5 x 50 (Item No. 6470-5-50)

02

**Assortment tower unequipped**  
stackable, for wall mounting, lockable

- ▶ Item no. 1958-100
- ▶ Technical specifications
  - stackable
  - for wall mounting
  - lockable
  - 5 times
  - HxWxD = 360mm x 390mm x 256mm



03

**Assortment box**  
made of plastic

- ▶ Item no. 1958-001
- ▶ Technical specifications
  - Width: 320 mm
  - Depth: 240 mm
  - Height: 49mm



04

**contents**  
without text

- ▶ Item no. 1957-001-0
- ▶ Technical specifications
  - self-adhesive
  - for individual labelling





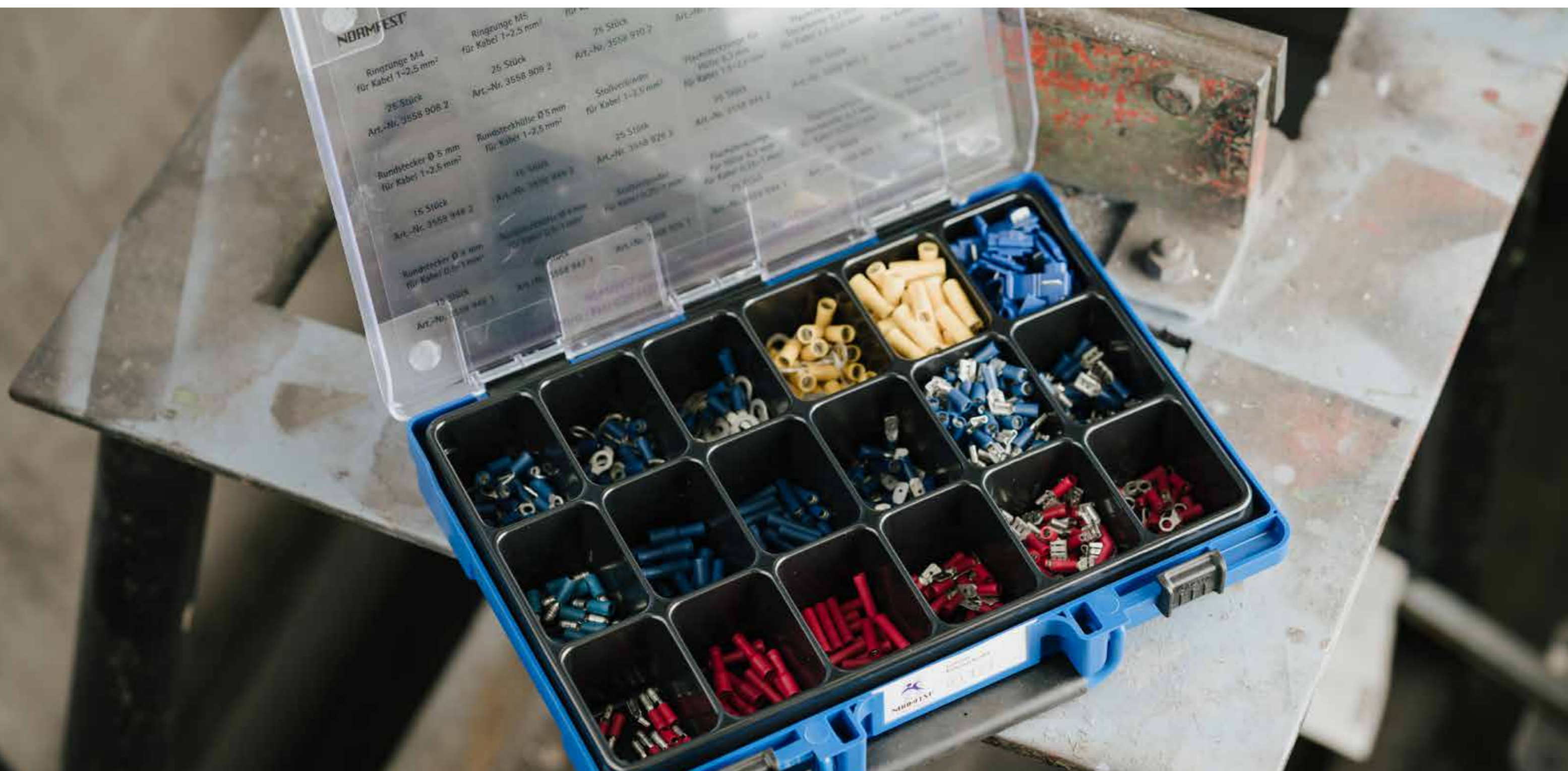





01

**Copper sealing rings assortment DIN 7603A**

1,190-part

► Item no. 1957-460

► Content:

- Contents: 1,190 parts

- 100 x copper sealing rings 6 x 10 x 1 (item no. 6460-6-10)
- 100 x copper sealing rings 8 x 12 x 1 (item no.6460-8-12)
- 100 x copper sealing rings 8 x 14 x 1 (item no.6460-8-14)
- 100 x copper sealing rings 10 x 14 x 1 (item no.6460-10-14)
- 100 x copper sealing rings 10 x 16 x 1 (item no. 6460-10-16)
- 100 x copper sealing rings 12 x 16 x 1.5 (item no.6460-12-16)
- 100 x copper sealing rings 12 x 18 x 1.5 (item no.6460-12-18)
- 50 x copper sealing rings 14 x 18 x 1.5 (item no.6460-14-18)
- 50 x copper sealing rings 14 x 20 x 1.5 (item no. 6460-14-20)
- 50 x copper sealing rings 14 x 22 x 1.5 (item no.6460-14-22)
- 50 x copper sealing rings 16 x 22 x 1.5 (item no.6460-16-22)
- 50 x copper sealing rings 18 x 24 x 1.5 (item no.6460-18-24)
- 50 x copper sealing rings 20 x 26 x 1.5 (item no.6460-20-26)
- 50 x copper sealing rings 22 x 27 x 1.5 (item no.6460-22-27)
- 50 x copper sealing rings 22 x 29 x 1.5 (item no.6460-22-29)
- 30 x copper sealing rings 24 x 30 x 2 (item no. 6460-24-30)
- 30 x copper sealing rings 26 x 32 x 2 (item no.6460-26-32)
- 30 x copper sealing rings 28 x 34 x 2 (item no.6460-28-34)



02

**Sealing rings for oil drain plug assortment**

1,000-piece

► Item no. 1957-462

► Content:

- Contents: 1,000 parts

- 100 x copper sealing ring form A 12 x 18 x 1.5 (item no.6460-12-18)
- 100 x copper sealing ring form A 14 x 20 x 1.5 (item no.6460-14-20)
- 100 x copper sealing ring form C 14 x 21 x 2 (item no. 6462-14-21)
- 100 x copper sealing ring form C 16 x 22 x 2 (item no. 6462-16-22)
- 100 x copper sealing ring form C 18 x 24 x 2 (item no. 6462-18-24)
- 100 x aluminum sealing ring form A 12 x 17 x 1.5 (item no. 6463-12-18)
- 50 x Toyota sealing ring NF231 12 x 24 x 2 (item no. 6464-012-242)
- 50 x Nissan folding rings 11 x 17 x 3 (item no. 6464-11-17)
- 50 x Ford seal NBR 70 12.8 x 22.5 x 3 (item no. 6464-128-225)
- 100 x plastic sealing ring PA6 14.5 x 22 x 2 (item no. 6464-14-22)
- 50 x Ford sealing ring 16.7 x 24 x 2 large lips (item no. 6464-16-24)
- 100 x sealing ring Opel NBR 70 18 x 22 x 2 (item no. 6464-18-2)





01

**O-rings assortment Perbunan**

1,050-part

▶ Item no. 1957-468-1

## ▶ Content:

- Contents: 1,050 parts
- 100 x O-rings made of Perbunan 3.00 x 2.00 (Item No. 6468-003-20)
- 100 x O-rings made of Perbunan 4.00 x 2.00 (Item No. 6468-004-20)
- 100 x O-rings made of Perbunan 5.00 x 2.00 (Item No. 6468-005-20)
- 100 x O-rings made of Perbunan 6.00 x 2.00 (Item No. 6468-006-20)
- 100 x O-rings made of Perbunan 7.00 x 2.00 (Item No. 6468-007-20)
- 100 x O-rings made of Perbunan 8.00 x 2.00 (Item No. 6468-008-20)
- 50 x O-rings made of Perbunan 10.00 x 2.00 (Item No. 6468-010-20)
- 50 x O-rings made of Perbunan 10.00 x 2.50 (item no. 6468-010-25)
- 50 x O-rings made of Perbunan 12.00 x 2.00 (Item No. 6468-012-20)
- 50 x O-rings made of Perbunan 12.00 x 2.50 (Item No. 6468-012-25)
- 50 x O-rings made of Perbunan 14.00 x 2.50 (item no. 6468-014-25)
- 50 x O-rings made of Perbunan 15.00 x 2.50 (item no. 6468-015-25)
- 25 x O-rings made of Perbunan 17.00 x 2.50 (Item No. 6468-017-25)
- 25 x O-rings made of Perbunan 18.00 x 3.00 (Item No. 6468-018-30)
- 25 x O-rings made of Perbunan 19.00 x 2.50 (Item No. 6468-019-25)
- 25 x O-rings made of Perbunan 20.00 x 3.00 (Item No. 6468-020-30)
- 25 x O-rings made of Perbunan 22.00 x 3.00 (Item No. 6468-022-30)
- 25 x O-rings made of Perbunan 24.00 x 3.00 (Item No. 6468-024-30)



02

**Plastic hose connector assortment**

160 pieces

▶ Item no. 1957-896

## ▶ Content:

- 10 x straight hose connector 3mm (Art.-No. 5896-103)
- 10 x straight tube connector 4mm (Art.-No. 5896-104)
- 10 x straight tube connectors 5mm (Art.-No. 5896-105)
- 10 x straight tube connectors 6mm (Art.-No. 5896-106)
- 10 x T-hose connector 3mm (Art.-No. 5896-203)
- 10 x T-tube connector 4mm (Art.-No. 5896-204)
- 10 x T-tube connector 5mm (Art.-No. 5896-205)
- 10 x T-hose connector 6mm (Art.-No. 5896-206)
- 10 x angled hose connectors 3mm (Art.-No. 5896-303)
- 10 x angled hose connectors 4mm (Art.-No. 5896-304)
- 10 x angled hose connectors 5mm (Art.-No. 5896-305)
- 10 x angled hose connectors 6mm (Art.-No. 5896-306)
- 10 x Y-hose connector 3mm (Art.-No. 5896-403)
- 10 x Y-hose connector 4mm (Art.-No. 5896-404)
- 10 x Y-tube connector 5mm (Art.-No. 5896-405)
- 10 x Y-hose connector 6mm (art.-no. 5896-406)





01

**Night Line twist drill assortment**

Basic range

► **Item no. 1957-626**► **Content:**

- Characteristics:
- Profile ground
- ground from a solid blank
- HSS drill
- Suitable for hand drills
- Point angle 118 °
- relatively good penetration behavior
- reduced cross cutting edge
- high stability
- quiet running behavior
- Contents: 120 parts:
- 10 x 1.0mm (Item No. 4626-10)

- 10 x 1.5mm (Item No. 4626-15)
- 10 x 2.0mm (Item No. 4626-20)
- 10 x 2.5mm (Item No. 4626-25)
- 5 x 3.0mm (Item No. 4626-30)
- 5 x 3.5mm (Item No. 4626-35)
- 5 x 4.0mm (Item No. 4626-40)
- 5 x 4.5mm (Item No. 4626-45)
- 5 x 5.0mm (Item No. 4626-50)
- 5 x 5.5mm (Item No. 4626-55)
- 5 x 6.0mm (Item No. 4626-60)
- 5 x 6.5mm (Item No. 4626-65)
- 5 x 7.0mm (Item No. 4626-70)
- 5 x 7.5mm (Item No. 4626-75)
- 5 x 8.0mm (Item No. 4626-80)
- 5 x 8.5mm (Item No. 4626-85)
- 5 x 9.0mm (Item No. 4626-90)
- 5 x 9.5mm (Item No. 4626-95)
- 5 x 10.0mm (Item No. 4626-100)
- 5 x 10.5mm (Item No. 4626-105)
- 1 x assortment box
- 1 x inlet 20-fold



02

**Stratus twist drill range**

profile ground and right hand cutting, DIN 384

► **Item no. 1957-627-1**► **Content:**

- Special grinding:
- quiet concentricity
- no center punching
- Drilling possible on curved surfaces
- 
- Characteristics:
- HSS-O drill
- All-round drill for almost all materials
- Ground from a solid blank
- highest breaking strength for all diameters
- low chip curvature
- 
- Point angle:
- up to 50% faster than conventional twist drills
- low energy consumption
- particularly suitable for cordless drills
- 
- Content:
- 5 x 1.0 mm (Item No. 4627-10)

- 5 x 1.5 mm (Item No. 4627-15)
- 5 x 2.0 mm (Item No. 4627-20)
- 5 x 2.5 mm (Item No. 4627-25)
- 3 x 3.0 mm (Item No. 4627-30)
- 3 x 3.5 mm (Item No. 4627-35)
- 3 x 4.0 mm (Item No. 4627-40)
- 3 x 4.5 mm (Item No. 4627-45)
- 3 x 5.0 mm (Item No. 4627-50)
- 3 x 5.5 mm (Item No. 4627-55)
- 3 x 6.0 mm (Item No. 4627-60)
- 3 x 6.5 mm (Item No. 4627-65)
- 3 x 7.0 mm (Item No. 4627-70)
- 3 x 7.5 mm (Item No. 4627-75)
- 3 x 8.0 mm (Item No. 4627-80)
- 3 x 8.5 mm (Item No. 4627-85)
- 3 x 9.0 mm (Item No. 4627-90)
- 3 x 9.5 mm (Item No. 4627-95)
- 3 x 10.0 mm (Item No. 4627-100)
- 3 x 10.5 mm (Item No. 4627-105)
- 1 x assortment box
- 1 x inlet 20-fold





01

**Clips**

500-piece

► Item no. 1957-550

► Contents: 500 parts

- 50 x 5501-103-015 plastic expanding rivet black for 8mm hole
- 50 x 5500-940-5 Christmas tree clip Ford black plastic
- 50 x 5500-127-10 plastic expanding rivets black Opel / Audi / VW
- 50 x 5500-879-32 plastic expanding rivets, black
- 100 x 5500-500-08 upholstery clip
- 50 x 5500-201-404 plastic expanding rivets, black
- 100 x 5500-000-000 retaining clips V.A.G / FO
- 50 x 5500-130-11 plastic expanding rivets Opel / Audi / VW



02

**Clips**

160 pieces

► Item no. 1957-551

► Contents: 160 clips and brackets

- 10 x item no. 5500-130-11 PLASTIC SPREAD RIVET OPEL / AUDI / VW
- 10 x item no. 5500-201-404 PLASTIC SPREAD RIVET, BLACK
- 10 x item no. 5501-105-064 PLASTIC SPREAD RIVET FOR BUMPER
- 10 x item no. 5500-113-69 METAL NUTS ST 6.5MM VZ
- 10 x item no. 5500-523-14 PLASTIC SPREAD RIVET, BLACK
- 10 x item no. 5500-879-32 SPREADING NUT, BLACK
- 10 x item no. 5501-132-003 PLASTIC SPREAD RIVET, BLACK
- 10 x item no. 5500-113-65 TIN NUT ST 4.8MM VZ MATTE
- 10 x item no. 5500-115-77 TIN NUT ST 5,6MM VZ MATT MATT
- 10 x item no. 5500-940-5 FIR TREE CLIP FORD PA BLACK
- 10 x item no. 5500-127-10 PLASTIC SPREAD RIVET, BLACK
- 10 x item no. 5500-897-33 SPREADING NUT, BLACK
- 10 x item no. 5501-103-017 PLASTIC SPREAD RIVET WITH CAP SCHWA
- 10 x item no. 5501-529-80 BLIND RIVET, PLASTIC, BLACK
- 10 x item no. 5501-105-065 PLASTIC SPREAD RIVET, BLACK
- 10 x item no. 5500-939-5 PL PLUG, BLACK OPEL
- 1 x item no. 1958-001 ASSORTMENT BOX, PLASTIC 210 X 302
- 1 x item no. 1958-211 FOAM CUT-OUT FOR ASSORTMENTS
- 1 x item no. 1958-001-16 INLET FOR ASSORTMENT BOX KST16 COMPARTMENT





01

**Universal O-ring range**

small diameter

► Item no. 1957-500-1

► Technical specifications

- common O-rings for car air conditioning

- Contents: 360 parts

- 20 x 4.47 x 1.78 (Item No. 5000-003)
- 20 x 6.02 x 2.62 (Item No. 5000-032)
- 20 x 6.07 x 1.78 (Item No. 5000-007)
- 20 x 6.70 x 1.70 (Item No. 5000-067)
- 20 x 6.95 x 2.20 (Item No. 5000-070)
- 20 x 7.50 x 2.50 (Item No. 5000-068)
- 20 x 7.65 x 1.63 (Item No. 5000-012)
- 20 x 7.65 x 1.78 (Item No. 5000-050)
- 20 x 7.00 x 1.50 (Item No. 5000-069)
- 20 x 8.00 x 1.80 (Item No. 5000-071)
- 20 x 8.00 x 2.00 (Item No. 5000-004)
- 20 x 8.80 x 1.90 (Item No. 5000-072)
- 20 x 9.25 x 1.78 (Item No. 5000-016)
- 20 x 9.25 x 2.39 (Item No. 5000-005)
- 20 x 9.50 x 2.50 (Item No. 5000-060)
- 20 x 10.12 x 1.85 (Item No. 5000-010)
- 20 x 10.00 x 2.00 (Item No. 5000-073)
- 20 x 10.00 x 2.50 (Item No. 5000-008)



02

**Universal O-ring range**

large diameter

► Item no. 1957-500-2

► Technical specifications

- most common O-rings for truck air conditioning

- Contents: 360 parts

- 20 x 10.77 X 2.62 (Item No. 5000-034)
- 20 x 10.80 X 2.40 (Item No. 5000-009)
- 20 x 10.80 X 2.40 (Item No. 5000-061)
- 20 x 10.82 X 1.78 (Item No. 5000-017)
- 20 x 11.50 X 2.50 (Item No. 5000-062)
- 20 x 12.01 X 1.88 (Item No. 5000-047)
- 20 x 12.37 X 2.62 (Item No. 5000-035)
- 20 x 13.40 X 1.78 (Item No. 5000-063)
- 20 x 13.80 X 2.40 (Item No. 5000-064)
- 20 x 13.94 X 2.62 (Item No. 5000-036)
- 20 x 14.00 X 1.78 (Item No. 5000-023)
- 20 x 14.25 X 2.40 (Item No. 5000-065)
- 20 x 14.30 X 2.30 (Item No. 5000-021)
- 20 x 14.50 X 2.50 (Item No. 5000-066)
- 20 x 15.47 X 3.53 (Item No. 5000-043)
- 20 x 15.68 X 1.93 (Item No. 5000-026)
- 20 x 17.17 X 1.78 (Item No. 5000-028)
- 20 x 17.00 X 2.00 (Item No. 5000-029)





01

### Cable connector range waterproof

► Item no. 1957-555

► Contents: 400 parts

- 50 x heat shrink connectors red 0.5-1.5 (item no. 3555-516-1)
- 50 x heat shrink connector blue 1.5-2.5 (item no. 3555-516-2)
- 25 x heat shrink connector yellow 4.0-6.0 (item no. 3555-516-4)
- 25 x ring tongue M6 red with shrink tubing (item no. 3555-903-1)
- 25 x ring tongue M8 red with shrink tube (item no. 3555-904-1)
- 25 x ring tongue M5 blue with shrink tubing (item no. 3555-909-2)
- 25 x ring tongue M8 blue with shrink tube (item no. 3555-911-2)
- 50 x butt connector solderable red 0.5-1.5 (Art.-No. 3555-923-1)
- 50 x butt connectors solderable blue 1.5-2.5 (item no. 3555-923-2)
- 25 x butt connectors solderable yellow 3.0-6.0 (item no. 3555-923-3)
- 25 x blue flat tabs with shrink tubing (item no. 3555-945-2)
- 25 x flat receptacles blue with shrink tubing (item no. 3555-905-2)



02

### Cable connector range isolated

► Item no. 1957-558-1

► Contents: 530 parts

- 20 x cable quick connector blue (item no. 3555-564)
- 25 x ring tongue M4 red (Art.-No. 3558-901-1)
- 50 x red flat receptacles (Item No. 3558-905-1)
- 100 x flat receptacle blue (Item No. 3558-905-2)
- 50 x yellow flat receptacles (item no. 3558-905-4)
- 25 x ring tongues M4 blue (item no. 3558-908-2)
- 25 x ring tongue M5 blue (item no. 3558-909-2)
- 25 x ring tongue M6 blue (item no. 3558-910-2)
- 25 x ring tongue M6 yellow (Art.-No. 3558-916-4)
- 25 x butt connector red (item no. 3558-925-1)
- 25 x butt connectors blue (item no. 3558-926-2)
- 25 x double flat plugs blue (item no. 3558-943-2)
- 25 x flat tabs 6.3mm red (Item No. 3558-944-1)
- 25 x flat tabs 6.3mm blue (item no. 3558-945-2)
- 15 x round plugs red (Item No. 3558-946-1)
- 15 x round socket red (Item No. 3558-947-1)
- 15 x round plugs blue (item no. 3558-948-2)
- 15 x round socket blue (item no. 3558-949-2)





01

**Assortment of plug fuses**  
including tester and gripper set

► Item no. 1957-730-1

► Contents: 161 parts

- 10 x 3A (Item no. 3731-003)
- 10 x 5A (Item No. 3731-005)
- 10 x 7.5A (Item No. 3731-007-5)
- 10 x 10A (Item No. 3731-010)
- 10 x 15A (Item No. 3731-015)
- 10 x 20A (Item No. 3731-020)
- 10 x 25A (Item No. 3731-025)
- 10 x 30A (Item No. 3731-030)
- 10 x 3A MINI (Item No. 3731-103)
- 10 x 5A MINI (Item No. 3731-105)
- 10 x 7.5A MINI (Item No. 3731-107-5)
- 10 x 10A MINI (Item No. 3731-110)
- 10 x 15A MINI (Item No. 3731-115)
- 10 x 20A MINI (Item No. 3731-120)
- 10 x 25A MINI (Item No. 3731-125)
- 10 x 30A MINI (Item No. 3731-130)
- 1 x tester and gripper set (item no. 3731-150)



02

**Assortment of plug fuses**  
Mini and low profile fuses

► Item no. 1957-730-2

► Contents: 400 fuses

- 25 x 3A MINI plug-in fuse (item no. 3731-103)
- 25 x 5A MINI plug-in fuse (item no. 3731-105)
- 25 x plug-in fuse 7.5A MINI (item no. 3731-107-5)
- 25 x plug-in fuse 10A MINI (item no. 3731-110)
- 25 x 15A MINI fuse (item no. 3731-115)
- 25 x plug-in fuse 20A MINI (item no. 3731-120)
- 25 x plug-in fuse 25A MINI (item no. 3731-125)
- 25 x 30A MINI fuse (item no. 3731-130)
- 25 x 3A / LOW-PROFILE plug-in fuse (item no. 3731-303)
- 25 x 5A / LOW-PROFILE plug-in fuse (item no. 3731-305)
- 25 x plug-in fuse 7.5A / LOW-PROFILE (item no. 3731-307-5)
- 25 x plug-in fuse 10A / LOW-PROFILE (item no. 3731-310)
- 25 x plug-in fuse 15A / LOW-PROFILE (item no. 3731-315)
- 25 x plug-in fuse 20A / LOW-PROFILE (item no. 3731-320)
- 25 x plug-in fuse 25A / LOW-PROFILE (item no. 3731-325)
- 25 x 30A / LOW-PROFILE plug-in fuse (item no. 3731-330)





01

**Waterproof plug-in housing range**

waterproof, vibration-proof

► Item no. 1957-560

## ► Content:

- 4 x lock housing with 2-way seal (item no. 3558-82)
- 4 x lock housing with 3-way seal (item no. 3558-83)
- 4 x lock housing with 4-way seal (item no. 3558-84)
- 4 x lock housing with 5-way seal (item no. 3558-85)
- 4 x lock housing with 6-way seal (item no. 3558-86)
- 4 x housing 2-way (item no. 3558-82-1)
- 4 x 3-way housing (item no. 3558-83-1)
- 4 x receiving housing 4-way (item no. 3558-84-1)
- 4 x receiving housing 5-way (item no. 3558-85-1)
- 4 x 6-way housing (item no. 3558-86-1)
- 100 x flat receptacles 0.75 - 1.5 (item no. 3558-87-2)
- 100 x flat receptacles 0.75 - 1.5 (item no. 3558-87-21)
- 100 x sealing plugs yellow 0.75 - 1.5 (item no. 3558-88-2)
- 100 x sealing plugs red 1.5 - 2.5 (item no. 3558-88-3)



02

**Shrink tubing assortment**

black

► Item no. 1957-570

## ► Content:

- Length per piece: 10 cm
- Shrink rate 2: 1
- Contents: 125 parts
- 25 x 2.4mm / 1.2mm (Item No. 3771-200-24)
- 25 x 3.2mm / 1.6mm (Item No. 3771-200-32)
- 25 x 4.8mm / 2.4mm (Item No. 3771-200-48)
- 10 x 6.4mm / 3.2mm (Item No. 3771-200-64)
- 10 x 9.5mm / 4.7mm (Item No. 3771-200-95)
- 10 x 12.7mm / 6.4mm (Item No. 3771-200-127)
- 10 x 19.0mm / 9.5mm (Item No. 3771-200-190)
- 10 x 25.4mm / 12.7mm (Item No. 3771-200-254)



01

**Straight connector assortment**

Brass, plastic

► Item no. 1957-100-1

► Contents: 40 parts

- 5 x plastic straight connector 4mm (item no. 1002-06-04)
- 5 x plastic straight connector 5mm (item no. 1002-06-05)
- 5 x plastic straight connector 6mm (item no. 1002-06-06)
- 5 x plastic straight connectors 8mm (item no. 1002-06-08)
- 5 x brass straight connector 10mm (Item No. 1002-16-010)
- 5 x brass straight connectors 12mm (item no. 1002-16-012)
- 5 x brass straight connector 6mm (item no. 1002-16-06)
- 5 x brass straight connectors 8mm (item no. 1002-16-08)



02

**Adapter sleeve assortment**

DIN 1481, blank

► Item no. 1957-476

► Contents: 985 parts

- 100 x 2 X 20 (Item No. 6476-2-20)
- 100 x 2 X 30 (Item No. 6476-2-30)
- 100 x 3 X 20 (Item No. 6476-3-20)
- 100 x 3 X 40 (Item No. 6476-3-40)
- 100 x 4 X 40 (Item No. 6476-4-40)
- 100 x 4 X 60 (Item No. 6476-4-60)
- 50 x 5 X 30 (Item No. 6476-5-30)
- 50 x 5 X 40 (Item No. 6476-5-40)
- 50 x 5 X 60 (Item No. 6476-5-60)
- 50 x 6 X 40 (Item No. 6476-6-40)
- 50 x 6 X 50 (Item No. 6476-6-50)
- 50 x 6 X 60 (Item No. 6476-6-60)
- 25 x 8 X 40 (Item No. 6476-8-40)
- 25 x 8 X 50 (Item No. 6476-8-50)
- 25 x 8 X 60 (Item No. 6476-8-60)
- 10 x 10 X 60 (Item No. 6476-10-60)





01

**Assortment of fittings**

Contents: 123 parts

► Item no. 1957-54-016

## ► Content:

- 10 x cutting ring 6 (Item No. 1002-54-062)
- 10 x cutting ring 8 (Item No. 1002-54-082)
- 8 x cutting ring 10 (item no. 1002-54-102)
- 8 x cutting ring 12 (Item No. 1002-54-122)
- 5 x cutting ring 15 (Item No. 1002-54-152)
- 10 x union nut 6 (item no. 1002-54-063)
- 10 x union nut 8 (item no. 1002-54-083)
- 8 x union nut 10 (item no. 1002-54-103)
- 8 x union nut 12 (item no. 1002-54-123)
- 5 x union nut 15 (item no. 1002-54-153)
- 10 x support sleeves 6 x 1 (item no. 1002-54-061)
- 10 x support sleeves 8 x 1 (item no. 1002-54-081)
- 8 x support sleeves 10 x 1 (item no. 1002-54-101)
- 8 x support sleeves 12 x 1 (item no. 1002-54-121)
- 5 x support sleeve 15 x 1.5 (item no. 1002-54-151)



02

**Assortment of pan head tapping screws**

with Phillips cross recess (form H), DIN 7981 / ISO 7046 - galvanized, strength class 4.8

► Item no. 1957-115

## ► Contents: 1.600

- 100 x 3.5 x 13 (Item No. 6115-35-13)
- 100 x 3.5 x 16 (Item No. 6115-35-16)
- 100 x 3.5 x 19 (Item No. 6115-35-19)
- 100 x 3.5 x 9.5 (Item No. 6115-35-95)
- 100 x 3.9 x 19 (Item No. 6115-39-19)
- 100 x 4.2 x 13 (Item No. 6115-42-13)
- 100 x 4.2 x 16 (Item No. 6115-42-16)
- 100 x 4.2 x 19 (Item No. 6115-42-19)
- 100 x 4.2 x 22 (Item No. 6115-42-22)
- 100 x 4.2 x 25 (Item No. 6115-42-25)
- 100 x 4.2 x 9.5 (Item No. 6115-42-95)
- 100 x 4.8 x 13 (Item No. 6115-48-13)
- 100 x 4.8 x 16 (Item No. 6115-48-16)
- 100 x 4.8 x 19 (Item No. 6115-48-19)
- 100 x 4.8 x 22 (Item No. 6115-48-22)
- 100 x 4.8 x 25 (Item No. 6115-48-25)





01

**Assortment of hexagon tapping screws**

with washers and speed nuts

► Item no. 1957-129-1

► Contents: 800 parts

- 200 x speed nuts 4.8 (Item No. 5500-113-65)
- 150 x speed nuts 6.5 (Item No. 5500-113-69)
- 100 x speed nuts 5.6 (Item No. 5500-115-77)
- 100 x hexagon sheet metal screws 4.8 x 16 (Item No. 6129-48-16)
- 50 x hexagon tapping screws 4.8 x 19 (Item No. 6129-48-19)
- 50 x hexagon tapping screws 5.5 x 16 (Item No. 6129-55-16)
- 50 x hexagon tapping screws 6.5 x 16 (Item No. 6129-65-16)
- 100 x hexagon tapping screws 6.5 x 20 (Item No. 6129-65-20)



02

**Pan head tapping screw assortment with cross recess**

with Phillips cross recess (form H), DIN 7981 / ISO 7049,? black galvanized

► Item no. 1957-134

► Contents: 1,650 pieces

- 100 x 3.5X13 (Item No. 6134-35-13)
- 100 x 3.5X16 (Item No. 6134-35-16)
- 100 x 3.5X19 (Item No. 6134-35-19)
- 100 x 3.5X9.5 (Item No. 6134-35-95)
- 100 x 3,9X13 (Item No. 6134-39-13)
- 100 x 3,9X16 (Item No. 6134-39-16)
- 100 x 3,9X19 (Item No. 6134-39-19)
- 100 x 4,2X13 (Item No. 6134-42-13)
- 100 x 4.2X16 (Item No. 6134-42-16)
- 100 x 4.2X19 (Item No. 6134-42-19)
- 100 x 4.2X25 (Item No. 6134-42-25)
- 100 x 4.2X9.5 (Item No. 6134-42-95)
- 100 x 4.8X13 (Item No. 6134-48-13)
- 100 x 4.8X16 (Item No. 6134-48-16)
- 100 x 4.8X19 (Item No. 6134-48-19)
- 100 x 5.5X16 (Item No. 6134-55-16)
- 50 x 5.5X19 (Item No. 6134-55-19)
- 50 x 5.5X25 (Item No. 6134-55-25)





01

**Assortment of sheet metal screws**

with Phillips cross recess (form H), collar and point, similar to DIN 7981, galvanized black

► Item no. 1957-134-0

► Contents: 1,400 parts

- 100 x 3.9 X 9.5 (Item No. 6134-039-95)
- 100 x 3.9 X 13 (Item No. 6134-039-13)
- 100 x 3.9 X 16 (Item No. 6134-039-16)
- 100 x 3.9 X 19 (Item No. 6134-039-19)
- 50 x 3.9 X 22 (Item No. 6134-039-22)
- 50 x 3.9 X 25 (Item No. 6134-039-25)
- 100 x 4.2 X 9.5 (Item No. 6134-042-95)
- 100 x 4.2 X 13 (Item No. 6134-042-13)
- 100 x 4.2 X 16 (Item No. 6134-042-16)
- 100 x 4.2 X 19 (Item No. 6134-042-19)
- 50 x 4.2 X 22 (Item No. 6134-039-13)
- 50 x 4.2 X 25 (Item No. 6134-042-22)
- 100 x 4.8 X 9.5 (Item No. 6134-048-95)
- 100 x 4.8 X 13 (Item No. 6134-048-13)
- 50 x 4.8 X 16 (Item No. 6134-039-13)
- 50 x 4.8 X 19 (Item No. 6134-048-16)
- 50 x 4.8 X 22 (Item No. 6134-048-22)
- 50 x 4.8 X 25 (Item No. 6134-048-25)



02

**Assortment of pan head tapping screws**

with Phillips cross recess (form H) with collar and drill point,? DIN 7981 / ISO 7049, galvanized black

► Item no. 1957-135-0

► Contents: 1,103 parts:

- 200 x 4.2 X 13 (Item No. 6135-042-13)
- 200 x 4.2 X 16 (Item No. 6135-042-16)
- 200 x 4.2 X 19 (Item No. 6135-042-19)
- 100 x 4.2 X 25 (Item No. 6135-042-25)
- 200 x 4.8 X 16 (Item No. 6135-048-16)
- 100 x 4.8 X 22 (Item No. 6135-048-22)
- 100 x 4.8 X 35 (Item No. 6135-048-35)
- 3 x HAZET Phillips screwdriver bits? 2215-PH2A (item no. 6135-221-5)





01

**Range of fender washers**

Tolerance according to DIN 522 C, galvanized

## ► Item no. 1957-411

## ► Contents: 1,200 parts

- 100 x 4.3 X 12 X 1.25 (Item No. 6411-4-12)
- 100 x 4.3 X 20 X 1.25 (Item No. 6411-4-20)
- 100 x 5.3 X 15 X 1.25 (Item No. 6411-5-15)
- 100 x 5.3 X 20 X 1.25 (Item No. 6411-5-20)
- 100 x 6.4 X 15 X 1.5 (Item No. 6411-6-15)
- 100 x 6.4 X 18 X 1.5 (Item No. 6411-6-18)
- 100 x 6.4 X 20 X 1.25 (Item No. 6411-6-20)
- 50 x 6.4 X 30 X 1.25 (Item No. 6411-6-30)
- 100 x 6.5 X 25 X 1.25 (Item No. 6411-6-25)
- 50 x 6.5 X 40 X 1.5 (Item No. 6411-6-40)
- 100 x 8.4 X 25 X 1.5 (Item No. 6411-8-25)
- 50 x 8.4 X 30 X 1.5 (Item No. 6411-8-30)
- 100 x 8.5 X 20 X 1.25 (Item No. 6411-8-20)
- 50 x 10.5 X 30 X 1.5 (item no. 6411-10-30)
- 30 x 10.5 X 40 X 2 (Item No. 6411-10-40)
- 50 x 13.0 X 32 X 1.5 (Item No. 6411-12-30)



02

**Steel split pin range**

DIN 94 / ISO 1234, galvanized

## ► Item no. 1957-470

## ► Contents: 1,100 parts:

- 100 x 1.6 x 32 (Item No. 6470-16-32)
- 100 x 2 x 22 (Item No. 6470-2-22)
- 100 x 2 x 32 (Item No. 6470-2-32)
- 100 x 2 x 40 (Item No. 6470-2-40)
- 100 x 3.2 x 20 (Item No. 6470-32-20)
- 100 x 3.2 x 32 (Item No. 6470-32-32)
- 100 x 3.2 x 40 (Item No. 6470-32-40)
- 100 x 4 x 32 (Item No. 6470-4-32)
- 100 x 4 x 40 (Item No. 6470-4-40)
- 100 x 4 x 50 (Item No. 6470-4-50)
- 50 x 5 x 40 (Item No. 6470-5-40)
- 50 x 5 x 50 (Item No. 6470-5-50)





01

**Assortment of blind rivets**

DIN 7337, rivet sleeve: aluminum alloy, rivet mandrel: galvanized steel

► Item no. 1957-937-1

► Contents: 800 parts

- 100 x 3x6 (Item No. 5937-3-6)
- 100 x 3x8 (Item No. 5937-3-8)
- 100 x 4x10 (Item No. 5937-4-10)
- 100 x 4x12 (Item No. 5937-4-12)
- 100 x 4x6 (Item No. 5937-4-6)
- 100 x 4x8 (Item No. 5937-4-8)
- 100 x 3x10 (Item No. 5937-3-10)
- 100 x 4x16 (Item No. 5937-4-16)



02

**Assortment of blind rivet nuts**

aluminum

► Item no. 1957-948

► Contents: 600 parts

- 100 x M4x6 aluminum (item no. 5948-14-20)
- 100 x M5x7 aluminum (item no. 5948-15-30)
- 50 x M6x9 aluminum (item no. 5948-16-30)
- 50 x M8x11 aluminum (item no. 5948-18-30)
- 100 x M4x6 steel (item no. 5949-4-115)
- 100 x M5x7 steel (item no. 5949-5-12)
- 50 x M6x9 steel (item no. 5949-6-145)
- 50 x M8x11 steel (item no. 5949-8-185)





01

**Assortment of button cells**

75-piece

► Item no. 1957-580

► Contents: 75 parts

- 10 x CR1220 3V (item no. 3722-27)
- 10 x CR1616 3V (item no. 3722-26)
- 10 x CR1620 3V (Item No. 3722-25)
- 10 x CR1632 3V (Item No. 3722-30)
- 10 x CR2016 3V (item no. 3722-23)
- 10 x CR2025 3V (item no. 3722-20)
- 10 x CR2032 3V (Item No. 3722-21)
- 5 x LR1 1.5V (4001) (item no. 3722-29)

02

**Assortment tower unequipped**  
stackable, for wall mounting, lockable

► Item no. 1958-100

► Technical specifications

- stackable
- for wall mounting
- lockable
- 5 times
- HxWxD = 360mm x 390mm x 256mm



03

**Assortment box**

made of plastic

► Item no. 1958-001

► Technical specifications

- Width: 320 mm
- Depth: 240 mm
- Height: 49mm



04

**contents**

► Item no. 1957-001-0





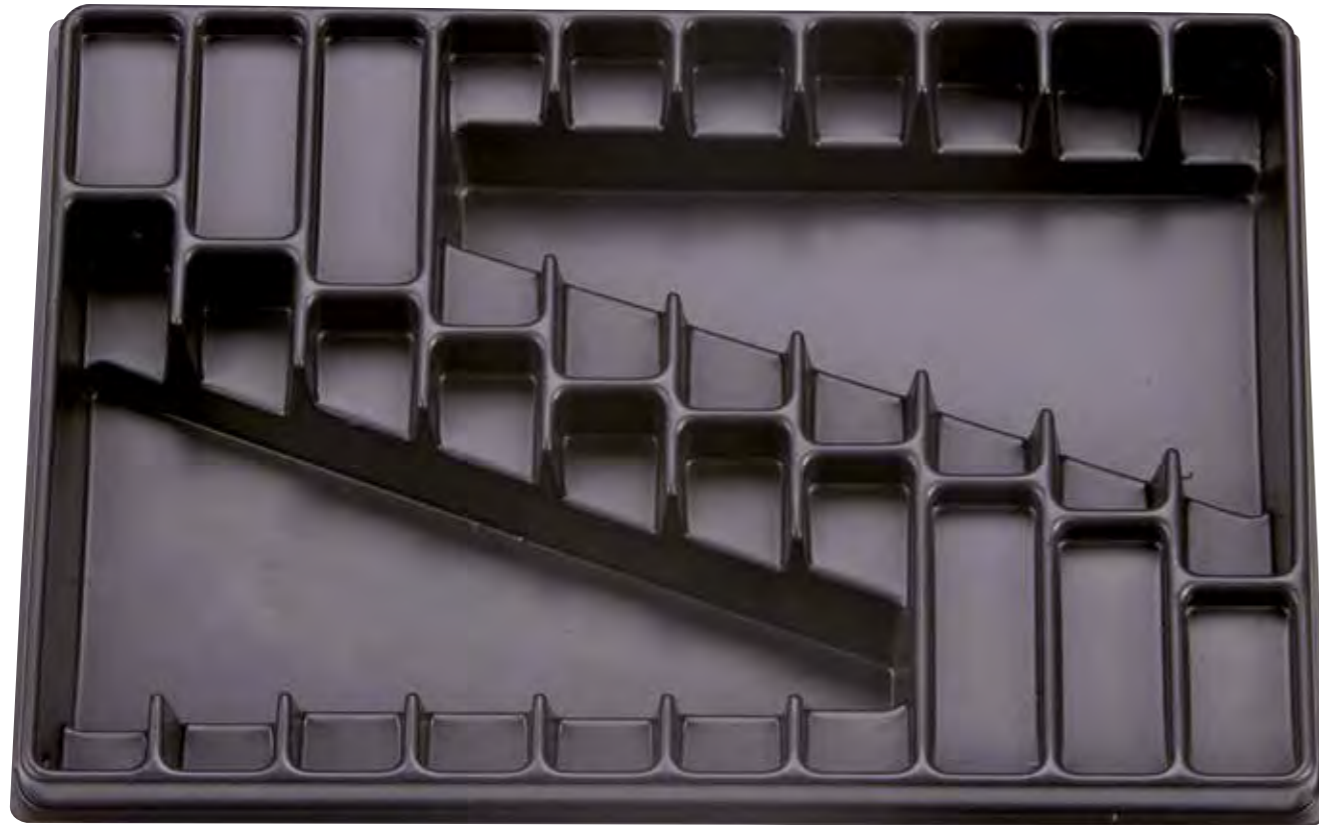

01

**Inlet for assortment box**

for plastic assortment box,? usable for drill bits

► Item no. 1958-001-20

- Width: 320 mm
- Depth: 240 mm
- Height: 49mm



02

**Inlet for assortment box**

with boxes of the same size

► Technical specifications

- with boxes of the same size for filling with small materials
- exactly fitting for plastic assortment box
- width: 310 mm
- depth: 210 mm
- Height: 49 mm

Item No.	execution	PU
1958-001-8	8-fold	1
1958-001-12	12-fold	1
1958-001-16	16-fold	1
1958-001-18	18-fold	1

01

**„Inspection and Maintenance“ starter set**

6 pieces

► Item no. 2897-000-001

► Content:

- 1x Siprem Silicone Premium - silicone spray 400ml (Item 2897-322)
- 1x Teflux - PTFE / ceramic oil spray 400ml (item 2894-445-4)
- 1x Off-Shore Silver - brake protection spray 400ml (item 2894-449)
- 1x TT-Power - dry lubricant 400ml (Item 2897-447)
- 1x High-Press Ultra - high pressure adhesive lubricant 400ml (Item 2894-445-3)
- 1x Super Crack Ultra - ice spray 400ml (Item 2894-442-1)



02

**„Body“ starter set**

6 pieces

► Item no. 2897-000-003

- 1x 1K Multi - Connector primer light 400ml (Item 2893-900)
- 1x Rednox - rust stop primer 400ml (Item 2893-888)
- 1x Protector - cavity protection 400ml (Item 2892-997)
- 1x Long Life - body protection 400 (Item 2892-997-1)
- 1x Rostinator - rust converter 400ml (Art. 2893-903)
- 1x Elox Plus - welding primer 400 ml (Item 2893-906)



03

**„Preparation“ starter set**

6 pieces

► Item no. 2897-000-004

► Content:

- 1x AeroFit Power - odor eliminator 400ml (Art. 2000-309-400)
- 1x Topas - window cleaner 400ml (Art. 2897-310)
- 1x New Wheel Extreme - silicone tire care product 400ml (Art. 2897-338-400)
- 1x Terpanol Power - high-tech special cleaner 400ml (Art. 2897-323)
- 1x Velvet - upholstery cleaner 400ml (Art. 2897-307)
- 1x Crystal Ultra - interior cleaner 400ml (Art. 2897-306)





01

**Interior cleaning set**

15 pieces

► Item no. 2000-001

► Content:

- 3 x interior cleaner Interno, 500 ml (Item No. 2000-05)
- 3 x Stries glass cleaner 500 ml (Item No. 2897-340)
- 3 x Velvet upholstery cleaner 400 ml (Item No. 2897-307)
- 6 x microfibre cloth blue, 40 X 40 cm (Item No. 2000-640-40)



02

**Starter set**

Lubricating greases

► Item no. 2897-000-005

► Content:

- 1 x 400ml high pressure adhesive lubricant High Press (Item No. 2894-445-1)
- 1 x 400ml high pressure adhesive lubricant High Press black (Art.-No. 2894-445-2)
- 1 x 400ml high pressure adhesive lubricant High Press ultra (Art.-No. 2894-445-3)
- 1 x 400ml high pressure adhesive lubricant High Press Protect (Art.No. 2894-445-5)
- 1 x 400ml lubricating grease white Bio-Top Protect (Item No. 2894-446)
- 1 x 400ml Siltron silicone grease (item no. 2897-324)



03

**Exterior cleaning set Cleeno**

9 pieces

► Item no. 2000-002

► Content:

- 1 x All Star 5 liters (Item No. 2000-312-5)
- 1 x Rimol Profi Alloy Wheel Cleaner 5 liters (Item No. 2897-321-5)
- 2 x spout tap for 5 liter containers (item no.2000-000-005)
- 1 x pressure pump spray bottle blue 1 liter for All-Star (Item No. 2000-100)
- 1 x pressure pump spray bottle black 1 liter for Rimol Profi (item no. 2897-333-150)
- 1 x cleaning glove „chemistry“ GR. 9 (Item no.7797-009-9)
- 1 x cleaning glove „chemistry“ GR. 10 (Item No. 7797-009-10)
- 1 x VISION Protect protective goggles (Item No. 7794-005-0)



04

**„Protect“ starter set**

6 parts

► Item no. 2897-000-002

► Content:

- 1x Oxim Protect - rust remover 400ml (Art. 2894-444-1)
- 1x High Press Protect - high pressure adhesive lubricant 400ml (Art. 2894-445-5)
- 1x Multi Protect - maintenance oil spray 400ML (Art. 2894-445-6)
- 1x Bio-Top white Protect - lubricating grease 400ml (Art. 2894-446)
- 1x New Look Protect - cockpit care 400ml (Art. 2897-337-1)
- 1x Anitolox Protect - welding protection 400ml (Art. 2893-908)







01  
**Starter set**  
Repos

- ▶ Item no. 2700-001
- ▶ Content: 13 pieces

- ▶ Contents:
- 2 x Repos, synthetic glue, 50 ml (art. no. 2700-10)
- 2 x Repos fast, synthetic glue, 50 ml (art. no. 2700-15)
- 2 x Repos MMA, structural glue, 50 ml (art. no. 2700-20)
- 1 x Cartridge gun (art. no. 2700-70)
- 6 x Rod mixer square blue (art. no. 2700-42)



02  
**Glue starter set**  
7 pieces

- ▶ Item no. 1957-600



- ▶ Content:
- ▶ 1 pc. 2898-554 Fixit superglue gel 20g
- ▶ Fixit is a special superglue in thixotropic form (gel). Does not run, can also be processed in horizontal and vertical places. Possible bonding of metals, wood and plastics.
- ▶ 1 pc. 2898-554-150 Fixit Active hardening accelerator 200ml
- ▶ The hardening accelerator from Normfest ensures even faster hardening of all CA adhesives. This hardening accelerator is sprayed onto one side of the materials to be joined, the CA adhesive is applied to the other side, and both parts are immediately joined together. It is suitable for leather, wood, cork, ceramic and all porous materials and plastic compounds.
- ▶ 1 pc. 2898-555-100 Rapido 20g
- ▶ Is an impact, tensile, peel and heat resistant superglue for extreme loads. Six times higher impact strength and 10 times higher peel strength than conventional CA adhesives. Rapido is ideally suited to firmly bond a wide variety of materials that are also exposed to strong vibrations.
- ▶ 1 pc. 2898-556 super fast superglue 20g
- ▶ Superfast is a low-viscosity (thin liquid) superglue that is used for the extremely fast instant gluing of smooth surfaces made of plastic and / or rubber with a precise application option.
- ▶ 1 pc. 2898-560-30 Mineral filler 30g
- ▶ The filler is a special granulate made of silicon dioxide. It enables the enlargement and stabilization of small adhesive surfaces. The filler fills holes, cracks, evens out unevenness, strengthens the smallest parts, becomes rock-hard, can be sanded and painted over. The best and fastest bonding reaction is achieved with the Superfast instant adhesive (2898-55...) from Normfest.
- ▶ 1 pc. 2898-560-20 superglue black medium viscosity 20g
- ▶ Vibration and impact resistant, special CA adhesive for bonding rubber linings, plastics and metals.



01

**Promotion Set Aquano 2020**

7 pieces

► Item no. 2897-500-003

► Contents:

- 1 x AQUANO Sens hand washing paste 2 liters
- 1 x AQUANO Protect skin protection 2 liters
- 1 x AQUANO lotion skin care 2 liters
- 1 x skin protection plan
- AQUANO dispenser for 2 liter soft bottles (Item No. 2897-500-6)
- Skin protection plan (Art.-No. 2897-500-71)



02

**Promotion set Aquano touchless**

4 parts

► Item no. 2897-500-002

► Contents:

- 2 x AQUANO touchless dispensers for 1 liter containers
- 1 x AQUANO FOAM foam soap 1 liter
- 1 x AQUANO disinfectant gel 1 liter





01

**Cable tie set, small**

1,800 black cable ties with plastic tongues, 6 different sizes

► Item no. 3502-001

► Contents: 1,800 black cable ties with plastic tongues

► 300 pieces each in the following sizes:

- 2.5mm x 98mm (Item No. 3502-111)
- 3.5mm x 140mm (Item No. 3502-121)
- 3.5mm x 200mm (Item No. 3502-131)
- 3.6mm x 290mm (Item No. 3502-135-1)
- 4.5mm x 178mm (Item No. 3502-141)
- 4.5mm x 280mm (Item No. 3502-151)

02

**Cable tie set large**

1,000 black cable ties with plastic tongues, 6 different sizes

► Item no. 3502-002

► Contents: 1,000 black cable ties with plastic tongues

► 300 pieces each in the following sizes:

- 
- 4.5mm x 350mm (Item No. 3502-161)
- 7.6mm x 200mm (Item No. 3502-171)
- 7.5mm x 360mm (Item No. 3502-181)
- 
- 100 pieces in the following size:
- 7.8mm x 750mm (Item No. 3502-191)



03

**12V Normlight lamp set for equipping the lamp cabinet**

► Item no. 3723-001

► Contents: 390 parts

- 40 x 10W tail light lamp (item no. 3723-050-08)
- 40 x 5W glass base lamp (item no. 3723-028-25)
- 40 x 1.2W glass base lamp (item no. 3723-027-21)
- 30 x 5W festoon lamp 11x35MM (item no. 3723-064-18)
- 50 x 21W indicator or brake light (item no. 3723-075-06)
- 50 x 21 / 5W brake or tail light (item no. 3723-075-28)
- 40 x 21W yellow indicator lamp (item no. 3723-075-07)
- 10 x H4 car lamp 60 / 55W (item no. 3723-064-193)
- 50 x 5W tail light lamp (item no. 3723-050-07)
- 20 x H7 car lamp 55W (item no. 3723-064-201)
- 20 x H7 car lamp Long Life (item no. 3723-064-209)





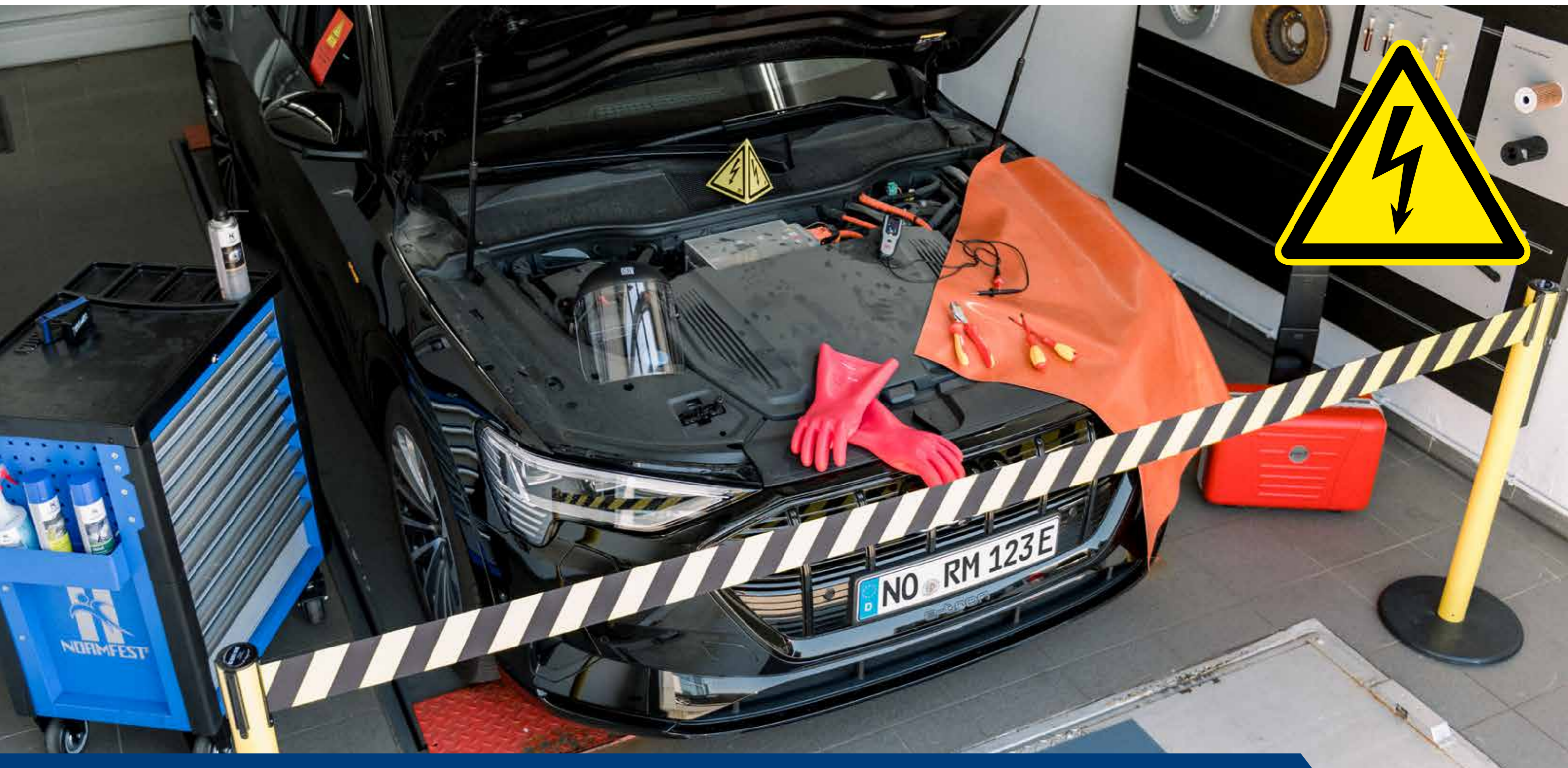





01  
**Electrician's gloves „ELECTRIC“**

- ▶ Item no. 7797-020-9 | Size 9
- ▶ Item no. 7797-020-10 | Size 10

- ▶ **Technical specifications**
  - insulating glove made of red natural latex
  - Protection against voltage of up to 1000 volts
  - CE CATEGORY: III irreversible damage
  - conforms to the standards: EN 60903-2003, CEI 903-2002
  - Category AZCv
  - Length: 41cm
  - Thickness: 1mm
  - Harmlessness: Corresponds to European standards
  - Tactile feeling: class 0



02  
**Inner gloves**

- ▶ Item no. 7900-2-3

- ▶ **Technical specifications**
  - Undergloves to improve the wearing comfort under the insulating gloves
  - Manufactured without a seam
  - maximum comfort
  - Material: 100% cotton (Gauge: 13)
  - Elastic cuffs
  - Production without DMF (DMF is carcinogenic)
  - Weight: approx. 28 g



03  
**Voltage tester**  
Category 4

- ▶ Item no. 7900-1-5
- ▶ **Technical specifications**
  - suitable for indoor and outdoor use
  - acoustic and optical device that enables voltage detection
  - AC and DC voltage level control
  - Continuity test for voltage-free circuits with a warning tone
  - Unipolar detection of the phase
  - Polarity detection of a direct current circuit
  - 8 voltage thresholds:
    - In AC mode: 12, 24, 50, 127, 230, 400, 600, 900 V.
    - in DC mode: 12, 24, 50, 127, 230, 400, 700, 1000 V
  - corresponds to EN 61243-3 and the European standard NF C 18-510



04  
**Case for voltage tester**

- ▶ Item no. 7900-1-6
- ▶ **Technical specifications**
  - Canvas case
  - suitable for the voltage tester item no. 7900-1-5
  - with belt loop
  - Dimensions: 180 x 70 x 45 mm

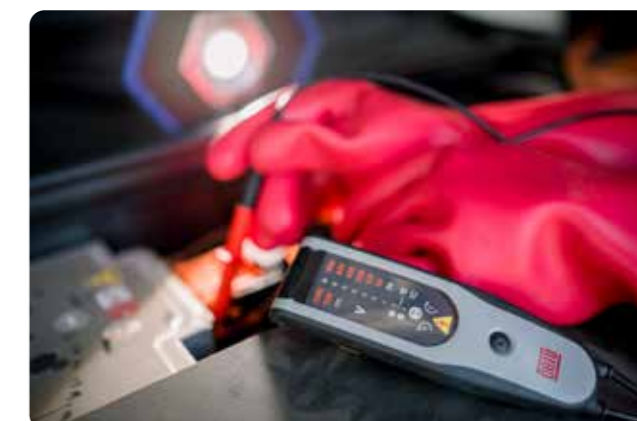



01

**Box for insulating gloves**

## ▶ Item no. 7900-1-3

## ▶ Technical specifications

- Storage and protective box for insulating gloves of all classes (from class 00 to class 4)
- provides mechanical protection for the gloves against impacts, punctures and UV rays
- Material: break-proof and UV-resistant polypropylene
- Visibility of the gloves through the transparent cover
- red housing, clearly visible
- to be used for wall mounting or as a transport box
- quick fastening of the gloves with Velcro® tape
- Self-adhesive label with maintenance recommendations for the gloves according to IEC 60903
- Talc (makes it easier to put on)
- 3 mounting holes (140 x 260 mm)
- Dimensions: 101 x 224 x 476 mm
- Weight: 770 g



02

**Insulating overshoes**

## ▶ Item no. 7900-2-2

## ▶ Technical specifications

- Overshoes with electrical insulation
- protect the wearer from the risk of a current flowing from the feet to the ground or a step tension
- suitable for temporary and frequent use
- Size L (43-45)



03

**Face shield with disc**

## ▶ Item no. 7900-2-1

## ▶ Technical specifications

- colorless lens according to EN 170 made of high-impact polycarbonate, thickness 1.5 mm, anti-fog
- with adjustable headband (ratchet)
- Approved for protection against arcing (according to EN166 and IEC 61482-1-2 / GS-ET29 class 1)
- Marking: 2-1.2CATU 1 B 8 1000 V
- Dimensions: 230 x 290 mm (length x height)
- Weight: 400 g



04

**Protective bag for face shield (Item No. 7900-2-1)**

## ▶ Item no. 7900-2-6

## ▶ Technical specifications

- black
- with drawstring
- reusable



01

**Insulating protective cover**

▶ Item no. 7900-2-4

## ▶ Technical specifications

- suitable for work under tension
- for covering live parts
- made of orange EPDM (= ethylene-propylene-diene rubber)
- continuous marking
- AC voltage: 1,000 V
- DC voltage: 1,500 V.
- Dimensions: 1 x 1 m
- Weight: 1.5kg
- Thickness: 1 mm



02

**Mounting brackets (2 pieces)**

▶ Item no. 7900-2-5

## ▶ Technical specifications

- for attaching protective drapes and EPDM protective drapes
- Length: 80mm
- Weight: 30g
- 2 pieces in the packaging unit



03

**Belt barrier post**

▶ Item no. 7900-1-17

## ▶ Technical specifications

- complete belt barrier post
- easy installation for delimiting areas and barring off rooms
- yellow plastic post
- Cast iron base plate including plastic cover
- Nylon strap, black / yellow
- 4-way belt cassettes with 3-way docking gently pull the belt in and increase the service life
- Height: 900 mm
- Belt: 100 mm x 3,800 mm (width x length)
- Weight: 8 kg



04

**Insulating mat**

▶ Item no. 7900-1-15

## ▶ Technical specifications

- On-site insulation mat for work in areas of tension
- made of gray polymer plastic
- one-sided corrugated anti-slip surface
- Continuous marking in accordance with the IEC 61111 standard: Article number, class, month / year of manufacture, field for repeat testing, „CATU“ logo, IEC logo double triangle
- Complies with RoHS2 and REACH guidelines
- halogen free
- AC voltage: 1,000 V
- DC voltage: 1,500 V.
- Thickness: 2 mm
- Dimensions: 1,000 x 600 mm
- Weight: 1.4 kg



05

**Straps for insulating mat**

▶ Item no. 7900-1-16

## ▶ Technical specifications

- Instructions in accordance with the IEC 61111 standard
- with Velcro fastener
- Dimensions: 530 x 38 mm





01

**Lockable station**

## ▶ Item no. 7900-1-13

## ▶ Technical specifications

- with two interchangeable shelves and slotted side panels
- made of special sheet metal
- 4 holes for wall mounting
- Dimensions: 405 x 355 x 156 mm
- Weight: 5.6 kg



02

**Barrier for machine remote control**

## ▶ Item no. 7900-1-7

## ▶ Technical specifications

- Based on DIN EN 60204
- DGUV-Information 200-005, BGVA3
- Belt with 6 holes (ø 11mm), lockable with locks
- Prohibition signs „Do not switch“ and „Do not touch“ according to EN ISO 7010
- Canvas bag
- Leather belt
- Dimensions: 460 x 210 mm



03

**padlock**

## ▶ Item no. 7900-1-14

## ▶ Technical specifications

- robust and light
- 6 mm plastic bracket
- Key lock
- Supplied with 2 keys



04

**Barrier of plug connection (small)**

## ▶ Item no. 7900-1-8

## ▶ Technical specifications

- Based on DIN EN 60204
- DGUV-Information 200-005, BGVA3
- specially developed for locking all types of connectors
- Cable diameter up to 12 mm
- Locking with 1 to 2 padlocks (lock shackle max. 9 mm Ø)
- Prohibition signs according to EN ISO7010
- Made from polystyrene
- Dimensions: 88 x 50 x 50 mm
- Weight: 56 g



05

**Barrier of plug connection (large)**

## ▶ Item no. 7900-1-9

## ▶ Technical specifications

- Based on DIN EN 60204
- DGUV-Information 200-005, BGVA3
- specially developed for locking all types of connectors
- Cable diameter up to 25 mm
- Locking with 1 to 4 padlocks (lock shackle max. 9 mm Ø)
- Prohibition signs according to EN ISO7010
- Made from polystyrene
- Dimensions: 171 x 83 x 83 mm
- Weight: 211 g



01

**Tetrahedral warning sign**

▶ Item no. 7900-1-2

▶ Technical specifications

- „Warning of dangerous electrical voltage“ according to DIN EN ISO 7010 W012 on three pages
- Tetrahedral warning sign „lightning arrow“
- with magnetic base



03

**Warning sign „Warning of electrical voltage“**

▶ Item no. 7900-1-1

▶ Technical specifications

- according to ASR A1.3 / W012, DIN EN ISO 7010 / W012
- for indoor and outdoor use
- stable, unbreakable, non-flammable
- Material: aluminum
- Leg length 200 mm per side
- Fixing through 3 holes with Ø 4.5 mm



04

**Rescue pole with wall bracket**

▶ Item no. 7900-1-10

▶ Technical specifications

- insulated rescue pole for rescuing people from the danger area in the event of electrical accidents
- for use indoors and outdoors, but not in precipitation
- one-piece rescue bar
- Glass fiber / polyester resin tube with hand limiting disc
- Bridging-safe and permanently mounted rescue hook
- Rescue of people up to a weight of 150 kg
- Torque test (hook): 30 N.m.
- Delivery incl. Wall bracket
- Length: 1650 mm
- Weight: 1 kg
- Nominal voltage: 45 kV



05

**Isolated telescopic pole**

▶ Item no. 7900-2-7

▶ Technical specifications

- telescopic, isolating earthing and operating rod
- for attaching and detaching earthing and short-circuiting devices
- for operating and checking live parts
- Suitable for indoor and outdoor use, but not in precipitation
- PVC pipe; with hexagonal coupling (SW 12mm)
- Nominal voltage: 45kV
- Total length: 1.5 m
- Transport length: 0.64 m
- Number of elements: 3
- Weight: 0.9kg



06

**Lifebuoy**

for telescopic pole item 7900-2-7

▶ Item no. 7900-2-8







01

**Tool set for hybrid and electric vehicles**
 10 3/8 10 3/8 
► **Item no. 8000-173-204**► **Technical specifications**

- In a trolley case
- Joint development with one of the leading automobile manufacturers and in coordination with TÜV-Süd
- Pulling or pushing possible
- Rubber-coated, mounted large track rollers
- Stable due to wide wheelbase
- Airworthy, robust suitcase shells made of break-resistant X-ABS
- With double aluminium frame
- Durable tool boards
- Roller case with 4x telescopic pull-out from 950 - 1,150 mm
- Load capacity: up to 40 kg
- Dimensions (not extended): H 310 x W 460 x D 190 mm
- Weight, empty: 6.2 kg
- Hazet number 150/43

- **Content:**

- 5 end caps diameter 10 mm and 20 mm each
- 2 warning signs „Hybrid“, „Hybrid switch
- 500 m barrier tape (width 50 mm)
- 10 VDE screwdriver:
  - for slotted screws 2.5 - 3 - 3.5 - 4 mm
  - for cross-head screws (PH) PH 1 - PH 2 - PH 3
  - for inside TORX® screws T 20 - T 25 - T 30
- 15 VDE Socket spanner inserts square drive 10 = 3/8 inch 6 - 22 mm
- 3 VDE for multi-toothed socket screws (XZN) Screwdriver bits square drive 10 = 3/8 inch M 8 - M 10 - M 12
- 2 VDE extensions inner square drive 10 = 3/8 inch 74 and 126 mm
- 1 VDE reversible ratchet external square drive 10 = 3/8 inch
- 1 VDE Universal pliers 250 mm
- 1 VDE Power side cutter 180 mm
- 1 VDE Lever side cutter 160 mm
- 1 VDE Flat nose pliers 160 mm
- 1 VDE Flat-round pliers, obtuse-angled bent 200 mm
- 1 VDE Combination pliers 200 mm
- 1 VDE Cable and stripping knife
- 1 trolley case

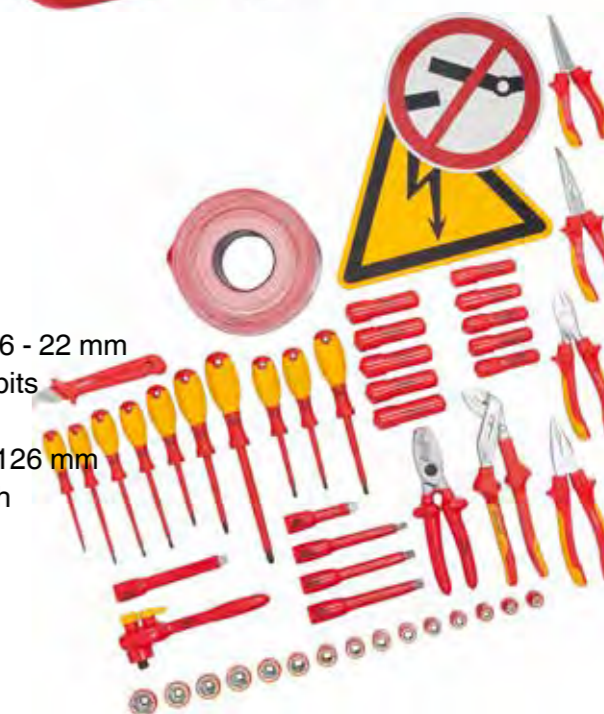





01  
**HAZET socket wrench set with protective insulation**        
 41 pieces

► Item no. 8000-223-855

► Technical specifications

- IEC 60900:2018
- Drive: square hollow 10 mm (3/8 inch)
- Output: External hexagonal traction profile, internal TORX® profile, internal hexagonal profile, internal multi-tooth profile XZN
- spanner size: 6-22; T10-T50
- protective insulation up to 1000V
- Arrangement system Size: 2/3+ (344 x 392 mm)
- HAZET number: 163-545/41



02  
**HAZET socket wrench set with protective insulation**       
 26 pieces

► Item no. 8000-223-848

► Technical specifications

- IEC 60900:2018
- Drive: square hollow 12.5 mm (1/2 inch)
- Output: outer hexagonal traction profile, inner hexagonal profile
- spanner size: 10 - 32
- protective insulation up to 1000V
- Arrangement system Size: 2/3+ (344 x 392 mm)
- HAZET number: 163-544/26



01

**HAZET spanner set with protective insulation**  
18 pieces

▶ Item no. 8000-223-626



▶ Technical specifications

- IEC 60900:2018
- Output: External hexagonal profile
- spanner size: 7 - 32
- protective insulation up to 1000V
- Arrangement system Size: 2/3+ (344 x 392 mm)
- Hazet number: 163-542/18



02

**HAZET ring spanner set with protective insulation**  
18 pieces

▶ Item no. 8000-223-831



▶ Technical specifications

- IEC 60900:2018
- Output: External hexagonal profile
- spanner size: 7 - 32
- protective insulation up to 1000V
- Arrangement system Size: 2/3+ (344 x 392 mm)
- Hazet number: 163-543/18 Außen-Doppel-Sechskant Profil
- IEC 60900:2018
- Output: External hexagonal profile
- spanner size: 7 - 32
- protective insulation up to 1000V
- Arrangement system Size: 2/3+ (344 x 392 mm)
- Hazet number: 163-543/18



03

**HAZET socket wrench set with protective insulation**  
18 pieces

10 3/8"

▶ Item no. 8000-235-520

▶ Technical specifications

- IEC 60900:2018
- Drive: square hollow 10 mm (3/8 inch)
- Output: External double hexagonal traction profile
- spanner size: 8 - 22
- protective insulation up to 1000V
- Organising system Size: 1/3 (342 x 172 mm) / SmartCase L
- Hazet number: 163-580/18



05

**HAZET pliers set with protective insulation**  
3-part

▶ Item no. 8000-177-868

▶ Technical specifications

- IEC 60900:2018
- VDE protective insulation up to 1000V
- Organising system Size: 1/3 (342 x 172 mm) / SmartCase L
- Hazet number 163-227/3

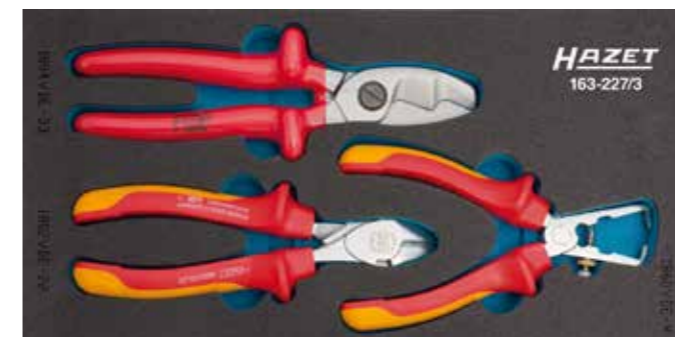

04

**HAZET screwdriver set with protective insulation**  
7 pieces

▶ Item no. 8000-177-844

▶ Technical specifications

- IEC 60900:2018
- Output: Cross recess profile PH, slotted profile
- Width across flats: 0.4 x 2.5 - 0.8 x 4, PH1 - PH3
- VDE protective insulation up to 1000V
- Organising system Size: 1/3 (342 x 172 mm) / SmartCase L
- Hazet number 163-229/7



06

**HAZET pliers set with protective insulation**  
4 parts

▶ Item no. 8000-177-875

▶ Technical specifications

- IEC 60900:2018
- VDE protective insulation up to 1000V
- Organising system Size: 1/3 (342 x 172 mm) / SmartCase L
- Hazet number 163-226/4





01

**HAZET screwdriver set with protective insulation**

12 pieces

▶ Item no. 8000-223-619



▶ Technical specifications

- IEC 60900:2018
- Output: Cross recessed profile PH, inside TORX® profile, slotted profile
- Width across flats: 0.4 x 2.5 - 0.8 x 4, PH1 - PH2, T20 - T30
- VDE protective insulation up to 1000V
- Arrangement system Size: 2/3 (344 x 342 mm)
- Hazet number: 163-546/12



02

**HAZET screwdriver set with protective insulation**

14 pieces

▶ Item no. 8000-133-000



▶ Technical specifications

- Safety tool according to DIN ISO 60900
- for butterfly profile 2.5 x 0.4 · 3.0 x 0.5 · 3.5 x 0.6 · 4.0 x 0.8 · 5.5 x 1.0 · 6.5 x 1.2
- for double hexagonal profile PH 1 · PH 2
- for Pozidriv profile (PZ) PZ 2
- for inside TORX® Profile T 10 · T 15 · T 20
- All screwdrivers 10,000 Volt each, guaranteed safe working up to 1,000 Volt
- Round blade
- SmartCase (1/3)
- Ergonomic HAZET 2-component handle (red/yellow)
- IEC 60900:2018
- Output: Pozidriv profile PZ, cross recess profile PH, internal hexagonal profile, slotted profile
- VDE protective insulation up to 1000V
- Hazet number: 804 VDE/14



03

**HAZET electrician's tool set**

8 pieces

▶ Item no. 8000-234-561



▶ Technical specifications

- IEC 60900:2018
- Output: slotted profile, cross slotted profile PH
- VDE protective insulation up to 1000V
- Hazet number: 1802VDE/8



04

**HAZET screwdriver set with protective insulation**

6 pieces

▶ Item no. 8000-179-329



▶ Technical specifications

- Voltage tester, 220 - 250 V according to VDE 0680
- IEC 60900:2018
- Output: slotted profile, cross slotted profile PH
- Width across flats: 0.4 x 2.5 - 0.8 x 4, PH1 - PH2
- VDE protective insulation up to 1000V
- Hazet number: 810/6VDE

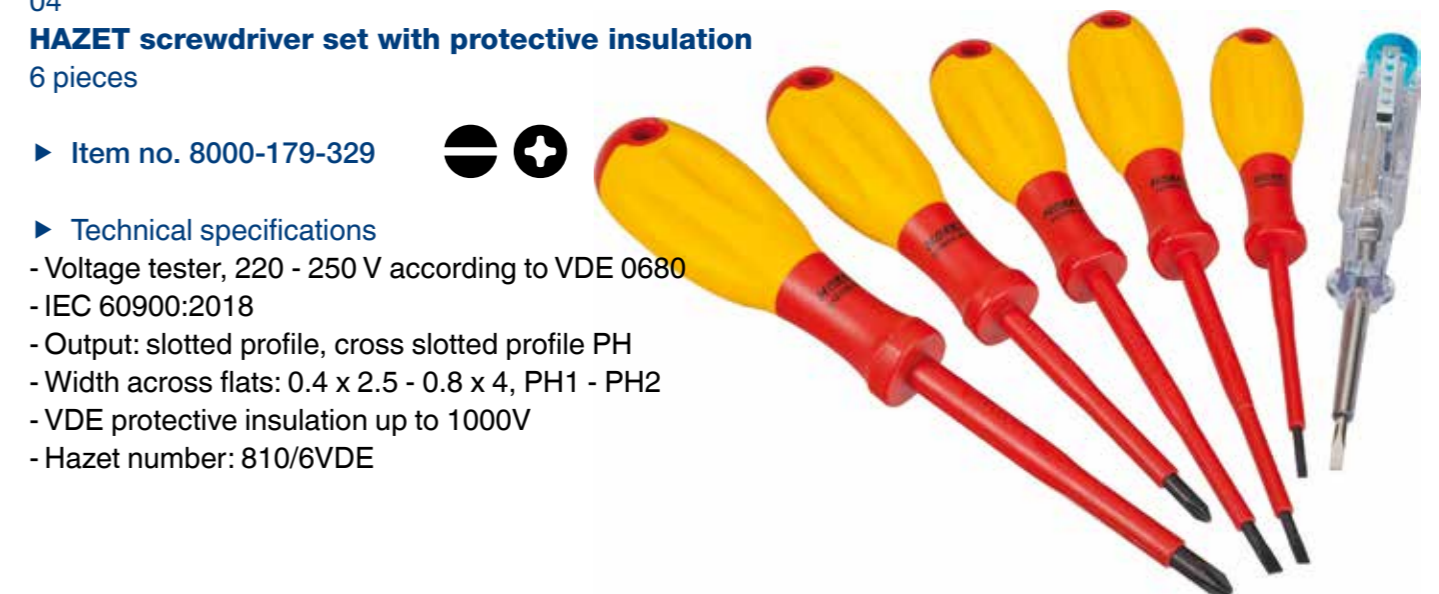



01

**HAZET torque wrench with protective insulation** 10 3/8" 12<sup>5</sup> 1/2"

▶ Item no. 8000-235-421 | 2-10 Nm

▶ Item no. 8000-235-445 | 5-25 Nm

▶ Item no. 8000-233-397 | 20-120 Nm

▶ **Technical specifications**

- Readjustable and calibrateable
- Long life / accuracy due to the possibility of disassembly, adjustment, repair (if necessary), calibration and assembly
- Suitable for test equipment monitoring
- Fine scale division with vernier
- Lock against unintentional adjustment of the setting value
- Right/left release by means of a square socket, thus tightening with set torque both to the right and to the left within the specified tolerance
- Low weight for good handling and fatigue-free work
- Slim design in strict compliance with the required insulation factors (material thickness / overlaps)
- Smooth transitions on switching and moving parts with ergonomic handle design and clear calibration groove
- Colourful design of housing and head with signal colours red / yellow
- Handle colour in black for colour differentiation and against too fast optical soiling
- Avoidance of protruding, disturbing parts (e.g. changeover levers)
- DIN EN ISO 6789-2:2017, DIN 3120, ISO 1174-1, IEC 60900:2018
- ATTENTION: Repairs may only be carried out by the HAZET service centre, as a 10,000 V routine test according to IEC 60900 must be carried out subsequently



**2-10 Nm**  
10 3/8"  
Hazet-Nr.  
5108KV

**5-25 Nm**  
10 3/8"  
Hazet-Nr.  
5109KV

**20-120 Nm**  
12 1/8"  
Hazet-Nr.  
5121KV



Downforce	Length	tolerance	Tightening torque max.	Graduation (Nm)	Actuating force max. Kg	Weight kg
Solid square 10 mm (3/8 inch)	275 mm	6	10 Nm	0.2 Nm	5.0 kg	0,59
Solid square 10 mm (3/8 inch)	305 mm	4	25 Nm	0.5 Nm	11.0 kg	0,64
Solid square 12.5 mm (1/2 inch)	420 mm	4	120 Nm	1 Nm	37.4 kg	1,47

01

**HAZET reversible ratchet double insulated 10.0 mm (3/8 inch) Item no. 8000-235-469**

10 3/8"



► Technical specifications

- Number of teeth: 30
- Angle of actuation: 12°.
- With ball lock
- IEC 60900:2018
- Output: solid square 10 mm (3/8 inch)
- Dimensions / length: 194 mm
- protective insulation up to 1000V
- Hazet number: 8816KV



02

**HAZET Screwdriver Socket Internal Multi-tooth XZN Technical specifications**

10 3/8"

- Long version
- IEC 60900:2018
- Drive: square hollow 10 mm (3/8 inch)
- Output: Internal multi-tooth profile XZN
- protective insulation up to 1000V



MSPX art. No.	Length I1	Length I2	Ø (d) mm	Output size	Manufacturer Item No.:
8000-231-836	100 mm	145.5 mm	23 mm	M8	8808LG-8KV
8000-231-812	100 mm	144.5 mm	23 mm	M10	8808LG-10KV
8000-231-829	100 mm	145.3 mm	23 mm	M12	8808LG-12KV

03

**HAZET screwdriver socket inner hexagon**

10 3/8"



► Technical specifications

- Short version
- IEC 60900:2018
- Drive: square hollow 10 mm (3/8 inch)
- Output: Internal hexagonal profile
- protective insulation up to 1000V

MSPX art. No.	Length I1	Length I2	Ø (d) mm	Key-width:	Manufacturer Item No.:
8000-231-621	12.5 mm	60 mm	23 mm	6 mm	8801K-6KV
8000-231-614	12.5 mm	60 mm	23 mm	5 mm	8801K-5KV

04

**HAZET socket spanner insert external hexagon**

10 3/8"



► Technical specifications

- Short version
- IEC 60900:2018
- Drive: square hollow 10 mm (3/8 inch)
- Output: External hexagonal traction profile
- protective insulation up to 1000V

MSPX art. No.	Length	Ø d1 (at the output)	Ø d2 (at the drive)	depth	Manufacturer Item No.:
8000-231-959	40 mm	14 mm	23 mm	6.5 mm	880KV-6
8000-231-966	40 mm	15 mm	23 mm	6.5 mm	880KV-7
8000-231-973	40 mm	16 mm	23 mm	6.5 mm	880KV-8
8000-231-980	40 mm	17.5 mm	23 mm	6.5 mm	880KV-9
8000-231-843	41 mm	18.5 mm	23 mm	7.3 mm	880KV-10
8000-231-850	42 mm	20 mm	23 mm	8.4 mm	880KV-11
8000-231-867	43 mm	21 mm	23 mm	9.3 mm	880KV-12
8000-231-874	43.5 mm	22.5 mm	23 mm	9.8 mm	880KV-13
8000-231-881	45.5 mm	23.5 mm	23 mm	11.8 mm	880KV-14
8000-231-898	45.5 mm	26 mm	23 mm	11.7 mm	880KV-16
8000-231-904	45.5 mm	27.5 mm	23 mm	11.7 mm	880KV-17
8000-231-911	47.5 mm	28.5 mm	23 mm	13.7 mm	880KV-18
8000-231-928	47.5 mm	30 mm	23 mm	13.7 mm	880KV-19
8000-231-935	47.5 mm	31 mm	23 mm	13.7 mm	880KV-20
8000-231-942	50 mm	33.5 mm	23 mm	15.6 mm	880KV-22

05

**HAZET extension square 10 mm (3/8 inch)**

10 3/8" 10 3/8"



► Technical specifications

- With ball lock
- IEC 60900:2018
- Drive: square hollow 10 mm (3/8 inch)
- Output: solid square 10 mm (3/8 inch)
- protective insulation up to 1000V

MSPX art. No.	Length	Ø d1 (at the output)	Ø d2 (at the drive)	Manufacturer Item No.:
8000-231-997	90 mm	17.5 mm	23 mm	8821KV-3
8000-232-000	142 mm	17.5 mm	23 mm	8821KV-5

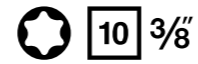

01

**HAZET Screwdriver Socket Interior TORX®**

## ► Technical specifications

- short version
- IEC 60900:2018
- Drive: square hollow 10 mm (3/8 inch)
- Output: Inside TORX® Profile
- protective insulation up to 1000V

MSPX art. No.	Output size	Length l1	Length l2	Ø (d) mm	Manufacturer Item No.:
8000-231-720	T10	12.5 mm	59.5 mm	23 mm	8802KV-T10
8000-231-737	T15	12.5 mm	59.5 mm	23 mm	8802KV-T15
8000-231-744	T20	12.5 mm	59.5 mm	23 mm	8802KV-T20
8000-231-751	T25	12.5 mm	59.5 mm	23 mm	8802KV-T25
8000-231-768	T27	12.5 mm	59.5 mm	23 mm	8802KV-T27
8000-231-775	T30	12.5 mm	59.5 mm	23 mm	8802KV-T30
8000-231-782	T40	12.5 mm	59.5 mm	23 mm	8802KV-T40
8000-231-799	T45	12.5 mm	59.5 mm	23 mm	8802KV-T45
8000-231-805	T50	12.5 mm	60.5 mm	23 mm	8802KV-T50

02

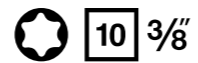
**HAZET Screwdriver Socket Interior TORX®**

## ► Technical specifications

- Long version
- IEC 60900:2018
- Drive: square hollow 10 mm (3/8 inch)
- Output: Inside TORX® Profile
- protective insulation up to 1000V

MSPX art. No.	Output size	Length l1	Length l2	Ø (d) mm	Manufacturer Item No.:
8000-231-638	T10	153 mm	187 mm	23 mm	8802KV-LG-T10
8000-231-645	T15	153 mm	187 mm	23 mm	8802KV-LG-T15
8000-231-652	T20	153 mm	187 mm	23 mm	8802KV-LG-T20
8000-231-669	T25	153 mm	187 mm	23 mm	8802KV-LG-T25
8000-231-676	T27	153 mm	187 mm	23 mm	8802KV-LG-T27
8000-231-683	T30	153 mm	187 mm	23 mm	8802KV-LG-T30
8000-231-690	T40	153 mm	187 mm	23 mm	8802KV-LG-T40
8000-231-706	T45	153 mm	187 mm	23 mm	8802KV-LG-T45
8000-231-713	T50	153 mm	187 mm	23 mm	8802KV-LG-T50

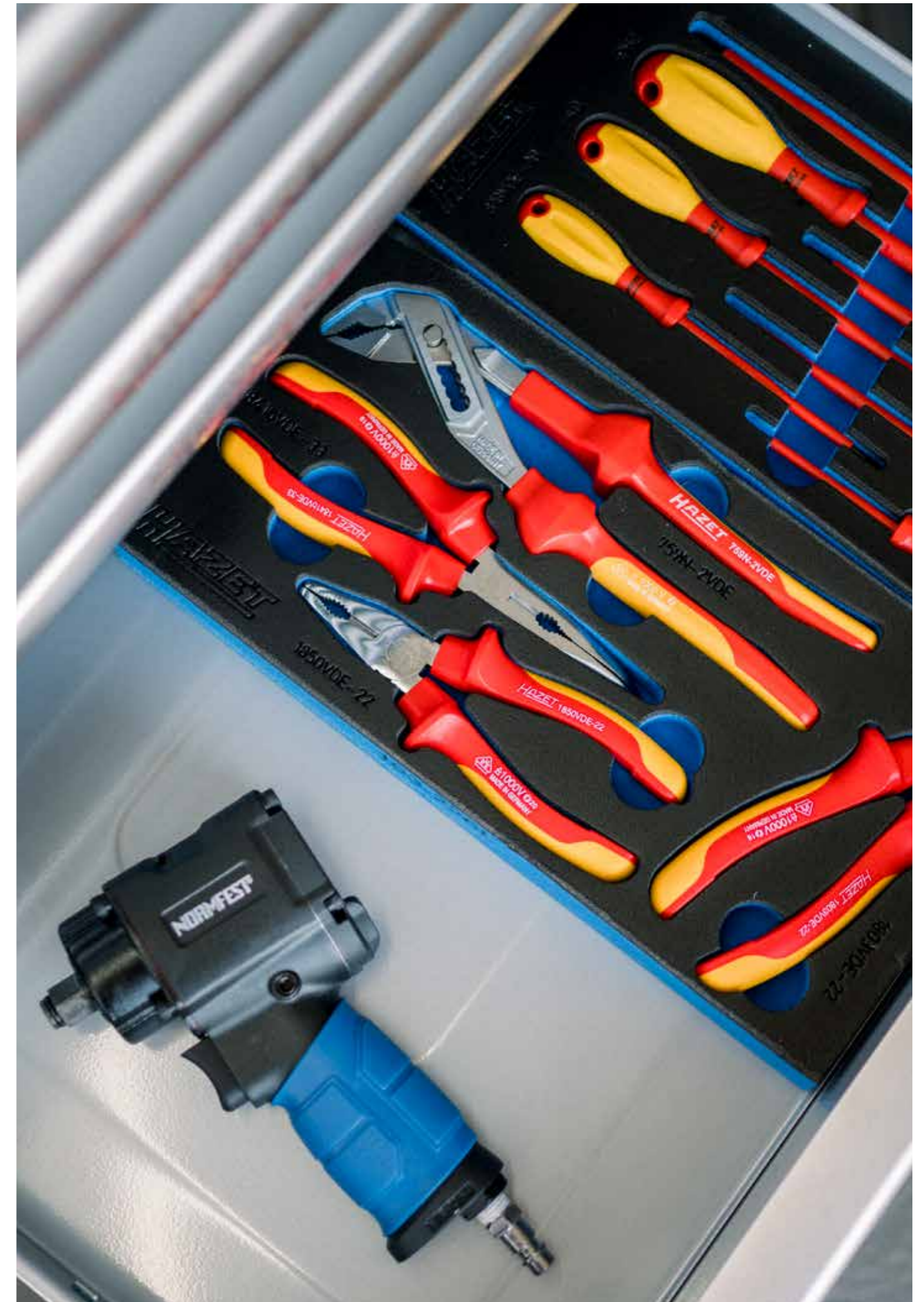





**01 HAZET reversible ratchet double insulated 12.5 mm (1/2 inch)**

12.5 1/2"

► Item no. 8000-232-260

► Technical specifications

- Number of teeth: 30
- Angle of actuation: 12°.
- With ball lock
- IEC 60900:2018
- Output: Solid square 12.5 mm (1/2 inch)
- Dimensions / length: 260 mm
- protective insulation up to 1000V
- Hazet number: 916KV



**02 HAZET screwdriver socket inner hexagon**

12.5 1/2"

► Technical specifications

- Long version
- IEC 60900:2018
- Drive: square hollow 12.5 mm (1/2 inch)
- Output: Internal hexagonal profile
- protective insulation up to 1000V



MSPX art. No.	Key-width:	Length l1	Ø (d) mm	Length	Manufacturer Item No.:
8000-232-222	4 mm	102 mm	27 mm	156 mm	986LG-4KV
8000-232-239	5 mm	102 mm	27 mm	156 mm	986LG-5KV
8000-232-246	6 mm	102 mm	27 mm	156 mm	986LG-6KV
8000-232-253	8 mm	102 mm	27 mm	156 mm	986LG-8KV
8000-232-215	10 mm	102 mm	27 mm	156 mm	986LG-10KV

**03 HAZET socket spanner insert external hexagon**

12.5 1/2"

► Technical specifications

- short version
- IEC 60900:2018
- Drive: square hollow 12.5 mm (1/2 inch)
- Output: External hexagonal traction profile
- protective insulation up to 1000V



MSPX art. No.	Wrench size (s1)	Length	Ø d1 (at the output)	Ø d2 (at the drive)	depth	Manufacturer Item No.:
8000-232-017	10 mm	54 mm	19.5 mm	27 mm	10.8 mm	900KV-10
8000-232-024	11 mm	54 mm	20.5 mm	27 mm	10.8 mm	900KV-11
8000-232-031	12 mm	54 mm	22 mm	27 mm	11.3 mm	900KV-12
8000-232-048	13 mm	54 mm	23 mm	27 mm	11.3 mm	900KV-13
8000-232-055	14 mm	54 mm	24.5 mm	27 mm	11.8 mm	900KV-14
8000-232-062	15 mm	54 mm	25.5 mm	27 mm	11.8 mm	900KV-15
8000-232-079	16 mm	54 mm	27 mm	27 mm	12.2 mm	900KV-16
8000-232-086	17 mm	54 mm	28 mm	27 mm	12.7 mm	900KV-17
8000-232-093	18 mm	54 mm	29.5 mm	27 mm	14.2 mm	900KV-18
8000-232-109	19 mm	54 mm	30.5 mm	27 mm	14.2 mm	900KV-19
8000-232-116	20 mm	54 mm	32 mm	27 mm	14.2 mm	900KV-20
8000-232-123	22 mm	57.5 mm	34.5 mm	27 mm	17.6 mm	900KV-22
8000-232-130	23 mm	57.5 mm	35.5 mm	27 mm	17.6 mm	900KV-23
8000-232-147	24 mm	60 mm	36.5 mm	27 mm	18.1 mm	900KV-24
8000-232-154	26 mm	60 mm	39 mm	27 mm	17.8 mm	900KV-26
8000-232-161	27 mm	62 mm	40 mm	27 mm	19.7 mm	900KV-27
8000-232-178	30 mm	66 mm	44 mm	27 mm	23.3 mm	900KV-30
8000-232-185	32 mm	66 mm	46.5 mm	27 mm	23 mm	900KV-32

**04 HAZET extension insulated 12,5 mm (1/2 inch)**

12.5 1/2" 12.5 1/2"

► Technical specifications

- With ball lock
- IEC 60900:2018
- Drive: square hollow 12.5 mm (1/2 inch)
- Output: Solid square 12.5 mm (1/2 inch)
- protective insulation up to 1000V



MSPX art. No.	Length	Ø d1 (at the output)	Ø d2 (at the drive)	Manufacturer Item No.:
8000-232-192	140 mm	27 mm	21,5 mm	917KV-5
8000-232-208	264 mm	27 mm	21,5 mm	918KV-10





01  
**HAZET open-end spanner external hexagon**



- Technical specifications
- Slim head
- shaft with extra stable HAZET double-T-profile
- Mouth position: 15
- IEC 60900:2018
- Output: External hexagonal profile
- protective insulation up to 1000V



MSPX art. No.	Key-width:	Head thickness a	Head width b	Length	Manufacturer Item No.:
8000-231-409	7,0 mm	6.2 mm	19.3 mm	88 mm	450KV-7
8000-231-416	8 mm	6.7 mm	20.3 mm	103 mm	450KV-8
8000-231-423	9 mm	6.7 mm	22.9 mm	108 mm	450KV-9
8000-231-256	10 mm	7.2 mm	25.1 mm	113 mm	450KV-10
8000-231-263	11 mm	7.6 mm	27.3 mm	123 mm	450KV-11
8000-231-270	12 mm	7.7 mm	29.2 mm	133 mm	450KV-12
8000-231-287	13 mm	8.5 mm	31.1 mm	143 mm	450KV-13
8000-231-294	14 mm	8.7 mm	32.9 mm	153 mm	450KV-14
8000-231-300	15 mm	10.4 mm	35.8 mm	166 mm	450KV-15
8000-231-317	16 mm	10.4 mm	37.9 mm	171 mm	450KV-16
8000-231-324	17 mm	10.9 mm	39.8 mm	171 mm	450KV-17
8000-231-331	18 mm	11.4 mm	41.8 mm	181 mm	450KV-18
8000-231-348	19 mm	11.4 mm	43.8 mm	186 mm	450KV-19
8000-231-355	22 mm	11.9 mm	50 mm	211 mm	450KV-22
8000-231-362	24 mm	13.3 mm	54.3 mm	238 mm	450KV-24
8000-231-379	27 mm	13.6 mm	60.2 mm	258 mm	450KV-27
8000-231-386	30 mm	14.6 mm	66.7 mm	278 mm	450KV-30
8000-231-393	32 mm	14.6 mm	70 mm	298 mm	450KV-32



02  
**HAZET Single ended ring spanner external double hex**



- Technical specifications
- Deep cranked
- Heads thin-walled
- IEC 60900:2018
- Output: External double hexagonal profile
- protective insulation up to 1000V



MSPX art. No.	Key-width:	Head thickness a	Head width b	Length	Offset (height)	Manufacturer Item No.:
8000-231-584	7 mm	6.4 mm	13.6 mm	152 mm	15.5 mm	630KV-7
8000-231-591	8 mm	6.8 mm	13.8 mm	164 mm	18 mm	630KV-8
8000-231-607	9 mm	7.3 mm	15.5 mm	164 mm	18 mm	630KV-9
8000-231-430	10 mm	7.6 mm	17.5 mm	172 mm	20.5 mm	630KV-10
8000-231-447	11 mm	8.7 mm	19,0 mm	178 mm	20.5 mm	630KV-11
8000-231-454	12 mm	8.7 mm	20.5 mm	193 mm	22 mm	630KV-12
8000-231-461	13 mm	9.3 mm	22 mm	198 mm	22 mm	630KV-13
8000-231-478	14 mm	10 mm	23.5 mm	209 mm	23.5 mm	630KV-14
8000-231-485	15 mm	11 mm	24 mm	214 mm	24 mm	630KV-15
8000-231-492	16 mm	11 mm	27.5 mm	217 mm	26.5 mm	630KV-16
8000-231-508	17 mm	11 mm	27.5 mm	223 mm	26.5 mm	630KV-17
8000-231-515	18 mm	11.5 mm	30 mm	234 mm	28.5 mm	630KV-18
8000-231-522	19 mm	11.5 mm	31 mm	234 mm	28.5 mm	630KV-19
8000-231-539	22 mm	13 mm	35.5 mm	263 mm	30 mm	630KV-22
8000-231-546	24 mm	13 mm	38 mm	280 mm	31 mm	630KV-24
8000-231-553	27 mm	14 mm	42 mm	295 mm	32 mm	630KV-27
8000-231-560	30 mm	16 mm	46 mm	305 mm	33 mm	630KV-30
8000-231-577	32 mm	16 mm	48 mm	312 mm	34 mm	630KV-32



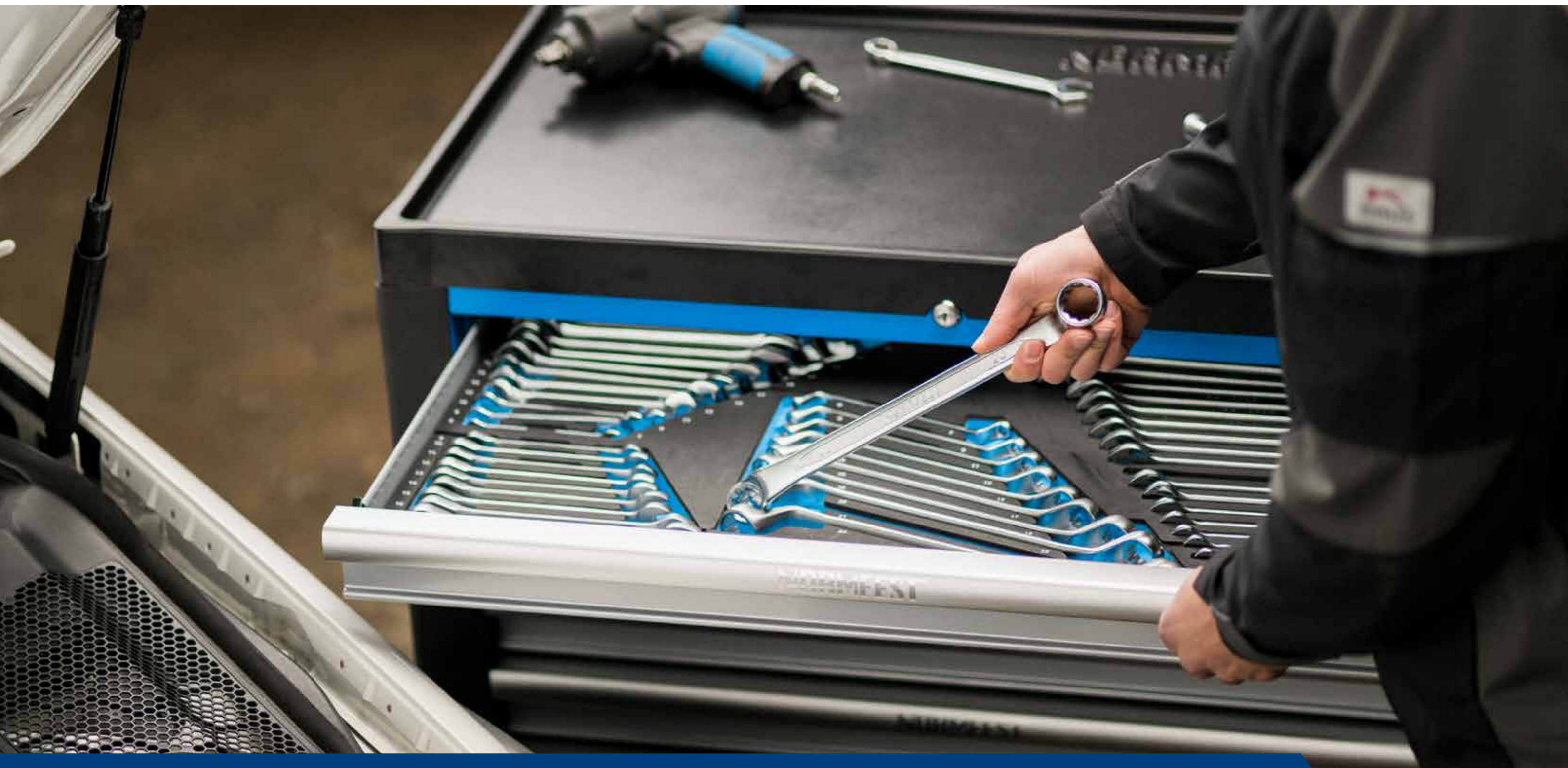





workshop trolley

# Workshop trolleys at a glance:



Workshop trolley standard

Matching foam inlets: **S, M, L**



ECO workshop trolley



Workshop trolley XL

Matching foam inlets: **S, M, L, XL**



Service trolley

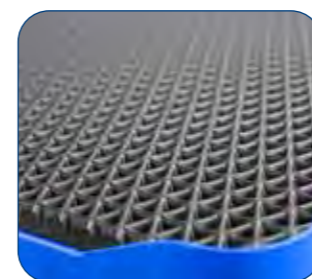



# Set 1

### Screwdriver set

12 pieces, drawer size M

► Item no. [7716-000-011](#)



### Set of pliers

4-part, drawer size M

► Item no. [7716-000-019](#)



Drawer 1



the beginner

### 1/4", 3/8", 1/2" socket wrench set

122-part drawer size L

► Item no. [7716-000-002](#)



Drawer 2

### Key phrase

37-part drawer size L

► Item no. [7716-000-001](#)



Drawer 3



### ECO workshop trolley

► Item no. [7716-910-1](#) - blau

or

► Item no. [7716-910-2](#) - for 1001-179-6



## Set 2

**Workshop trolley standard**

▶ Item no. [7716-920-1](#) - blue

or

▶ Item no. [7716-920-2](#) - for 1001-179-6

**Screwdriver set**

12 pieces, drawer size M

▶ Item no. [7716-000-011](#)

**Set of pliers**

4-part, drawer size M

▶ Item no. [7716-000-019](#)



Drawer 1

**1/4", 3/8", 1/2" socket wrench set**

122-part drawer size L

▶ Item no. [7716-000-002](#)



Drawer 2

**1/2" TORX® socket wrench insert**

26 pieces, drawer size M

▶ Item no. [7716-000-016](#)



Drawer 3

**1/2" INBUS socket set**

24 pieces, drawer size M

▶ Item no. [7716-000-023](#)

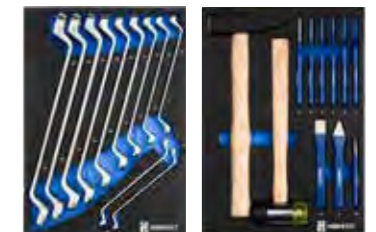

Drawer 4

**Hammer, chisel and pin punch set**

11 pieces, drawer size M

▶ Item no. [7716-000-022](#)

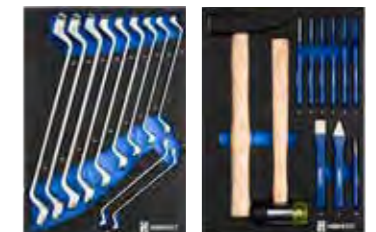
**Double ring spanner set**

11 pieces, drawer size M

▶ Item no. [7716-000-009](#)



Drawer 5

**Ratchet combination wrench set**

44-part drawer size L

▶ Item no. [7716-000-017](#)



Drawer 6

**T- / L-handle screwdriver set**

16 pieces, drawer size L

▶ Item no. [7716-000-024](#)



**Screwdriver set**▶ Item no. [7716-000-011](#)**Set of pliers**▶ Item no. [7716-000-019](#)**Schaumstoffinlett**▶ Item no. [7716-050-024](#)

Drawer 1

**1/4", 3/8", 1/2" socket wrench set**

122-part drawer size L

▶ Item no. [7716-000-002](#)

Drawer 2

**Impact nuts**

5-piece, drawer size S

▶ Item no. [7716-000-026](#)

Drawer 3

**1/2" TORX® socket wrench insert**▶ Item no. [7716-000-016](#)**Maul Ring Ratchet Set 15° 8-15mm**▶ Item no. [7716-000-028](#)**1/4", 3/8", 1/2" Anti Slip Nuts Set**▶ Item no. [7716-000-030](#)**Hammer, chisel and pin punch set**▶ Item no. [7716-000-022](#)

Drawer 4

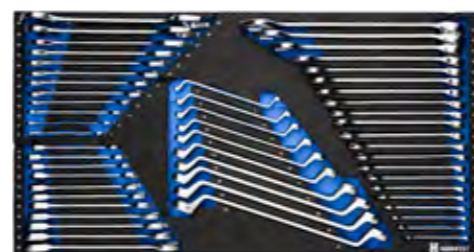
**1/2" INBUS socket set**▶ Item no. [7716-000-023](#)**Maul ring ratchet set 15° 16-22mm**▶ Item no. [7716-000-029](#)

Drawer 5

**Combination wrench set**

54 pieces, drawer size XL

▶ Item no. [7716-000-003](#)**T- / L-handle screwdriver set**

16 pieces, drawer size L

▶ Item no. [7716-000-024](#)

Drawer 6

**Files set**

5-teilig Schubladengröße S

▶ Item no. [7716-000-027](#)

Set 3

all in one

+

**Workshop trolley XL**▶ Item no. [7716-930-1](#) - blau

or

▶ Item no. [7716-930-2](#) - for 1001-179-6





3

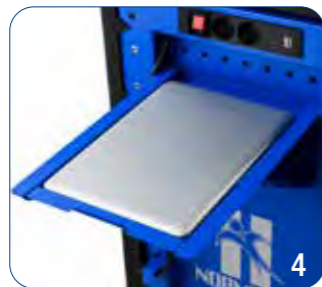

4



6



2



01

**Workshop trolley XL**

- ▶ Item no. [7716-930-1](#) - blau
- ▶ Item no. [7716-930-2](#) - for 1001-179-6

## ▶ Product description

- incl. edge protection
- plastic top with 4 shelves
- maximum weight per drawer: 45 kg
- maximum total load: 700 kg
- 8 drawers (7 small & 1 large)
- material thickness: 1mm
- total length: 899mm
- total height with castors: 1002mm
- total depth: 495mm
- Drawer thickness: 0.8mm
- Drawer dimensions small:
  - Width: 753mm
  - Depth: 397mm
  - Height: 75mm
- Drawer dimensions large:
  - Width: 753mm
  - Depth: 397mm
  - Height: 150mm
- Mutual pull-out stop for minimum risk of tipping over
- Central locking with cylinder lock
- Anodised aluminium handles with standard logo
- Lockable incl. 2 keys
- with quick release system
- Empty weight: 91 kg
- Scope of delivery:
  - Operating instructions
  - Can holder blue (7716-950-003)
  - Handle NF (7716-950-009)
  - 2x castor workshop trolley fixed (7716-950-010)
  - 2x castor workshop trolley steerable (7716-950-011)
  - Socket strip blue with USB charging possibility (7716-950-024)

02

**Can holder**

- ▶ Item no. [7716-950-003](#) - blau
- ▶ Item no. [7716-950-004](#) - for 1001-179-6

03

**Paper holder**

- ▶ Item no. [7716-950-005](#) - blau
- ▶ Item no. [7716-950-006](#) - for 1001-179-6

04

**Laptop holder**

- ▶ Item no. [7716-950-007](#) - blau
- ▶ Item no. [7716-950-008](#) - for 1001-179-6

05

**Washing brush angled 30**

- ▶ Item no. [7716-950-009](#)

06

**Can holder**

- ▶ Item no. [7716-950-010](#) - fixed
- ▶ Item no. [7716-950-011](#) - flexible

07

**suitable for workshop trolley XXL (art. no. 7716-930-1 and -2)**

- ▶ Item no. [7716-950-014](#)

08

**Replacement lock**

- ▶ Item no. [7716-950-015](#)

09

**Drawer**

- ▶ Item no. [7716-950-020](#) - small
- ▶ Item no. [7716-950-021](#) - Output: Slot profile

Weight: 305 g

10

**Plastic lid**

- ▶ Item no. [7716-950-023](#)

**You will find an overview of suitable tool assortments on the next double page.**

*Illustrations may differ from the original.*

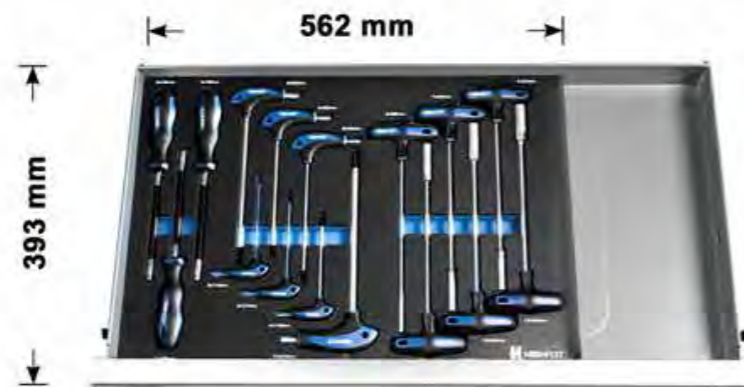
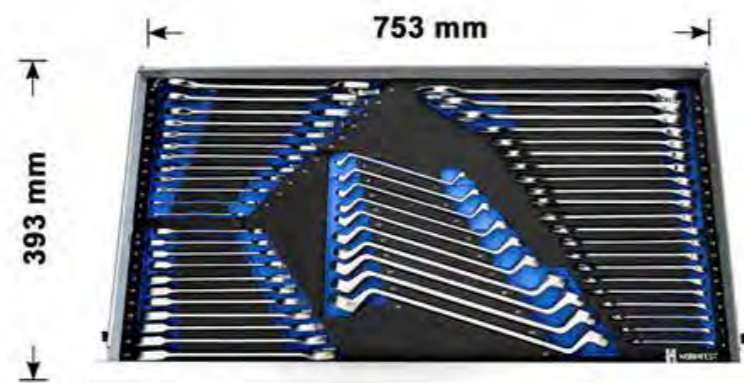

**S****M****L****XL**

01

**Accessories for workshop trolley XL**

- ▶ Item no. [7716-930-1](#) - blau
- ▶ Item no. [7716-930-2](#) - for 1001-179-6

**Matching foam inlet set:****S**

- ▶ Item no. [7716-050-024](#) - Foam inlay 3-part, 190x395x30mm
- ▶ Item no. [7716-000-025](#) - Set of gripping pliers 3-piece, drawer size S
- ▶ Item no. [7716-000-026](#) - Impact nuts 5-piece, drawer size S
- ▶ Item no. [7716-000-027](#) - Files set 5-piece, drawer size S
- ▶ Item no. [7716-000-028](#) - Maul Ring Ratchet Set 15° 8-15mm 6-piece, drawer size S
- ▶ Item no. [7716-000-029](#) - Maul ring ratchet set 15° 16-22mm 6-piece, drawer size S

**M**

- ▶ Item no. [7716-000-004](#) - 1/2 „hexagon socket wrench set 25 pieces, drawer size M
- ▶ Item no. [7716-000-005](#) - 1/4 „socket wrench set 68 pieces, drawer size M
- ▶ Item no. [7716-000-006](#) - 3/8 „socket wrench set 62 pieces, drawer size M
- ▶ Item no. [7716-000-007](#) - 1/4 „, 3/8“, 1/2 „socket wrench set, long 23 pieces, drawer size M
- ▶ Item no. [7716-000-008](#) - Double open-end wrench set 12 pieces, drawer size M
- ▶ Item no. [7716-000-009](#) - Double ring spanner set 11 pieces, drawer size M
- ▶ Item no. [7716-000-010](#) - Combination wrench set 17 pieces, drawer size M
- ▶ Item no. [7716-000-011](#) - Screwdriver set 12 pieces, drawer size M
- ▶ Item no. [7716-000-012](#) - Safety pliers set 6 parts, drawer size M
- ▶ Item no. [7716-000-013](#) - Impact screwdriver set 7 pieces, drawer size M
- ▶ Item no. [7716-000-014](#) - Articulated ratchet combination wrench set 13 pieces, drawer size M
- ▶ Item no. [7716-000-015](#) - 1/2 „XZN socket wrench set 22 pieces, drawer size M
- ▶ Item no. [7716-000-016](#) - 1/2 „TORX® socket wrench insert 26 pieces, drawer size M
- ▶ Item no. [7716-000-019](#) - Set of pliers 4-part, drawer size M
- ▶ Item no. [7716-000-021](#) - TORX screwdriver set 11 pieces, drawer size M
- ▶ Item no. [7716-000-022](#) - Hammer, chisel and pin punch set 11 pieces, drawer size M
- ▶ Item no. [7716-000-023](#) - 1/2 „INBUS socket set 24 pieces, drawer size M
- ▶ Item no. [7716-000-030](#) - 1/4“, 3/8“, 1/2“ Anti Slip Nuts Set 53-piece, drawer size M

**L**

- ▶ Item no. [7716-000-001](#) - Key phrase 37-part drawer size L
- ▶ Item no. [7716-000-002](#) - 1/4 „, 3/8“, 1/2 „socket wrench set 122-part drawer size L
- ▶ Item no. [7716-000-017](#) - Ratchet combination wrench set 44-part drawer size L
- ▶ Item no. [7716-000-018](#) - 3/4 „socket wrench set 20 pieces, drawer size L
- ▶ Item no. [7716-000-024](#) - T- / L-handle screwdriver set 16 pieces, drawer size L

**XL**

- ▶ Item no. [7716-000-003](#) - Combination wrench set 54 pieces, drawer size XL





3

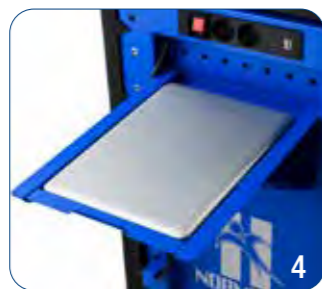

4



6



2



11

01

**Workshop trolley standard**

- ▶ Item no. [7716-920-1](#) - blau
- ▶ Item no. [7716-920-2](#) - for 1001-179-6

## ▶ Product description

- incl. edge protection
- plastic top with 4 shelves
- maximum weight per drawer: 45 kg
- maximum total load: 700 kg
- material thickness: 1mm
- total length: 715mm
- total height with castors: 1002mm
- total depth: 495mm
- 8 drawers (7 small & 1 large)
- Drawer thickness: 0.8mm
- Drawer dimensions small:
  - Width: 569mm
  - Depth: 397mm
  - Height: 75mm
- Drawer dimensions large:
  - Width: 569mm
  - Depth: 397mm
  - Height: 150mm
- Mutual pull-out stop for minimum risk of tipping over
- Central locking with cylinder lock
- Anodised aluminium handles with standard logo
- Lockable incl. 2 keys
- with quick release system
- Empty weight: 80 kg
- Scope of delivery:
  - Operating instructions
  - Can holder blue/black (7716-950-003/-004)
  - Handle NF (7716-950-009)
  - 2x castor workshop trolley fixed (7716-950-010)
  - 2x castor workshop trolley steerable (7716-950-011)

02

**Can holder**

- ▶ Item no. [7716-950-003](#) - blau
- ▶ Item no. [7716-950-004](#) - for 1001-179-6

03

**Paper holder**

- ▶ Item no. [7716-950-005](#) - blau
- ▶ Item no. [7716-950-006](#) - for 1001-179-6

04

**Laptop holder**

- ▶ Item no. [7716-950-007](#) - blau
- ▶ Item no. [7716-950-008](#) - for 1001-179-6

05

**Washing brush angled 30**

- ▶ Item no. [7716-950-009](#)

06

**Can holder**

- ▶ Item no. [7716-950-010](#) - fixed
- ▶ Item no. [7716-950-011](#) - flexible

07

**Perforated wall**

- ▶ Item no. [7716-950-012](#) - blau
- ▶ Item no. [7716-950-013](#) - for 1001-179-6

08

**Replacement lock**

- ▶ Item no. [7716-950-015](#)

09

**Drawer**

- ▶ Item no. [7716-950-018](#) - small
- ▶ Item no. [7716-950-019](#) - large

10

**Plastic lid**

- ▶ Item no. [7716-950-022](#)

11

**Power strip**

- ▶ Item no. [7716-950-024](#) - blau
- ▶ Item no. [7716-950-025](#) - Black

**You will find an overview of suitable tool assortments on the next double page.**

*Illustrations may differ from the original.*

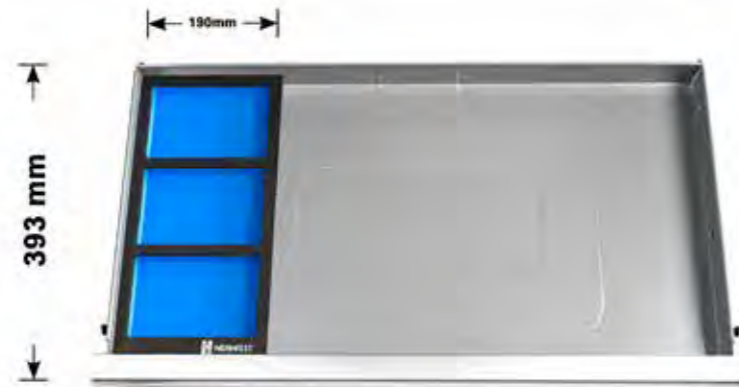
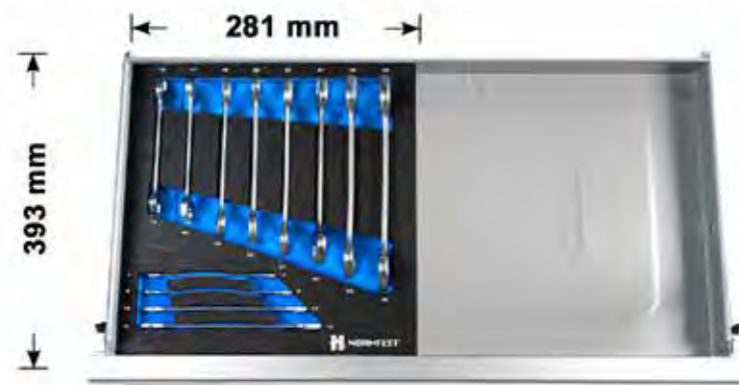
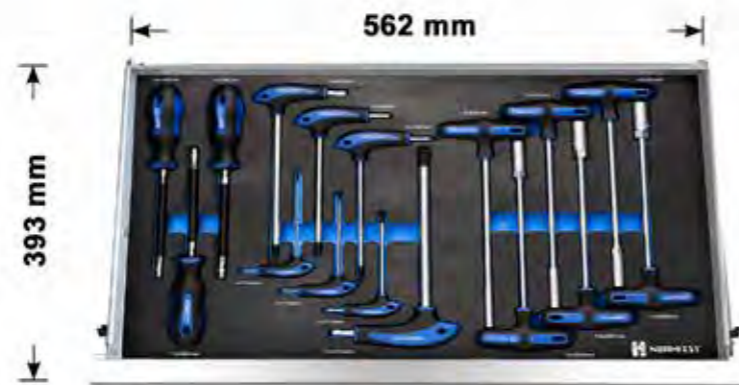

**S****M****L**

01

### Accessories for workshop trolley Standard- Workshop trolley standard

- ▶ Item no. [7716-920-1](#) - blau
- ▶ Item no. [7716-920-2](#) - for 1001-179-6



#### Matching foam inlet set:

**S**

- ▶ Item no. [7716-050-024](#) - Foam inlay 3-part, 190x395x30mm
- ▶ Item no. [7716-000-025](#) - Set of gripping pliers 3-piece, drawer size S
- ▶ Item no. [7716-000-026](#) - Impact nuts 5-piece, drawer size S
- ▶ Item no. [7716-000-027](#) - Files set 5-piece, drawer size S
- ▶ Item no. [7716-000-028](#) - Maul Ring Ratchet Set 15° 8-15mm 6-piece, drawer size S
- ▶ Item no. [7716-000-029](#) - Maul ring ratchet set 15° 16-22mm 6-piece, drawer size S

**M**

- ▶ Item no. [7716-000-004](#) - 1/2 „hexagon socket wrench set 25 pieces, drawer size M
- ▶ Item no. [7716-000-005](#) - 1/4 „socket wrench set 68 pieces, drawer size M
- ▶ Item no. [7716-000-006](#) - 3/8 „socket wrench set 62 pieces, drawer size M
- ▶ Item no. [7716-000-007](#) - 1/4 „, 3/8“, 1/2 „socket wrench set, long 23 pieces, drawer size M
- ▶ Item no. [7716-000-008](#) - Double open-end wrench set 12 pieces, drawer size M
- ▶ Item no. [7716-000-009](#) - Double ring spanner set 11 pieces, drawer size M
- ▶ Item no. [7716-000-010](#) - Combination wrench set 17 pieces, drawer size M
- ▶ Item no. [7716-000-011](#) - Screwdriver set 12 pieces, drawer size M
- ▶ Item no. [7716-000-012](#) - Safety pliers set 6 parts, drawer size M
- ▶ Item no. [7716-000-013](#) - Impact screwdriver set 7 pieces, drawer size M
- ▶ Item no. [7716-000-014](#) - Articulated ratchet combination wrench set 13 pieces, drawer size M
- ▶ Item no. [7716-000-015](#) - 1/2 „XZN socket wrench set 22 pieces, drawer size M
- ▶ Item no. [7716-000-016](#) - 1/2 „TORX® socket wrench insert 26 pieces, drawer size M
- ▶ Item no. [7716-000-019](#) - Set of pliers 4-part, drawer size M
- ▶ Item no. [7716-000-021](#) - TORX screwdriver set 11 pieces, drawer size M
- ▶ Item no. [7716-000-022](#) - Hammer, chisel and pin punch set 11 pieces, drawer size M
- ▶ Item no. [7716-000-023](#) - 1/2 „INBUS socket set 24 pieces, drawer size M
- ▶ Item no. [7716-000-030](#) - 1/4“, 3/8“, 1/2“ Anti Slip Nuts Set 53-piece, drawer size M

**L**

- ▶ Item no. [7716-000-001](#) - Key phrase 37-part drawer size L
- ▶ Item no. [7716-000-002](#) - 1/4 „, 3/8“, 1/2 „socket wrench set 122-part drawer size L
- ▶ Item no. [7716-000-017](#) - Ratchet combination wrench set 44-part drawer size L
- ▶ Item no. [7716-000-018](#) - 3/4 „socket wrench set 20 pieces, drawer size L
- ▶ Item no. [7716-000-024](#) - T- / L-handle screwdriver set 16 pieces, drawer size L



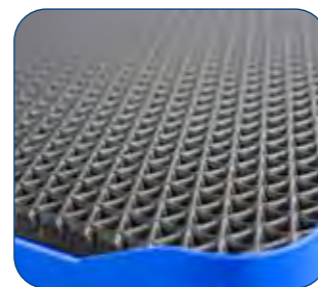
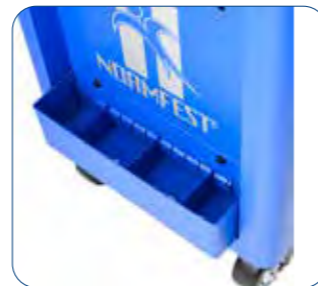

01

**ECO workshop trolley**

- ▶ Item no. [7716-910-1](#) - blau
- ▶ Item no. [7716-910-2](#) - for 1001-179-6

## ▶ Product description

- Maximum weight per drawer: 45 kg
- Mutual pull-out stop for minimum risk of tipping over
- Maximum total load: 700 kg
- material thickness: 1mm
- 8 drawers (7 small & 1 large)
- drawer thickness: 0.8mm
- Drawer dimensions small:
  - Width: 569mm
  - Depth: 397mm
  - Height: 75mm
- Drawer dimensions large:
  - Width: 569mm
  - Depth: 397mm
  - Height: 150mm
- Total length: 725mm
- Total height: 1002mm
- Total depth: 459mm
- Empty weight: 71 kg
- Scope of delivery:
  - Operating instructions
  - Can holder blue/black (7716-950-001/-002)
  - Handle NF (7716-950-009)
  - 2x castor workshop trolley fixed (7716-950-010)
  - 2x roll workshop trolley flexible (7716-950-011)
- Foam top

02

**Can holder**

- ▶ Item no. [7716-950-001](#) - blau
- ▶ Item no. [7716-950-002](#) - for 1001-179-6

03

**Paper holder**

- ▶ Item no. [7716-950-005](#) - blau
- ▶ Item no. [7716-950-006](#) - for 1001-179-6

04

**Laptop holder**

- ▶ Item no. [7716-950-007](#) - blau
- ▶ Item no. [7716-950-008](#) - for 1001-179-6

05

**Washing brush angled 30**

- ▶ Item no. [7716-950-009](#)

06

**Can holder**

- ▶ Item no. [7716-950-010](#) - fixed
- ▶ Item no. [7716-950-011](#) - flexible

07

**Perforated wall**

- ▶ Item no. [7716-950-012](#) - blau
- ▶ Item no. [7716-950-013](#) - for 1001-179-6

08

**Replacement lock**

- ▶ Item no. [7716-950-015](#)

09

**Drawer**

- ▶ Item no. [7716-950-016](#) - small
- ▶ Item no. [7716-950-017](#) - large

Illustrations may differ from the original.





01

**Service trolley**

- ▶ Item no. [7716-940-1](#) - [blue](#)
- ▶ Item no. [7716-940-2](#) - [for 1001-179-6](#)

▶ **Product description**

- Dimensions including rollers (WxDxH): 702 x 491 x 832 mm
- Dimensions without castors: (WxDxH): 702 x 491 x 70 mm
- Dimensions upper middle shelf (WxDxH): 678 x 463 x 58 mm
- Dimensions lower shelf (WxDxH): 678 x 398 x 55 mm
- middle shelf adjustable in height
- upper shelf with removable foam insert
- Material: 1.0 mm steel thickness
- with side handle
- with can holder
- 4 rubber rollers (2 fixed rollers and 2 swiveling rollers with brakes)
- Weight: 21.3 kg
- Total load capacity: 120 kg
- Load capacity per shelf: 40 kg



*Illustrations may differ from the original.*



# The right tool set for every job!

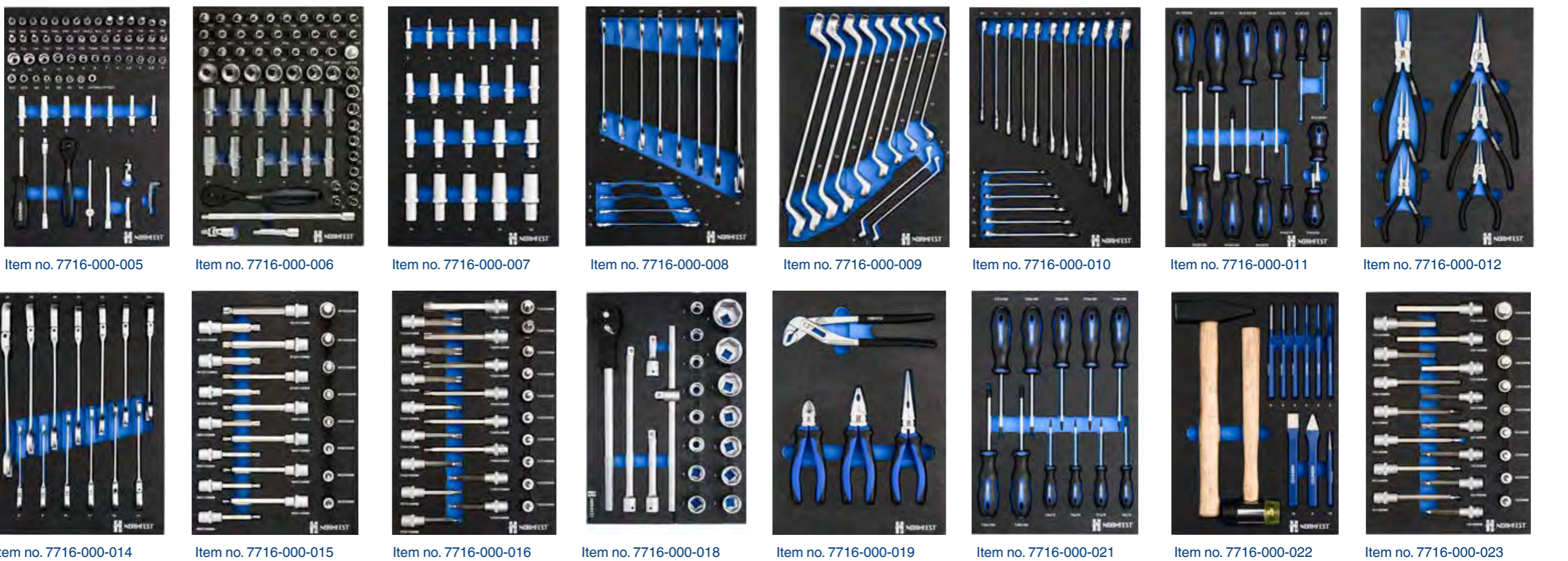
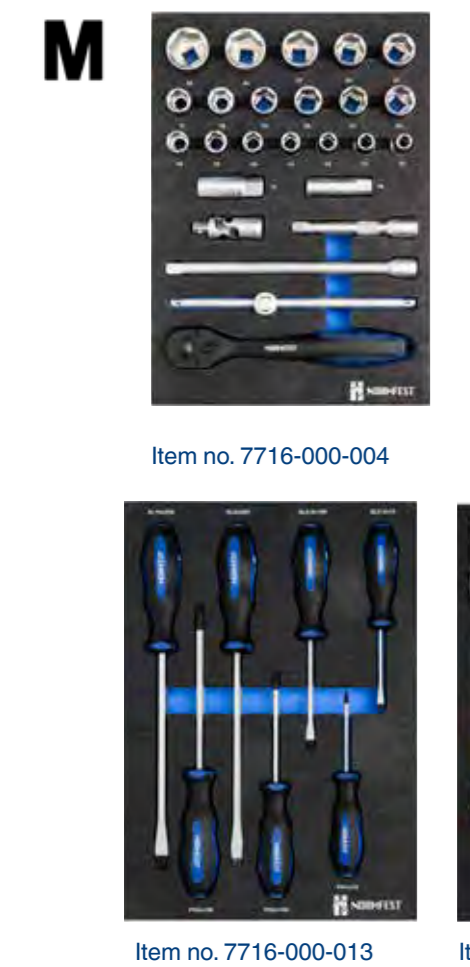
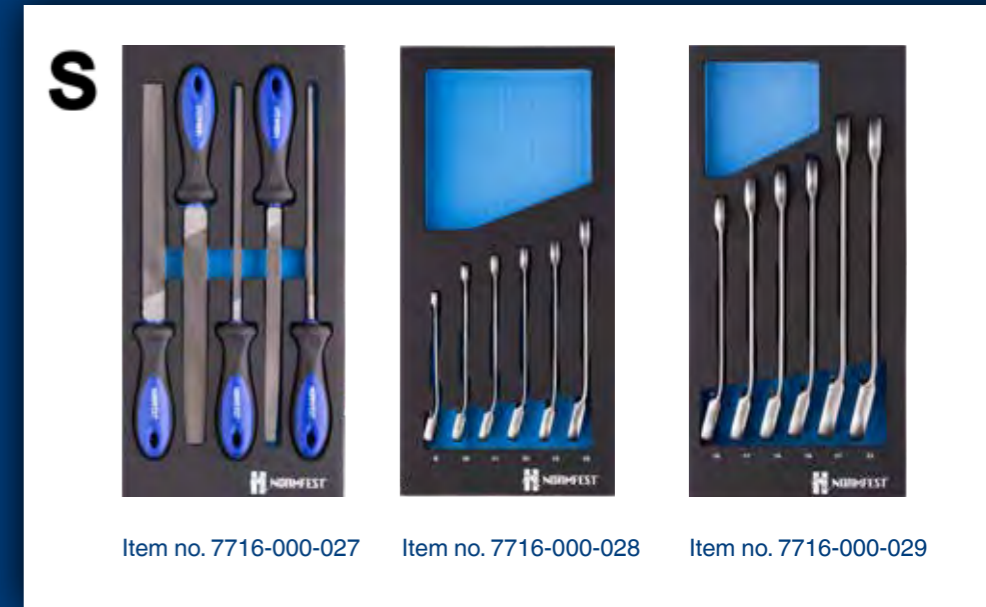
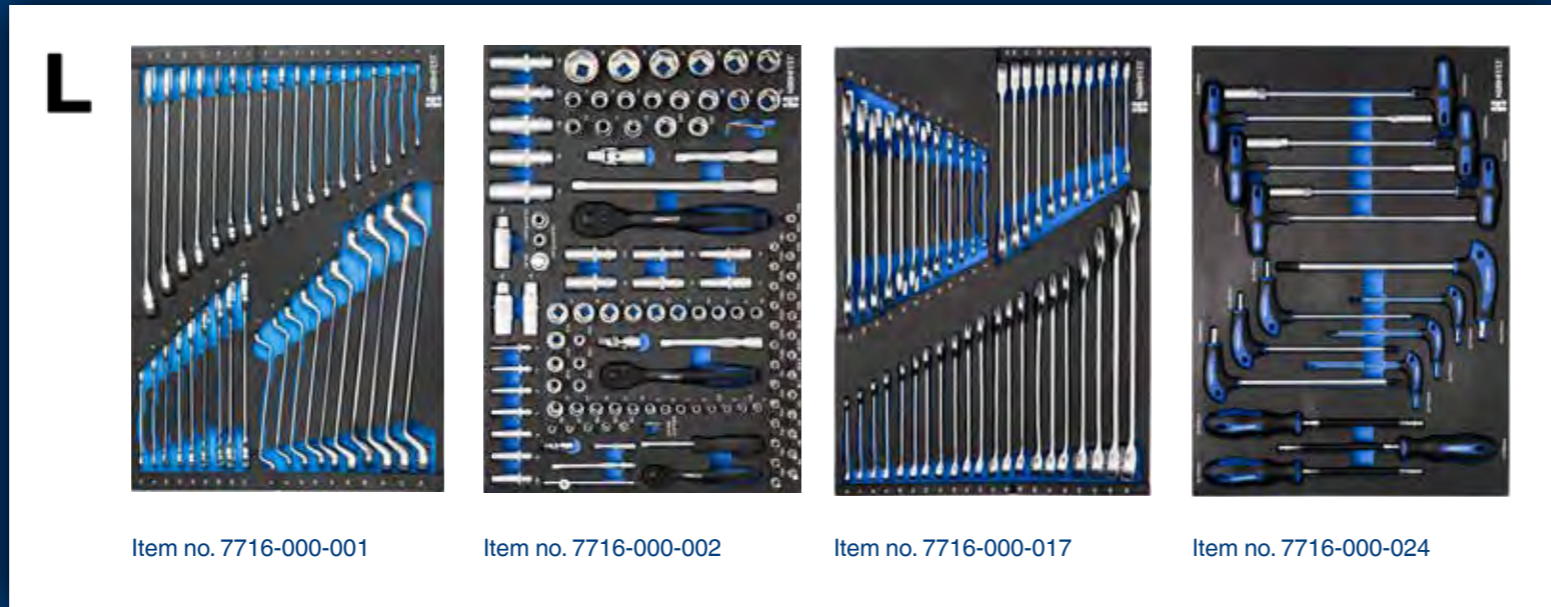



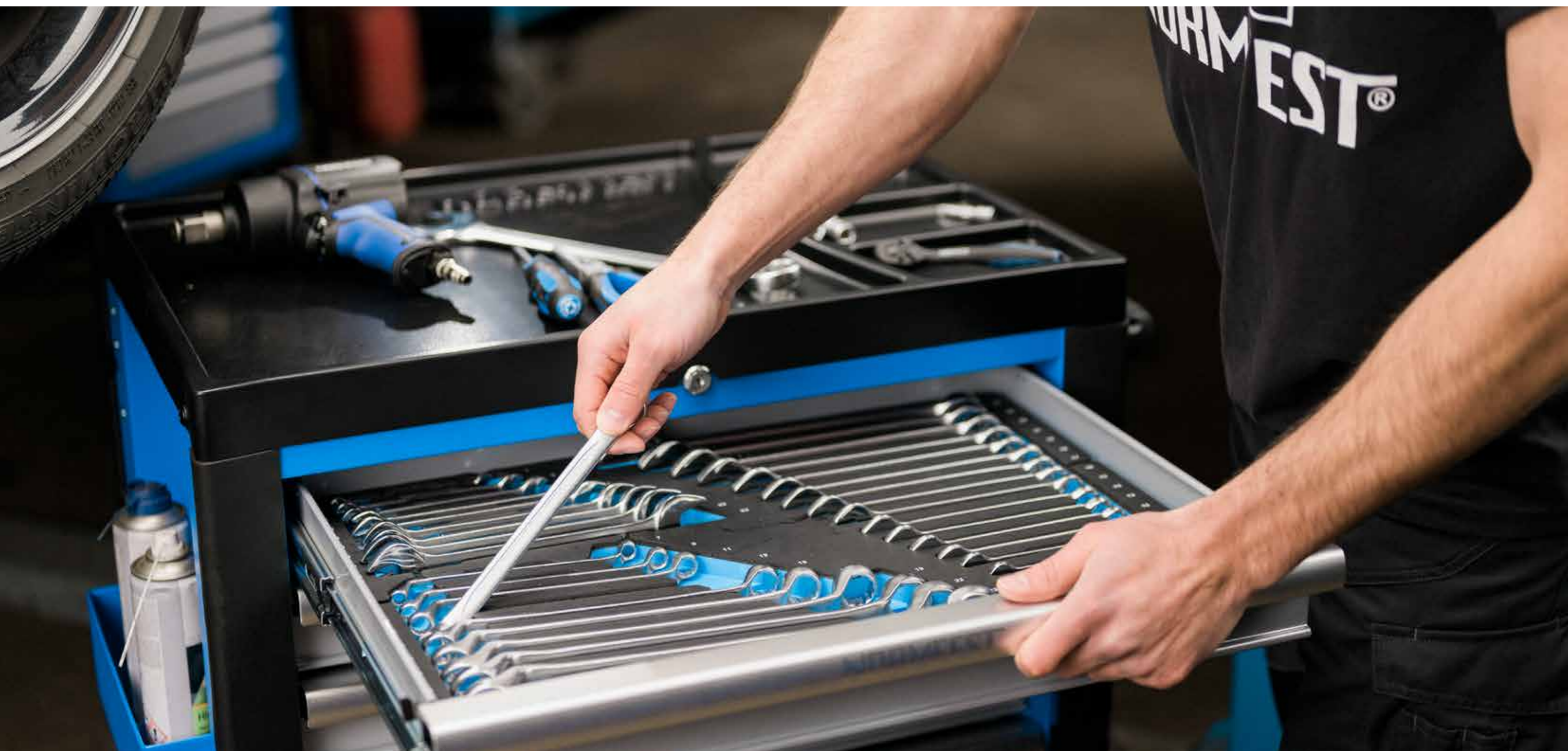

Pliers for retaining rings



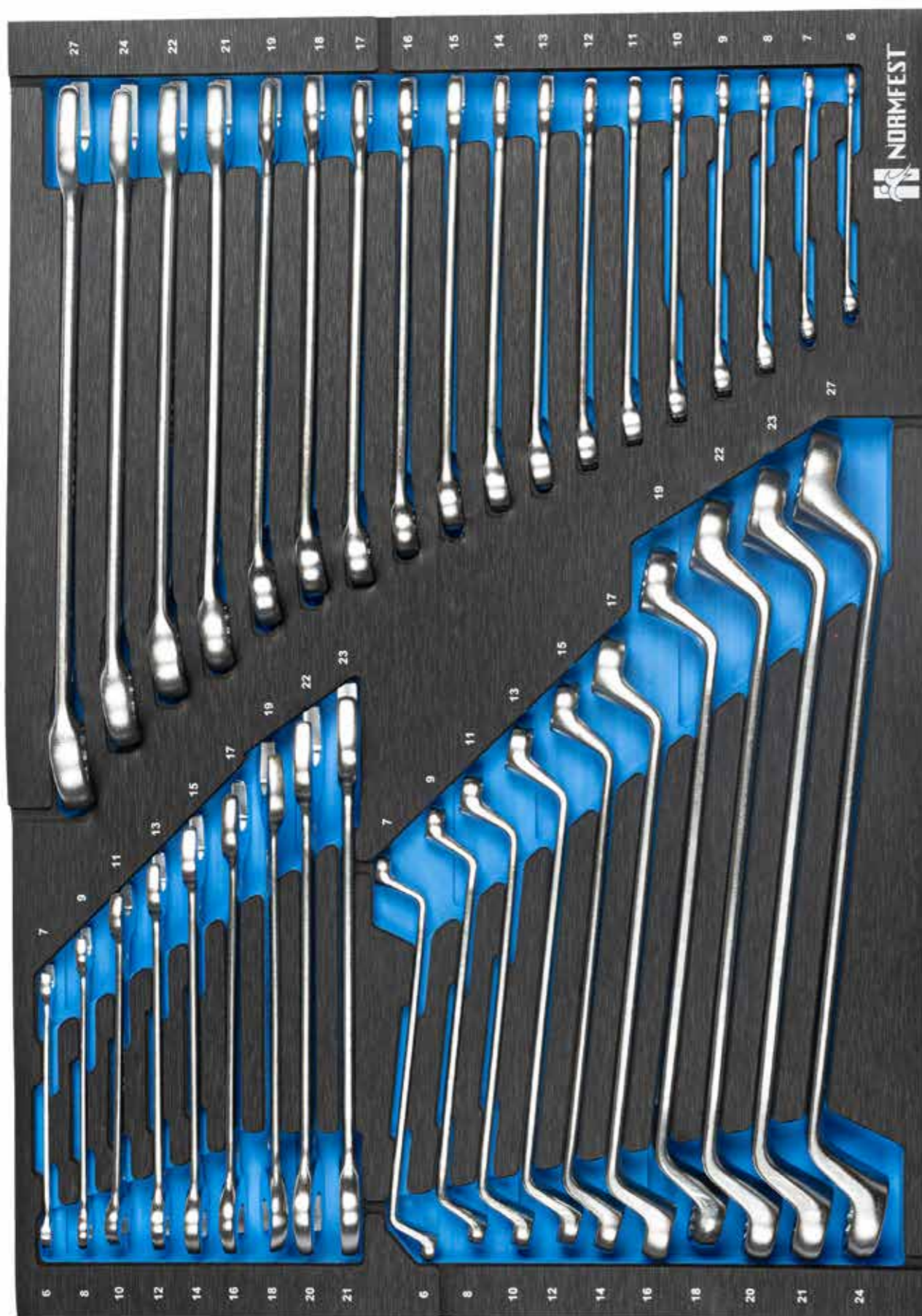

01

**Key phrase**

37-part drawer size L

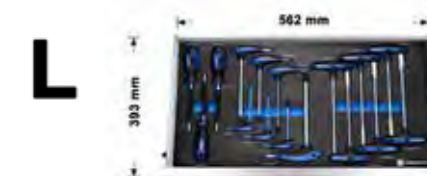
▶ Item no. [7716-000-001](#)

The set consists of:

▶ **1" Sliding piece**

Item No.	length
7716-300-6	105 mm
7716-300-7	115 mm
7716-300-8	125 mm
7716-300-9	135 mm
7716-300-10	145 mm
7716-300-11	155 mm
7716-300-12	165 mm
7716-300-13	175 mm
7716-300-14	185 mm
7716-300-15	195 mm
7716-300-16	205 mm
7716-300-17	215 mm
7716-300-18	225 mm
7716-300-19	230 mm
7716-300-20	245 mm
7716-300-21	285 mm
7716-300-24	285 mm
7716-300-27	310 mm

▶ **1" reversible ratchet**

Item No.	length
7716-206-7	125 mm
7716-208-9	140 mm
7716-210-11	155 mm
7716-212-13	170 mm
7716-214-15	185 mm
7716-216-17	205 mm
7716-218-19	215 mm
7716-220-22	230 mm
7716-221-23	240 mm

▶ **box wrench socket**

Item No.	length
7716-106-7	175 mm
7716-108-9	190 mm
7716-110-11	205 mm
7716-112-13	220 mm
7716-114-15	245 mm
7716-116-17	270 mm
7716-118-19	295 mm
7716-120-22	315 mm
7716-121-23	340 mm
7716-124-27	350 mm

*Illustrations may differ from the original.*



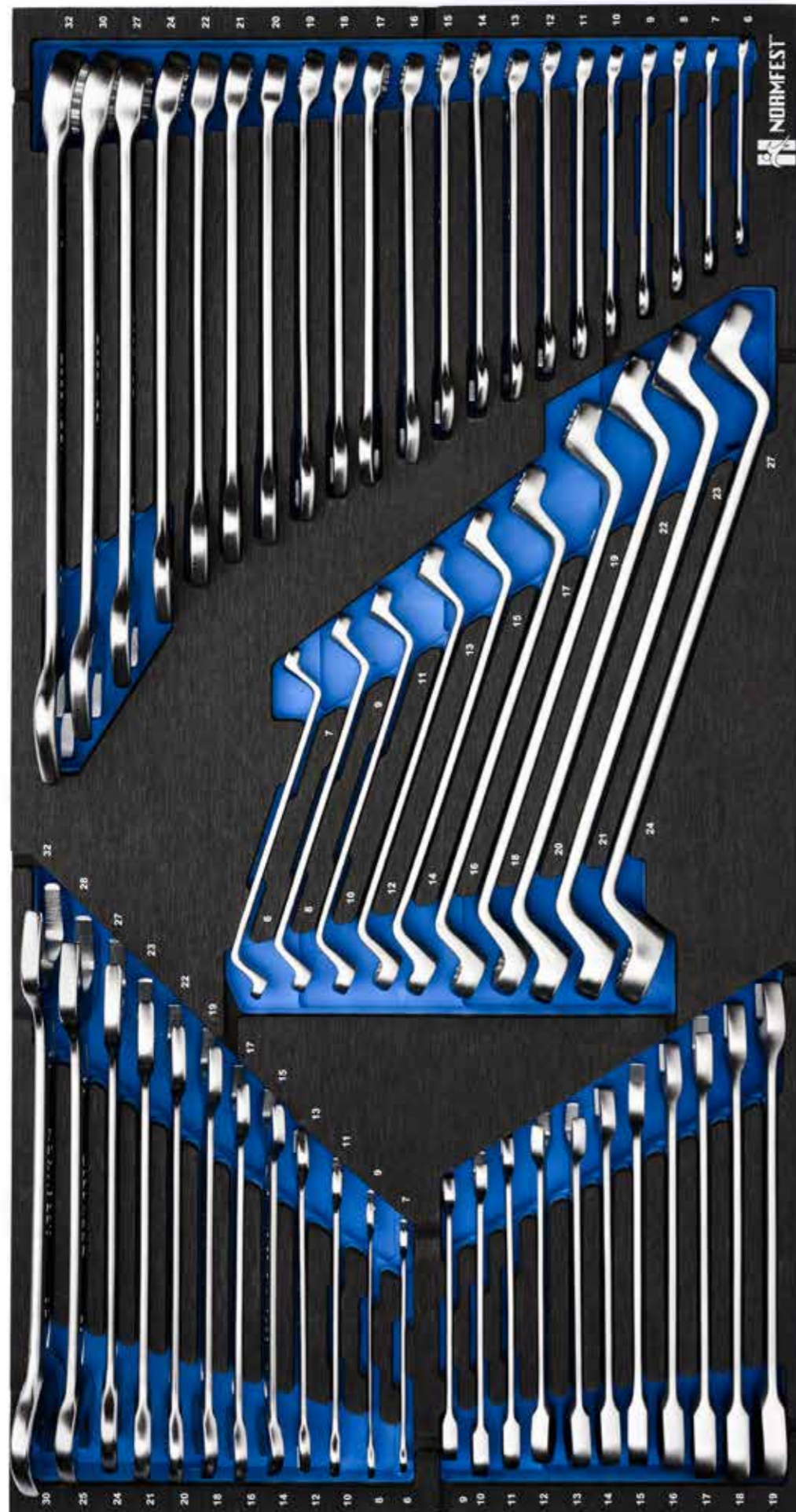

Illustrations may differ from the original.

01

### Combination wrench set

54 pieces, drawer size XL

► Item no. [7716-000-003](#)

The set consists of:

#### ► 1" Sliding piece

\*\*\*???\* AGTB Standard:3

#### ► Ratchet combination spanner without joint

Item No.	length
7716-400-9	140 mm
7716-400-10	160 mm
7716-400-11	170 mm
7716-400-12	175 mm
7716-400-13	180 mm
7716-400-14	185 mm
7716-400-15	200 mm
7716-400-16	230 mm
7716-400-17	225 mm
7716-400-18	235 mm
7716-400-19	245 mm



#### ► 1" reversible ratchet

Item No.	length
7716-206-7	125 mm
7716-208-9	140 mm
7716-210-11	155 mm
7716-212-13	170 mm
7716-214-15	185 mm
7716-216-17	205 mm
7716-218-19	215 mm
7716-220-22	230 mm
7716-221-23	240 mm
7716-224-27	255 mm
7716-225-28	280 mm
7716-230-32	290 mm

#### ► box wrench socket

Item No.	length
7716-106-7	175 mm
7716-108-9	190 mm
7716-110-11	205 mm
7716-112-13	220 mm
7716-114-15	245 mm
7716-116-17	270 mm
7716-118-19	295 mm
7716-120-22	315 mm
7716-121-23	340 mm
7716-124-27	350 mm





01  
**Double open-end wrench set**  
 12 pieces, drawer size M

► Item no. [7716-000-008](#)

The set consists of:

► **1" reversible ratchet**

Item No.	length
7716-206-7	125 mm
7716-208-9	140 mm
7716-210-11	155 mm
7716-212-13	170 mm
7716-214-15	185 mm
7716-216-17	205 mm
7716-218-19	215 mm
7716-220-22	230 mm
7716-221-23	240 mm
7716-224-27	255 mm
7716-225-28	280 mm
7716-230-32	290 mm

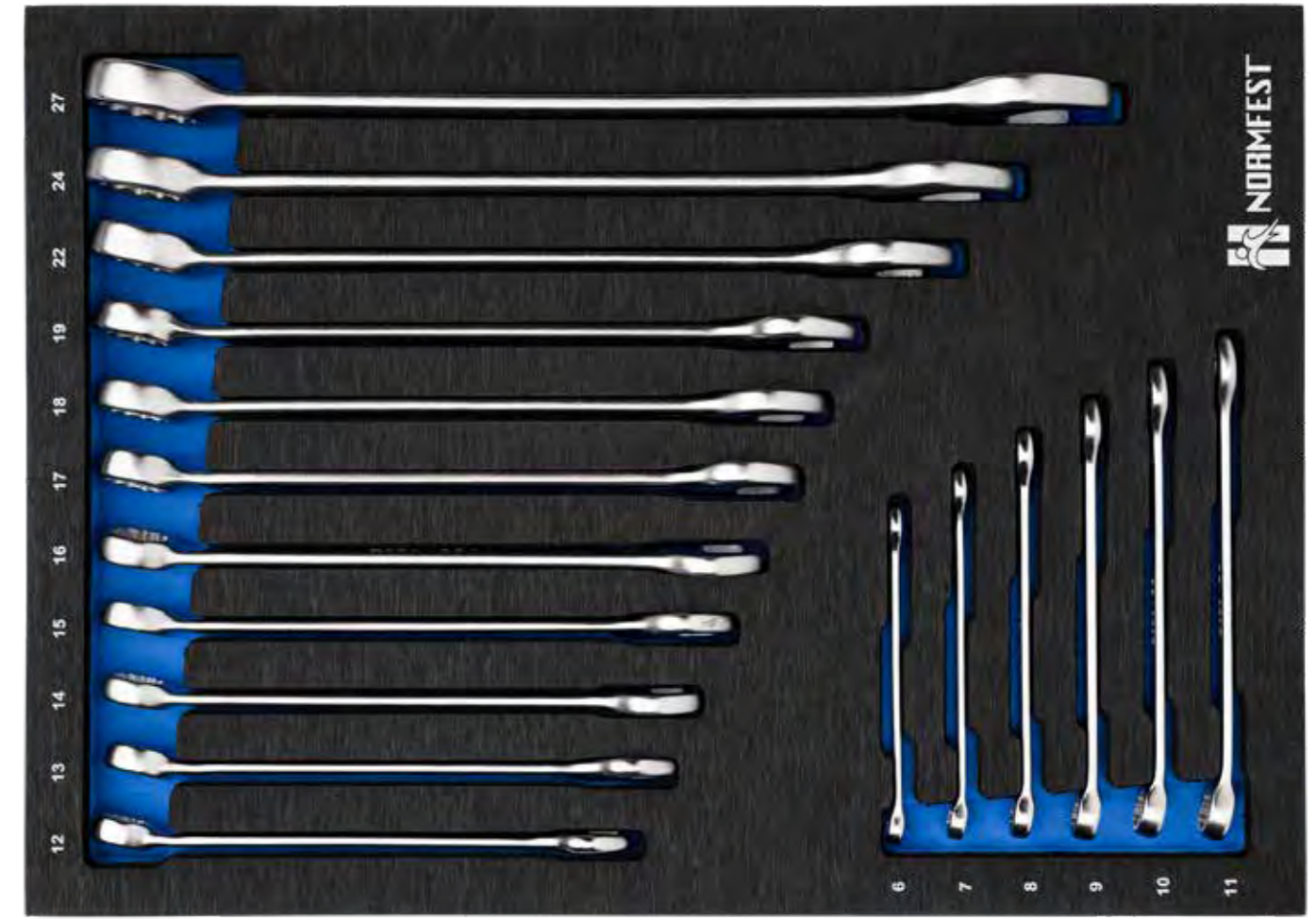
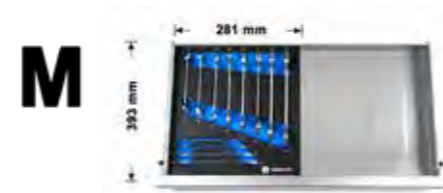

02  
**Combination wrench set**  
 17 pieces, drawer size M

► Item no. [7716-000-010](#)

The set consists of:

► **1" Sliding piece**

Item No.	length	Item No.	length
7716-300-6	105 mm	7716-300-16	205 mm
7716-300-7	115 mm	7716-300-17	215 mm
7716-300-8	125 mm	7716-300-18	225 mm
7716-300-9	135 mm	7716-300-19	230 mm
7716-300-10	145 mm	7716-300-20	245 mm
7716-300-11	155 mm	7716-300-21	285 mm
7716-300-12	165 mm	7716-300-24	285 mm
7716-300-13	175 mm	7716-300-27	310 mm
7716-300-14	185 mm		
7716-300-15	195 mm		

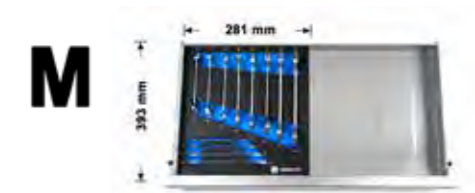

Illustrations may differ from the original.





01

**Articulated ratchet combination wrench set**

13 pieces, drawer size M

► Item no. [7716-000-014](#)

The set consists of:

► **Hinged ratchet combination spanner**

Item No.	length
7716-500-8	135 mm
7716-500-9	140 mm
7716-500-10	160 mm
7716-500-11	165 mm
7716-500-12	170 mm
7716-500-13	180 mm
7716-500-14	185 mm
7716-500-15	200 mm
7716-500-16	210 mm
7716-500-17	225 mm
7716-500-18	235 mm
7716-500-19	245 mm
7716-500-21	285 mm

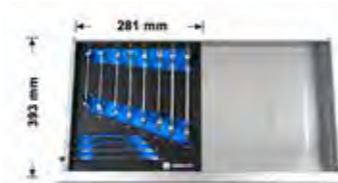
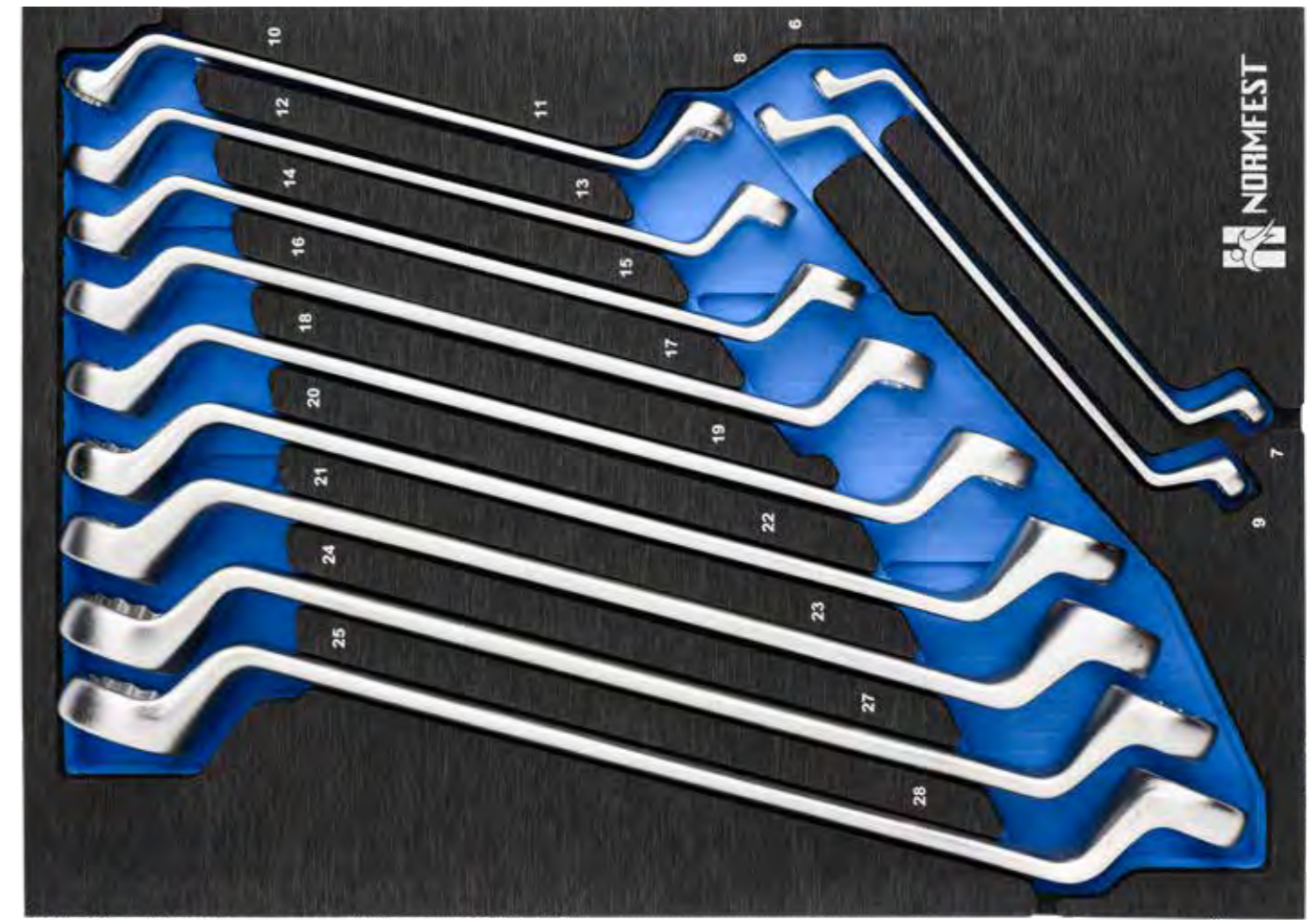
**M***Illustrations may differ from the original.*

02

**Double ring spanner set**

11 pieces, drawer size M

► Item no. [7716-000-009](#)

The set consists of:

► **box wrench socket**

\*\*\*???\* AGTB Standard:3

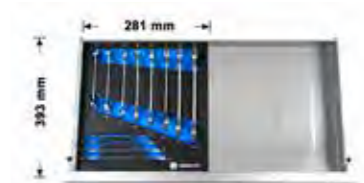
**M**



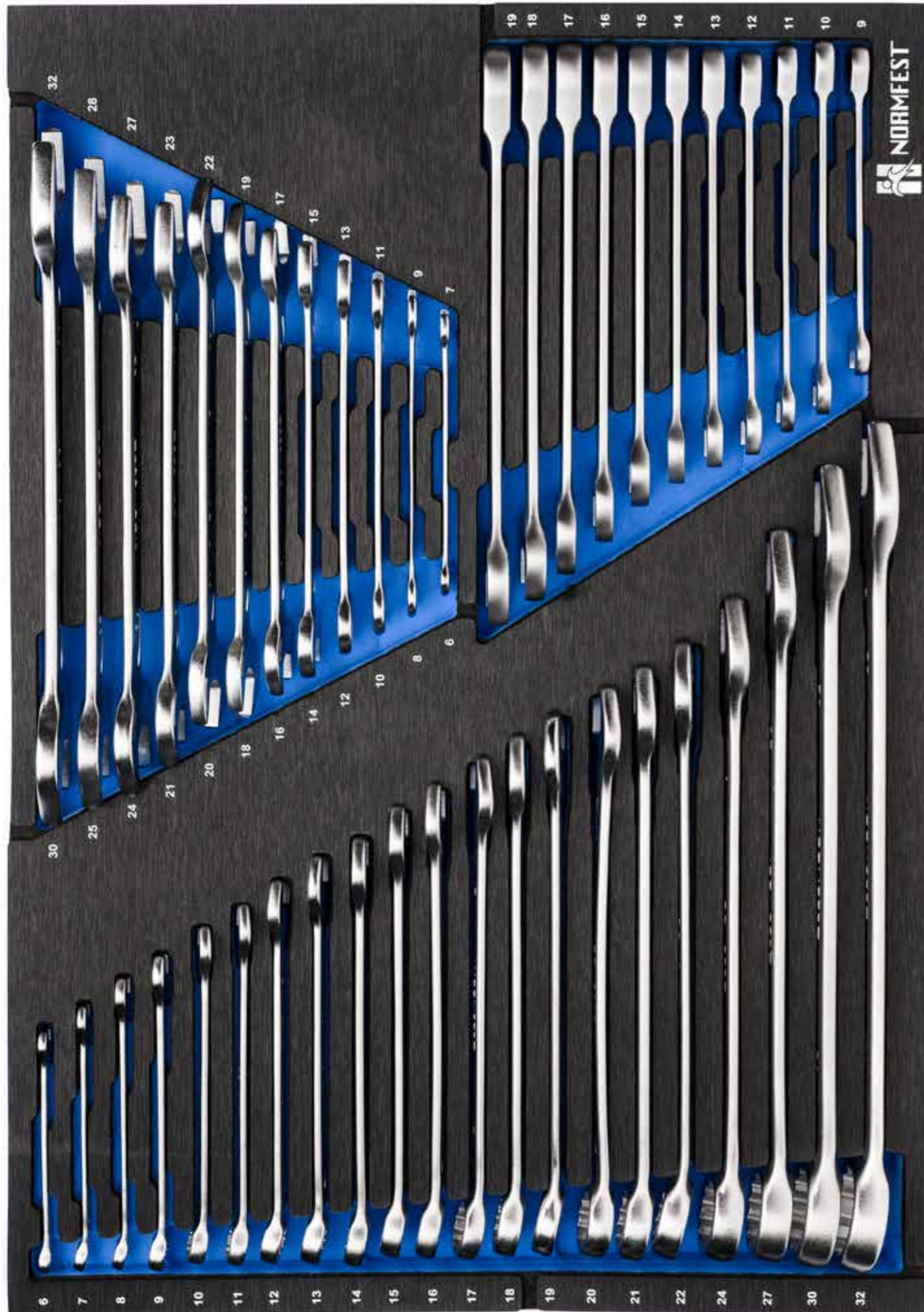

Illustrations may differ from the original.

01

**Ratchet combination wrench set**

44-part drawer size L

► Item no. [7716-000-017](#)

The set consists of:

► 1" Sliding piece

\*\*\*???\*

► 1" reversible ratchet

Item No.	length
7716-206-7	125 mm
7716-208-9	140 mm
7716-210-11	155 mm
7716-212-13	170 mm
7716-214-15	185 mm
7716-216-17	205 mm
7716-218-19	215 mm
7716-220-22	230 mm
7716-221-23	240 mm
7716-224-27	255 mm
7716-225-28	280 mm
7716-230-32	290 mm

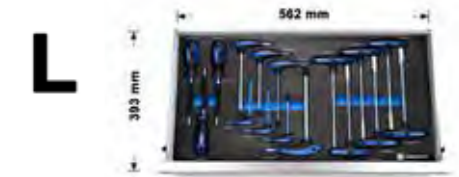

► Ratchet combination spanner without joint

Item No.	length
7716-400-9	140 mm
7716-400-10	160 mm
7716-400-11	170 mm
7716-400-12	175 mm
7716-400-13	180 mm
7716-400-14	185 mm
7716-400-15	200 mm
7716-400-16	230 mm
7716-400-17	225 mm
7716-400-18	235 mm
7716-400-19	245 mm





01

**Set of pliers**

4-part, drawer size M

▶ Item no. [7716-000-019](#)

The set consists of:

- ▶ **Needle nose pliers** (Item no. [7716-030-1](#))
- ▶ **Combination pliers** (Item no. [7716-030-2](#))
- ▶ **Side cutter** (Item no. [7716-030-3](#))
- ▶ **Water pump pliers** (Item no. [7716-030-4](#))

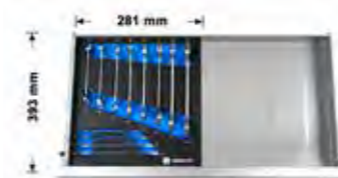
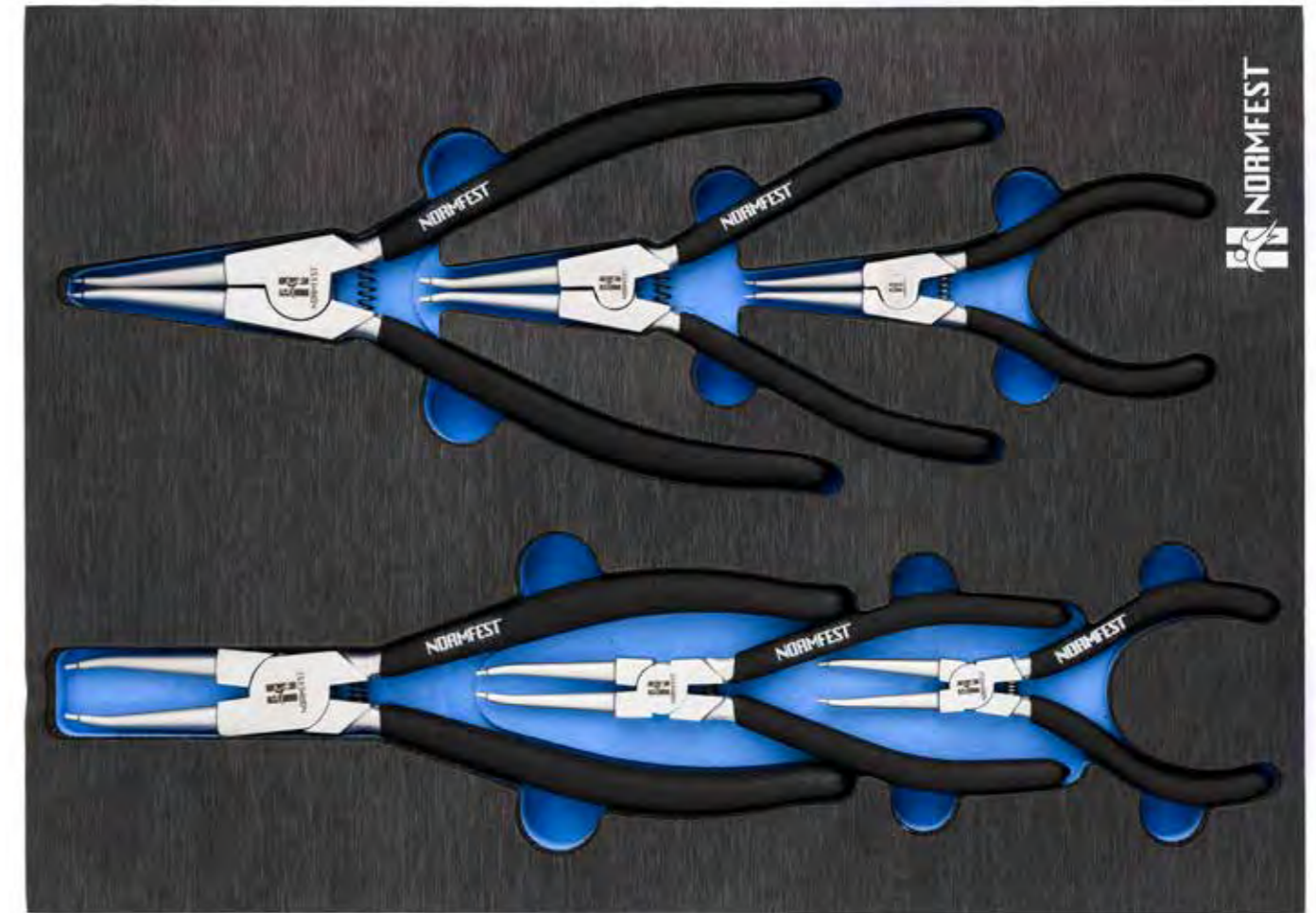
**M***Illustrations may differ from the original.*

02

**Safety pliers set**

6 parts, drawer size M

▶ Item no. [7716-000-012](#)

The set consists of:

- ▶ **Pliers for retaining rings for shafts of 10-25 mm** (Item no. [7716-030-8](#))
- ▶ **Pliers for retaining rings for bores of 12-25 mm** (Item no. [7716-030-7](#))
- ▶ **Pliers for retaining rings for shafts from 19-60 mm** (Item no. [7716-030-5](#))
- ▶ **Pliers for retaining rings for bores from 19-60 mm** (Item no. [7716-030-6](#))
- ▶ **Pliers for retaining rings for shafts from 40-100 mm** (Item no. [7716-030-10](#))
- ▶ **Pliers for retaining rings for bores from 40-100 mm** (Item no. [7716-030-9](#))

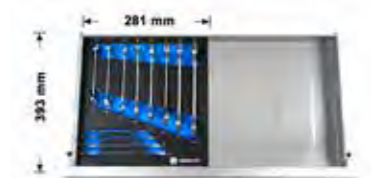
**M**





01  
**Screwdriver set**  
12 pieces, drawer size M



**M**

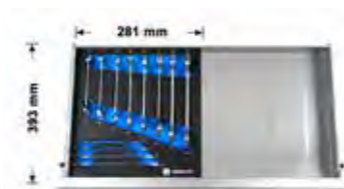

► Item no. [7716-000-011](#)

The set consists of:

► **1/4" sliding handle**

Item No.	Blade length	Blade width
7716-020-10	75 mm	3 mm
7716-020-14	100 mm	4 mm
7716-020-7	4.5 mm	5.5 mm
7716-020-6	150 mm	6.5 mm
7716-020-9	150 mm	8 mm
7716-020-13	200 mm	10 mm

► **1/4" Swivel extension 1/4"**

\*\*\*???\* AGTB Standard:1

► **Slotted screwdriver, short**

\*\*\*???\* AGTB Standard:1

► **Cross-recess screwdriver, short**

\*\*\*???\* AGTB Standard:2

02  
**Impact screwdriver set**  
7 pieces, drawer size M



**M**

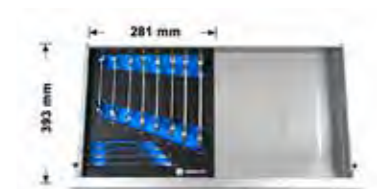

► Item no. [7716-000-013](#)

The set consists of:

► **Slotted screwdriver? with striking cap**

Item No.	Blade length	Blade width
7716-020-21	75 mm	5 mm
7716-020-18	100 mm	6 mm
7716-020-22	6 X 150 mm	8 mm
7716-020-19	6 X 150 mm	10 mm

► **Phillips screwdriver with striking cap**

Item No.
7716-020-20
7716-020-17
7716-020-16

Illustrations may differ from the original.



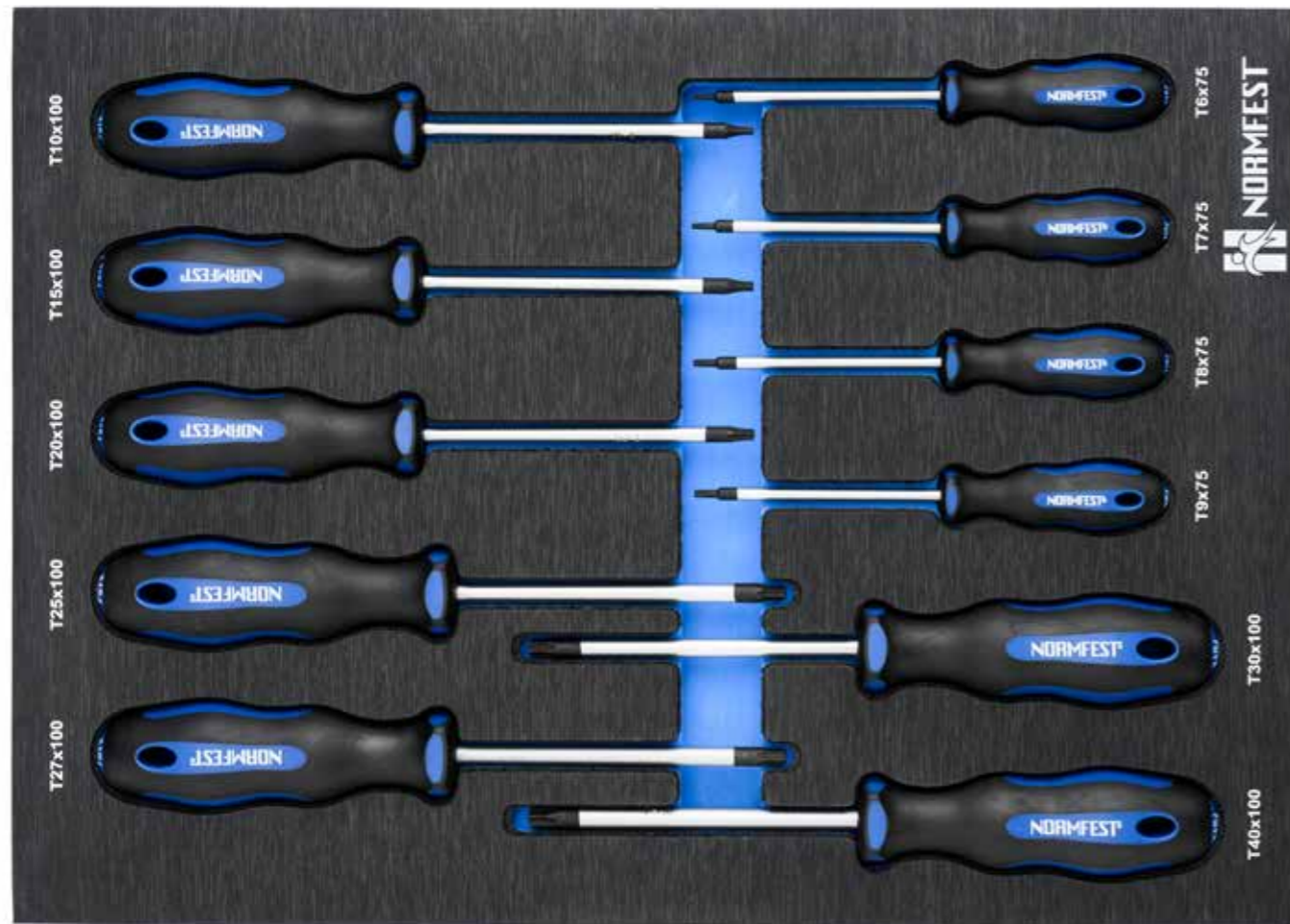

01

**TORX screwdriver set**  
 11 pieces, drawer size M
► Item no. [7716-000-021](#)

The set consists of:

► **Slotted screwdriver with striking cap****Item No.**

7716-020-39  
 7716-020-40  
 7716-020-41  
 7716-020-42  
 7716-020-43  
 7716-020-44  
 7716-020-45  
 7716-020-46  
 7716-020-47  
 7716-020-48  
 7716-020-49

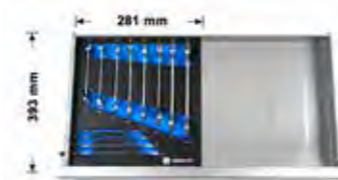
**M**

02

**Electronics screwdriver set**  
 6 pieces
► Item no. [7716-000-020](#)

The set consists of:

► **Elektronic Screwdrivers**

Länge	Blade width
60 mm	SL 1,5 mm
60 mm	SL 2,0 mm
60 mm	SL 2,5 mm
60 mm	SL 3,0 mm
60 mm	PH 0
60 mm	PH 00





Abbildungen können vom Original abweichen.

01

**T- / L-handle screwdriver set**

16 pieces, drawer size L

▶ Item no. [7716-000-024](#)

The set consists of:

▶ **T-handle screwdriver, hexagon socket**

\*\*\*????\*\* AGTB Standard:2

▶ **Flexible screwdriver, external hexagon**

\*\*\*????\*\* AGTB Standard:3

▶ **L-handle screwdriver, hexagon socket**

\*\*\*????\*\* AGTB Standard:1







01

**Hammer, chisel and pin punch set**

11 pieces, drawer size M

► Item no. [7716-000-022](#)

The set consists of:

► **3/8" Cardangelenk**

Item No.	width
7716-040-10	2 mm
7716-040-3	3 mm
7716-040-7	4 mm
7716-040-11	5 mm
7716-040-4	6 mm
7716-040-8	8 mm

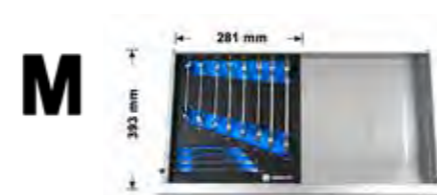
► **Flat chisel (Item no. 7716-040-1)**► **Cross chisel (Item no. 7716-040-5)**► **Grains (Item no. 7716-040-2)**► **Engineer's hammer 800g (Item no. 7716-040-6)**► **Plastic hammer (Item no. 7716-040-9)**

Illustrations may differ from the original.

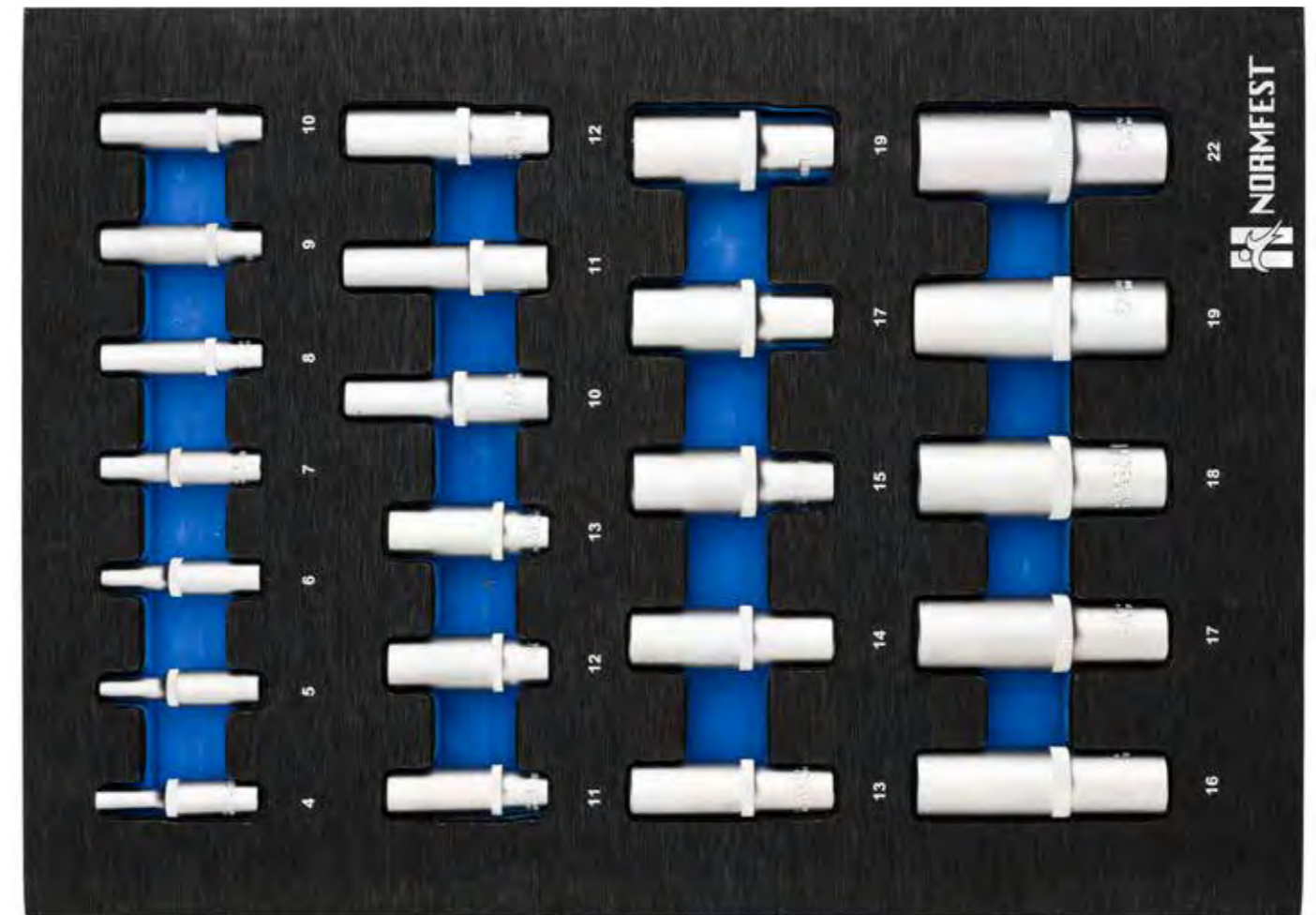

02

**1/4", 3/8", 1/2" socket wrench set, long**

23 pieces, drawer size M

► Item no. [7716-000-007](#)

The set consists of:

► **1/4" socket wrench insert, long**

Item No.
7716-141-104
7716-141-105
7716-141-106
7716-141-107
7716-141-108
7716-141-109
7716-141-110
7716-141-111
7716-141-112
7716-141-113

► **3/8" socket wrench insert, long**

\*\*\*???\* AGTB Standard:2

► **1/2" socket wrench insert, long**

\*\*\*???\* AGTB Standard:2

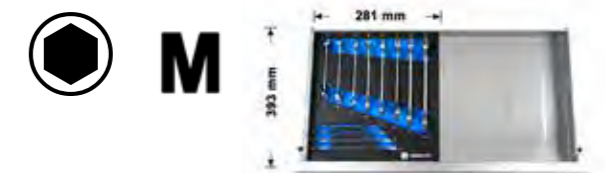





01

**1/2" „XZN socket wrench set**  
22 pieces, drawer size M

125 1/2" 

M

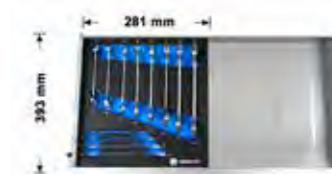

► Item no. [7716-000-015](#)

The set consists of:

► **1/2" multi-tooth socket, 55 mm**

**Item No.**

7716-125-005  
7716-125-006  
7716-125-008  
7716-125-009  
7716-125-010  
7716-125-012  
7716-125-014  
7716-125-016

► **1/2" multi-tooth socket, 100 mm**

**Item No.**

7716-125-105  
7716-125-106  
7716-125-108  
7716-125-109  
7716-125-110  
7716-125-112  
7716-125-114

► **1/2" multi-tooth socket, 140 mm**

**Item No.**

7716-125-205  
7716-125-206  
7716-125-208  
7716-125-209  
7716-125-210  
7716-125-212  
7716-125-214

*Illustrations may differ from the original.*





01

**1/2" TORX® socket wrench insert**  
26 pieces, drawer size M

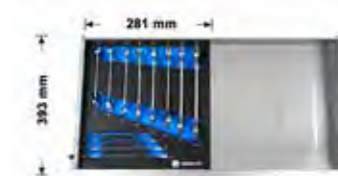

► Item no. [7716-000-016](#)

The set consists of:

► **1/2" TORX® Socket, 55 mm**

**Item No.**

- 7716-124-020
- 7716-124-025
- 7716-124-027
- 7716-124-030
- 7716-124-040
- 7716-124-045
- 7716-124-050
- 7716-124-055
- 7716-124-060
- 7716-124-070

► **1/2" TORX® Socket, 100 mm**

**Item No.**

- 7716-124-120
- 7716-124-125
- 7716-124-127
- 7716-124-130
- 7716-124-140
- 7716-124-145
- 7716-124-150
- 7716-124-155
- 7716-124-160
- 7716-124-170

► **1/2" TORX® Socket, 140 mm**

**Item No.**

- 7716-124-240
- 7716-124-245
- 7716-124-250
- 7716-124-255
- 7716-124-260
- 7716-124-270

*Illustrations may differ from the original.*





01

**1/2" „INBUS socket set**  
24 pieces, drawer size M

125 1/2" 

M

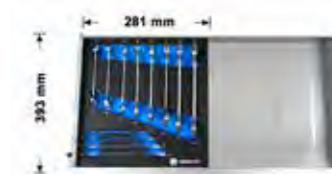

► Item no. [7716-000-023](#)

The set consists of:

► **1/2" Allen key socket, 55 mm**

**Item No.**

7716-122-005  
7716-122-006  
7716-122-007  
7716-122-008  
7716-122-010  
7716-122-012  
7716-122-014  
7716-122-017  
7716-122-019

► **1/2" Allen key socket, 100 mm**

**Item No.**

7716-122-105  
7716-122-106  
7716-122-107  
7716-122-108  
7716-122-110  
7716-122-111  
7716-122-112  
7716-122-113

► **1/2" Allen key socket, 140 mm**

**Item No.**

7716-122-205  
7716-122-206  
7716-122-207  
7716-122-208  
7716-122-210  
7716-122-212  
7716-122-214





01

**3/4 „socket wrench set**  
20 pieces, drawer size L

**20** 3/4" 



► Item no. [7716-000-018](#)

The set consists of:

- 3/4 „sliding handle (Item no. 7716-340-005)
- 3/4 „reversible ratchet (Item no. 7716-340-001)
- 3/4 „extension

Item No.	length
7716-340-002	100 mm
7716-340-003	200 mm
7716-340-004	400 mm

- 3/4 „socket wrench insert

\*\*\*???\* AGTB Standard:2

*Illustrations may differ from the original.*





01

**1/2 „hexagon socket wrench set**  
25 pieces, drawer size M

► Item no. [7716-000-004](#)

The set consists of:

- 1/2“ adapter to 3/8 (Item no. 7716-120-015)
- 1/2“ universal joint (Item no. 7716-120-017)
- 1/2“ reversible ratchet (Item no. 7716-120-001)
- 1/2“ extension  
\*\*\*???\* AGTB Standard:2

- 1/2 „spark plug insert

Item No.  
7716-121-716  
7716-121-721

- 1/2“ Socket spanner, hexagon socket

\*\*\*???\* AGTB Standard:4







01  
**3/8 „socket wrench set**  
 62 pieces, drawer size M

► Item no. [7716-000-006](#)

The set consists of:

- 3/8 „BIT adapter (Item no. 7716-380-007)
- 3/8 „universal joint (Item no. 7716-380-006)
- 3/8 „sliding piece / adapter (Item no. 7716-380-005)
- 3/8 „fine-tooth reversible ratchet (Item no. 7716-380-001)
- 3/8 „extension

\*\*\*???\* AGTB Standard:2

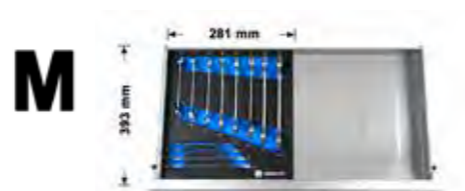

► 3/8“ screwdriver bit, slotted

- Item No.**  
 7716-386-001  
 7716-386-002  
 7716-386-003

► 3/8“ screwdriver bit, cross recess

- Item No.**  
 7716-386-201  
 7716-386-202  
 7716-386-203

► 3/8“ screwdriver bit, Pozidriv

- Item No.**  
 7716-386-101  
 7716-386-102  
 7716-386-103

► 3/8“ screwdriver bit, TORX®

\*\*\*???\* AGTB Standard:2

► 3/8 „socket wrench insert

Item No.	length
7716-381-006	28 mm
7716-381-007	28 mm
7716-381-008	28 mm
7716-381-009	28 mm
7716-381-010	28 mm
7716-381-011	28 mm
7716-381-012	28 mm
7716-381-013	28 mm
7716-381-014	28 mm
7716-381-015	28 mm
7716-381-016	28 mm
7716-381-017	30 mm
7716-381-018	30 mm
7716-381-019	30 mm
7716-381-020	30 mm
7716-381-021	30 mm
7716-381-022	30 mm
7716-381-024	30 mm

► 3/8“ socket spanner long

**Item No.**

7716-381-108
7716-381-109
7716-381-110
7716-381-111
7716-381-112
7716-381-113
7716-381-114
7716-381-115
7716-381-117
7716-381-119

► 3/8“ Spark plug socket, hexagonal head

\*\*\*???\* AGTB Standard:2

► 3/8“ socket spanner, hexagon socket

- Item No.**  
 7716-382-003  
 7716-382-004  
 7716-382-005  
 7716-382-006  
 7716-382-007  
 7716-382-008  
 7716-382-010



01

**1/4 „socket wrench set**

68 pieces, drawer size M

▶ Item no. [7716-000-005](#)

The set consists of:

- ▶ 3/8 „adapter to 1/4“ (Item no. 7716-380-017)
- ▶ 1/4 „sliding handle (Item no. 7716-140-009)
- ▶ 1/4 „plug-in handle (Item no. 7716-140-008)
- ▶ 1/4 „universal joint (Item no. 7716-140-014)
- ▶ 1/4“ reversible ratchet (Item no. 7716-140-001)

## ▶ 1/4 „extension

Art.-Nr.	Länge
7716-140-016	50 mm
7716-140-005	100 mm

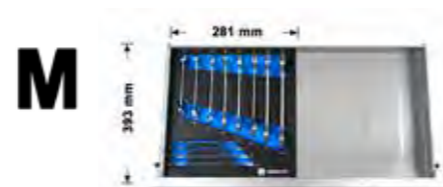
▶ 1/4 „flexible extension  
(Item no. 7716-140-015)

Illustrations may differ from the original.

## ▶ 1/4“ screwdriver bit, slotted

\*\*\*???\* AGTB Standard:2

## ▶ 1/4“ screwdriver bit, cross recess

\*\*\*???\* AGTB Standard:2

## ▶ 1/4“ screwdriver bit, Pozidriv

\*\*\*???\* AGTB Standard:2

## ▶ 1/4“ screwdriver bit, TORX®

\*\*\*???\* AGTB Standard:2

## ▶ 1/4“ screwdriver bit

Art.-Nr.	Schlüsselweite
7716-020-3	1,3 mm
7716-020-1	1,5 mm
7716-020-50	2,0 mm
7716-020-2	2,5 mm

## ▶ 1/4“ Socket spanner, external hexagon, 25 mm

Item No.
7716-141-004
7716-141-045
7716-141-005
7716-141-055
7716-141-006
7716-141-007
7716-141-008
7716-141-009
7716-141-010
7716-141-011
7716-141-012
7716-141-013
7716-141-014

## ▶ 1/4“ Socket spanner, external hexagon, 50 mm

\*\*\*???\* AGTB Standard:2

## ▶ 1/4“ Screwdriver bit socket, TORX® with spigot guide

Item No.
7716-144-409
7716-144-410
7716-144-415
7716-144-420
7716-144-425
7716-144-427
7716-144-430

## ▶ 1/4“ screwdriver bit, hexagon socket (Inbus)

Item No.
7716-142-003
7716-142-004
7716-142-005
7716-142-006
7716-142-007
7716-142-008

## ▶ 1/2“ Socket spanner, TORX®

Item No.
7716-143-004
7716-143-005
7716-143-006
7716-143-007
7716-143-008
7716-143-010
7716-143-011





01

**1/4", 3/8", 1/2" socket wrench set**  
122-teilig Schubladengröße L

▶ Item no. [7716-000-002](#)

The set consists of:



- ▶ 1/4" „sliding handle” (Item no. 7716-140-009)
- ▶ 1/4" „plug-in handle” (Item no. 7716-140-008)
- ▶ 1/4" „universal joint” (Item no. 7716-140-014)
- ▶ 1/4" „adapter to 1/4"” (Item no. 7716-140-006)
- ▶ 1/4" „fine-tooth reversible ratchet” (Item no. 7716-140-001)

- ▶ 1/4" „extension”  
Item No. length  
7716-140-016 50 mm  
7716-140-005 100 mm

- ▶ 1/4" screwdriver bit, slotted

- Item No.  
7716-146-200  
7716-146-201  
7716-146-202  
7716-146-203

- ▶ 1/4" screwdriver bit, cross recess

\*\*\*???\* AGTB Standard:3

- ▶ 1/4" screwdriver bit

Art.-Nr.	Schlüsselweite
7716-020-3	1,3 mm
7716-020-1	1,5 mm
7716-020-50	2,0 mm
7716-020-2	2,5 mm

- ▶ 1/4" screwdriver bit, Pozidriv

Art.-Nr.	Schlüsselweite
7716-146-100	PZ0
7716-146-101	PZ1
7716-146-102	PZ2

- ▶ 1/4" screwdriver bit, TORX®

Art.-Nr.	Width across flats
7716-144-009	T9
7716-144-010	T10
7716-144-015	T15
7716-144-020	T20
7716-144-025	T25
7716-144-030	T30

- ▶ 1/4" Screwdriver bit socket, TORX® with spigot guide

- Item No.  
7716-144-409  
7716-144-410  
7716-144-415  
7716-144-420  
7716-144-425  
7716-144-427  
7716-144-430

- ▶ 1/4" screwdriver bit, hexagon socket (Inbus)  
\*\*\*???\* AGTB Standard:2

- ▶ 1/4" Socket spanner, external hexagon, 25 mm

- Item No.  
7716-141-004  
7716-141-045  
7716-141-005  
7716-141-055  
7716-141-006  
7716-141-007  
7716-141-008  
7716-141-009  
7716-141-010  
7716-141-011  
7716-141-012  
7716-141-013  
7716-141-014

- ▶ 1/4" Socket spanner, external hexagon, 50 mm

\*\*\*???\*

- ▶ 1/4" socket spanner, Torx®

\*\*\*???\* AGTB Standard:2

- ▶ 3/8" „universal joint” (Item no. 7716-380-006)

- ▶ 3/8" „BIT adapter” (Item no. 7716-380-007)

- ▶ 3/8" „fine-tooth reversible ratchet” (Item no. 7716-380-001)

- ▶ 3/8" „extension” (Item no. 7716-380-010)

- ▶ 3/8" socket spanner, hexagon socket

\*\*\*???\* AGTB Standard:2

- ▶ 3/8" Hexagon socket, 63 mm

\*\*\*???\* AGTB Standard:3

- ▶ 3/8" Socket spanner, Torx®

\*\*\*???\* AGTB Standard:2

- ▶ 3/8" socket spanner, Inbus

\*\*\*???\* AGTB Standard:3

- ▶ 1/2" „slider” (Item no. 7716-120-016)

- ▶ 1/2" „universal joint” (Item no. 7716-120-017)

- ▶ 1/2" „adapter to 5/16"” (Item no. 7716-120-018)

- ▶ 1/2" „fine-tooth reversible ratchet” (Item no. 7716-120-001)

- ▶ 1/2" extension  
\*\*\*???\* AGTB Standard:2

- ▶ 1/2" Socket spanner, short  
\*\*\*???\* AGTB Standard:3

- ▶ 1/2" Socket spanner, external hexagon, 77 mm

\*\*\*???\*

- ▶ 1/2" Socket spanner, TORX®

\*\*\*???\* AGTB Standard:2

- ▶ 1/2" Spark Plug Socket, TORX®

- Item No.  
7716-121-716  
7716-121-721

01

**Files set**

5-piece, drawer size S

- ▶ Item no. [7716-000-027](#)

The set consists of:

- ▶ 1 x File triangle  
(Item no. 7716-040-12)
- ▶ 1 x File flat hand  
(Item no. 7716-040-13)
- ▶ 1 x File half round  
(Item no. 7716-040-14)
- ▶ 1 x File round  
(Item no. 7716-040-15)
- ▶ 1 x File oblique  
(Item no. 7716-040-16)

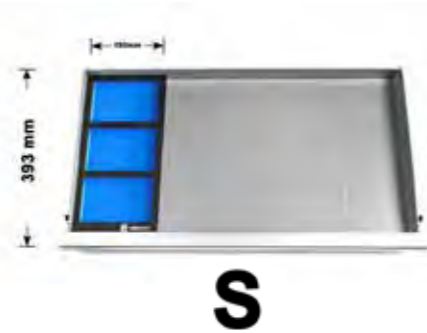

02

**Maul Ring Ratchet Set 15° 8-15mm**

6-piece, drawer size S

- ▶ Item no. [7716-000-028](#)

The set consists of:

- ▶ 1 x SW 8  
(Item no. 7716-600-8)
- ▶ 1 x SW 10  
(Item no. 7716-600-10)
- ▶ 1 x SW 11  
(Item no. 7716-600-11)
- ▶ 1 x SW 12  
(Item no. 7716-600-12)
- ▶ 1 x SW 13  
(Item no. 7716-600-13)
- ▶ 1 x SW 15  
(Item no. 7716-600-15)



03

**Maul ring ratchet set 15° 16-22mm**

6-piece, drawer size S

- ▶ Item no. [7716-000-029](#)

The set consists of:

- ▶ 1 x SW 16 (Item no. 7716-600-16)
- ▶ 1 x SW 17 (Item no. 7716-600-17)
- ▶ 1 x SW 18 (Item no. 7716-600-18)
- ▶ 1 x SW 19 (Item no. 7716-600-19)
- ▶ 1 x SW 21 (Item no. 7716-600-21)
- ▶ 1 x SW 22 (Item no. 7716-600-22)

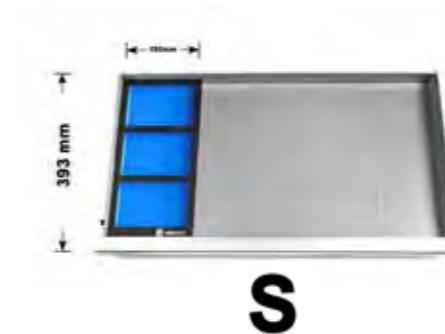



01

**Bit Box**

32-piece

- ▶ Item no. [7716-070-1](#)



02

**Bit Box 1/4**

32-piece

- ▶ Item no. [7716-070-4](#)



03

**Bit holder**

Quick Release

- ▶ Item no. [7716-070-3](#)



04

**Bit Box**

57-piece long

- ▶ Item no. [7716-070-2](#)



*Illustrations may differ from the original.*

05

**Normfest knee pad**

- ▶ Art.-Nr. [7716-060-5](#)

## ▶ Product description

- excellent as a pad for the knees
- for work such as changing microfilters in vehicle interiors (glove compartments)
- extremely light
- fits in any drawer



06

**Normfest Cutter Knife**

- ▶ Art.-Nr. [7716-060-1](#)

## ▶ Product description

- sturdy plastic
- rubberised sheathing for a firm grip
- easy and safe replacement of the blade
- with one black blade



07

**Normfest Cutter Knife**

- ▶ Art.-Nr. [7716-060-2](#)

## ▶ Product description

- made of full metal
- for tough use
- easy and safe replacement of the blade
- with a black blade



08

**Normfest safety cutter knife**

- ▶ Art.-Nr. [7716-060-3](#)

## ▶ Product description

- with 2 function levels
- automatic retraction when the blade is not in use
- lock for the permanently extended blade
- with one black trapezoid blade







Torque wrench



01

**Torque wrench**

No more turning back necessary

► **Product description**

- MADE IN GERMANY
- It is no longer necessary to turn back the torque wrench to relieve the pressure spring
- Tested according to DIN EN ISO 6789-2: 2017 with calibration certificate, serial number and application information
- Secure locking, exact setting
- Release accuracy  $\pm 4\%$  of the set value
- Torque release - controllable: by automatic short-travel release - acoustic: by clicking sound
- Wide range of uses for controlled screw tightening in tire service, two-wheeler, passenger car, commercial vehicle applications as well as various individual cases in industry and craft
- External square according to DIN 3120, ISO 1174-1
- Double scale (Nm / lbf.ft)
- Delivery in a sturdy hexa rotating pack



**Made in  
Germany**



02

**1/4 „torque wrench**

Workspace 1-6 Nm

► **Item no. [7716-1-6](#)**

05

**1/2 „torque wrench**

Workspace 40-200 Nm

► **Item no. [7716-40-200](#)**

03

**1/4 „torque wrench**

Workspace 5-25 Nm

► **Item no. [7716-5-25](#)**

06

**1/2 „torque wrench**

Workspace 60-320 Nm

► **Item no. [7716-60-320](#)**

04

**3/8 „torque wrench**

Workspace 10-60 Nm

► **Item no. [7716-10-60](#)**

07

**3/4 „torque wrench**

Workspace 300-850 Nm

► **Item no. [7716-300-850](#)**

Length: 1268 mm

Length: 621 mm

Length: 552 mm

Length: 355 mm

Length: 276 mm

Length: 236 mm

02

03

04

05

06

07

Illustrations may differ from the original.





Disposable protection





01  
**1/4 „socket wrench set**  
 68 pieces, drawer size M

► Item no. [7716-000-005](#)

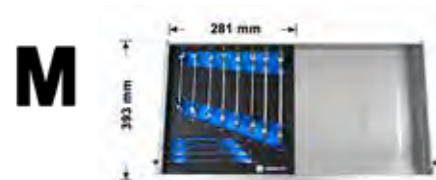

02  
**1/4“ TORX® socket wrench insert**  
 Cross recess (PH) 38 mm

**Item No.**  
 7716-146-000  
 7716-146-001  
 7716-146-002  
 7716-146-003



03  
**1/4 „screwdriver socket**  
 Pozidriv (PZ) 49 mm

**Item No.**  
 7716-146-100  
 7716-146-101  
 7716-146-102  
 7716-146-103



04  
**1/4“ TORX® socket wrench insert**  
 Slot (SL) 38 mm

**Item No.**  
 7716-146-200  
 7716-146-201  
 7716-146-202  
 7716-146-203



Illustrations may differ from the original.

01

**1/4" TORX® socket wrench insert**

Hexagon socket (Inbus) 38 mm

**Item No.**

7716-142-003  
7716-142-004  
7716-142-005  
7716-142-006  
7716-142-007  
7716-142-008



02

**1/4" TORX® socket wrench insert**

TORX® (T) 38 mm

**Item No.**

7716-144-008  
7716-144-009  
7716-144-010  
7716-144-015  
7716-144-020  
7716-144-025  
7716-144-027  
7716-144-030  
7716-144-035  
7716-144-040



03

**1/4" TORX® socket wrench insert**

TORX® with peg guide (TH) 38 mm

**Item No.**

7716-144-409  
7716-144-410  
7716-144-415  
7716-144-420  
7716-144-425  
7716-144-427  
7716-144-430



04

**Slip Socket 1/4**

\*\*\*???\* AGTB Standard:1



05

**1/4" Cardangelenk**

Hexagon socket 25 mm

**Item No.**

7716-141-004  
7716-141-045  
7716-141-005  
7716-141-055  
7716-141-006  
7716-141-007  
7716-141-008  
7716-141-009  
7716-141-010  
7716-141-011  
7716-141-012  
7716-141-013  
7716-141-014



06

**1/4" „socket wrench insert, long**

External hexagon 50 mm

**Item No.**

7716-141-104  
7716-141-105  
7716-141-106  
7716-141-107  
7716-141-108  
7716-141-109  
7716-141-110  
7716-141-111  
7716-141-112  
7716-141-113



*Illustrations may differ from the original.*



01

**1/2" Repair kit for reversible ratchet 7716-012-4**

Item No.	length
7716-140-016	50 mm
7716-140-005	100 mm



02

**1/4" Swivel extension**

Item No.	length
7716-140-010	36 mm
7716-140-011	74 mm
7716-140-012	254 mm

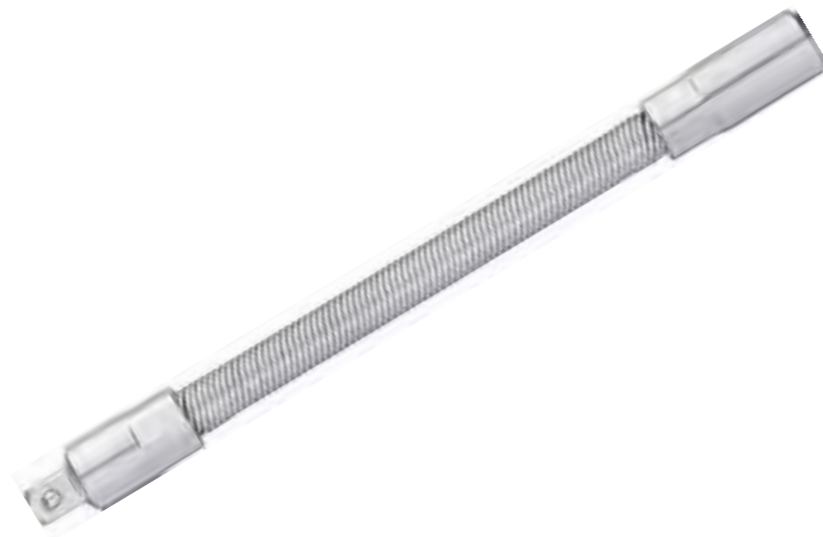

03

**1/4" „flexible extension**▶ Item no. [7716-140-015](#)

04

**1/4" „adapter to 3/8"**▶ Item no. [7716-140-013](#)

05

**1/4" „adapter to 1/4"**▶ Item no. [7716-140-006](#)

06

**1/2" internal multi-tooth screwdriver bit (XZN)**▶ Item no. [7716-140-007](#)*Illustrations may differ from the original.*



01  
1/4 „universal joint

► Item no. [7716-140-014](#)



02  
1/4 „sliding handle

► Art.-Nr. [7716-140-009](#)



03  
1/4 „plug-in handle

► Item no. [7716-140-008](#)



04  
1/4 „fine-tooth reversible ratchet  
72 teeth

► Item no. [7716-140-001](#)



05  
1/4 „repair set for reversible ratchet 7716-014-2

► Item no. [7716-140-004](#)

06  
1/4 „full steel reversible ratchet

► Item no. [7716-140-003](#)



07  
1/4 „repair set for reversible ratchet 7716-014-79

► Item no. [7716-140-002](#)



01

**3/8 „socket wrench set**

62 pieces, drawer size M

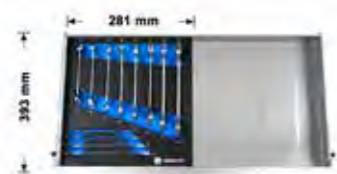
► Item no. [7716-000-006](#)**M**

02

**1/4 „, 3/8“, 1/2 „socket wrench set, long**

23 pieces, drawer size M

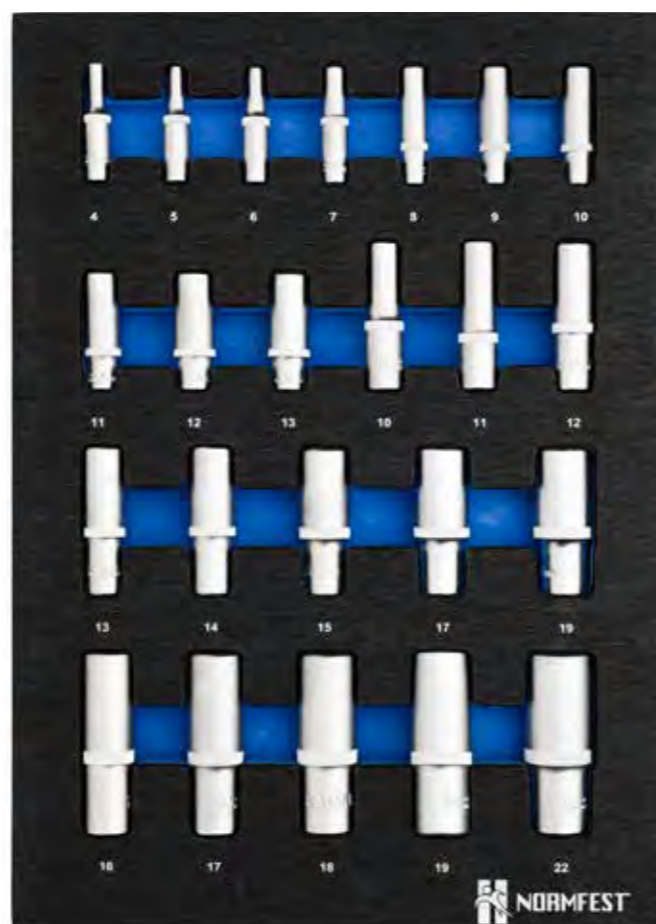
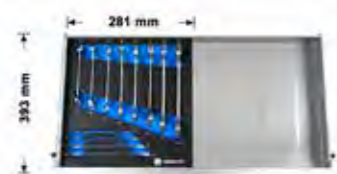
► Item no. [7716-000-007](#)**M**

03

**SW 10**

Cross recess (PH) 49 cm

**Item No.**

7716-386-201

7716-386-202

7716-386-203



04

**SW 10**

Pozidriv (PZ) 49 mm

**Item No.**

7716-386-101

7716-386-102

7716-386-103



05

**SW 10**

Slot (SL) 49 mm

**Item No.**

7716-386-001

7716-386-002

7716-386-003

*Illustrations may differ from the original.*



01

**SW 10**

Hexagon socket (Allen) 49 mm

**Item No.**

7716-382-003  
 7716-382-004  
 7716-382-005  
 7716-382-006  
 7716-382-007  
 7716-382-008  
 7716-382-010



02

**SW 10**

TORX® (T) 49 mm

**Item No.**

7716-384-015  
 7716-384-020  
 7716-384-025  
 7716-384-027  
 7716-384-030  
 7716-384-035  
 7716-384-040  
 7716-384-045  
 7716-384-047  
 7716-384-050  
 7716-384-055



03

**SW 10**

TORX® with spigot guide (TH) 48 mm

**Item No.**

7716-384-440  
 7716-384-445  
 7716-384-450



*Illustrations may differ from the original.*

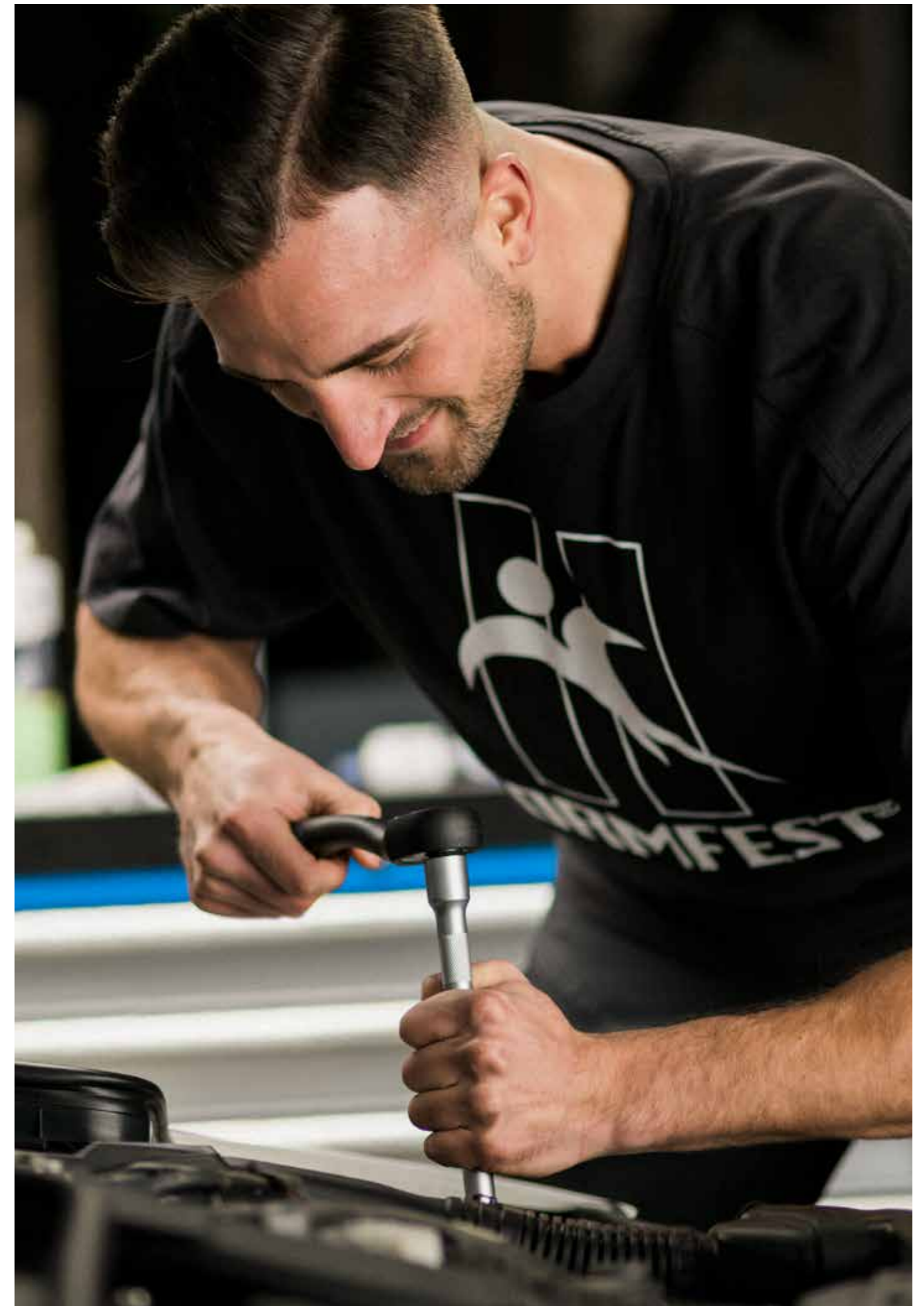



01

**3/8" spark plug socket**

Hexagon socket (Inbus)

Item No.	length
7716-381-006	28 mm
7716-381-007	28 mm
7716-381-008	28 mm
7716-381-009	28 mm
7716-381-010	28 mm
7716-381-011	28 mm
7716-381-012	28 mm
7716-381-013	28 mm
7716-381-014	28 mm
7716-381-015	28 mm
7716-381-016	28 mm
7716-381-017	30 mm
7716-381-018	30 mm
7716-381-019	30 mm
7716-381-020	30 mm
7716-381-021	30 mm
7716-381-022	30 mm
7716-381-024	30 mm



02

**3/8" spark plug socket**

Hexagon socket (Inbus) 63 mm

Item No.
7716-381-108
7716-381-109
7716-381-110
7716-381-111
7716-381-112
7716-381-113
7716-381-114
7716-381-115
7716-381-117
7716-381-119



03

**3/8" spark plug socket**

TORX® (T) 28 mm

Item No.
7716-383-004
7716-383-005
7716-383-006
7716-383-007
7716-383-008
7716-383-010
7716-383-011
7716-383-012
7716-383-014
7716-383-016
7716-383-018
7716-383-020



Illustrations may differ from the original.

04

**Slip Socket 3/8**

\*\*\*???\* AGTB Standard:1



05

**3/8 „adapter to 1/2“**▶ Item no. [7716-380-016](#)

06

**3/8 „adapter to 1/4“**▶ Item no. [7716-380-017](#)

07

**3/8 „BIT adapter**▶ Item no. [7716-380-007](#)

08

**3/8 „BIT adapter to 3/8“**▶ Item no. [7716-380-008](#)

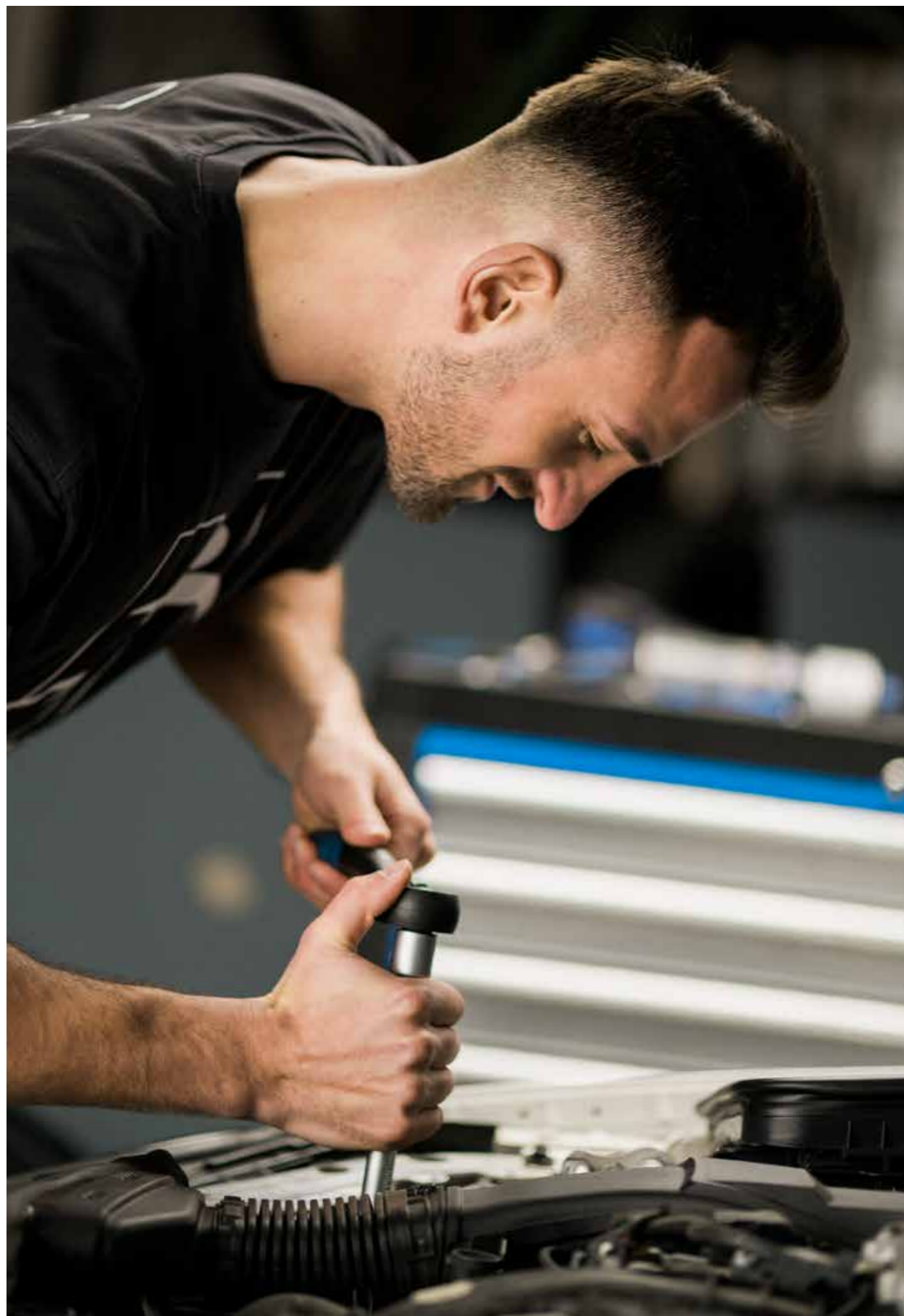

01

**SW 12**

Hexagon socket (Inbus) 66 mm

**Item No.**

7716-381-716

7716-381-718

7716-381-721



02

**3/8" Repair kit for reversible ratchet 7716-038-6****Item No.**

7716-380-009

7716-380-010

7716-380-012

**length**

75 mm

125 mm

250 mm



03

**3/8" Swivel extension****Item No.**

7716-380-013

7716-380-014

7716-380-015

**length**

36 mm

74 mm

254 mm

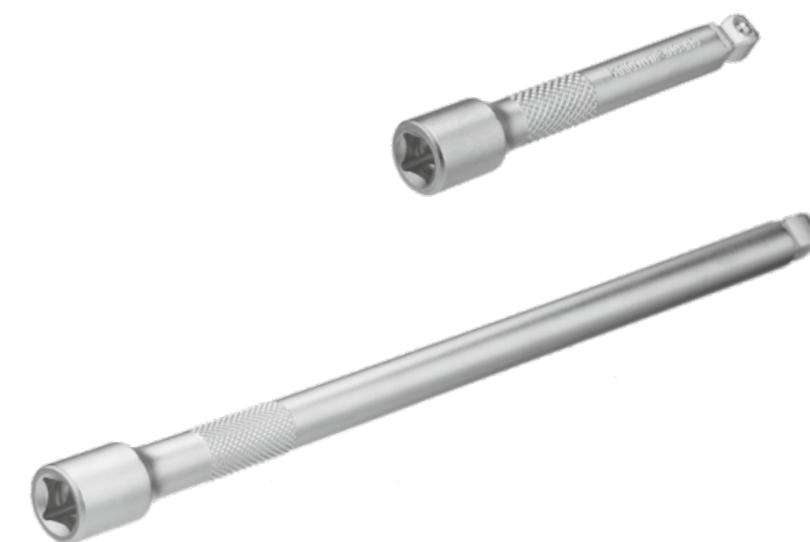

*Illustrations may differ from the original.*





01  
3/8 „sliding piece / adapter

► Item no. [7716-380-005](#)



02  
3/8 „universal joint

► Item no. [7716-380-006](#)



*Illustrations may differ from the original.*

04  
3/8 „fine-tooth reversible ratchet  
72 teeth

► Item no. [7716-380-001](#)



05  
3/8 „repair set for reversible ratchet 7716-038-3

► Item no. [7716-380-002](#)

06  
3/8 „full steel reversible ratchet

► Item no. [7716-380-003](#)



07  
3/8 „repair set for reversible ratchet 7716-038-6

► Item no. [7716-380-004](#)

01  
**1/2 „XZN socket wrench set**  
 22 pieces, drawer size M

► Item no. [7716-000-015](#)

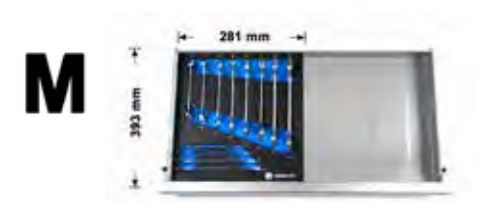

03  
**1/2 „INBUS socket set**  
 24 pieces, drawer size M

► Item no. [7716-000-023](#)

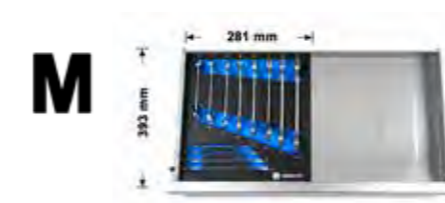

02  
**1/2 „TORX® socket wrench insert**  
 26 pieces, drawer size M

► Item no. [7716-000-016](#)

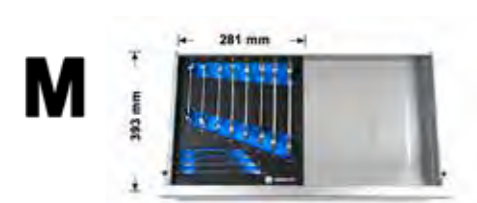

04  
**1/2 „hexagon socket wrench set**  
 25 pieces, drawer size M

► Item no. [7716-000-004](#)

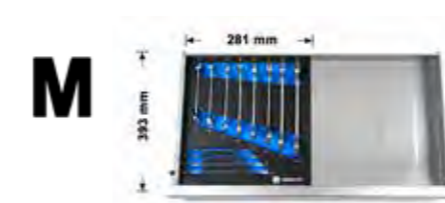

Illustrations may differ from the original.



01

**1/2" Swivel extension**

Item No.	length
7716-120-009	50 mm
7716-120-010	74 mm
7716-120-011	254 mm



02

**1/2" „sliding handle**▶ Item no. [7716-120-015](#)

03

**1/2" „slider**▶ Item no. [7716-120-016](#)

04

**1/2" „universal joint**▶ Item no. [7716-120-017](#)

05

**1/2" „fine-tooth reversible ratchet**

72 teeth

▶ Item no. [7716-120-001](#)

06

**1/2" Repair set for reversible ratchet 7716-012-6**▶ Item no. [7716-120-005](#)

07

**1/2" „full steel reversible ratchet**▶ Item no. [7716-120-003](#)

08

**1/2" „repair set for reversible ratchet 7716-012-4**▶ Item no. [7716-120-004](#)

09

**1/2" „articulated handle with reversible ratchet**

72 teeth

▶ Item no. [7716-120-014](#)

▶ Product description  
 - 670 mm total length  
 - 72 teeth



*Illustrations may differ from the original.*

01  
**1/2" screwdriver bit**  
TORX® (T) 55 mm



- Item No.**  
7716-124-020  
7716-124-025  
7716-124-027  
7716-124-030  
7716-124-040  
7716-124-045  
7716-124-050  
7716-124-055  
7716-124-060  
7716-124-070

02  
**1/2" screwdriver bit**  
TORX® (T) 100 mm



- Item No.**  
7716-124-120  
7716-124-125  
7716-124-127  
7716-124-130  
7716-124-140  
7716-124-145  
7716-124-150  
7716-124-155  
7716-124-160  
7716-124-170

03  
**1/2" screwdriver bit**  
TORX® (T) 140 mm



- Item No.**  
7716-124-240  
7716-124-245  
7716-124-250  
7716-124-255  
7716-124-260  
7716-124-270

04  
**1/2" screwdriver bit**  
TORX® (T) 200 mm



- Item No.**  
7716-124-340  
7716-124-345  
7716-124-350  
7716-124-355  
7716-124-360  
7716-124-370

05  
**1/2" socket spanner**  
External hexagon short



Item No.	length
7716-121-008	38 mm
7716-121-010	38 mm
7716-121-011	38 mm
7716-121-012	38 mm
7716-121-013	38 mm
7716-121-014	38 mm
7716-121-015	38 mm
7716-121-016	38 mm
7716-121-017	38 mm
7716-121-018	38 mm
7716-121-019	38 mm
7716-121-020	38 mm
7716-121-021	38 mm
7716-121-022	38 mm
7716-121-023	38 mm
7716-121-024	38 mm
7716-121-027	42 mm
7716-121-030	44 mm
7716-121-032	44 mm

06  
**1/2" socket spanner**  
External hexagon long, 77 mm



- Item No.**  
7716-121-110  
7716-121-111  
7716-121-112  
7716-121-113  
7716-121-114  
7716-121-115  
7716-121-116  
7716-121-117  
7716-121-118  
7716-121-119  
7716-121-122

07  
**1/2" power socket spanner insert**  
short



- Item No.**  
7716-121-410  
7716-121-411  
7716-121-412  
7716-121-413  
7716-121-414  
7716-121-415  
7716-121-416  
7716-121-417  
7716-121-418  
7716-121-419  
7716-121-421  
7716-121-422  
7716-121-424

08  
**1/2" power socket spanner insert**  
long



- Item No.**  
7716-121-510  
7716-121-511  
7716-121-512  
7716-121-513  
7716-121-514  
7716-121-515  
7716-121-516  
7716-121-517  
7716-121-518  
7716-121-519  
7716-121-521  
7716-121-522  
7716-121-524

Illustrations may differ from the original.



01

**1/2" screwdriver bit**  
Multi-tooth (XZN) 55 mm

**Item No.**

7716-125-005  
7716-125-006  
7716-125-008  
7716-125-009  
7716-125-010  
7716-125-012  
7716-125-014  
7716-125-016

02

**1/2" screwdriver bit**  
Multi-tooth (XZN) 100 mm

**Item No.**

7716-125-105  
7716-125-106  
7716-125-108  
7716-125-109  
7716-125-110  
7716-125-112  
7716-125-114

05

**1/2" screwdriver bit**  
Hexagon socket (Allen) 55 mm

**Item No.**

7716-122-005  
7716-122-006  
7716-122-007  
7716-122-008  
7716-122-010  
7716-122-012  
7716-122-014  
7716-122-017  
7716-122-019

06

**1/2" Schraubendreher-Einsatz**  
Hexagon socket (Inbus) 100 mm

**Item No.**

7716-122-105  
7716-122-106  
7716-122-107  
7716-122-108  
7716-122-110  
7716-122-111  
7716-122-112  
7716-122-113

03

**1/2" screwdriver bit**  
Multi-tooth (XZN) 140 mm

**Item No.**

7716-125-205  
7716-125-206  
7716-125-208  
7716-125-209  
7716-125-210  
7716-125-212  
7716-125-214

04

**1/2" screwdriver bit**  
Multi-tooth (XZN) 200 mm

**Item No.**

7716-125-308  
7716-125-310  
7716-125-312  
7716-125-314

07

**1/2" screwdriver bit**  
Hexagon socket (Inbus) 140 mm

**Item No.**

7716-122-205  
7716-122-206  
7716-122-207  
7716-122-208  
7716-122-210  
7716-122-212  
7716-122-214

08

**1/2" screwdriver bit**  
Hexagon socket (Inbus) 200 mm

**Item No.**

7716-122-305  
7716-122-306  
7716-122-307  
7716-122-308  
7716-122-310  
7716-122-312

01

**1/2" power socket spanner insert**

Double hexagon, 50 mm

Item No.	Key-width
7716-121-432	32 mm
7716-121-436	36 mm



04

**1/2" adapter**

\*\*\*???\* AGTB Standard:1



02

**1/2" socket spanner**

TORX® (T) 38 mm

Item No.
7716-123-010
7716-123-011
7716-123-012
7716-123-014
7716-123-016
7716-123-018
7716-123-020
7716-123-022
7716-123-024



05

**1/2" extension**

Item No.	length
7716-120-006	125 mm
7716-120-007	250 mm
7716-120-008	750 mm



03

**Slip Socket 1/2**

\*\*\*???\* AGTB Standard:1



06

**1/2 „adapter to 3/8“**► Item no. [7716-120-013](#)

06

**1/2" spark plug spanner**

66 mm

Item No.
7716-121-716
7716-121-721





01

**3/4 „socket wrench set**

20 pieces, drawer size L

► Item no. [7716-000-018](#)

You will find a detailed article description in the chapter „Tool assortments“ on page 46/47



02

**3/8“ adapter to 1/2**

External hexagon

Item No.	length
7716-341-019	50 mm
7716-341-021	50 mm
7716-341-022	50 mm
7716-341-023	50 mm
7716-341-024	50 mm
7716-341-026	50 mm
7716-341-027	52 mm
7716-341-028	52 mm
7716-341-030	54 mm
7716-341-032	56 mm
7716-341-034	58 mm
7716-341-036	58 mm
7716-341-038	60 mm
7716-341-041	64 mm
7716-341-046	68 mm
7716-341-050	68 mm



03

**3/8“ adapter to 1/4**

Item No.	length
7716-341-424	44 mm
7716-341-430	50 mm
7716-341-432	50 mm
7716-341-436	50 mm



04

**Side cutter**

Item No.	length
7716-340-002	100 mm
7716-340-003	200 mm
7716-340-004	400 mm



05

**3/4 „sliding handle**► Item no. [7716-340-005](#)

06

**3/4 „reversible ratchet**► Item no. [7716-340-001](#)

01

**1 „socket wrench insert**

Double hexagon

Item No.	length	Product description
7716-101-050	75 mm	
7716-101-055	80 mm	
7716-101-060	85 mm	
7716-101-065	87 mm	
7716-101-070	93 mm	
7716-101-080	103 mm	

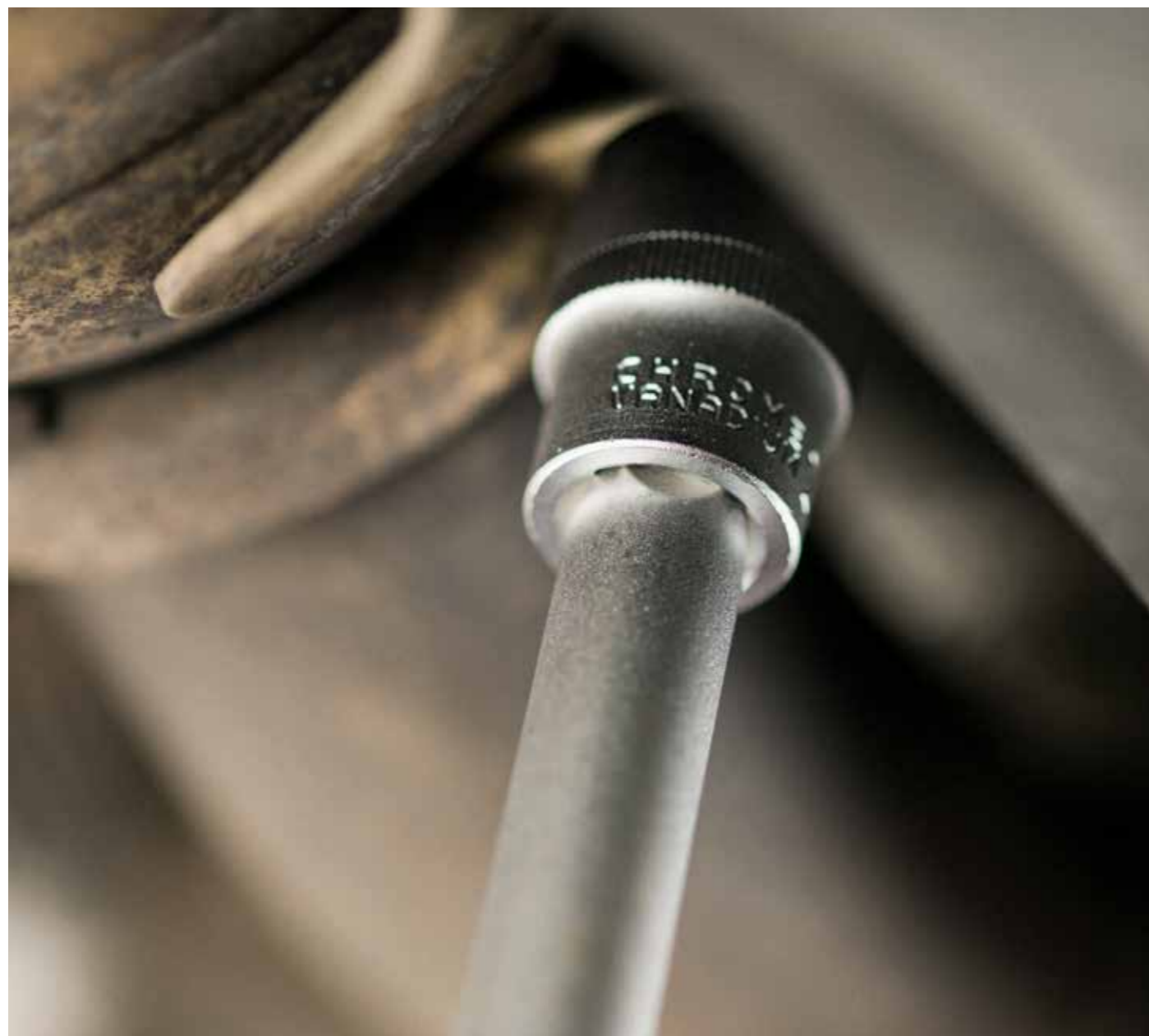

02

**1“ extension**

Item No.	length
7716-100-003	200 mm
7716-100-004	400 mm



03

**1 „sliding handle**▶ Item no. [7716-100-005](#)

04

**1 „slider**▶ Item no. [7716-100-002](#)

05

**1 „reversible ratchet**▶ Item no. [7716-100-001](#)*Illustrations may differ from the original.*



01

**Impact nuts**

5-piece, drawer size S

► Item no. [7716-000-026](#)



► 1/2 Impact nut, long

\*\*\*????\*\* AGTB Standard:1



02

**1/4", 3/8", 1/2" Anti Slip Nuts Set**

53-piece, drawer size M

► Item no. [7716-000-030](#)

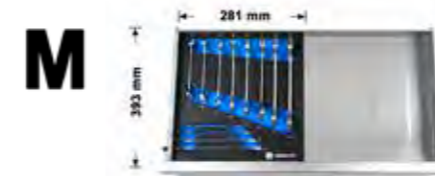

► Slip Socket 1/4  
\*\*\*????\*\* AGTB Standard:1

► Slip Socket 3/8  
\*\*\*????\*\* AGTB Standard:1

► Slip Socket 1/2  
\*\*\*????\*\* AGTB Standard:1

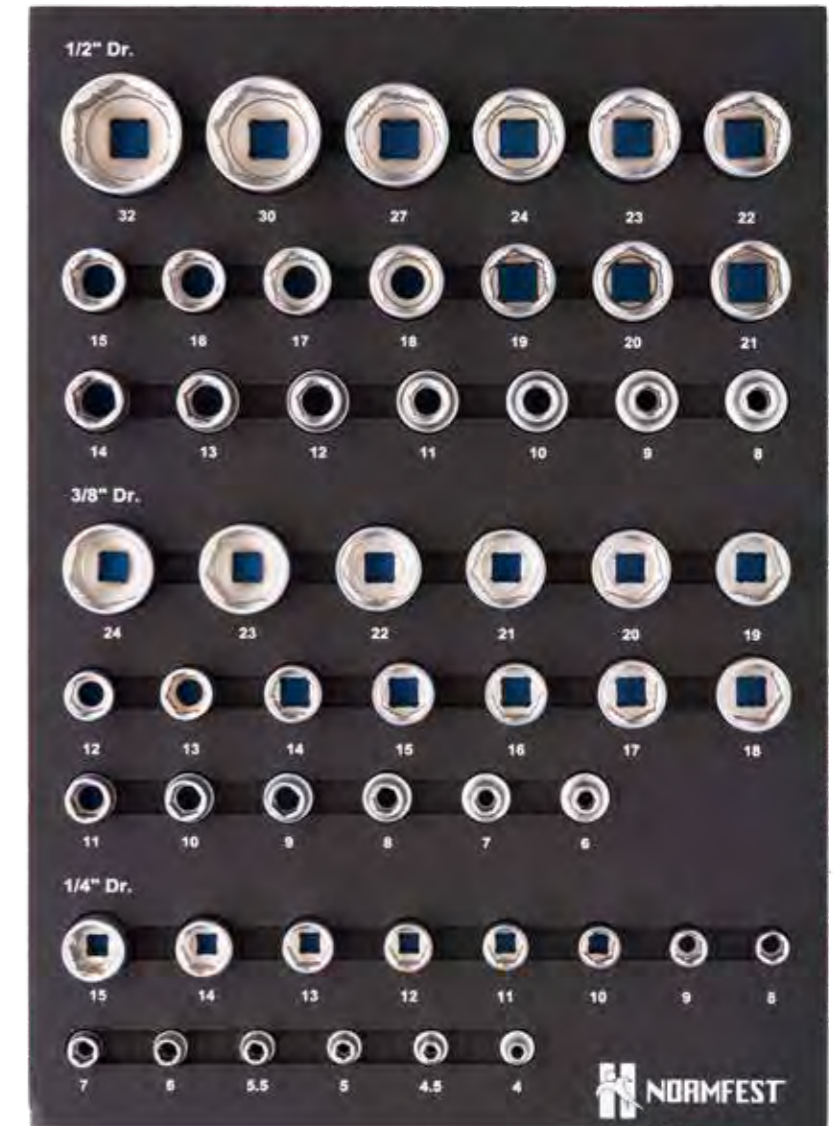







01

**Double open-end wrench**

Item No.	length
7716-206-7	125 mm
7716-208-9	140 mm
7716-210-11	155 mm
7716-212-13	170 mm
7716-214-15	185 mm
7716-216-17	205 mm
7716-218-19	215 mm
7716-220-22	230 mm
7716-221-23	240 mm
7716-224-27	255 mm
7716-225-28	280 mm
7716-230-32	290 mm

02

**Double open-end wrench set**

12 pieces, drawer size M

► Item no. [7716-000-008](#)*Illustrations may differ from the original.*

03

**Double ring spanner**  
deep cranked

Item No.	length
7716-106-7	175 mm
7716-108-9	190 mm
7716-110-11	205 mm
7716-112-13	220 mm
7716-114-15	245 mm
7716-116-17	270 mm
7716-118-19	295 mm
7716-120-22	315 mm
7716-121-23	340 mm
7716-124-27	350 mm
7716-125-28	355 mm
7716-130-32	365 mm

04

**Double ring spanner set**

11 pieces, drawer size M

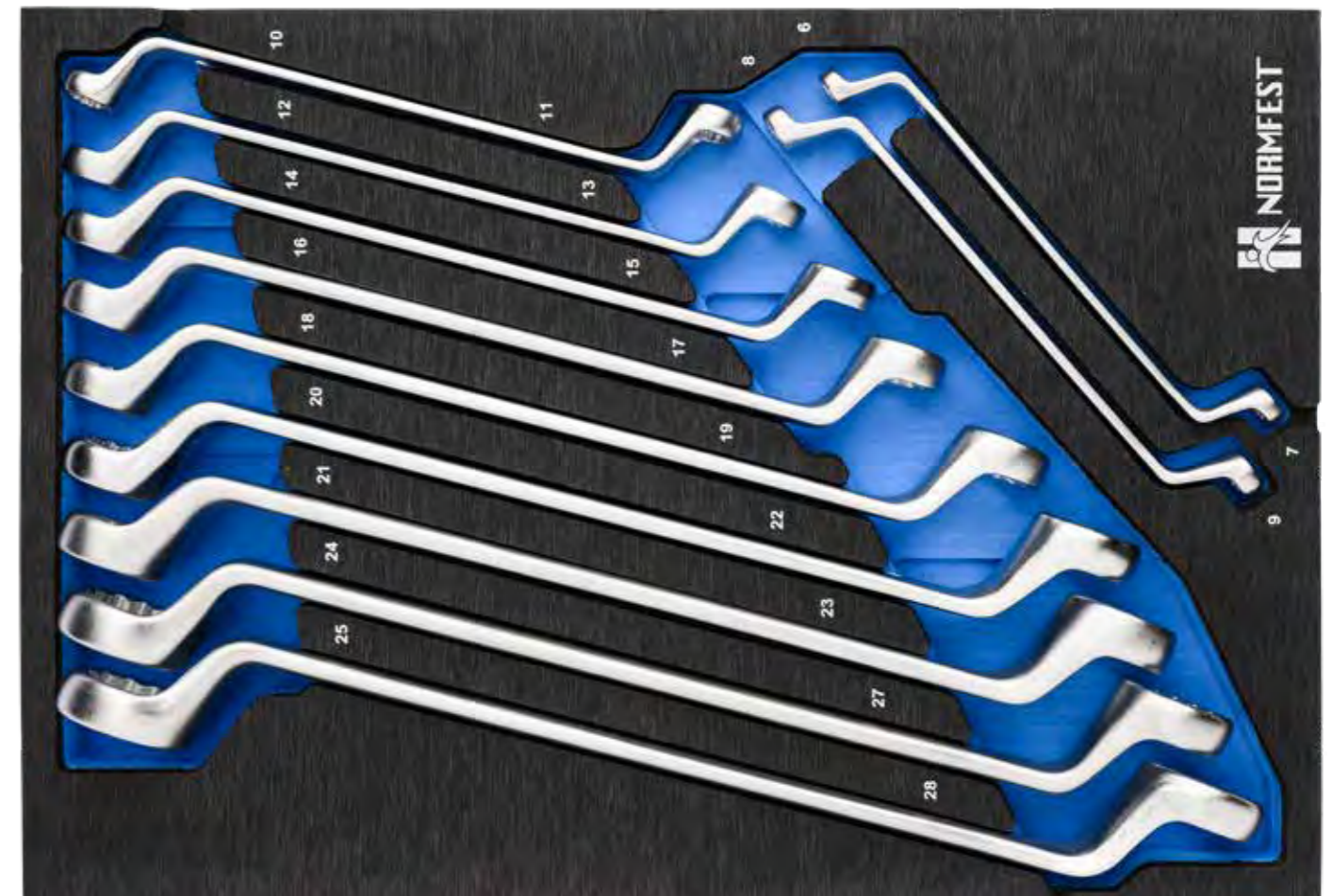
► Item no. [7716-000-009](#)



01

**Combination wrench**



Item No.	length
7716-300-6	105 mm
7716-300-7	115 mm
7716-300-8	125 mm
7716-300-9	135 mm
7716-300-10	145 mm
7716-300-11	155 mm
7716-300-12	165 mm
7716-300-13	175 mm
7716-300-14	185 mm
7716-300-15	195 mm
7716-300-16	205 mm
7716-300-17	215 mm
7716-300-18	225 mm
7716-300-19	230 mm
7716-300-20	245 mm
7716-300-21	285 mm
7716-300-22	265 mm
7716-300-24	285 mm
7716-300-27	310 mm
7716-300-30	345 mm
7716-300-32	365 mm
7716-300-36	410 mm



03

**Combination wrench set**

54 pieces, drawer size XL

► Item no. [7716-000-003](#)

02

**Combination wrench set**

17 pieces, drawer size M

► Item no. [7716-000-010](#)



**M**

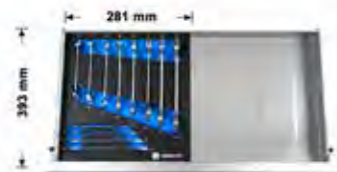

**XL**

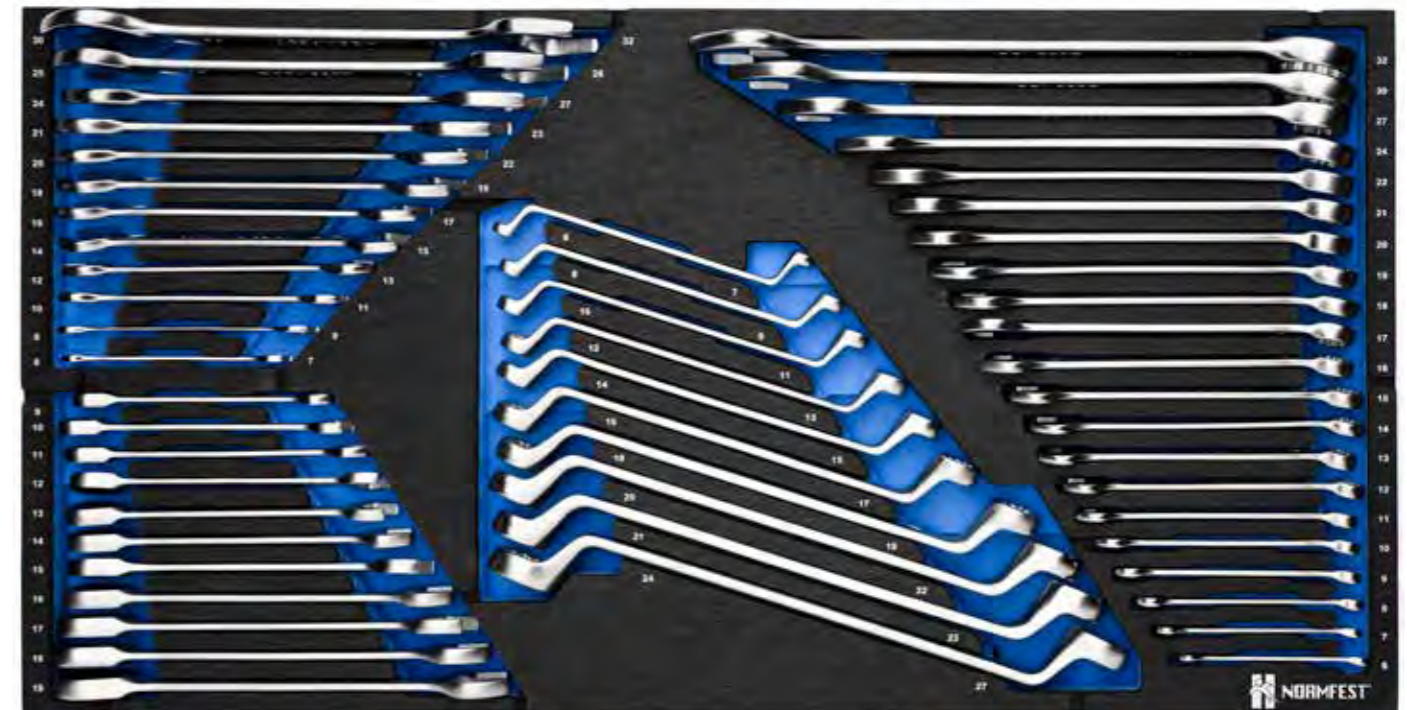
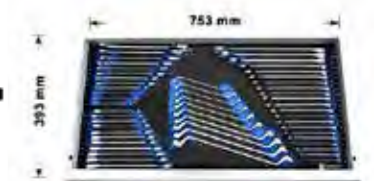

Illustrations may differ from the original.



01

**Ratchet combination wrench**

Item No.	length
7716-400-9	140 mm
7716-400-10	160 mm
7716-400-11	170 mm
7716-400-12	175 mm
7716-400-13	180 mm
7716-400-14	185 mm
7716-400-15	200 mm
7716-400-16	230 mm
7716-400-17	225 mm
7716-400-18	235 mm
7716-400-19	245 mm



02

**Ratchet combination wrench set**

44-part drawer size L

► Item no. [7716-000-017](#)

03

**Articulated ratchet combination wrench**

Item No.	length
7716-500-8	135 mm
7716-500-9	140 mm
7716-500-10	160 mm
7716-500-11	165 mm
7716-500-12	170 mm
7716-500-13	180 mm
7716-500-14	185 mm
7716-500-15	200 mm
7716-500-16	210 mm
7716-500-17	225 mm
7716-500-18	235 mm
7716-500-19	245 mm
7716-500-21	285 mm



04

**Articulated ratchet combination wrench set**

13 pieces, drawer size M

► Item no. [7716-000-014](#)

Illustrations may differ from the original.





01

**Aul ring ratchet 15°**

\*\*\*???\* AGTB Standard:1

02

**Key phrase**

37-part drawer size L

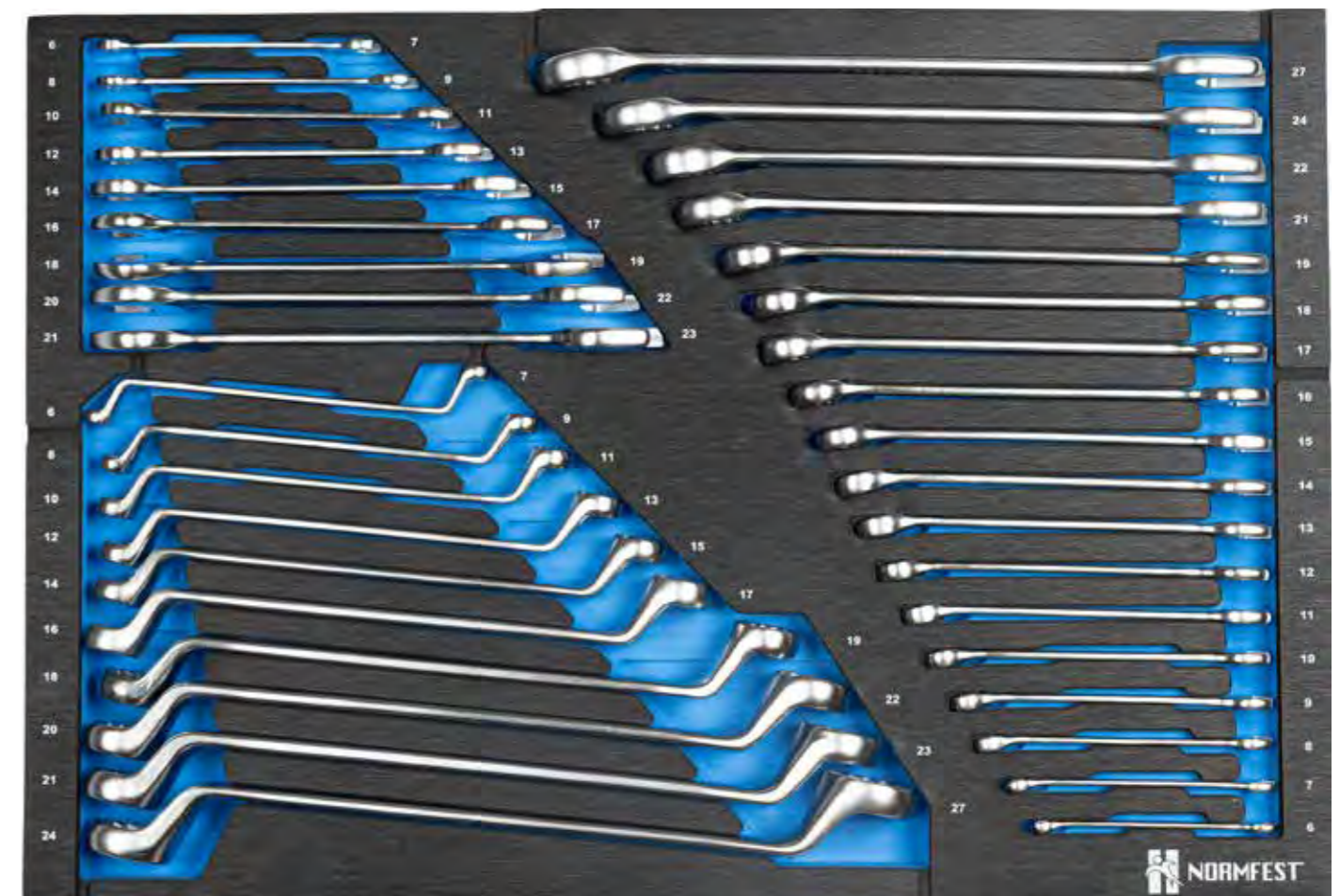
▶ [Item no. 7716-000-001](#)*Illustrations may differ from the original.*



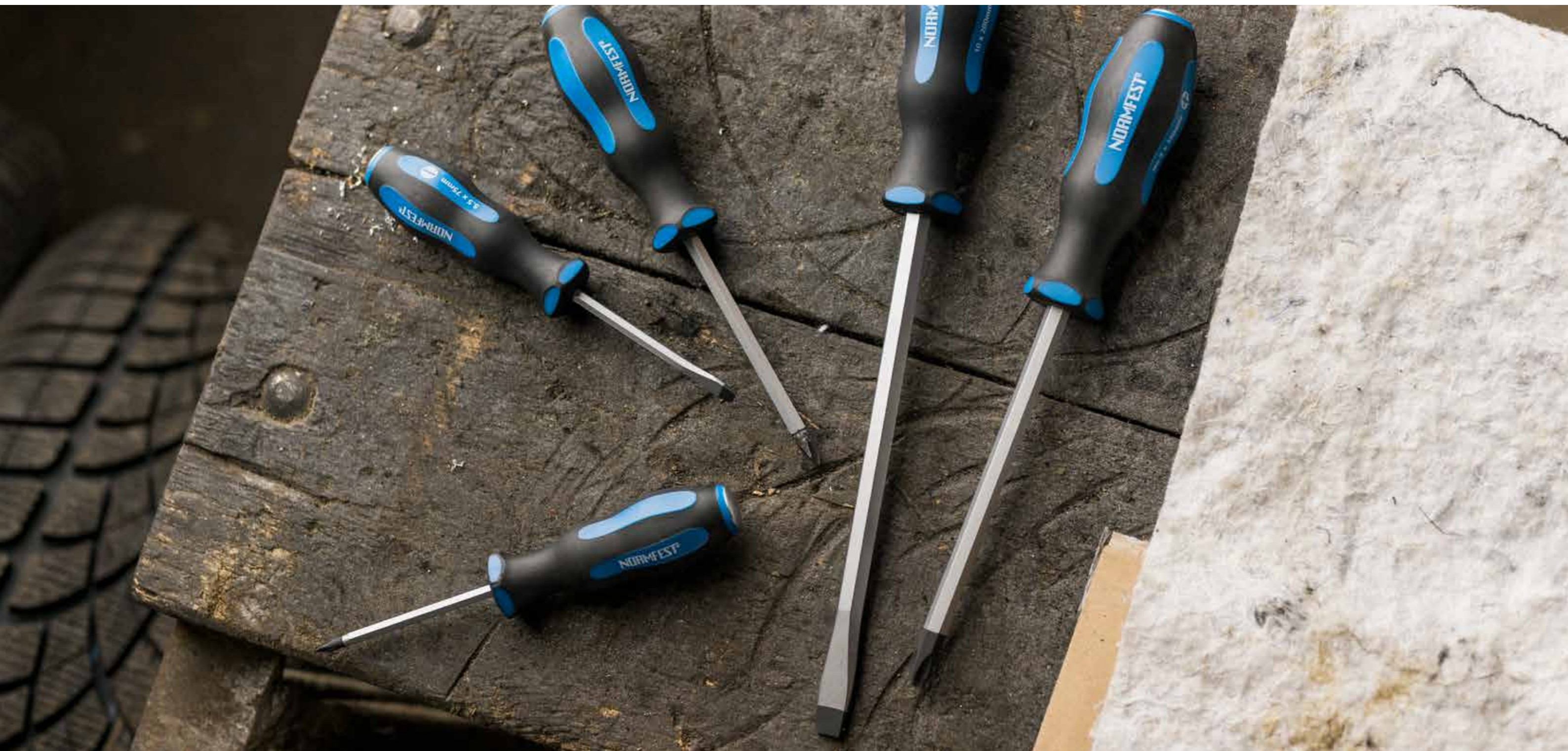



01  
**Slotted screwdriver**

Item No.	Blade length	Blade width
7716-020-10	75 mm	3 mm
7716-020-14	100 mm	4 mm
7716-020-7	4.5 mm	5.5 mm
7716-020-6	150 mm	6.5 mm
7716-020-9	150 mm	8 mm
7716-020-13	200 mm	10 mm



02  
**Phillips screwdriver**

\*\*\*???\* AGTB Standard:1



03  
**Slotted screwdriver**  
short 97 mm

► Item no. [7716-020-15](#)



04  
**Phillips screwdriver**  
short 97 mm

► Item no. [7716-020-11](#)



Illustrations may differ from the original.



05  
**Offset screwdriver**

Item No.	Blade length	Blade width
7716-020-21	75 mm	5 mm
7716-020-18	100 mm	6 mm
7716-020-22	6 X 150 mm	8 mm
7716-020-19	6 X 150 mm	10 mm



06  
**1/4" solid steel reversible ratchet, long version**



Item No.
7716-020-20
7716-020-17
7716-020-16



01

**TORX® screwdriver****Item No.**

7716-020-39  
7716-020-40  
7716-020-41  
7716-020-42  
7716-020-43  
7716-020-44  
7716-020-45  
7716-020-46  
7716-020-47  
7716-020-48  
7716-020-49

02

**T- / L-handle screwdriver set**

16 pieces, drawer size L

▶ [Item no. 7716-000-024](#)

Illustrations may differ from the original.

03

**Outside hexagon screwdriver**

T-handle

**Item No.**

7716-020-25  
7716-020-23  
7716-020-24  
7716-020-33  
7716-020-34  
7716-020-35  
7716-020-36  
7716-020-37  
7716-020-38  
7716-020-38

**Width across flats**

8x150 mm  
6x150 mm  
7x150 mm  
6x230 mm  
7x230 mm  
8x230 mm  
10x230 mm  
12x230 mm  
13x230 mm  
13x230 mm



04

**Hexagon socket screwdriver**

L-handle

▶ [Product description](#)

- with ball head and Allen key



\*\*\*???\* AGTB Standard:1

05

**Flexible screwdriver**

Outside hexagon profile

**Art.-Nr.**

7716-020-23  
7716-020-24  
7716-020-25

**Schlüsselweite**

6x150 mm  
7x150 mm  
8x150 mm



06

**Allen key screwdriver****Item No.**

7716-020-3  
7716-020-1  
7716-020-50  
7716-020-2

**length**

40 mm  
46 mm  
51 mm  
51 mm





01

**Screwdriver set**

12 pieces, drawer size M

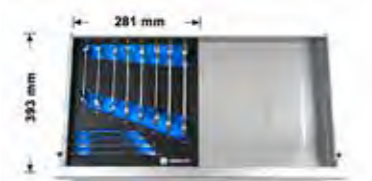
► Item no. [7716-000-011](#)**M**

03

**TORX screwdriver set**

11 pieces, drawer size M

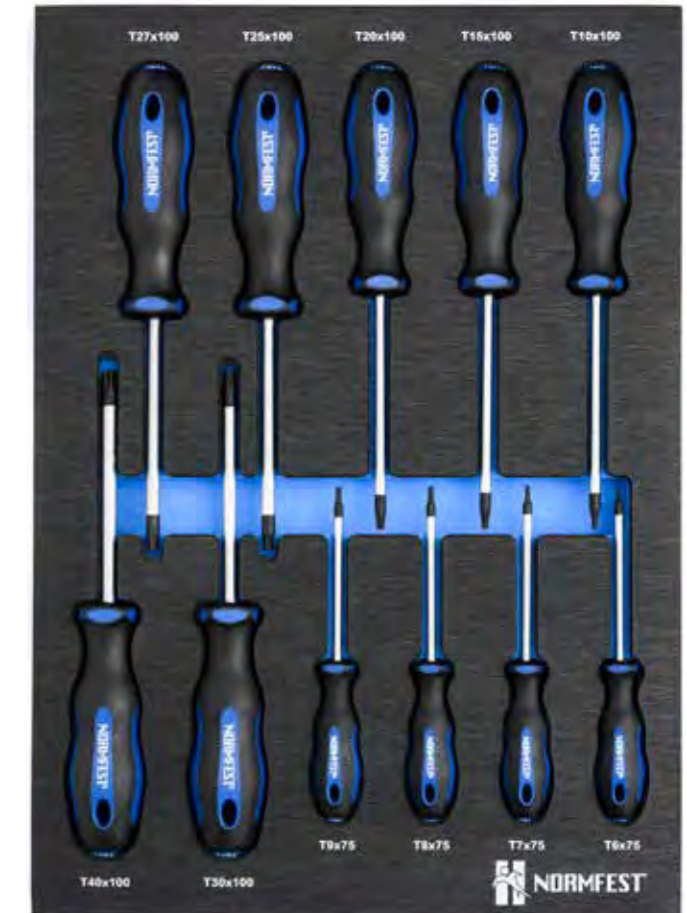
► Item no. [7716-000-021](#)**M**

02

**Impact screwdriver set**

7 pieces, drawer size M

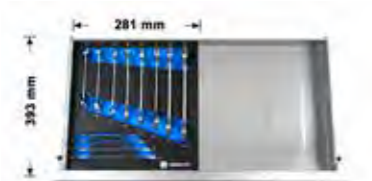
► Item no. [7716-000-013](#)**M**

04

**Electronics screwdriver set**

6 pieces

► Item no. [7716-000-020](#)*Illustrations may differ from the original.*





Packing tapes



01

**Pliers for retaining rings**  
for shafts of 10-25 mm

► Item no. [7716-030-8](#)

► Product description  
- Total length 240 mm  
- Pin diameter 1.3 mm



03

**Pliers for retaining rings**  
for bores of 12-25 mm

► Item no. [7716-030-7](#)

► Product description  
- Total length 240 mm  
- Pin diameter 1.3 mm



02

**Pliers for retaining rings**  
for shafts from 19-60 mm

► Item no. [7716-030-5](#)

► Product description  
- Total length 240 mm  
- Pin diameter 2 mm



04

**Pliers for retaining rings**  
for bores from 19-60 mm

► Item no. [7716-030-6](#)

► Product description  
- Total length 240 mm  
- Pin diameter 2 mm



05

**Pliers for retaining rings**  
for shafts from 40-100 mm

► Item no. [7716-030-10](#)

► Product description  
- Total length 240 mm  
- Pin diameter 2.5 mm

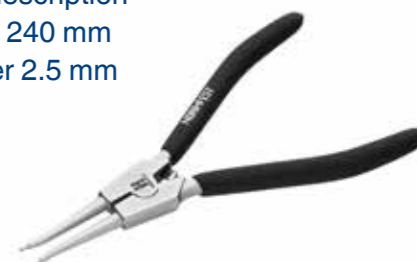

06

**Pliers for retaining rings**  
for bores from 40-100 mm

► Item no. [7716-030-9](#)

► Product description  
- Total length 240 mm  
- Pin diameter 2.5 mm



07

**Set of gripping pliers**  
3-piece, drawer size S

► Item no. [7716-000-025](#)

S



► **Grip pliers**

\*\*\*???\* AGTB Stan-  
dard:1





01

**Needle nose pliers**

200 mm

▶ Item no. [7716-030-1](#)

03

**Combination pliers**

180 mm

▶ Item no. [7716-030-2](#)

02

**Side cutter**

160 mm

▶ Item no. [7716-030-3](#)

04

**Water pump pliers**

250 mm

▶ Item no. [7716-030-4](#)*Illustrations may differ from the original.*

## Packing tapes

05

**Set of pliers**

4-part, drawer size M

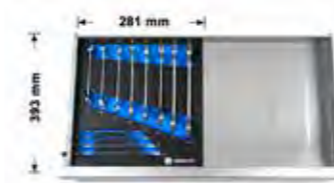
▶ Item no. [7716-000-019](#)**M**

06

**Safety pliers set**

6 parts, drawer size M

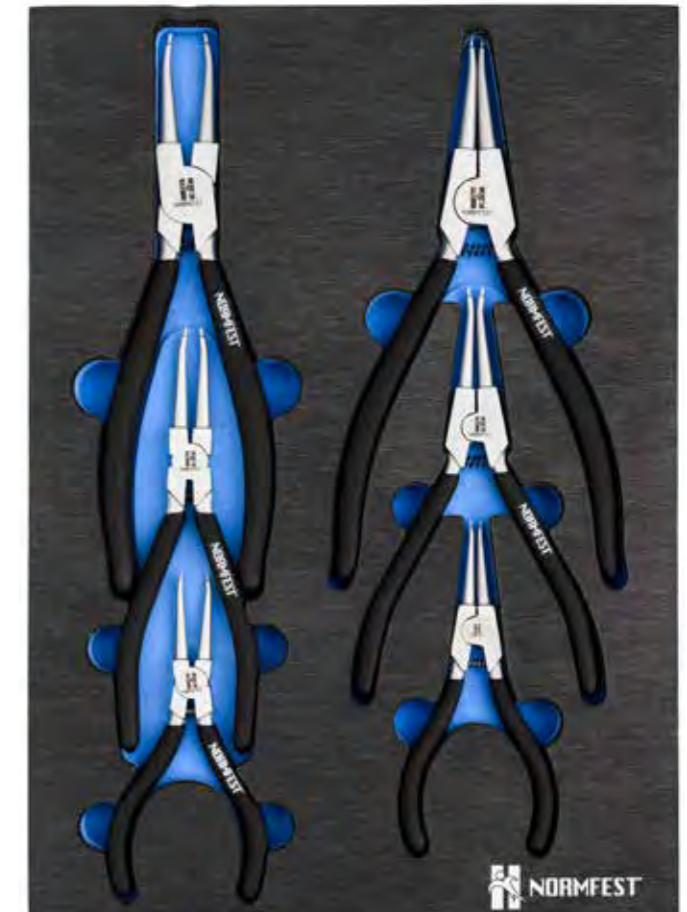
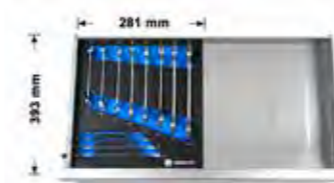
▶ Item no. [7716-000-012](#)**M**









01

**Pin punch**

150 mm

Item No.	width
7716-040-10	2 mm
7716-040-3	3 mm
7716-040-7	4 mm
7716-040-11	5 mm
7716-040-4	6 mm
7716-040-8	8 mm



02

**Hammer, chisel and pin punch set**

11 pieces, drawer size M

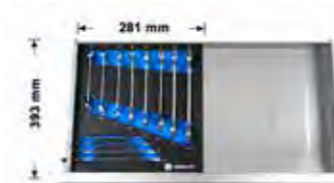
► Item no. [7716-000-022](#)**M***Illustrations may differ from the original.*



01

**Flat chisel**  
18 x 150 mm

► Item no. [7716-040-1](#)



02

**Cross chisel**  
6 X 150 mm

► Item no. [7716-040-5](#)



03

**Grains**  
10 x 120 mm

► Item no. [7716-040-2](#)



04

**Engineer's hammer**

► Item no. [7716-040-6](#)

► Product description  
- Length: 310 mm  
- Weight: 800 grams



05

**Plastic hammer**

► Item no. [7716-040-9](#)

► Product description  
- Length: 310 mm







 DEUTSCHLAND

Normfest GmbH  
Siemensstr. 23  
D-42551 Velbert  
Tel.: +49 2051 275 - 0  
Fax: +49 2051 275 - 141  
E-mail: info@normfest.de  
www.normfest.com  
www.normfest-shop.com



 OUR BUSINESS DIVISIONS

Normfest GmbH  
dress & safe  
Im Lipperfeld 9  
D-46047 Oberhausen  
Tel.: +49 208 60 70 - 100  
Fax: +49 208 60 70 - 190  
E-mail: info@dress-safe.de  
www.dress-safe.de

**dress & safe**

Normfest GmbH  
CODESI  
Siemensstr. 23  
D-42551 Velbert  
Tel.: +49 2051 275 - 200  
Fax: +49 2051 275 27 - 200  
E-mail: info@codesi.de  
www.codesi.de



 POLEN

Normfest Polska Sp. z o.o.  
ul. Wichrowa 4 / 10  
PL-60-449 Poznań  
Tel.: +48 61 8 439 140  
Fax: +48 61 8 439 142  
E-mail: info@normfest.pl  
www.normfest.pl  
www.normfest-shop.pl

 TSCHECHIEN

Normfest s.r.o.  
Pekařská 603/12  
CZ-155 00, Praha 5  
Tel.: +420 257 013 280  
Fax: +420 257 013 281  
E-mail: info@normfest.cz  
www.normfest.cz  
www.normfest-shop.cz

WE ARE PRESENT IN THE FOLLOWING COUNTRIES THROUGH OUR SPECIALISED TRADE PARTNERS:

 ITALIEN

SCAR Srl

via Caduti sul Lavoro, 25  
I-37012 | Bussolengo (VR)  
Tel.: +39 045 676 8311  
Fax: +39 045 676 8400  
E-mail: info@scar.it  
www.scar.it



 ITALIEN

FIME Srl

Largo Leonardo da Vinci,  
8 I-37050 | Belfiore (VR)  
Tel.: +39 045 613 4211  
Fax: +39 045 676 4200  
E-mail: info@fimesrl.it  
www.fimesrl.it



 ÖSTERREICH

Kellner & Kunz AG

Boschstr. 37  
A-4600 Wels  
Tel.: +43 7242 484 0  
Fax: +43 7242 484 929  
E-mail: info@reca.co.at  
www.reca.co.at



 SPANIEN

RECA Hispania S.A.U.

C/ Ciudad de Llíria nº21  
Pol. Ind. Fuente del Jarro  
ES-46988 Paterna-Valencia  
Tel.: +34 902 73 40 22  
Fax: +34 902 73 40 46  
E-mail: info@recahispania.com  
www.es.reca.com



 SLOWAKEI

RECA Slovensko s.r.o.

Vajnorská 134 / B  
SK-831 04 Bratislava  
Tel.: +421 2 444 55 916 8  
Fax: +421 2 444 55 900  
E-mail: reca@reca.sk  
www.reca.sk



 KROATIEN

RECA d.o.o.  
Kučanska 23  
HR-42000 Varaždin  
Tel.: +385 42 350 - 813  
Fax: +385 42 350 - 818  
E-mail: recadoo@reca.co.at  
www.reca.hr



 BOSNIEN HERZEGOWINA

RECA d.o.o.  
Vijci, alati i normirani elementi  
Hifzi Bjelevca 11A  
BIH-71210 Ilidža - Sarajevo  
Tel.: +387 33777 720  
Fax: +387 33789 520  
E-mail: reca@reca.ba  
www.reca.ba

