

New products for machining technicians

NEW Polygon system extension



Milling insert for part-off

→ Page 15

- ▲ Reliable cutting with groove depths up to 11.5 mm in almost all materials
- ▲ Longest service lives with maximum process security
- ▲ Different diameters with groove width of 1.5 mm available from stock



Thread milling insert partial profile

→ Page 16

- ▲ Extension of the existing 50 882 range to include the thread pitch 3.5 – 6 mm

NEW MiniMill XL multipurpose milling system



Milling insert

→ Page 28

Tool holder

→ Page 33

- ▲ Extension of the tried-and-tested MiniMill multipurpose milling system \varnothing 37 mm by \varnothing 50 mm
- ▲ Reliable cutting with groove depths up to 16.5 mm in almost all materials
- ▲ Cross-pitched versions for significantly greater self-cleaning effect with lower chip jamming tendency
- ▲ Wide range of groove widths and holders available from stock

NEW Shank thread milling cutter type SFSE



→ Page 65–67

- ▲ Multi-row shank thread milling cutter with countersink cutting edge
- ▲ Universal application in almost all materials
- ▲ 2-in-1 tool: thread milling and countersinking with a single tool
- ▲ Maximum reliability and process security
- ▲ Unsurpassed price-performance ratio

NEW Shank thread milling cutter type SGF



→ Page 71–74

- ▲ Multi-row shank thread milling cutter
- ▲ Universal application in almost all materials
- ▲ Maximum reliability and process security
- ▲ Unsurpassed price-performance ratio

NEW Shank thread milling cutter type HR

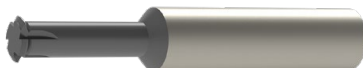

→ Page 60

- ▲ Single-row shank thread milling cutter with universal application, but with focus on hard machining
- ▲ Outstanding solution for high lateral forces during machining → absolutely cylindrical, true-to-gauge and dimensionally accurate threads of the highest quality



Solid drilling and bore machining

- 1 HSS drilling
- 2 Solid carbide drilling
- 3 Indexable insert drilling
- 4 Reaming and Countersinking
- 5 Spindle Tooling

Threading

- 6 Taps and thread formers
- 7 Circular and Thread Milling
- 8 Thread turning

Turning

- 9 Turning Tools
- 10 Multifunctional Tools – EcoCut and FreeTurn
- 11 Grooving Tools
- 12 Miniature turning tools

Milling

- 13 HSS Milling Cutters
- 14 Solid Carbide milling cutters
- 15 Milling tools with indexable inserts

Clamping technology

- 16 Adaptors and Accessories
- 17 Workpiece clamping

- 18 Material examples

Table of contents

Symbol explanation	4
Tool types	5
Overview Circular and Thread Milling Cutters	5
Thread types	6
Process description	6+7
Toolfinder	8+9
Product programme	10-74
Technical Information	
Cutting Data	75-81
Milling processes (climb milling and conventional milling)	82
Feed rate calculation	82
Calculation of cutting data for thread milling	83
Coatings	83

WNT \ Performance

Premium quality tools for high performance.

The premium quality tools from the **WNT Performance** product line have been designed for specific applications and are distinguished by their outstanding performance. If you make high demands on the performance of your production and want to achieve the very best results, we recommend the Premium tools in this product line.





WNT \ Standard

Quality tools for standard applications.



The quality tools of the **WNT Standard** product line are high quality, powerful and reliable and enjoy the highest trust of our customers worldwide. Tools from this product line are the first choice for many standard applications and guarantee optimal results.

Symbol explanation

Version

-  no drilling required
-  central internal coolant
-  Radial thro' coolant
-  Coolant supply either via the flange or centrally
-  left-hand cutting



Shank

-  Plain cylindrical shank
-  Cylindrical shank with lateral driving face „Weldon“









- = Main Application
- = Extended application



Thread / Flank angle

-  Explanation of the types of thread can be found on → **Page 6.**
-  Flank angle 60°

Applications

-  Circlip Grooves
-  Full radius slot milling
-  Slot milling
-  Multipurpose milling
-  Chamfering and Deburring
-  Internal R L
-  External R L
-  Internal/External R L

Tool types

System 300	Circular milling cutter with solid carbide insert	BGF	Solid carbide drill thread milling cutter
Polygon	Circular shank milling cutter with carbide indexable insert (polygon insert seat)	Micro Mill	Solid Carbide Circular End Milling Cutter
Mini Mill	Circular milling cutter with solid carbide milling insert (with three-rib insert connection)	ZBGF	Solid carbide circular drill thread milling cutter
MWN	Multi-tooth thread milling cutter with carbide indexable inserts (straight insert seat) and Weldon flat	SGF	Thread milling cutter
GZD	Multi-tooth thread milling cutter with carbide indexable inserts (angled insert seat) and Weldon flat	SFSE	Thread milling cutter with chamfer facet
GZG	Multi-tooth thread milling cutter with carbide indexable inserts (straight insert seat) and Weldon flat	SFSE Micro	Thread milling cutter for smallest threads
EAW	Single-row thread milling cutter with carbide indexable inserts and Weldon flat	HR	Single-row shank thread milling cutter
EWM	Single-row thread milling cutter with carbide indexable insert and SK adapter		

7

Overview Circular and Thread Milling Cutters

Modular Circular Milling Cutters with Carbide Indexable Inserts (ModuSet)

- ▲ the perfect tool for every application
- ▲ various holders, depending on overhang
- ▲ the same threading insert for different pitches and diameters
- ▲ highest flexibility and stability
- ▲ in addition to circular thread milling, circular and linear milling operations can also be carried out

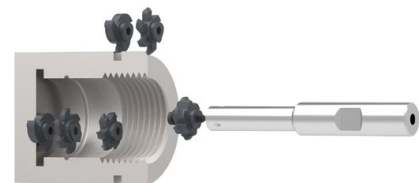

1st choice for small batch sizes and large threads

Thread Milling Cutters with Indexable Carbide Inserts (ModuThread)

- ▲ exchange of the insert for different threads
- ▲ same threading insert for different diameters



Solid Carbide Thread Milling Cutters (MonoThread)

- ▲ short machining times, ideal for volume production
- ▲ one tool for all thread types
- ▲ one thread milling cutter for different diameters with the same pitch



MicroMill



SGF



ZBGF



BGF

Thread types

M	Metric ISO standard thread	BSW	Whitworth thread
MF	Metric ISO fine thread	BSF	Whitworth fine thread
G	Whitworth pipe thread	NPT	American taper pipe thread
UN	Unified thread	Pg	Steel conduit thread
UNC	Unified Standard Thread	Tr	Trapezoidal thread
UNF	Unified fine thread		

Thread milling process description

Thread milling

- ▲ Cutting
- ▲ Thread production by circular milling in the pitch (helical interpolation)
- ▲ Can be used for a wide range of materials up to 60 HRC
- ▲ Lower torque than taps and thread formers (no reversing of the spindle necessary)
- ▲ Thread machining to the bottom of the hole possible
- ▲ High-speed cutting (HSC) can be performed

Advantages of thread milling

- ▲ Different tolerances can be produced with one tool
- ▲ One tool for blind hole and through hole machining
- ▲ Outstanding workpiece surfaces and dimensional accuracy guaranteed
- ▲ One tool for right and left-hand threads
- ▲ Low cutting pressure when machining thin-walled parts
- ▲ Precisely repeatable thread depth
- ▲ No chip issues and no chip root residues in the finished thread

Added advantages of thread milling cutters with chamfer facet

- ▲ Savings in tool change and setup times, resulting in significantly shorter machining times
- ▲ Optimisation of magazine assignment in the machine

Process

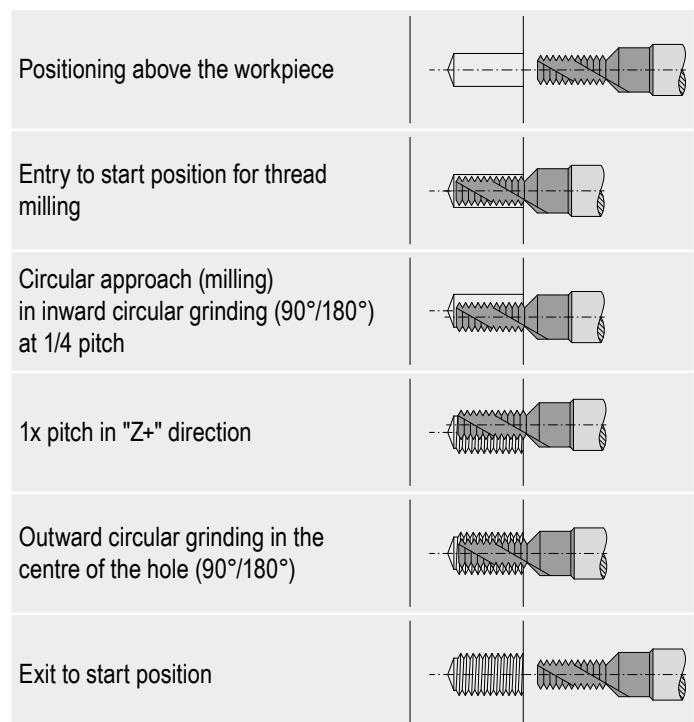

Climb milling is shown here. Further information on the milling processes (climb and conventional milling) can be found on → **page 82**.

Description of procedure, thread milling cutters

Thread milling

- ▲ Cutting
- ▲ Production of a complete thread – drilling, countersinking and thread milling with just one tool
- ▲ Can be used in different materials (K/N)
- ▲ Prerequisite: CNC-controlled milling machine or machining centre with the helical interpolation function

Advantages

- ▲ Shortest machining times thanks to high cutting speeds and feeds
- ▲ Savings in tool change and setup times, resulting in significantly shorter machining times
- ▲ Optimisation of magazine assignment in the machine
- ▲ Different tolerances can be produced with one tool
- ▲ Outstanding workpiece surfaces and dimensional accuracy guaranteed
- ▲ One tool for blind hole and through hole machining
- ▲ Precisely repeatable thread depth
- ▲ No chip issues and no chip root residues in the finished thread
- ▲ High-speed cutting (HSC) can be performed

Process

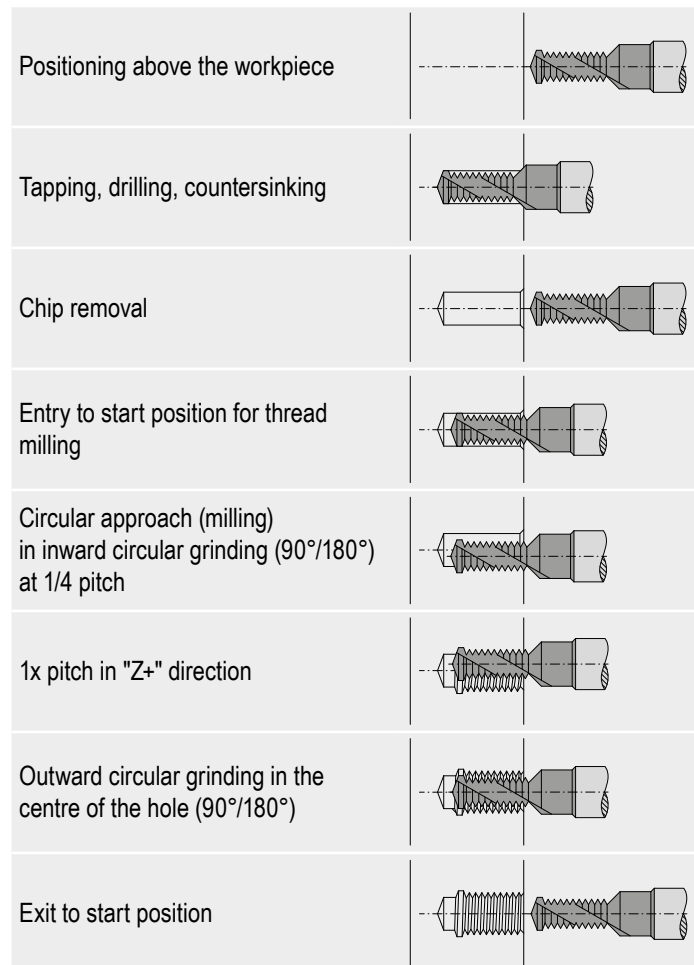

Circular drill thread milling cutter

- ▲ Cutting
- ▲ Production of a complete thread – drilling, countersinking and thread milling with just one tool
- ▲ Can be used in different materials (H/S/O)
- ▲ Prerequisite: CNC-controlled milling machine or machining centre with the helical interpolation function

Advantages





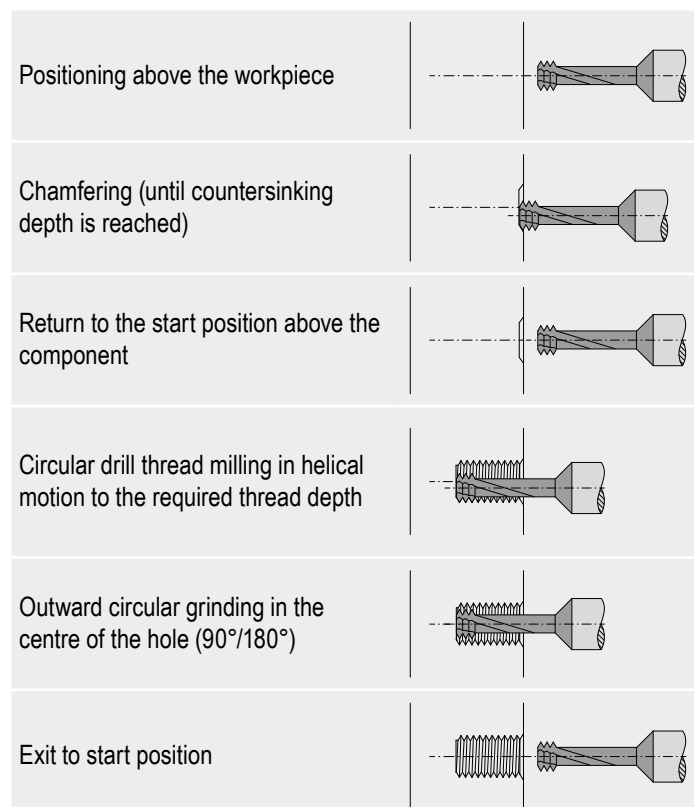









- ▲ Shortest machining times due to simultaneous creation of the tap hole and thread
- ▲ Savings in tool change and setup times, resulting in significantly shorter machining times
- ▲ Optimisation of magazine assignment in the machine
- ▲ Different tolerances can be produced with one tool
- ▲ Outstanding workpiece surfaces and dimensional accuracy guaranteed
- ▲ One tool for blind hole and through hole machining
- ▲ Precisely repeatable thread depth
- ▲ Optimum chip removal and no chip root residues in the finished thread

Process



Toolfinder

						from bore diameter in mm
ModuSet	Modular Circular Milling Cutters with Carbide Indexable Inserts	Polygon		<ul style="list-style-type: none"> ▲ high power transmission through polygon connection ▲ 3 and 6 edged inserts ▲ stable holders in solid carbide and steel 	9,6	
		Mini Mill		<ul style="list-style-type: none"> ▲ three interlocking rib location ▲ compatible with popular manufacturer systems ▲ 3 and 6 edged inserts ▲ stable holders in solid carbide and steel 	9,8	
		System 300		<ul style="list-style-type: none"> ▲ proven circular milling tool ▲ 3 edged inserts 	10,6	
ModuThread	Thread Milling Cutters with Indexable Carbide Inserts	MWN		<ul style="list-style-type: none"> ▲ multi tooth thread milling cutter ▲ double sided inserts ▲ exclusively for thread production ▲ holder for tapered threads 	9,0	
		GZD		<ul style="list-style-type: none"> ▲ multi tooth drilling and thread milling cutter ▲ for thread milling in solid material ▲ core hole and thread with one tool 	14,0	
		GZG		<ul style="list-style-type: none"> ▲ multi tooth thread milling cutter ▲ exclusively for thread production 	18,5	
		EAW		<ul style="list-style-type: none"> ▲ single-row thread milling cutter ▲ inserts with 2 or 4 cutting edges ▲ exclusively for production of the thread ▲ insert holder with cylindrical shank DIN 1835 	17,5	
		EWM		<ul style="list-style-type: none"> ▲ single-row thread milling cutter ▲ inserts with 4 cutting edges ▲ exclusively for production of the thread ▲ monoblock insert holder with steep taper DIN 69871 	43,0	
MonoThread	Solid Carbide Thread Milling Cutters	Micro Mill		<ul style="list-style-type: none"> ▲ solid carbide circular milling cutter for small diameters 	1,25	
		BGF		<ul style="list-style-type: none"> ▲ drill thread milling cutter ▲ core hole, countersink, thread and thread undercut with one tool 	2,45	
		ZBGF		<ul style="list-style-type: none"> ▲ circular drill thread milling cutter ▲ core hole, countersink and thread with one tool 	2,3	
		SFSE Micro		<ul style="list-style-type: none"> ▲ solid carbide shank thread milling cutter with chamfer facet ▲ just one tool for countersink and thread ▲ specially developed for the smallest threads in hard materials 	0,75	
		SFSE		<ul style="list-style-type: none"> ▲ solid carbide thread milling cutter with chamfering facet ▲ only one tool for threading and chamfering 	3,14	
		SGF		<ul style="list-style-type: none"> ▲ solid carbide thread milling cutter without chamfering facet ▲ exclusively for thread production 	1,53	
		HR		<ul style="list-style-type: none"> ▲ single-row shank thread milling cutter ▲ exclusively for production of the thread ▲ up to 3xD in materials up to 60 HRC 	3,14	

Thread / Flank angle									Applications					Tool holder
														
M	G	BSW	UN	UNC	Pg	NPT	Tr							
MF		BSF		UNF										
16+17	18	18		20				19	10+11	12+13	14	14	15	21
29+30	30								22	23+24 25	24	26	27+28	31-33
37	38	38							34+35	36		36		39
40	41		41		42	42								43+44
45	45													46
47	48		49		48									50
51	51		51											52
53			53											54
56										55		55		
57+58														
59														
61														
62+63	64			67		64								
65	66					66								
68+69	70													
71	72	72		73										
74														
60														

ModuSet – Milling inserts for circlip grooves without chamfer

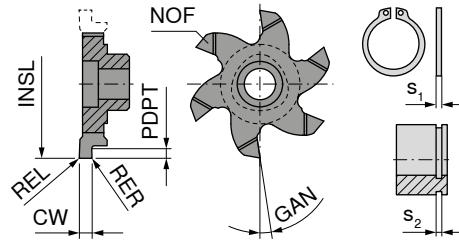

Ti500



Solid carbide

50 880 ...

Size	s ₂ H13 mm	INSL mm	CW _{-0.03} mm	PDPT mm	REL mm	RER mm	GAN °	s ₁ mm	NOF	
6	0,90	9,6	0,98	1,20	0,05	0,05	6	0,80	3	292
	1,10	11,7	1,18	1,00	0,05	0,05	6	1,00	3	294
	1,30	11,7	1,38	1,00	0,05	0,05	6	1,20	3	296
	1,60	11,7	1,68	1,00	0,10	0,10	6	1,50	3	298
7	1,10	16,0	1,18	0,90	0,05	0,05	6	1,00	6	301
	1,30	16,0	1,38	1,10	0,05	0,05	6	1,20	6	302
	1,60	16,0	1,68	1,25	0,10	0,10	6	1,50	6	304
	1,85	16,0	1,93	1,25	0,10	0,10	6	1,75	6	306
	1,10	17,7	1,18	0,90	0,05	0,05	6	1,00	6	308
	1,30	17,7	1,38	1,10	0,05	0,05	6	1,20	6	309
	1,60	17,7	1,68	1,25	0,10	0,10	6	1,50	6	310
	1,85	17,7	1,93	1,25	0,10	0,10	6	1,75	6	311
9	1,10	20,0	1,18	0,90	0,05	0,05	6	1,00	6	313
	1,30	20,0	1,38	1,10	0,05	0,05	6	1,20	6	314
	1,60	20,0	1,68	1,25	0,10	0,10	6	1,50	6	315
	1,85	20,0	1,93	1,25	0,10	0,10	6	1,75	6	316
	1,60	21,7	1,68	1,25	0,10	0,10	6	1,50	6	318
	1,85	21,7	1,93	1,25	0,10	0,10	6	1,75	6	319
	2,15	21,7	2,23	1,75	0,10	0,10	6	2,00	6	320
	2,65	21,7	2,73	1,75	0,20	0,20	6	2,50	6	321
10	1,30	26,0	1,38	1,10	0,05	0,05	6	1,20	6	322
	1,60	26,0	1,68	1,25	0,10	0,10	6	1,50	6	324
	1,85	26,0	1,93	1,25	0,10	0,10	6	1,75	6	326
	2,15	26,0	2,23	1,75	0,10	0,10	6	2,00	6	328
	2,65	26,0	2,73	1,75	0,20	0,20	6	2,20	6	330
	3,15	26,0	3,23	2,20	0,20	0,20	6	3,00	6	332
P										●
M										●
K										●
N										●
S										●
H										●
O										●

→ v_c/f_z Page 80

When calculating the feedrate for circular milling it is important to know whether contour feed v_f or feed on the center path v_{fm} is used. Details on → Page 82+83.

ModuSet – Milling inserts for circlip grooves with chamfer

▲ Both edges chamfered CHWTL x 45°

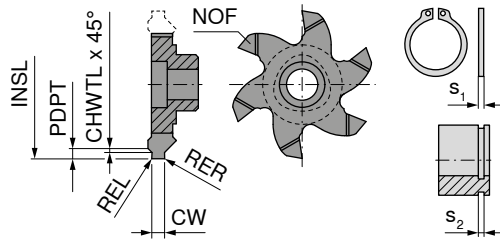

Ti500



Solid carbide

50 879 ...

Size	s ₂ H13 mm	INSL mm	CW _{-0.03} mm	PDPT mm	REL mm	RER mm	CHWTL mm	s ₁ mm	NOF	
7	1,10	16,0	1,18	0,50	0,05	0,05	0,10	1,00	6	292
	1,30	16,0	1,38	0,85	0,05	0,05	0,15	1,20	6	302
	1,60	16,0	1,68	1,00	0,10	0,10	0,15	1,50	6	304
	1,85	16,0	1,93	1,25	0,10	0,10	0,20	1,75	6	306
9	1,10	20,0	1,18	0,50	0,05	0,05	0,10	1,00	6	307
	1,30	20,0	1,38	0,85	0,05	0,05	0,15	1,20	6	308
	1,60	20,0	1,68	1,00	0,10	0,10	0,15	1,50	6	309
	1,60	21,7	1,68	1,00	0,10	0,10	0,15	1,50	6	312
	1,85	20,0	1,93	1,25	0,10	0,10	0,20	1,75	6	310
	1,85	21,7	1,93	1,25	0,10	0,10	0,20	1,75	6	314
	2,15	21,7	2,23	1,50	0,10	0,10	0,20	2,00	6	316
	2,65	21,7	2,73	1,75	0,20	0,20	0,20	2,50	6	318
10	1,30	26,0	1,38	0,85	0,05	0,05	0,15	1,20	6	322
	1,60	26,0	1,68	1,00	0,10	0,10	0,15	1,50	6	324
	1,85	26,0	1,93	1,25	0,10	0,10	0,20	1,75	6	326
	2,15	26,0	2,23	1,50	0,10	0,10	0,20	2,00	6	328
	2,65	26,0	2,73	1,75	0,20	0,20	0,20	2,50	6	330
	3,15	26,0	3,23	1,75	0,20	0,20	0,20	3,00	6	332
P										●
M										●
K										●
N										●
S										●
H										●
O										●

7

→ v_c/f_z Page 80

i When calculating the feedrate for circular milling it is important to know whether contour feed v_f or feed on the center path v_{fm} is used. Details on → Page 82+83.

ModuSet – Milling insert without profile

- ▲ Size 7: from 5.0 mm groove width with ground chip breaker
- ▲ Size 10: from 6.5 mm groove width with ground chip breaker

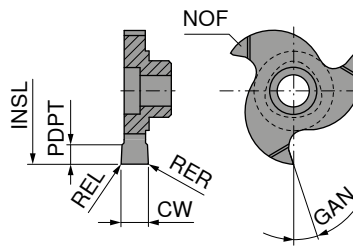

Solid carbide

50 875 ...

Size	CW <small>+/-0.02</small> mm	INSL mm	PDPT mm	REL mm	RER mm	GAN °	NOF	
6	1,5	11,7	2,25	0,10	0,10	6	3	302
	2,0	11,7	2,25	0,15	0,15	6	3	304
	2,5	11,7	2,25	0,15	0,15	6	3	306
	3,0	11,7	2,25	0,15	0,15	6	3	308
7	3,5	16,0	3,50	0,15	0,15	0	3	310
	3,5	16,0	3,50	0,15	0,15	8	3	312
	3,5	16,0	3,50	0,15	0,15	12	3	314
	5,0	16,0	3,50	0,15	0,15	0	3	316
	5,0	16,0	3,50	0,15	0,15	8	3	318
	5,0	16,0	3,50	0,15	0,15	12	3	320
10	4,0	25,0	5,70	0,15	0,15	0	3	330
	4,0	25,0	5,70	0,15	0,15	8	3	332
	4,0	25,0	5,70	0,15	0,15	12	3	334
	5,0	25,0	5,70	0,15	0,15	8	3	337
	6,5	25,0	5,70	0,15	0,15	0	3	340
	6,5	25,0	5,70	0,15	0,15	8	3	342
	6,5	25,0	5,70	0,15	0,15	12	3	344
	8,0	25,0	5,70	0,15	0,15	0	3	350
	8,0	25,0	5,70	0,15	0,15	8	3	352
	8,0	25,0	5,70	0,15	0,15	12	3	354

P	●
M	●
K	●
N	●
S	●
H	●
O	●

→ v_c/f_z Page 80

When calculating the feedrate for circular milling it is important to know whether contour feed v_c or feed on the center path v_{fm} is used. Details on → Page 82+83.

ModuSet – Milling insert without profile

Polygon

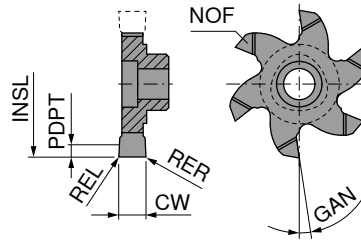

Ti500



Solid carbide

50 876 ...

Size	CW <small>+/-0,02</small> mm	INSL mm	PDPT mm	REL mm	RER mm	GAN °	NOF	
7	1,5	17,7	4,0	0,10	0,10	6	6	307
	2,0	17,7	4,0	0,10	0,10	6	6	308
	2,5	17,7	4,0	0,15	0,15	6	6	309
	3,0	16,0	3,5	0,15	0,15	6	6	302
	4,0	16,0	3,5	0,15	0,15	6	6	304
	5,0	16,0	3,5	0,15	0,15	6	6	306
9	1,5	21,7	5,0	0,10	0,10	6	6	314
	2,0	21,7	5,0	0,10	0,10	6	6	315
	2,5	21,7	5,0	0,15	0,15	6	6	316
	3,0	21,7	5,0	0,15	0,15	6	6	317
	3,0	20,0	4,2	0,15	0,15	6	6	311
	4,0	20,0	4,2	0,15	0,15	6	6	312
	5,0	20,0	4,2	0,15	0,15	6	6	313
10	1,5	27,7	6,8	0,10	0,10	6	6	330
	2,0	27,7	6,8	0,10	0,10	6	6	332
	2,5	27,7	6,8	0,15	0,15	6	6	334
	3,0	26,0	6,2	0,15	0,15	6	6	322
	3,0	27,7	6,8	0,15	0,15	6	6	336
	4,0	26,0	6,2	0,15	0,15	6	6	324
	5,0	26,0	6,2	0,15	0,15	6	6	326
	6,5	26,0	6,2	0,15	0,15	6	6	328
P								●
M								●
K								●
N								●
S								●
H								●
O								●

7

→ v_c/f_z Page 80



When calculating the feedrate for circular milling it is important to know whether contour feed v_c or feed on the center path v_{im} is used. Details on → Page 82+83.

ModuSet – Milling inserts for radius milling

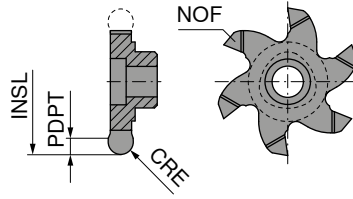

Ti500



Solid carbide

50 886 ...

Size	CRE mm	INSL mm	PDPT mm	NOF	
6	1,100	9,6	1,20	3	702
	0,788	11,7	2,25	3	704
	1,100	11,7	2,25	3	708
	1,190	11,7	2,25	3	706
7	0,788	17,7	4,20	6	712
	1,100	17,7	4,20	6	714
9	0,785	21,7	5,00	6	720
	1,000	21,7	5,00	6	722
	1,200	21,7	5,00	6	724
	1,400	21,7	5,00	6	726
	1,500	21,7	5,00	6	728

P	•
M	•
K	•
N	•
S	•
H	•
O	•

→ v_c/f_z Page 80

ModuSet – Milling inserts for chamfering and deburring

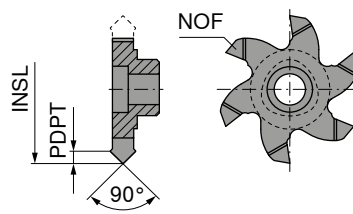

Ti500



Solid carbide

50 884 ...

Size	PDPT mm	INSL mm	NOF	
6	1,20	9,6	3	292
	1,50	11,7	3	294
7	1,90	16,0	6	302
	1,30	17,7	6	304
9	1,90	20,0	6	312
	1,95	21,7	6	314
10	2,10	26,0	6	322

P	•
M	•
K	•
N	•
S	•
H	•
O	•

→ v_c/f_z Page 80

ModuSet – Milling insert for part-off

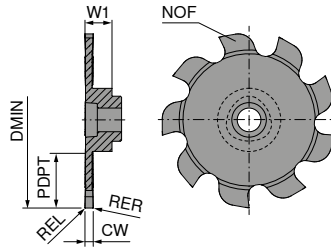

NEW
Ti500



Solid carbide

51 800 ...

Size	DMIN mm	PDPT mm	CW _{-0,02} mm	REL mm	RER mm	W1 mm	NOF	
6	14	3,40	1,5	0,1	0,1	3,50	6	14000
7	22	6,40	1,5	0,1	0,1	3,86	9	22000
9	32	10,25	1,5	0,1	0,1	4,91	9	32000
10	37	11,50	1,5	0,1	0,1	4,86	9	37000
P								•
M								•
K								•
N								•
S								•
H								•
O								•

→ v_c/f_z Page 80

 When calculating the feedrate for circular milling it is important to know whether contour feed v_f or feed on the center path v_{fm} is used. Details on → Page 82+83.

7

ModuSet – Thread milling insert – Partial profile

▲ with holder 50 805 010 / 50 805 011 maximum pitch of 3 mm is possible!

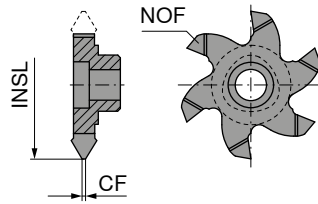
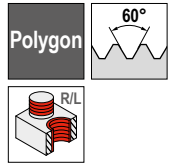

Ti500
Solid carbide
50 882 ...
292
306
302
304
314
312
316
322
324
32600

Size	TP mm	INSL mm	CF mm	NOF
6	1 - 3	11,7	0,10	3
7	1 - 3	17,7	0,10	6
	1 - 4	16,0	0,10	6
	2,5 - 4	16,0	0,25	6
9	1 - 2	21,7	0,10	6
	1 - 3	20,0	0,10	6
	2 - 4	21,7	0,15	6
10	1 - 3	26,0	0,10	6
	2,5 - 5	26,0	0,25	6
	3,5 - 6	26,0	0,40	6

- P ●
- M ●
- K ●
- N ●
- S ●
- H ●
- O ●

→ v_c/f_z Page 80

1 When calculating the feedrate for circular milling it is important to know whether contour feed v_f or feed on the center path v_{fm} is used. Details on → **Page 82+83.**

ModuSet – Thread milling insert – Full profile

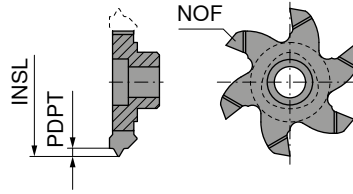
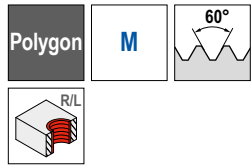

Ti500



Solid carbide

50 881 ...

Size	TP mm	INSL mm	PDPT mm	NOF	
6	1	9,6	0,572	3	292
	1,5	9,6	0,875	3	293
	2	10,5	1,157	3	296
7	1,5	16,0	0,875	6	302
	2	16,0	1,157	6	304
	2,5	16,0	1,430	6	306
	3	16,0	1,702	6	310
	M20x2,5	16,0	1,430	6	308 ¹⁾
9	1,5	20,0	0,875	6	312
	2	20,0	1,157	6	314
	M24x3	20,0	1,702	6	316 ¹⁾
10	1,5	26,0	0,875	6	322
	2	26,0	1,157	6	324
	3	26,0	1,702	6	330
	3,5	26,0	1,982	6	332
	4	26,0	2,263	6	334
	4,5	26,0	2,553	6	336
	5	26,0	2,836	6	337
	M30x3,5	24,0	1,982	6	331 ¹⁾
M36x4	26,0	2,263	6	335 ¹⁾	
P					●
M					●
K					●
N					●
S					●
H					●
O					●

1) profile corrected

→ v_c/f_z Page 80

When calculating the feedrate for circular milling it is important to know whether contour feed v_f or feed on the center path v_{fm} is used. Details on → Page 82+83.

ModuSet – Thread milling insert – Full profile

▲ 50 883 322 for threads > 1"

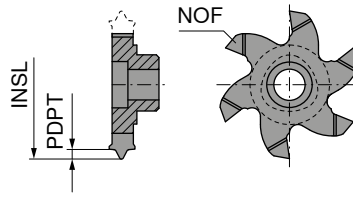

Ti500



Solid carbide

50 883 ...

Size	TPI 1/"	TP mm	INSL mm	PDPT mm	NOF	
6	19	1,337	9,6	0,871	3	292
7	14	1,814	17,7	1,177	6	308
	14	1,814	16,0	1,177	6	304
	11	2,309	16,0	1,494	6	302
	10	2,540	16,0	1,646	6	306
9	14	1,814	20,0	1,177	6	316
	11	2,309	20,0	1,494	6	314
10	11	2,309	26,0	1,494	6	322
P						●
M						●
K						●
N						●
S						●
H						●
O						●

→ v_c/f_z Page 80

i When calculating the feedrate for circular milling it is important to know whether contour feed v_f or feed on the center path v_{fm} is used. Details on → Page 82+83.

ModuSet – Thread milling insert – Full profile

▲ DIN 103

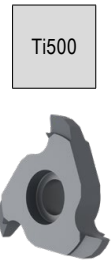
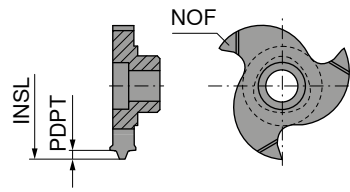
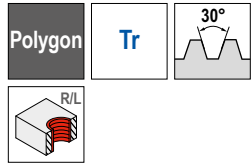

Solid carbide
50 872 ...

Size	TP mm	INSL mm	PDPT mm	NOF	Thread	
6	2	11,7	1,25	3	Tr 16x2 - Tr 20x2	292
	3	11,0	1,75	3	Tr 18x3 - Tr 20x3	294
	4	12,0	2,25	3	Tr 20x4	296 ¹⁾
7	3	14,0	1,75	3	Tr 24x3 - Tr 32x3	302 ²⁾
	5	15,3	2,75	3	Tr 28x5 - Tr 36x5	306 ³⁾
	5	15,3	2,75	3	Tr 26x5	304 ³⁾
	6	16,2	3,50	3	Tr 34x6 - Tr 42x6	310 ²⁾
	6	16,2	3,50	3	Tr 30x6 - Tr 32x6	308 ²⁾
10	5	25,0	2,75	3	Tr 44x5 - Tr 48x5	322 ⁴⁾
	7	22,0	3,75	3	Tr 38x7 - Tr 42x7	324 ⁴⁾

P	●
M	●
K	●
N	●
S	●
H	●
O	●

- 1) profile corrected
- 2) Not suitable for the 50 805 011 and 50 805 010 holders
- 3) Not suitable for the 50 805 011 and 50 805 010 holders / profile corrected
- 4) Not suitable for the 50 805 026, 50 805 025 and 50 805 024 holders

→ v_c/f_z Page 80

When calculating the feedrate for circular milling it is important to know whether contour feed v_t or feed on the center path v_{fm} is used. Details on → Page 82+83.

7

ModuSet – Thread milling insert – Full profile

▲ with holder 50 805 010 / 50 805 011 maximum pitch of 3 mm is possible!

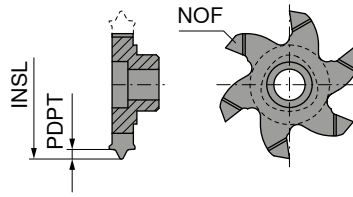
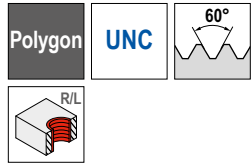

Ti500



Solid carbide

50 886 ...

Size	TPI 1/"	INSL mm	PDPT mm	NOF	
6	12	9,6	1,228	3	202
	11	10,5	1,355	3	204
	10	11,7	1,485	3	206
7	9	16,0	1,577	6	212
9	8	18,0	1,809	6	222
	7	20,0	2,043	6	224

P	•
M	•
K	•
N	•
S	•
H	•
O	•

→ v_c/f_z Page 80

ModuSet – Thread milling insert – Full profile

▲ with holder 50 805 010 / 50 805 011 maximum pitch of 3 mm is possible!

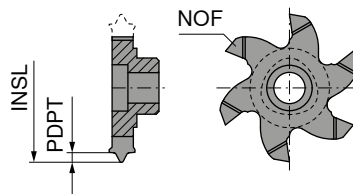
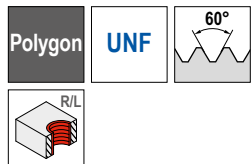

Ti500



Solid carbide

50 886 ...

Size	Thread	INSL mm	PDPT mm	NOF	
6	1/2 - 20	9,6	0,733	3	302
	9/16 - 18	10,5	0,827	3	304
	3/4 - 16	11,7	0,945	3	306
7	7/8 - 14	17,7	1,071	6	312
9	1 - 12	20,0	1,228	6	322

P	•
M	•
K	•
N	•
S	•
H	•
O	•

→ v_c/f_z Page 80

When calculating the feedrate for circular milling it is important to know whether contour feed v_f or feed on the center path v_{fm} is used. Details on → Page 82+83.

ModuSet – Circular milling cutter

- ▲ For maximum machining depth, note insert width (CW)
- ▲ Size 6 = for INSL 9.6; 10.5; 11.7; 12
- ▲ Size 7 = for INSL 16; 17.7
- ▲ Size 9 = for INSL 18; 20; 21.7
- ▲ Size 10 = for INSL 24; 25; 26; 27.7
- ▲ Holder available as screw-in variant in the online shop

Scope of supply:
including key

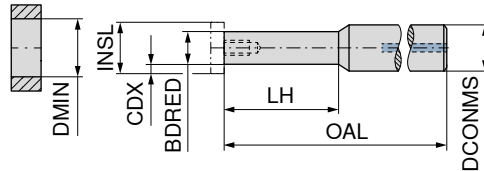

Size	LH mm	CDX mm	DCONMS _{h6} mm	OAL mm	BDRED mm	DMIN mm	torque moment Nm	50 805 ...	
6	20,00	2,25	12	67,5	7,0	12	1,0		050 ¹⁾
	20,00	2,25	12	67,5	7,0	12	1,0		051
	20,00	2,25	12	67,5	7,0	12	1,0	052	
	30,00	2,25	12	80,0	7,0	12	1,0		053
	30,00	2,25	12	80,0	7,0	12	1,0	054	
	40,00	2,25	12	100,0	7,0	12	1,0		055
7	20,90	4,00	12	67,4	9,0	18	1,1		002 ¹⁾
	21,00	4,00	12	67,4	9,0	18	1,1		004
	21,00	4,00	12	67,4	9,0	18	1,1	005	
	36,00	4,00	12	82,4	9,0	18	1,1		008
	36,00	4,00	12	82,4	9,0	18	1,1	085	
		4,00	12	122,5	12,0	18	1,1	010	
9	29,75	5,00	16	80,0	11,5	22	3,8		070 ¹⁾
	30,00	5,00	16	80,0	11,5	22	3,8		071
	30,00	5,00	16	80,0	11,5	22	3,8	072	
	50,00	5,00	16	100,0	11,5	22	3,8		073
	50,00	5,00	16	100,0	11,5	22	3,8	074	
10	20,50	5,70	16	105,0	15,5	28	5,5	025	
	20,50	6,80	16	149,7	15,5	28	5,5	024	
	20,50	6,80	20	175,4	15,5	28	5,5	026	
	30,40	6,80	16	79,6	13,6	28	5,5		012 ¹⁾
	30,50	6,80	16	79,6	13,6	28	5,5	015	
	30,50	6,80	16	79,6	13,6	28	5,5		014
	45,50	6,80	16	94,6	13,6	28	5,5	021	
	45,50	6,80	16	94,6	13,6	28	5,5		020
	60,50	6,80	16	109,6	13,6	28	5,5		022
	60,50	6,80	16	109,6	13,6	28	5,5	023	

1) Steel version

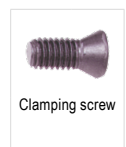
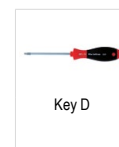

Spare parts
Size

Size		80 950 ...		70 960 ...
6	T08 - IP	125	M2,5x7	246
7	T08 - IP	125	M3x13	231
9	T15 - IP	128	M4x13	236
10	T20 - IP	129	M5x13,5	243

ModuSet – Milling insert for circlip grooves

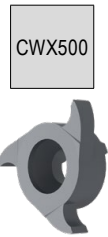
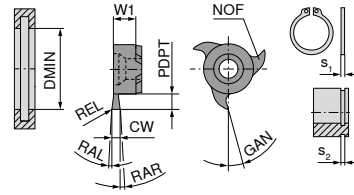
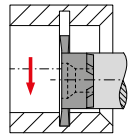

Solid carbide

53 006 ...

Size	DMIN mm	s ₂ H13 mm	CW _{-0.02} mm	PDPT mm	W1 mm	REL mm	RAL °	RAR °	GAN °	s ₁ mm	NOF	
10	10	0,70	0,74	1,5	3,50		1	1	15	0,60	3	070
	10	0,80	0,84	1,5	3,50		1	1	15	0,70	3	080
	10	0,90	0,94	1,5	3,50		1	1	15	0,80	3	090
	10	1,10	1,21	1,5	3,50		3	3	15	1,00	3	110
	10	1,30	1,41	1,5	3,50	0,10	3	3	15	1,20	3	130
	10	1,60	1,71	1,5	3,50	0,10	3	3	15	1,50	3	160
	12	1,10	1,21	2,5	3,50		3	3	15	1,00	3	112
	12	1,30	1,41	2,5	3,50	0,10	3	3	15	1,20	3	132
	12	1,60	1,71	2,5	3,50	0,10	3	3	15	1,50	3	162
18	18	0,70	0,74	1,5	5,75		1	1	15	0,60	3	270
	18	0,80	0,84	1,7	5,75		1	1	15	0,70	3	280
	18	0,90	0,94	1,9	5,75		1	1	15	0,80	3	290
	18	1,10	1,21	3,5	5,75		3	3	15	1,00	3	310
	18	1,30	1,41	3,5	5,75	0,10	3	3	15	1,20	3	330
	18	1,60	1,71	3,5	5,75	0,10	3	3	15	1,50	3	360
22	22	0,70	0,74	1,5	5,70		1	1	15	0,60	3	470
	22	0,80	0,84	1,7	5,70		1	1	15	0,70	3	480
	22	0,90	0,94	1,9	5,70		1	1	15	0,80	3	490
	22	1,00	1,04	2,1	5,70		1	1	15	0,90	3	500
	22	1,10	1,21	2,5	5,70		1	1	15	1,00	3	510
	22	1,30	1,41	4,5	5,70	0,10	3	3	15	1,20	3	530
	22	1,60	1,71	4,5	5,70	0,10	3	3	15	1,50	3	560
	22	1,85	1,96	4,5	5,70	0,15	3	3	15	1,75	3	585
	22	2,15	2,26	4,5	5,70	0,15	3	3	15	2,00	3	615
	22	2,65	2,76	4,5	5,70	0,15	3	3	15	2,50	3	665
	22	3,15	3,26	4,5	5,70	0,20	3	3	15	3,00	3	415
	22	4,15	4,26	4,5	5,70	0,20	3	3	15	4,00	3	515
	22	5,15	5,26	4,5	5,70	0,20	3	3	15	5,00	3	605

P	●
M	●
K	●
N	●
S	○
H	
O	●

→ v_c/f_z Page 81

When calculating the feedrate for circular milling it is important to know whether contour feed v_f or feed on the center path v_{fm} is used. Details on → Page 82+83.

ModuSet – Milling insert for groove milling

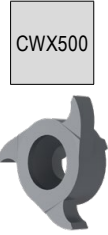
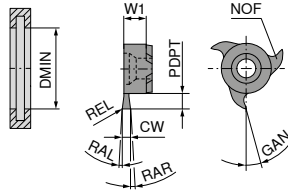
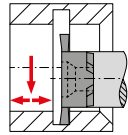
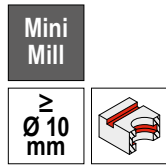

Solid carbide

53 007 ...

Size	DMIN mm	CW _{0.02} mm	PDPT mm	W1 mm	REL mm	RAL °	RAR °	GAN °	NOF	
10	10	1,0	1,5	3,50	0,1	3	3	15	3	010
	10	1,5	1,5	3,50	0,2	3	3	15	3	015
	10	2,0	1,5	3,50	0,2	3	3	15	3	020
	10	2,5	1,5	3,50	0,2	3	3	15	3	025
	12	1,5	2,0	3,50	0,2	3	3	15	6	114
	12	1,5	2,5	3,50	0,2	3	3	15	3	115
	12	2,0	2,0	3,50	0,2	3	3	15	6	119
	12	2,0	2,5	3,50	0,2	3	3	15	3	120
	12	2,5	2,5	3,50	0,2	3	3	15	3	125
	14	14	1,0	2,5	4,50		3	3	15	3
14		1,5	2,5	4,50	0,2	3	3	15	3	215
14		2,0	2,5	4,50	0,2	3	3	15	3	220
14		2,5	2,5	4,50	0,2	3	3	15	3	225
16		1,5	3,5	4,50	0,2	3	3	15	3	315
16		2,0	3,5	4,50	0,2	3	3	15	3	320
16		2,5	3,5	4,50	0,2	3	3	15	3	325
18	18	1,5	3,5	5,75	0,1	3	3	15	6	414
	18	1,5	3,5	5,75	0,2	3	3	15	3	415
	18	2,0	3,5	5,75	0,2	3	3	15	3	420
	18	2,0	3,5	5,75	0,2	3	3	15	6	419
	18	2,5	3,5	5,75	0,2	3	3	15	6	424
	18	2,5	3,5	5,75	0,2	3	3	15	3	425
	18	3,0	3,5	5,75	0,2	3	3	15	6	429
	18	3,0	3,5	5,75	0,2	3	3	15	3	430
	18	4,0	3,5	5,75	0,2	3	3	15	3	440
	22	22	1,0	4,5	6,20	0,1	3	3	15	6
22		1,5	4,5	5,70	0,2	3	3	15	3	815
22		1,5	4,5	6,20	0,1	3	3	15	6	820
22		2,0	4,5	6,20	0,2	3	3	15	6	825
22		2,0	4,5	5,70	0,2	3	3	15	3	520
22		2,5	4,5	6,20	0,2	3	3	15	6	825
22		2,5	4,5	5,70	0,2	3	3	15	3	525
22		3,0	4,5	5,70	0,2	3	3	15	3	530
22		3,0	4,5	6,20	0,2	3	3	15	6	830
22		3,5	4,5	5,70	0,2	3	3	15	3	535
22		4,0	4,5	5,70	0,2	3	3	15	3	540
22		4,0	4,5	6,20	0,2	3	3	15	6	840
28		25	2,0	5,0	6,50	0,2	3	3	15	3
	25	2,5	5,0	6,50	0,2	3	3	15	3	625
	25	3,0	5,0	6,50	0,2	3	3	15	3	630
	25	3,5	5,0	6,50	0,2	3	3	15	3	635
	25	4,0	5,0	6,50	0,2	3	3	15	3	640
	28	1,0	6,5	6,25	0,1	3	3	15	6	610
	28	1,5	6,5	6,25	0,1	3	3	15	6	615
	28	1,5	6,5	6,50	0,2	3	3	15	3	715
	28	2,0	6,5	6,25	0,2	3	3	15	6	721
	28	2,0	6,5	6,50	0,2	3	3	15	3	720
	28	2,5	6,5	6,25	0,2	3	3	15	6	726
	28	2,5	6,5	6,50	0,2	3	3	15	3	725
	28	3,0	6,5	6,50	0,2	3	3	15	3	730
	28	3,0	6,5	6,25	0,2	3	3	15	6	731
	28	3,5	6,5	6,50	0,2	3	3	15	3	735
	28	4,0	6,5	6,25	0,2	3	3	15	6	741
	28	4,0	6,5	6,50	0,2	3	3	15	3	740
	28	5,0	6,5	6,50	0,2	3	3	15	3	750
	28	6,0	6,5	6,50	0,2	3	3	15	3	760

P	●
M	●
K	●
N	●
S	○
H	
O	●

→ v_c/f_z Page 81

When calculating the feedrate for circular milling it is important to know whether contour feed v_t or feed on the center path v_{im} is used. Details on → Page 82+83.

ModuSet – Milling insert for groove milling (Specialist for aluminium)

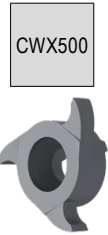
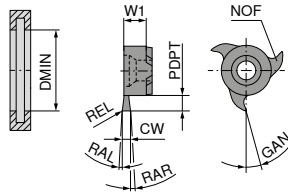
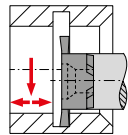
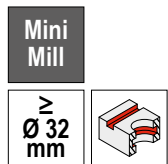

Solid carbide

53 007 ...

Size	DMIN mm	CW _{0.02} mm	PDPT mm	W1 mm	REL mm	RAL °	RAR °	GAN °	NOF	
28	32	2,0	8,5	6,5	0,2	3	3	20	3	920
	32	2,5	8,5	6,5	0,2	3	3	20	3	925
	32	3,0	8,5	6,5	0,2	3	3	20	3	930

P	
M	
K	
N	●
S	
H	
O	

→ v_c/f_z Page 81

ModuSet – Milling insert for groove milling with full radius

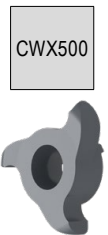
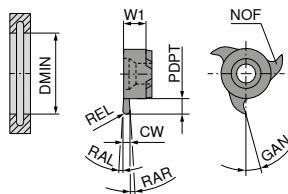
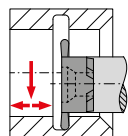
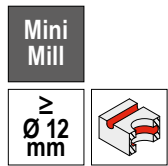

Solid carbide

53 008 ...

Size	DMIN mm	CW _{+0.03} mm	PDPT mm	W1 mm	REL mm	RAL °	RAR °	GAN °	NOF	
10	12	2,2	2,5	3,50	1,1	3	3	15	3	011
14	16	2,2	3,5	4,60	1,1	3	3	15	3	111
18	18	2,2	3,5	5,75	1,1	3	3	15	3	211
22	22	1,0	4,5	5,75	0,5	3	3	15	3	305
	22	1,6	4,5	5,75	0,8	3	3	15	3	308
	22	2,0	4,5	5,75	1,0	3	3	15	3	310
	22	2,4	4,5	5,75	1,2	3	3	15	3	312
	22	2,8	4,5	5,75	1,4	3	3	15	3	314
	22	3,0	4,5	5,75	1,5	3	3	15	3	315
	22	4,0	4,5	5,75	2,0	3	3	15	3	320
	22	4,4	4,5	5,75	2,2	3	3	15	3	322
	22	5,0	4,5	5,75	2,5	3	3	15	3	325

P	●
M	●
K	●
N	●
S	○
H	
O	●

→ v_c/f_z Page 81

When calculating the feedrate for circular milling it is important to know whether contour feed v_f or feed on the center path v_{fm} is used. Details on → Page 82+83.

ModuSet – Milling insert for groove milling, cross-pitched

Mini Mill

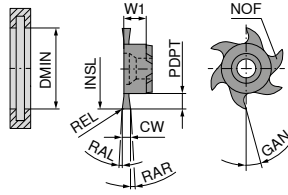
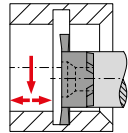
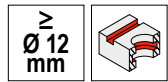

CWX500



Solid carbide

53 015 ...

Size	DMIN mm	INSL mm	CW _{+0,02} mm	PDPT mm	W1 mm	REL mm	RAL °	RAR °	GAN °	NOF	
10	12	11,7	1,5	2,0	3,5	0,2	3	3	15	6	114
	12	11,7	2,0	2,0	3,5	0,2	3	3	15	6	119
14	16	15,7	1,5	2,5	4,5	0,2	3	3	15	6	314
	16	15,7	2,0	2,5	4,5	0,2	3	3	15	6	319
	16	15,7	2,5	2,5	4,5	0,2	3	3	15	6	324
18	18	17,7	2,0	4,0	5,8	0,2	3	3	15	6	419
	18	17,7	2,5	4,0	5,8	0,2	3	3	15	6	424
	18	17,7	3,0	4,0	5,8	0,2	3	3	15	6	429
	20	19,7	2,0	5,0	5,8	0,2	3	3	15	6	469
	20	19,7	2,5	5,0	5,8	0,2	3	3	15	6	474
	20	19,7	3,0	5,0	5,8	0,2	3	3	15	6	479
22	22	21,7	2,0	4,5	6,2	0,2	3	3	15	6	820
	22	21,7	2,5	4,5	6,2	0,2	3	3	15	6	825
	22	21,7	3,0	4,5	6,2	0,2	3	3	15	6	830
	22	21,7	4,0	4,5	6,2	0,2	3	3	15	6	840
	37	36,7	1,5	12,0	6,2	0,1	3	3	15	6	865
	37	36,7	2,0	12,0	6,2	0,2	3	3	15	6	870
28	25	24,8	2,5	5,0	6,4	0,2	3	3	15	6	626
	25	24,8	3,0	5,0	6,4	0,2	3	3	15	6	631
	25	24,8	4,0	5,0	6,4	0,2	3	3	15	6	641
	25	24,8	5,0	5,0	6,4	0,2	3	3	15	6	651
	25	24,8	6,0	5,0	6,4	0,2	3	3	15	6	661
	28	27,7	2,5	6,5	6,2	0,2	3	3	15	6	726
	28	27,7	3,0	6,5	6,2	0,2	3	3	15	6	731
	28	27,7	4,0	6,5	6,2	0,2	3	3	15	6	741
	28	27,7	5,0	6,5	6,2	0,2	3	3	15	6	751
	28	27,7	6,0	6,5	6,2	0,2	3	3	15	6	761
	35	34,7	2,0	10,0	6,2	0,2	3	3	15	6	770
	35	34,7	2,5	10,0	6,2	0,2	3	3	15	6	775
	35	34,7	3,0	10,0	6,2	0,2	3	3	15	6	780

P	●
M	●
K	●
N	●
S	○
H	
O	●

→ v_c/f_z Page 81

When calculating the feedrate for circular milling it is important to know whether contour feed v_f or feed on the center path v_{fm} is used. Details on → Page 82+83.

ModuSet – Milling insert for groove milling and chamfering

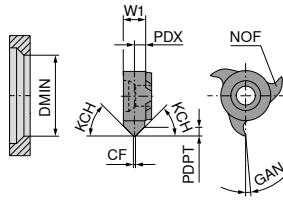
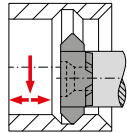
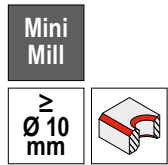

CWX500



Solid carbide

53 009 ...

Size	DMIN mm	CF ^{+0,03} mm	PDPT mm	W1 mm	KCH °	PDX mm	GAN °	NOF	
10	10	0,2	0,35	3,60	15	1,80	5	6	015
	10	0,2	0,45	3,60	20	1,80	5	6	020
	10	0,2	0,70	3,60	30	1,80	5	6	030
	10	0,2	1,20	3,60	45	1,80	5	6	045
	12	1,2	0,80	3,50	45	1,20	5	3	035
14	16	1,4	1,20	4,50	45	1,60	5	3	145
18	18	2,5	1,40	5,85	45	1,70	5	3	258
	18	0,2	2,20	5,75	45	3,00	5	6	259
22	22	2,0	1,70	5,85	45	2,00	5	3	358
	22	0,2	2,50	6,40	45	3,90	5	6	463
	22	3,0	3,00	9,40	45	3,25	5	3	394 ¹⁾
28	28	0,2	1,90	6,05	45	3,75	5	6	560
P									●
M									●
K									●
N									●
S									○
H									
O									●

1) Use clamping screw 73 082 006

When calculating the feedrate for circular milling it is important to know whether contour feed v_f or feed on the center path v_{fm} is used. Details on → Page 82+83.

ModuSet – Milling insert for part-off

▲ PDPT = 12,0 mm in combination with holder 53 003 624

▲ reduce feed rate by 50 %

Mini
Mill

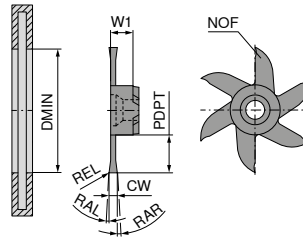
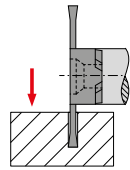
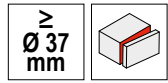

CWX500



Solid carbide

53 013 ...

Size	DMIN mm	CW _{-0,02} mm	PDPT mm	W1 mm	REL mm	RAL °	RAR °	NOF	
22	37	0,5	12	5,6		3	3	6	705 ¹⁾
	37	0,6	12	5,7		3	3	6	706 ¹⁾
	37	0,8	12	6,0		3	3	6	708 ¹⁾
	37	1,0	12	6,2	0,1	3	3	6	710
	37	1,5	12	6,2	0,1	3	3	6	715
P									●
M									●
K									●
N									●
S									○
H									
O									●

1) The end face is not ground free to the center

→ v_c/f_z Page 81

ModuSet – Set for cut off

▲ Size 22

Mini
Mill



53 014 ...

Tool	Designation	Article no.	Bore-Ø mm	Piece	
Inserts	Milling inserts for separating	53 013 715	37	2	990
Tool holder	Endmill short	53 003 624		1	
Screw	M5 x 12	73 082 005		1	
Tightening Key	T20			1	

 When calculating the feedrate for circular milling it is important to know whether contour feed v_f or feed on the center path v_{fm} is used. Details on → Page 82+83.

ModuSet – Milling insert for slot and multipurpose milling

- ▲ Interface with four driving slots
- ▲ CW 1,5 – 6 mm: cross-pitched

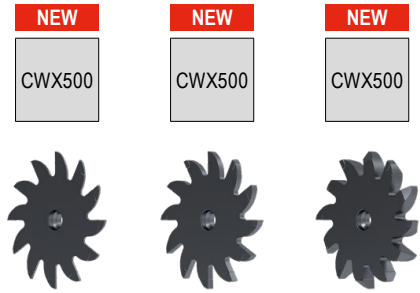
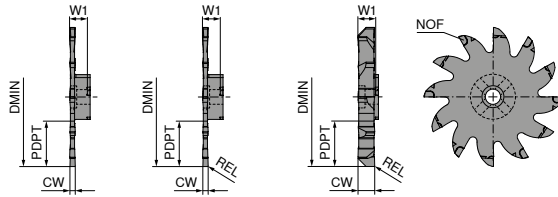
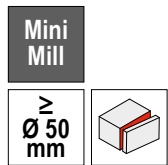

Solid carbide Solid carbide Solid carbide

53 017 ...	53 017 ...	53 017 ...
00500		
01000		
	01500	
	02000	
	02500	
	03000	
		04000
		05000
		06000

Size	DMIN mm	CW $\pm 0,02$ mm	PDPT mm	W1 mm	REL mm	NOF
50	50	0,5	16,5	6,35		12
	50	1,0	16,5	6,35		12
	50	1,5	16,5	6,35	0,1	12
	50	2,0	16,5	6,35	0,2	12
	50	2,5	16,5	6,35	0,2	12
	50	3,0	16,5	6,35	0,2	12
	50	4,0	16,5	6,35	0,2	12
	50	5,0	16,5	6,35	0,2	12
	50	6,0	16,5	6,35	0,2	12

P	●	●	●
M	●	●	●
K	●	●	●
N	●	●	●
S	○	○	○
H			
O	●	●	●

→ v_c/f_z Page 81

1 Suitable holders can be found on → **page 33.**

1 When calculating the feedrate for circular milling it is important to know whether contour feed v_f or feed on the center path v_{fm} is used. Details on → **Page 82+83.**

ModuSet – Milling insert for internal thread milling – Partial profile

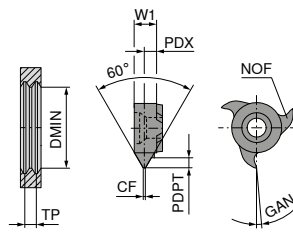
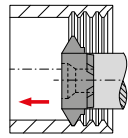
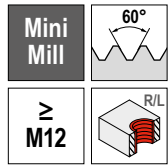

CWX500



Solid carbide

53 010 ...

Size	Thread _{min}	TP mm	DMIN mm	CF mm	PDPT mm	W1 mm	PDX mm	GAN °	NOF	
10	M12	1,0 - 1,75	9,8	0,13	1,02	3,20	2,4	5	6	017
	M14	1,0 - 1,75	11,7	0,13	1,08	3,60	2,8	5	3	010
	M14	1,0 - 2,0	10,1	0,13	1,25	3,20	2,2	5	6	021
	M14	1,0 - 2,0	11,7	0,13	1,25	3,60	2,8	5	3	020
	M16	1,5 - 2,75	11,0	0,19	1,67	3,20	2,0	5	6	027
	M16	1,5 - 2,75	11,7	0,19	1,67	3,60	2,4	5	3	015
	M16	2,0 - 3,0	11,1	0,25	1,78	3,20	1,9	5	6	029
M16	2,0 - 3,0	11,7	0,25	1,78	3,60	2,2	5	3	030	
14	M18	1,0 - 1,75	15,7	0,12	1,08	4,60	3,8	5	3	210
	M18	1,0 - 2,0	15,7	0,12	1,25	4,60	3,5	5	3	220
	M20	1,5 - 2,75	15,7	0,18	1,67	4,60	3,5	5	3	215
	M22	2,5 - 3,0	15,7	0,31	1,78	4,60	3,4	5	3	230
18	M22	1,0 - 1,75	17,7	0,12	1,03	5,85	5,0	5	3	410
	M22	1,0 - 2,0	17,7	0,12	1,19	5,85	4,7	5	3	412
	M22	1,0 - 2,0	17,7	0,12	1,19	5,85	5,0	5	6	416
	M22	1,5 - 2,75	17,7	0,19	1,62	5,85	4,6	5	3	415
	M24	2,0 - 3,0	17,7	0,25	1,73	5,85	4,4	5	3	425
	M24	2,0 - 3,5	17,7	0,25	2,06	5,85	4,2	5	3	455
	M24	2,0 - 3,5	17,7	0,25	2,06	5,85	4,3	5	6	434
	M24	2,0 - 3,75	17,7	0,25	2,22	5,85	4,2	5	3	420
	M24	2,5 - 5,0	17,7	0,31	2,98	5,85	3,8	5	3	430
M24	3,0 - 5,5	17,7	0,38	3,25	5,85	4,2	5	3	435	
22	M27	1,0 - 2,0	21,7	0,12	1,19	5,85	4,6	5	3	610
	M27	1,0 - 2,0	21,7	0,12	1,19	6,20	5,0	5	6	710
	M27	1,5 - 2,75	21,7	0,18	1,62	5,85	4,5	5	3	615
	M27	2,0 - 3,75	21,7	0,25	2,22	5,85	4,2	5	3	620
	M27	2,5 - 4,5	21,7	0,25	2,70	5,85	3,7	5	3	655
	M27	2,0 - 4,5	21,7	0,25	2,70	6,05	4,2	5	6	755
	M30	2,5 - 5,0	21,7	0,31	2,98	5,85	3,8	5	3	630
	M30	3,5 - 6,0	21,7	0,44	3,52	5,85	3,4	5	3	640
M30	3,5 - 6,5	21,7	0,44	3,84	5,85	3,2	5	3	645	
28	M33	1,0 - 2,0	27,7	0,12	1,20	6,60	4,5	5	3	820
	M33	1,5 - 2,5	27,7	0,18	1,49	6,60	4,3	5	3	825
	M33	1,5 - 2,5	27,7	0,19	1,60	6,10	5,0	5	6	826
	M36	2,5 - 5,0	27,7	0,38	2,93	6,10	2,3	5	6	850
	M36	2,5 - 5,0	27,7	0,37	2,93	6,60	4,0	5	3	840
M39	4,0 - 6,0	27,7	0,62	3,37	6,60	3,6	5	3	860	

- P ●
- M ●
- K ●
- N ●
- S ○
- H ○
- O ●

→ v_c/f_z Page 81

1 When calculating the feedrate for circular milling it is important to know whether contour feed v_f or feed on the center path v_{fm} is used. Details on → Page 82+83.

ModuSet – Milling insert for internal thread milling – Full profile

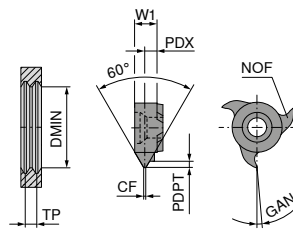
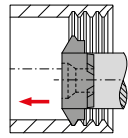

CWX500



Solid carbide

53 011 ...

Size	Thread _{min}	TP	DMIN	CF	PDPT	W1	PDX	GAN	NOF	
		mm	mm	mm	mm	mm	mm	°		
18	M22	1,50	17,7	0,18	0,81	5,85	4,8	5	3	415
	M22	1,75	17,7	0,20	0,95	5,85	4,7	5	3	417
	M22	2,00	17,7	0,25	1,08	5,85	4,6	5	3	420
	M24	2,50	17,7	0,31	1,35	5,85	4,4	5	3	425
	M27	3,00	17,7	0,37	1,62	5,85	4,3	5	3	430
	M27	3,50	17,7	0,43	1,89	5,85	4,0	5	3	435
22	M24	1,50	21,7	0,19	0,81	5,85	4,8	5	3	615
	M24	1,50	21,7	0,19	0,81	6,20	5,3	5	6	715
	M27	1,75	21,7	0,22	0,95	6,20	5,2	5	6	717
	M27	1,75	21,7	0,22	0,95	5,85	4,7	5	3	617
	M27	2,00	21,7	0,25	1,08	6,20	5,0	5	6	720
	M27	2,00	21,7	0,25	1,08	5,85	4,6	5	3	620
	M30	3,00	21,7	0,37	1,62	5,85	4,3	5	3	630
	M30	3,00	21,7	0,37	1,62	6,20	4,8	5	6	730
	M30	3,50	21,7	0,43	1,89	5,85	4,0	5	3	635
	M33	4,00	21,7	0,50	2,16	5,85	3,9	5	3	640
	M33	4,00	21,7	0,50	2,16	6,20	4,4	5	6	740
	M33	4,50	21,7	0,56	2,43	5,85	3,7	5	3	645

- P ●
- M ●
- K ●
- N ●
- S ○
- H ○
- O ●

→ v_c/f_z Page 81

ModuSet – Milling insert for internal thread milling – Full profile

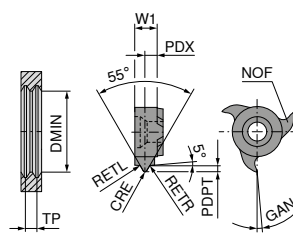
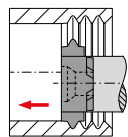

CWX500



Solid carbide

53 012 ...

Size	Thread _{min}	TP	DMIN	TPI	W1	PDX	PDPT	CRE	RETL	RETR	GAN	NOF	
		mm	mm	1/"	mm	mm	mm	mm	mm	mm	°		
10	G 3/8"	1,34	11,7	19	3,60	2,5	0,860	0,18	0,18	0,18	5	3	113
	G 1/2"	1,81	11,7	14	3,60	2,3	1,160	0,24	0,24	0,24	5	3	118
	G 1"	2,31	11,7	11	3,60	2,0	1,480	0,31	0,31	0,31	5	3	123
18		1,34	17,7	19	5,85	4,9	0,856	0,18	0,18	0,18	5	3	219
	G 3/4"	1,81	17,7	14	5,85	4,6	1,160	0,24	0,24	0,24	5	3	214
	G 1"	2,31	17,7	11	5,85	4,4	1,480	0,31	0,31	0,31	5	3	211
22	G 1"	2,31	21,7	11	5,85	4,0	1,480	0,31	0,31	0,31	5	3	311
		3,17	21,7	8	5,85	3,5	2,030	0,43	0,43	0,43	5	3	308
	BSW 1 1/2"	4,23	21,7	6	5,85	3,1	2,710	0,58	0,58	0,58	5	3	306

- P ●
- M ●
- K ●
- N ●
- S ○
- H ○
- O ●

→ v_c/f_z Page 81

ModuSet – Circular milling cutter, extra short

▲ Steel Version

Scope of supply:
including key

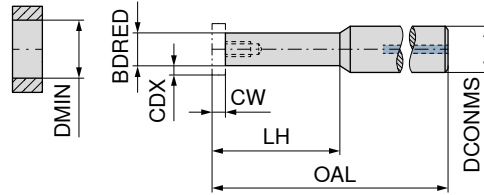

Steel
53 004 ...

Size	DCONMS _{h6} mm	BDRED mm	OAL mm	LH mm	DMIN mm	CW mm	CDX mm	torque moment Nm	
10	10	6,0	60	15,2	9,7 / 11,7	≤3,35	1,4 / 2,5	2,0	015
14	10	8,0	60	17,7	13,7 / 15,7	≤4,35	2,5 / 3,5	3,5	217
	13	8,0	70	25,7	13,7 / 15,7	≤4,35	2,5 / 3,5	3,5	225
18	10	9,0	60	17,0	17,7	≤5,6	3,5	4,5	417
	13	9,0	70	25,0	17,7	≤5,6	3,5	4,5	425
22	10	11,3	60	10,7	21,7	≤9,15	4,5	7,0	610
	13	11,3	70	25,7	21,7	≤9,15	4	7,0	625
28	13	14,0	70	10,7	27,7	≤10	6,5	7,0	810
	20	14,0	100	35,7	27,7	≤10	6,5	7,0	835

7

ModuSet – Circular milling cutter, short

▲ Steel Version

Scope of supply:
including key

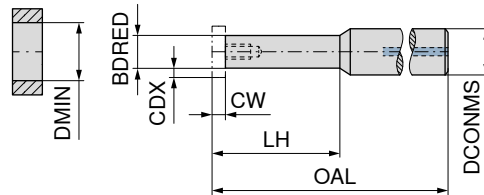

Steel
53 002 ...



Steel
53 003 ...

Size	DCONMS _{h6} mm	BDRED mm	OAL mm	LH mm	DMIN mm	CW mm	CDX mm	torque moment Nm		
10	16	6	80	12,0	9,7 / 11,7	≤3,35	1,4 / 2,5	2,0	012	012
14	16	8	80	16,0	13,7 / 15,7	≤4,35	2,5 / 3,5	3,5	216	216
18	16	9	80	18,0	17,7	≤5,6	3,5	4,5	418	418
22	16	12	80	24,0	21,7	≤9,15	4,5	7,0	624	624
28	20	14	100	35,7	27,7	≤10	6,5	7,0		835

When calculating the feedrate for circular milling it is important to know whether contour feed v_f or feed on the center path v_{fm} is used. Details on → Page 82+83.

ModuSet – Circular milling cutter, vibration-damped

Scope of supply:
including key

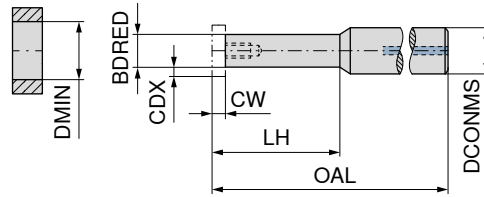

Size	DCONMS _{h6} mm	BDRED mm	OAL mm	LH mm	DMIN mm	CW mm	CDX mm	torque moment Nm	53 001 ...		53 000 ...	
10	12	6,0	80	21	9,7 / 11,7	≤3,35	1,4 / 2,5	2,0	021	021		
	12	6,0	90	30	9,7 / 11,7	≤3,35	1,4 / 2,5	2,0	030	030		
	12	6,0	100	42	9,7 / 11,7	≤3,35	1,4 / 2,5	2,0	042	042		
	12	7,3	90	30	9,7 / 11,7	≤3,35	0,9 / 1,85	2,0	130	130		
	16	7,3	100	25	9,7 / 11,7	≤3,35	0,9 / 1,85	2,0	025	025		
14	12	8,0	95	29	13,7 / 15,7	≤4,35	2,5 / 3,5	3,5	229	229		
	12	8,0	110	42	13,7 / 15,7	≤4,35	2,5 / 3,5	3,5	242	242		
	12	8,0	120	56	13,7 / 15,7	≤4,35	2,5 / 3,5	3,5	256	256		
	12	9,5	110	42	13,7 / 15,7	≤4,35	1,65 / 2,7	3,5	342	342		
	16	9,5	110	33	13,7 / 15,7	≤4,35	1,65 / 2,7	3,5	233	233		
18	12	9,0	100	32	17,7	≤5,6	3,5	4,5	432	432		
	12	9,0	100	45	17,7	≤5,6	3,5	4,5	445	445		
	12	9,0	120	64	17,7	≤5,6	3,5	4,5	464	464		
	16	9,0	93	25	17,7	≤5,6	3,5	4,5	425	425		
	16	9,0	100	32	17,7	≤5,6	3,5	4,5	532	532		
	16	9,0	110	45	17,7	≤5,6	3,5	4,5	545	545		
	16	9,0	130	64	17,7	≤5,6	3,5	4,5	564	564		
	16	13,0	110	64	17,7	≤5,6	1,5	4,5	465	465		
	16	13,0	130	66	17,7	≤5,6	1,5	4,5	466	466		
22	12		100	42	21,7	≤9,15	4,5	7,0	642	642		
	12		130	60	21,7	≤9,15	4,5	7,0	660	660		
	16	11,5	90	30	21,7	≤9,15	4,5	7,0	630	630		
	16	12,0	100	42	21,7	≤9,15	4,5	7,0	742	742		
	16	12,0	130	60	21,7	≤9,15	4,5	7,0	760	760		
	16	12,0	160	85	21,7	≤9,15	4,5	7,0	685	685		
	20	16,0	110	45	21,7	≤9,15	2,5	7,0	645	645		
	20	16,0	130	65	21,7	≤9,15	2,5	7,0	665	665		
28	16	14,3	100	42	27,7 / 24,8	≤10	6,5 / 5	7,0	842	842		
	16	14,3	130	60	27,7 / 24,8	≤10	6,5 / 5	7,0	860	860		
	16	14,3	160	85	27,7 / 24,8	≤10	6,5 / 5	7,0	885	885		
	20	13,5	104	35	27,7 / 24,8	≤10	6,5 / 5	7,0	835	835		
	20	14,3	160	85	27,7 / 24,8	≤10	6,5 / 5	7,0	985	985		

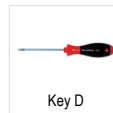

Key D



Clamping screw

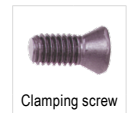

Clamping screw

Spare parts

Size		80 950 ...	73 082 ...	73 082 ...		
10	T08	110		M2,6	002	
14	T10	112		M3,5	003	
18	T15	113		M4	004	
22	T20	114	M5	006	M5	005
28	T20	114		M5	005	

1 Clamping screw 73 082 006 only for insert 53 009 394

1 When calculating the feedrate for circular milling it is important to know whether contour feed v_f or feed on the center path v_{fm} is used. Details on → Page 82+83.

ModuSet – Circular milling cutter

- ▲ Steel and carbide versions
- ▲ Specialised cutting point with four driving slots exclusively for cutting operations in the larger diameter range

Scope of supply:
including key

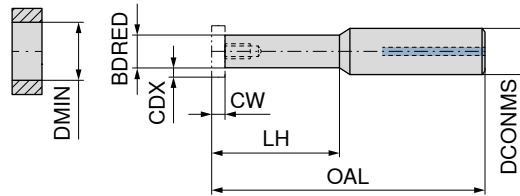

Size	DCONMS _{h6} mm	BDRED mm	OAL mm	LH mm	DMIN mm	CW mm	CDX mm	torque moment Nm		
50	16		125	60	50	≤6	16,5	7,0	53 016 ...	06000
	16		155	90	50	≤6	16,5	7,0	53 016 ...	09000
	16		185	120	50	≤6	16,5	7,0		12000
	20	16	100	32	50	≤6	16,5	7,0		23200

7

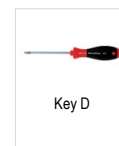

Key D

80 950 ...

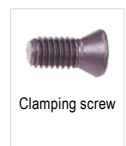

Clamping screw

73 082 ...

Spare parts

Size				
50	T20	114	M5	006

When calculating the feedrate for circular milling it is important to know whether contour feed v_f or feed on the center path v_{fm} is used. Details on → Page 82+83.

ModuSet – Milling inserts for circlip grooves without chamfer

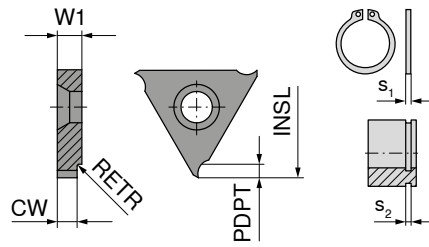

Solid carbide

50 853 ...

Size	s ₂ H13 mm	INSL mm	W1 mm	CW _{-0.03} mm	PDPT mm	RETR mm	s ₁ mm	
03	0,90	10,6	2,34	0,98	0,70	0,3	0,80	302
	1,10	10,6	2,34	1,18	0,90	0,3	1,00	304
	1,30	10,6	2,34	1,38	1,10	0,3	1,20	306
	1,60	10,6	2,34	1,68	1,25	0,3	1,50	308
	1,85	10,6	2,34	1,93	1,25	0,3	1,75	310
02	0,90	17,5	3,50	0,98	0,70	0,3	0,80	312
	1,10	17,5	3,50	1,18	0,90	0,3	1,00	314
	1,30	17,5	3,50	1,38	1,10	0,3	1,20	316
	1,60	17,5	3,50	1,68	1,25	0,3	1,50	318
	1,85	17,5	3,50	1,93	1,25	0,3	1,75	320
	2,15	17,5	3,50	2,23	1,75	0,3	2,00	322
	2,65	17,5	3,50	2,73	1,75	0,3	2,50	324
	3,15	17,5	3,50	3,23	2,20	0,3	3,00	326
01	0,90	23,0	4,00	0,98	0,70	0,3	0,80	328
	1,10	23,0	4,00	1,18	0,90	0,3	1,00	330
	1,30	23,0	4,00	1,38	1,10	0,3	1,20	332
	1,60	23,0	4,00	1,68	1,25	0,3	1,50	334
	1,85	23,0	4,00	1,93	1,25	0,3	1,75	336
	2,15	23,0	4,00	2,23	1,75	0,3	2,00	338
	2,65	23,0	4,00	2,73	1,75	0,3	2,50	340
	3,15	23,0	4,00	3,23	2,20	0,3	3,00	342
P								●
M								●
K								●
N								●
S								●
H								○
O								●

→ v_c/f_z Page 80

When calculating the feedrate for circular milling it is important to know whether contour feed v_c or feed on the center path v_{im} is used. Details on → Page 82+83.

ModuSet – Milling inserts for circlip grooves with chamfer

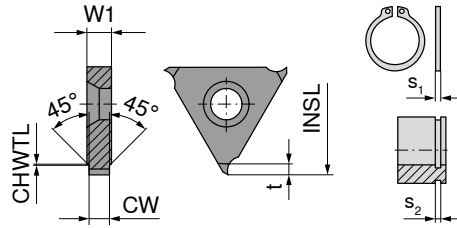

Solid carbide

50 852 ...

Size	s ₂ H13 mm	INSL mm	W1 mm	CW _{-0,03} mm	t mm	CHWTL mm	s ₁ mm	
03	1,10	10,6	2,34	1,18	0,50	0,10	1,00	302
02	1,10	17,5	3,50	1,18	0,50	0,10	1,00	312
	1,30	17,5	3,50	1,38	0,85	0,15	1,20	314
	1,60	17,5	3,50	1,68	1,00	0,15	1,50	316
	1,85	17,5	3,50	1,93	1,25	0,20	1,75	317
	2,15	17,5	3,50	2,23	1,50	0,20	2,00	318
	2,65	17,5	3,50	2,73	1,50	0,20	2,50	319
01	1,10	23,0	4,00	1,18	0,50	0,10	1,00	320
	1,30	23,0	4,00	1,38	0,70	0,15	1,20	321
	1,30	23,0	4,00	1,38	0,85	0,15	1,20	322
	1,60	23,0	4,00	1,68	1,00	0,15	1,50	324
	1,60	23,0	4,00	1,68	0,85	0,15	1,50	323
	1,85	23,0	4,00	1,93	1,25	0,20	1,75	325
	2,15	23,0	4,00	2,23	1,50	0,20	2,00	326
	2,65	23,0	4,00	2,73	1,75	0,20	2,50	328
	2,65	23,0	4,00	2,73	1,50	0,20	2,50	327
	3,15	23,0	4,00	3,32	1,75	0,20	3,00	329

- P ●
- M ●
- K ●
- N ●
- S ●
- H ○
- O ●

→ v_c/f_z Page 80

When calculating the feedrate for circular milling it is important to know whether contour feed v_t or feed on the center path v_{fm} is used. Details on → Page 82+83.

7

ModuSet – Milling inserts without profile, ground ready-for-use

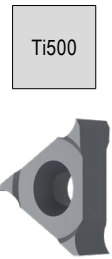
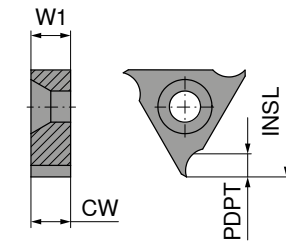

Solid carbide
50 851 ...

Size	CW _{-0,02} mm	PDPT mm	INSL mm	W1 mm	
03	2,34	1,60	10,6	2,34	304
	3,00	1,60	10,6	3,00	306
02	3,50	2,60	17,5	3,50	312
	5,00	2,60	17,5	5,00	314
	6,00	2,60	17,5	6,00	316
01	4,00	3,45	23,0	4,00	322 ¹⁾
	6,50	3,45	23,0	6,50	324 ¹⁾

P	●
M	●
K	●
N	●
S	●
H	○
O	●

1) with circular milling cutter 50 800 090 PDPT = 3.0 mm

→ v_c/f_z Page 80

ModuSet – Milling inserts for chamfering and deburring

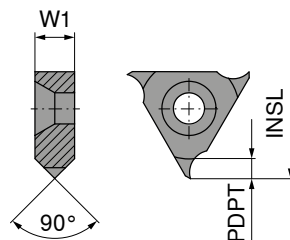

Solid carbide
50 857 ...

Size	PDPT mm	INSL mm	W1 mm	
03	1,50	10,6	3,0	304
02	2,50	17,5	5,0	314
01	3,25	23,0	6,5	322 ¹⁾

P	●
M	●
K	●
N	●
S	●
H	○
O	●

1) with circular milling cutter 50 800 090 PDPT = 3.0 mm

→ v_c/f_z Page 80

When calculating the feedrate for circular milling it is important to know whether contour feed v_c or feed on the center path v_{fm} is used. Details on → Page 82+83.

ModuSet – Thread milling insert – Partial profile

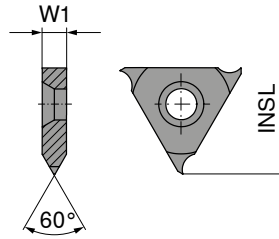
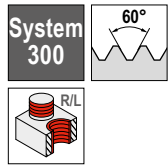

Solid carbide

50 855 ...

Size	TP mm	INSL mm	W1 mm
02	1 - 3,5	17,5	3,5
01	1 - 4,0	23,0	4,0

314
324

P	•
M	•
K	•
N	•
S	•
H	○
O	•

→ v_c/f_z Page 80

7

ModuSet – Thread milling insert – Full profile

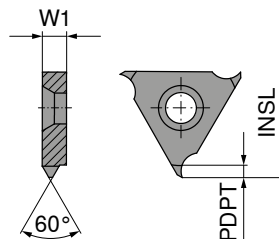
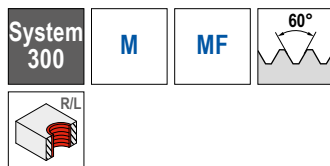

Solid carbide

50 859 ...

Size	TP mm	INSL mm	W1 mm	PDPT mm
03	1,0	10,6	2,34	0,578
	1,5	10,6	2,34	0,864
	2,0	10,6	2,34	1,159
02	1,0	17,5	3,50	0,578
	1,5	17,5	3,50	0,864
	2,0	17,5	3,50	1,159
	2,5	16,0	3,50	1,444
	3,0	17,5	3,50	1,728
01	1,0	23,0	4,00	0,578
	1,5	23,0	4,00	0,864
	2,0	23,0	4,00	1,159
	2,5	23,0	4,00	1,444
	3,0	23,0	4,00	1,728
	3,5	23,0	4,00	2,023
	4,0	23,0	4,00	2,308
	4,5	23,0	6,50	2,602
	5,0	23,0	6,50	2,887
	6,0	23,0	6,50	3,467

304
308
310
311
312
314
317¹⁾
316
318
320
322
324
326
328
330
332
334
336
338²⁾

P	•
M	•
K	•
N	•
S	•
H	○
O	•

1) M20x2,5 – profile corrected

2) with circular milling cutter 50 800 090 PDPT = 3.0 mm

→ v_c/f_z Page 80

ModuSet – Thread milling insert – Full profile

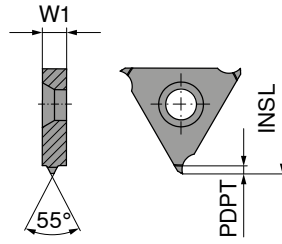

Solid carbide

50 858 ...

Size	TP mm	TPI 1/"	INSL mm	W1 mm	PDPT mm	
02	1,814	14	17,5	3,5	1,162	314
	2,309	11	17,5	3,5	1,494	312
01	2,309	11	23,0	4,0	1,494	322
P						●
M						●
K						●
N						●
S						●
H						○
O						●

→ v_c/f_z Page 80

i When calculating the feedrate for circular milling it is important to know whether contour feed v_f or feed on the center path v_{fm} is used. Details on → **Page 82+83.**

ModuSet – Circular milling cutter

▲ Size refers to milling inserts

Scope of supply:
including key

**System
300**

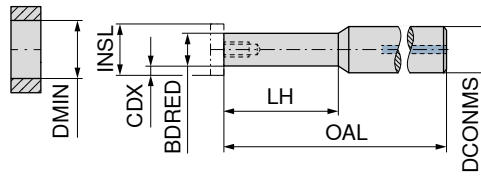

50 800 ...

Size	INSL mm	CDX mm	LH mm	DCONMS _{h6} mm	OAL mm	BDRED mm	DMIN mm	torque moment		
								Nm		
03	10,6	1,60	17,2	10	57,20	7,4	11	0,9		020 ¹⁾
	10,6	1,60	34,2	10	74,20	7,4	11	0,9		025 ²⁾
02	17,5	2,60	28,7	12	74,05	12,0	20	3,8		030
	17,5	2,60	63,7	12	108,70	12,0	20	3,8		045 ²⁾
01	23,0	3,45	38,5	16	87,00	16,1	25	5,5		050
	23,0	3,45	67,5	16	116,00	16,1	25	5,5		070
	23,0	3,00	88,5	16	137,00	17,0	25	5,5		090 ²⁾

- 1) Without Through Coolant
- 2) Carbide version

7

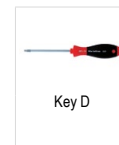

Key D



Clamping screw

80 950 ...

70 960 ...

Spare parts
Size

03	T06 - IP	123	M2x9	232
02	T15 - IP	128	M4x12,3	233
01	T20 - IP	129	M5x15	234

When calculating the feedrate for circular milling it is important to know whether contour feed v_f or feed on the center path v_{fm} is used. Details on → **Page 82+83.**

ModuThread – Thread milling insert

▲ Can be used on both sides (except for INSL 10.4)

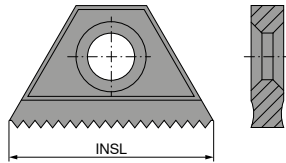

TiAlN

TiAlN

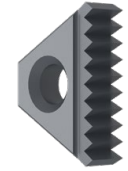
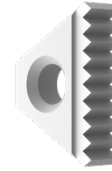
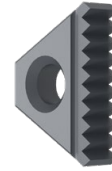
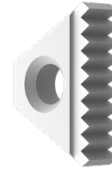

Solid carbide

Solid carbide

Solid carbide

Solid carbide

50 890 ...

50 890 ...

50 891 ...

50 891 ...

INSL mm	TP mm	50 890 ...	50 890 ...	50 891 ...	50 891 ...
10,4	0,50	100			
	0,75	101			
	1,00	102	302		
	1,25	103			
	1,50	104	304		
11,0	0,50	120			
	0,75	121			
	1,00	122	322		
	1,25	123			
	1,50	124	324		
16,0	0,50	140			
	0,75	141			
	1,00	142	342	142	342
	1,25	143		143	342
	1,50	144	344	144	344
	1,75	145		145	344
	2,00	146	346	146	346
27,0	1,00	162	362	162	362
	1,25	163		163	362
	1,50	164	364	164	364
	1,75	165		165	364
	2,00	166	366	166	366
	2,50	167		167	366
	3,00	168	368	168	368
	3,50	169		169	368
	4,00	170		170	368
P		●	●	●	●
M		○	●	○	●
K		●	●	●	●
N		●	●	●	●
S					
H					
O		●	○	●	○

→ v_c/f_z Page 79



When calculating the feedrate for circular milling it is important to know whether contour feed v_r or feed on the center path v_{im} is used. Details on → Page 82+83.

ModuThread – Thread milling insert

▲ Can be used on both sides (except for INSL 10.4)

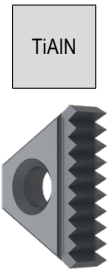
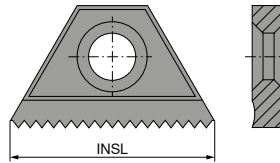
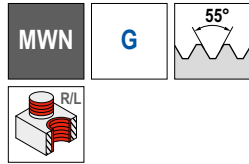

TiAlN
Solid carbide
50 895 ...

INSL mm	TPI 1/"	TP mm	
10,4	19	1,337	300
16,0	14	1,814	342
	11	2,309	344
27,0	11	2,309	366
P			●
M			●
K			●
N			●
S			●
H			●
O			○

→ v_c/f_z Page 79

7

ModuThread – Thread milling insert

▲ Can be used on both sides (except for INSL 10.4)

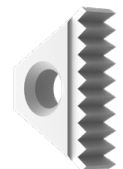
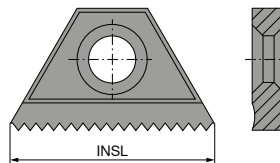
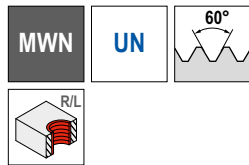

Solid carbide
50 892 ...

INSL mm	TPI 1/"	TP mm	
10,4	20	1,270	100
	18	1,411	102
16,0	16	1,588	144
	12	2,117	146
27,0	12	2,117	166
	8	3,175	168
P			●
M			○
K			●
N			●
S			●
H			●
O			●

→ v_c/f_z Page 79

When calculating the feedrate for circular milling it is important to know whether contour feed v_f or feed on the center path v_{fm} is used. Details on → Page 82+83.

ModuThread – Thread milling insert

▲ double sided

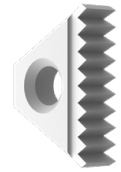
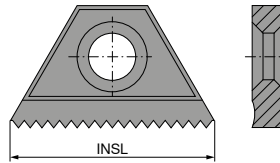
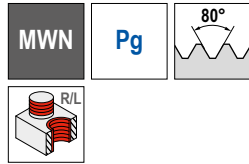

Solid carbide

50 896 ...

INSL mm	TPI 1/"	TP mm	
16	18	1,411	142
	16	1,588	144

P	●
M	○
K	●
N	●
S	●
H	●
O	●

→ v_c/f_z Page 79

ModuThread – Thread milling insert

▲ double sided

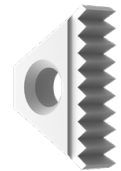
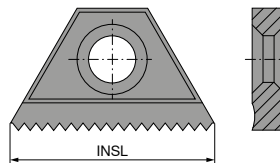
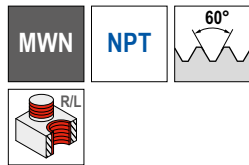

Solid carbide

50 897 ...

INSL mm	TPI 1/"	TP mm	
16	14,0	1,814	142
	11,5	2,209	144

27	11,5	2,209	164
	8,0	3,175	166

P	●
M	○
K	●
N	●
S	●
H	●
O	●

→ v_c/f_z Page 79

i Note! Thread milling inserts are marked R (right-hand thread) and L (left-hand thread). The standard tool holder cannot be used to produce a left-hand thread! Tool holder for left-hand thread available on special request.

i When calculating the feedrate for circular milling it is important to know whether contour feed v_r or feed on the center path v_m is used. Details on → Page 82+83.

ModuThread – Circular milling cutter

▲ INSL refers to milling inserts

Scope of supply:
includes key

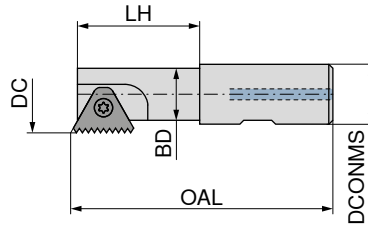
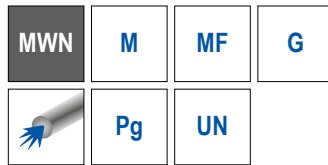

50 843 ...

INSL mm	BD mm	LH mm	DCONMS mm	OAL mm	DC mm	torque moment Nm	
10,4	6,8	12	12	69	9,0	0,9	101
	6,8	17	20	84	9,0	0,9	102
11,0	8,9	12	12	70	11,5	1,2	111
	8,9	20	20	85	11,5	1,2	112
16,0	13,6	22	16	90	17,0	2,5	161
	16,6	43	20	95	20,0	2,5	162
	18,6	25	25	125	22,0	2,5	163
27,0	24,0	52	25	110	30,0	9,0	271
	31,0	58	32	120	37,0	9,0	273
	24,0	92	25	150	30,0	9,0	272
	31,0	98	32	160	37,0	9,0	274

7

Pilot hole diameter for circular end mill 50 843 ...

BD	TP in mm									
	0,5 mm 48 G/"	0,75 mm 32 G/"	1,0 mm 24 G/"	1,25 mm 20 G/"	1,5 mm 16 G/"	2,0 mm 12 G/"	2,5 mm 10 G/"	3,0 mm 8 G/"	3,5 mm 7 G/"	4,0 mm 6 G/"
6,8	9,5	10	10,7	11,4	12					
8,9	12	12,5	13,2	13,9	14,5					
13,6	17,6	18,2	19	19,6	20	21				
16,6	20,7	21,4	22	22,6	23	24				
18,6	22,7	23,4	24	24,6	25	26				
24,0	30,7	31,4	32	32,8	33,5	34,6	36,6	39	42	45
31,0	38	38,6	39,5	40,4	41	42	44	46,5	49	52

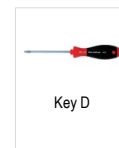

80 950 ...

70 950 ...

Spare parts

INSL				
10,4		T07	109	M2,2x5,0
11		T08	110	M2,6x6,5
16		T10	112	UNC5-40 x 8
27		T25	115	M5x15
				200
				201
				202
				203

ModuThread – Circular milling cutter

▲ INSL refers to milling inserts

Scope of supply:
includes key

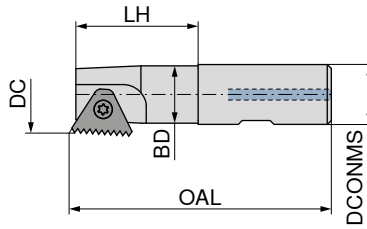

50 844 ...

INSL mm	BD mm	Thread	LH mm	DCONMS _{h6} mm	OAL mm	DC mm	torque moment Nm	
16	12,5	NPT 1/2	22	16	90	15,5	2,5	161
	15,0	NPT 3/4 - 1 1/4	23	20	85	19,0	2,5	162
27	24,0	NPT 1 1/2 - 2	52	25	110	30,0	9,0	271
	31,0	NPT > 2	58	32	120	37,0	9,0	272

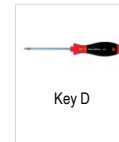

Key D

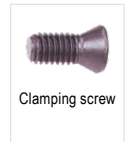

Clamping screw

80 950 ...

70 950 ...

Spare parts

INSL				
16	T10	112	UNC5-40 x 8	202
27	T25	115	M5x15	203

i When calculating the feedrate for circular milling it is important to know whether contour feed v_f or feed on the center path v_{fm} is used. Details on → Page 82+83.

ModuThread – Thread milling insert

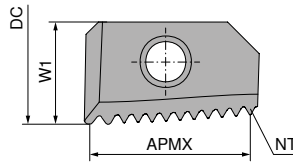
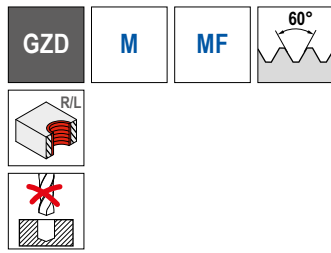

Solid carbide

50 863 ...

DC mm	TP mm	W1 mm	APMX mm	NT	
12	1,0	7,5	12,0	13	300
	1,5	7,5	10,5	8	302
17	1,0	11,0	16,0	17	310
	1,5	11,0	16,5	12	312
	2,0	11,0	16,0	9	314
20	1,0	7,5	12,0	13	320
	1,5	7,5	10,5	8	322
25	1,0	11,0	16,0	17	330
	1,5	11,0	16,5	12	332
	2,0	11,0	16,0	9	334

P	•
M	•
K	•
N	•
S	
H	
O	

→ v_c/f_z Page 79

7

ModuThread – Thread milling insert

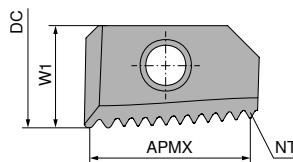
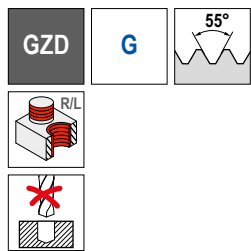

Solid carbide

50 864 ...

DC mm	TPI 1/"	W1 mm	APMX mm	NT	
12	14	7,5	9,07	6	300
17	14	11,0	16,33	10	312 ¹⁾
	14	11,0	16,33	10	314 ²⁾
	11	11,0	16,16	8	310
25	14	11,0	16,33	10	332
	11	11,0	16,16	8	330

P	•
M	•
K	•
N	•
S	
H	
O	

1) Thread: 5/8 – 3/4 – 7/8
2) 1/2" Profile corrected

→ v_c/f_z Page 79

ModuThread – Circular milling cutter

Scope of supply:
includes key

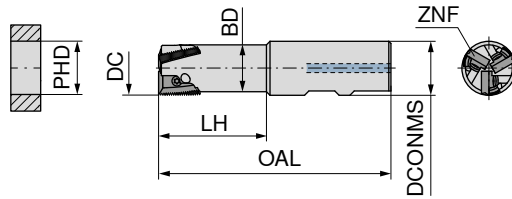
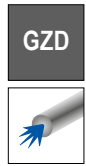

50 842 ...	121
	171
	201
	251
	252 ¹⁾

DC mm	LH mm	DCONMS _{h6} mm	OAL mm	BD mm	ZNF	PHD mm	torque moment Nm
12	18	16	74,0	9,4	1	14	1,1
17	30	16	79,0	13,7	1	19	3,8
20	32	20	83,0	17,5	3	22	1,1
25	50	25	107,6	21,7	3	26	3,8
	85	25	142,6	21,7	3	26	3,8

1) Heavy metal version with mounted head

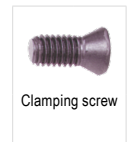

80 950 ...	70 960 ...
T08 - IP	M2,5x6,5
T15 - IP	M4x7,5
T08 - IP	M2,5x6,5
T15 - IP	M4x7,5

Spare parts
DC

12	T08 - IP	125	M2,5x6,5	244
17	T15 - IP	128	M4x7,5	245
20	T08 - IP	125	M2,5x6,5	244
25	T15 - IP	128	M4x7,5	245

When calculating the feedrate for circular milling it is important to know whether contour feed v_f or feed on the center path v_{fm} is used. Details on → Page 82+83.

ModuThread – Thread milling insert

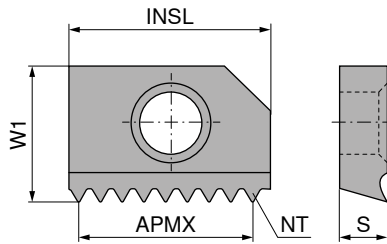

Solid carbide

Solid carbide

INSL mm	TP mm	W1 mm	APMX mm	S mm	NT
14,5	0,50	10,0	13,50	3,18	28
	0,75	10,0	13,50	3,18	19
	1,00	10,0	13,00	3,18	14
	1,25	10,0	12,50	3,18	11
	1,50	10,0	12,00	3,18	9
	1,75	10,0	12,25	3,18	8
	2,00	10,0	12,00	3,18	7
	2,50	10,0	10,00	3,18	5
15,0	3,00	10,5	12,00	3,18	5
	3,50	10,5	10,50	3,18	4
21,0	1,00	10,0	19,00	3,18	20
	1,50	10,0	19,50	3,18	14
	1,50	10,0	18,00	3,18	13
	2,00	10,0	18,00	3,18	10
26,0	1,50	15,0	24,00	5,00	17
	2,00	15,0	24,00	5,00	13
	3,00	15,0	21,00	5,00	8
	3,50	15,0	20,00	5,00	7
	4,00	15,0	20,00	5,00	6

50 887 ...	50 885 ...
	350
	352
304	354
	356
308	358
	360
312	362
	364
	366 ¹⁾
	370 ²⁾
	372 ²⁾
	380
320	382
	384
	390
	392
	396
	398
	400

P	•	•
M	•	•
K	•	•
N	•	•
S	•	•
H		
O		

1) M20x2,5 – profile corrected
2) Without chamfer

→ v_c/f_z Page 79

When calculating the feedrate for circular milling it is important to know whether contour feed v_f or feed on the center path v_{fm} is used. Details on → Page 82+83.

ModuThread – Thread milling insert

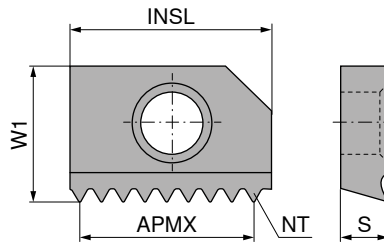

Solid carbide

50 888 ...

INSL mm	TPI 1/"	TP mm	W1 mm	APMX mm	S mm	NT	
14,5	18	1,411	10	11,28	3,18	9	310
	16	1,587	10	11,11	3,18	8	312
	14	1,814	10	12,69	3,18	8	314
	12	2,116	10	10,58	3,18	6	316
	11	2,309	10	11,54	3,18	6	318
21,0	14	1,814	10	18,14	3,18	11	320
	11	2,309	10	18,47	3,18	9	322
26,0	11	2,309	15	23,09	5,00	11	330

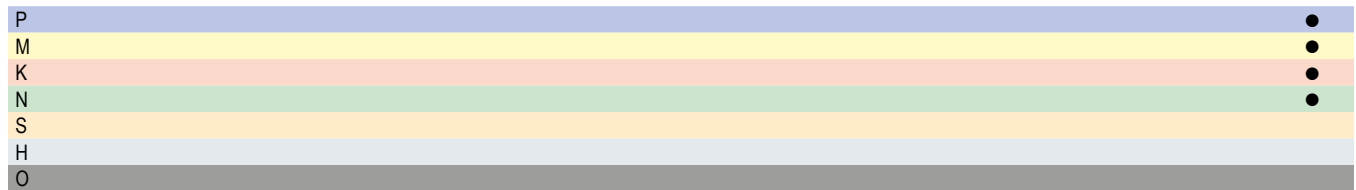

→ v_c/f_z Page 79

ModuThread – Thread milling insert

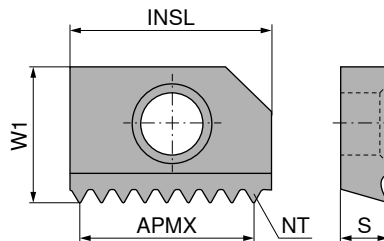
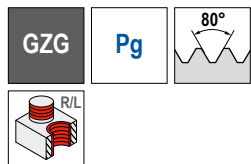

Solid carbide

50 894 ...

INSL mm	TPI 1/"	TP mm	W1 mm	APMX mm	S mm	NT	
14,5	18	1,411	10	12,69	3,18	10	302
	16	1,587	10	11,11	3,18	8	304

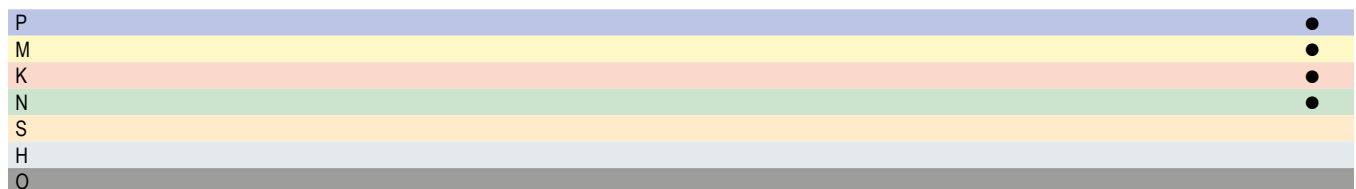

→ v_c/f_z Page 79

When calculating the feedrate for circular milling it is important to know whether contour feed v_f or feed on the center path v_{m} is used. Details on → Page 82+83.

ModuThread – Thread milling insert

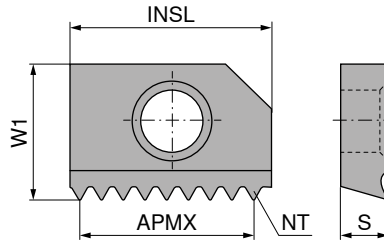
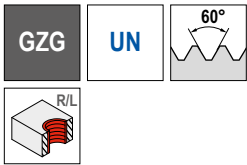

Solid carbide

50 889 ...

INSL mm	TPI 1/"	TP mm	W1 mm	APMX mm	S mm	NT	
14,5	18	1,411	10	12,69	3,18	10	310
	16	1,587	10	12,70	3,18	9	312
21,0	16	1,587	10	19,05	3,18	13	320
	14	1,814	10	18,14	3,18	11	322
	12	2,116	10	18,04	3,18	10	324
P							•
M							•
K							•
N							•
S							•
H							•
O							•

→ v_c/f_z Page 79

i When calculating the feedrate for circular milling it is important to know whether contour feed v_f or feed on the center path v_{fm} is used. Details on → Page 82+83.

7

ModuThread – Circular milling cutter

▲ INSL refers to milling inserts

Scope of supply:
includes key

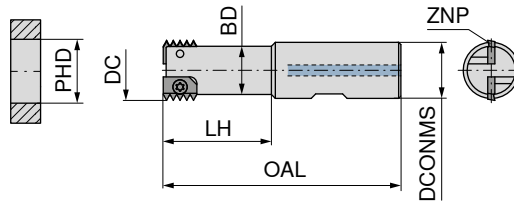

50 841 ...

INSL mm	DC mm	LH mm	DCONMS _{h6} mm	OAL mm	BD mm	ZNP	PHD mm	torque moment Nm	
14,5	16	30,0	16	78	12,7	1	18,5	3,8	016
	16	50,0	16	98	12,7	1	18,5	3,8	017 ¹⁾
	20	60,0	20	110	16,8	1	23,0	3,8	020
	25	48,2	25	106	21,5	2	30,0	3,8	025
	25	92,2	25	150	21,5	2	30,0	3,8	026 ¹⁾
15,0	18	30,0	16	79	12,7	1	20,0	3,8	218
	22	60,0	20	110	16,8	1	26,0	3,8	222
	27	48,2	25	106	21,5	2	32,0	3,8	227
21,0	16	31,3	20	85	12,7	1	18,5	3,8	316
	22	32,8	25	92	18,7	1	26,0	3,8	322
	22	62,8	25	122	18,7	1	26,0	3,8	323 ¹⁾
	28	38,3	32	102	24,7	2	35,0	3,8	328
	28	78,3	32	142	24,5	2	35,0	3,8	327 ¹⁾
26,0	25	48,5	25	107	20,0	1	30,0	3,8	125

1) Heavy metal version



Key D



Clamping screw

80 950 ...

70 960 ...

Spare parts
for Article no.

50 841 016	T15 - IP	128	M4x6,9	237
50 841 017	T15 - IP	128	M4x6,9	237
50 841 020	T15 - IP	128	M4x7,5	245
50 841 025	T15 - IP	128	M4x8	242
50 841 026	T15 - IP	128	M4x8	242
50 841 218	T15 - IP	128	M4x6,9	237
50 841 222	T15 - IP	128	M4x6,9	237
50 841 227	T15 - IP	128	M4x8	242
50 841 316	T15 - IP	128	M4x6,9	237
50 841 322	T15 - IP	128	M4x6,9	237
50 841 323	T15 - IP	128	M4x8	242
50 841 328	T15 - IP	128	M4x8	242
50 841 327	T15 - IP	128	M4x8	242
50 841 125	T15 - IP	128	M4x11,5	241

When calculating the feedrate for circular milling it is important to know whether contour feed v_f or feed on the center path v_{fm} is used. Details on → Page 82+83.

ModuThread – Thread milling insert – partial profile

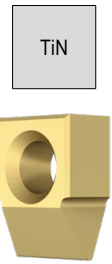
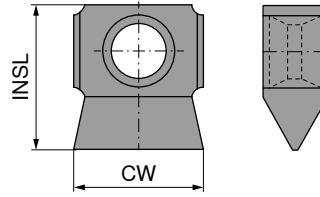
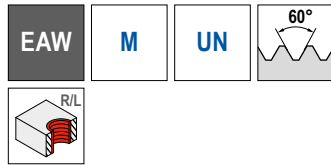

TiN
Solid carbide
50 867 ...
115
225

DC mm	TP mm	TPI 1/"	CW mm	INSL mm
16,5	1,5 - 3,0	16 - 10	5	7,0
18	2,5 - 3,5	10 - 7	5	7,8



Solid carbide
50 868 ...
114

DC mm	TP mm	TPI 1/"	CW mm	INSL mm
16,5	1,814	14	5	7

ModuThread – Thread milling insert – partial profile

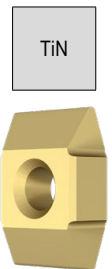
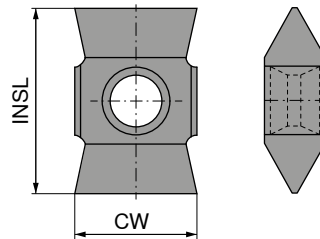
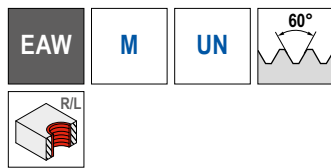

TiN
Solid carbide
50 860 ...
315
325
415
425

DC mm	TP mm	TPI 1/"	CW mm	INSL mm
23,85	1,5 - 2,5	16 - 10	6,35	9,52
23,85	2,5 - 4,0	10 - 6	6,35	9,52
32,85	1,5 - 2,5	16 - 10	8,50	13,50
32,85	2,5 - 5,5	10 - 4,5	8,50	13,50



Solid carbide
50 861 ...
311
411

DC mm	TP mm	TPI 1/"	CW mm	INSL mm
23,85	2,309	11	6,35	9,52
32,85	2,309	11	8,50	13,50

P	●
M	●
K	●
N	●
S	●
H	○
O	○

ModuThread – Circular milling cutter

Scope of supply:
including key

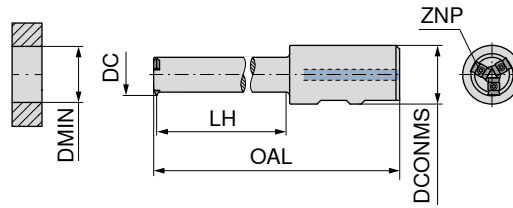

50 848 ...

DC mm	DMIN mm	TP mm	TPI 1/"	LH mm	DCONMS _{h6} mm	OAL mm	ZNP	torque moment Nm	
16,5 / 18,0	17,5 / 19,0	1,5 - 3,5	16 - 10	60	20	114	2	0,9	020
23,85	25,5	1,5 - 4,0	24 - 6	90	32	154	3	0,9	030
32,85	35,0	1,5 - 5,5	16 - 4,5	115	32	179	3	2,5	040

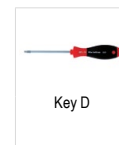

Key D



Clamping screw

80 950 ...

70 950 ...

**Spare parts
for Article no.**

50 848 020	T07 - IP	124	M2,5x8,5	739
50 848 030	T07 - IP	124	M2,5x8,5	739
50 848 040	T09 - IP	126	M3x11	740

 When calculating the feedrate for circular milling it is important to know whether contour feed v_f or feed on the center path v_{fm} is used. Details on → **Page 82+83.**

ModuThread – Thread milling insert – partial profile

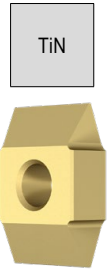
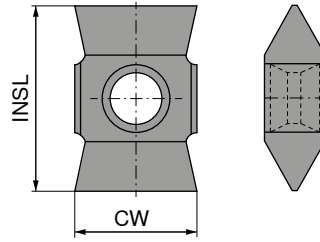
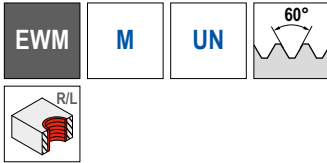

Solid carbide

50 870 ...

DC mm	TP mm	TPI 1/"	CW mm	INSL mm	
40,25	1,5 - 3,0	16 - 9	9,5	15,50	515
40,25	3,0 - 6,0	9 - 4	9,5	15,50	530
52,55 / 66,55	1,5 - 3,0	16 - 9	12,5	19,00	615
52,55 / 66,55	3,0 - 6,0	9 - 4	12,5	19,00	630
92	6,0 - 8,0	4	14,3	28,58	760

P	●
M	●
K	●
N	●
S	●
H	○
O	○

→ v_c/f_z Page 79

When calculating the feedrate for circular milling it is important to know whether contour feed v_f or feed on the center path v_{fm} is used. Details on → Page 82+83.

7

ModuThread – Circular milling cutter

Scope of supply:
including key

EWM

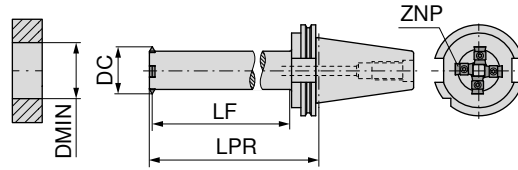

DIN 69871

50 849 ...

DC mm	DMIN mm	TP mm	TPI 1/"	LF mm	LPR mm	Adapter	ZNP	torque moment Nm	
40,25	43,0	1,5 - 6,0	16 - 4,0	145	178,7	SK 50	4	5,5	148
40,25	43,0	1,5 - 6,0	16 - 4,0	145	178,7	SK 40	4	5,5	048
52,55	56,0	1,5 - 6,0	16 - 4,0	195	229,2	SK 50	4	8,0	164
66,55	70,5	1,5 - 6,0	16 - 4,0	260	296,2	SK 50	7	8,0	080
92,00	100,0	6,0 - 8,0	4,0	360	395,0	SK 50	7	8,0	115

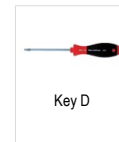

80 950 ...



70 950 ...

Spare parts
DC

40,25	T15 - IP	128	M4x13	741
52,55 - 92	T20 - IP	129	M5x15	742

When calculating the feedrate for circular milling it is important to know whether contour feed v_f or feed on the center path v_{fm} is used. Details on → Page 82+83.

MonoThread – Solid Carbide Circular End Milling Cutter

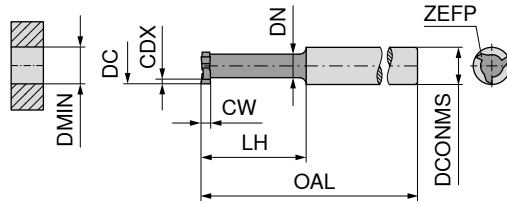

Solid carbide

53 050 ...

DC mm	CW $\pm 0,02$ mm	CDX mm	LH mm	OAL mm	DN mm	DCONMS h_6 mm	ZEFP	DMIN mm	
5,8	0,7	0,8	15,2	58	3,8	6	3	6	070
	0,8	0,8	15,2	58	3,8	6	3	6	080
	0,9	0,8	15,2	58	3,8	6	3	6	090
	1,0	0,8	15,2	58	3,8	6	3	6	100
	1,5	0,8	15,2	58	3,8	6	3	6	150
7,8	0,7	1,2	25,4	68	5,0	8	3	8	170
	0,8	1,2	25,4	68	5,0	8	3	8	180
	0,9	1,2	25,4	68	5,0	8	3	8	190
	1,0	1,2	25,4	68	5,0	8	3	8	200
	1,5	1,2	25,4	68	5,0	8	3	8	250
	2,0	1,2	25,4	68	5,0	8	3	8	300

P	•
M	•
K	•
N	•
S	•
H	•
O	•

→ v_c/f_z Page 81

7

MonoThread – Solid Carbide Circular End Milling Cutter

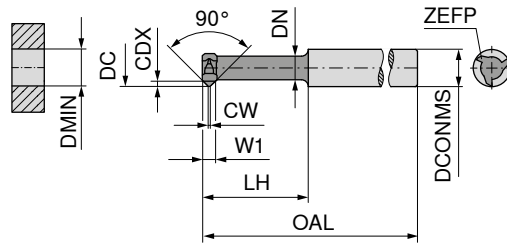

Solid carbide

53 051 ...

DC mm	W1 mm	CW mm	CDX mm	LH mm	OAL mm	DN mm	DCONMS h_6 mm	ZEFP	DMIN mm	
5,8	2	0,2	0,8	15	58	4,2	6	3	6	010
	2	0,2	0,8	25	68	4,2	6	3	6	020
7,8	2	0,2	1,2	25	68	5,0	8	3	8	110
	2	0,2	1,2	35	78	5,0	8	3	8	120

P	•
M	•
K	•
N	•
S	•
H	•
O	•

→ v_c/f_z Page 81

MonoThread – Solid Carbide Circular Thread Milling Cutter – Full profile

▲ Profile corrected

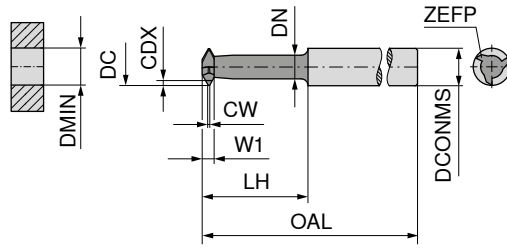

CWX500



Solid carbide

53 052 ...

DC mm	Thread	TP mm	W1 mm	CW mm	CDX mm	LH mm	OAL mm	DN mm	DCONMS _{h6} mm	ZEFP	DMIN mm	
1,18	M1,6	0,35	0,40	0,04	0,19	4,0	32	0,64	3	3	1,38	160
1,38	M1,8	0,35	0,50	0,04	0,19	5,0	32	0,70	3	3	1,58	180
1,50	M2	0,40	0,56	0,05	0,22	5,0	32	0,90	3	4	1,70	200
1,95	M2,5	0,45	0,60	0,06	0,25	6,0	32	1,15	3	4	2,15	250
2,40	M3	0,50	0,60	0,06	0,27	7,0	32	1,60	3	4	2,60	300
2,80	M3,5	0,60	0,74	0,08	0,33	8,0	32	1,80	3	4	3,00	350
3,10	M4	0,70	0,82	0,09	0,38	9,0	44	1,98	5	4	3,30	400
3,60	M5	0,80	0,98	0,10	0,43	10,0	44	2,20	5	4	3,80	500
4,10	M6	1,00	0,98	0,13	0,54	12,2	44	2,70	5	4	4,30	600

P	●
M	●
K	●
N	●
S	●
H	●
O	●

→ v_c/f_z Page 81

MonoThread – Solid Carbide Circular Thread Milling Cutter – Partial profile

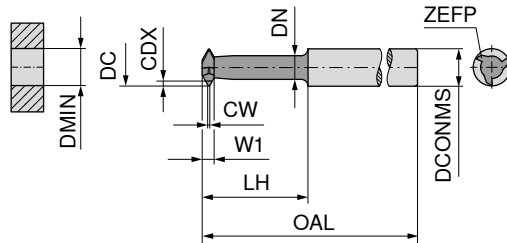
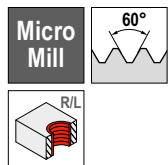

CWX500



Solid carbide

53 053 ...

DC mm	TP mm	W1 mm	CW mm	CDX mm	LH mm	OAL mm	DN mm	DCONMS _{h6} mm	ZEFP	DMIN mm	
5,8	0,5 - 1,5	2	0,06	0,91	15,2	58	3,5	6	3	6	010
7,8	0,5 - 1,5	2	0,06	0,91	25,4	68	5,5	8	3	8	110
7,8	1,0 - 2,0	2	0,12	1,19	25,4	68	5,0	8	3	8	120

P	●
M	●
K	●
N	●
S	●
H	●
O	●

→ v_c/f_z Page 81

When calculating the feedrate for circular milling it is important to know whether contour feed v_r or feed on the center path v_m is used. Details on → Page 82+83.

MonoThread – Drill thread milling cutter with chamfer facet

▲ Profile corrected

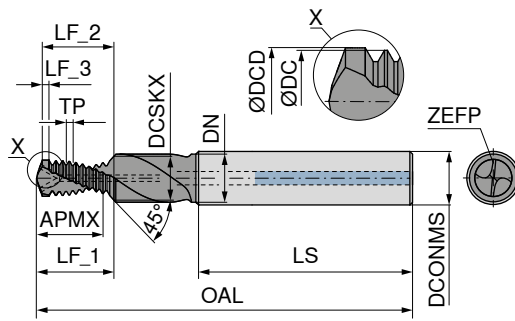
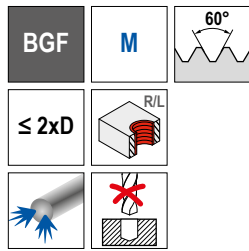

DC mm	Thread	KOMET no.	TP mm	OAL mm	APMX mm	LS mm	DCONMS _{h6} mm	DCD mm	DCSKX mm	DN mm	LF_1 mm	LF_2 mm	LF_3 mm	ZEPF	50 869 ...	50 854 ...
2,45	M3	88901001000013	0,50	49	5,8	36	6	2,5	3,3	4,5	6,8	6,4	0,5	2	03000 ¹⁾	
2,45	M3	88906001000013	0,50	49	5,8	36	6	2,5	3,3	4,5	6,8	6,4	0,5	2		03000 ¹⁾
3,24	M4	88941001000015	0,70	49	7,3	36	6	3,3	4,3	4,5	9,4	8,9	0,7	2	04000	04000
3,24	M4	88935001000015	0,70	49	7,3	36	6	3,3	4,3	4,5	9,4	8,9	0,7	2		04000
4,10	M5	88941001000017	0,80	55	9,2	36	6	4,2	5,3	5,5	11,7	11,0	0,8	2	05000	
4,10	M5	88935001000017	0,80	55	9,2	36	6	4,2	5,3	5,5	11,7	11,0	0,8	2		05000
4,85	M6	88941001000018	1,00	62	11,4	36	8	5,0	6,3	6,6	14,5	13,7	1,0	2	06000	
4,85	M6	88935001000018	1,00	62	11,4	36	8	5,0	6,3	6,6	14,5	13,7	1,0	2		06000
6,45	M8	88941001000020	1,25	74	14,2	40	10	6,8	8,3	9,0	18,2	17,1	1,3	2	08000	
6,45	M8	88935001000020	1,25	74	14,2	40	10	6,8	8,3	9,0	18,2	17,1	1,3	2		08000
8,08	M10	88941001000022	1,50	79	18,5	45	12	8,5	10,3	11,0	23,4	22,1	1,5	2	10000	
8,08	M10	88935001000022	1,50	79	18,5	45	12	8,5	10,3	11,0	23,4	22,1	1,5	2		10000
9,74	M12	88941001000024	1,75	89	21,6	45	14	10,3	12,3	13,5	27,1	25,5	1,5	2	12000	
9,74	M12	88935001000024	1,75	89	21,6	45	14	10,3	12,3	13,5	27,1	25,5	1,5	2		12000
11,35	M14	88941001000025	2,00	102	26,6	48	16	12,0	14,3	15,5	32,8	30,9	1,5	2	14000	
11,35	M14	88935001000025	2,00	102	26,6	48	16	12,0	14,3	15,5	32,8	30,9	1,5	2		14000
13,28	M16	88941001000026	2,00	102	30,6	48	18	14,0	16,3	17,5	37,1	35,0	1,5	2	16000	
13,28	M16	88935001000026	2,00	102	30,6	48	18	14,0	16,3	17,5	37,1	35,0	1,5	2		16000

1) Without Through Coolant



DC mm	Thread	KOMET no.	TP mm	OAL mm	APMX mm	LS mm	DCONMS _{h6} mm	DCD mm	DCSKX mm	DN mm	LF_1 mm	LF_2 mm	LF_3 mm	ZEPF	50 869 ...	50 854 ...
6,79	M8x1	88935002000070	1,0	74	15,40	40	10	7,0	8,3	9,0	18,8	17,7	1,0	2		08100
6,79	M8x1	88941002000070	1,0	74	15,40	40	10	7,0	8,3	9,0	18,8	17,7	1,0	2	08100	
8,75	M10x1	88941002000094	1,0	79	19,40	45	12	9,0	10,3	11,0	23,2	21,8	1,0	2	10100	
8,75	M10x1	88935002000094	1,0	79	19,40	45	12	9,0	10,3	11,0	23,2	21,8	1,0	2		10100
10,74	M12x1	88935002000111	1,0	89	22,40	45	14	11,0	12,3	13,5	26,4	24,8	1,0	2		12100
10,06	M12x1,5	88935002000113	1,5	89	23,01	45	14	10,5	12,3	13,5	28,2	26,6	1,5	2		12200
10,06	M12x1,5	88941002000113	1,5	89	23,01	45	14	10,5	12,3	13,5	28,2	26,6	1,5	2	12200	

P		
M		
K	○	●
N	●	○
S		
H		
O	●	○

→ v_c/f_z Page 76

When calculating the feedrate for circular milling it is important to know whether contour feed v_c or feed on the center path v_{im} is used. Details on → Page 82+83.

MonoThread – Drill thread milling cutter with chamfer facet

▲ Profile corrected

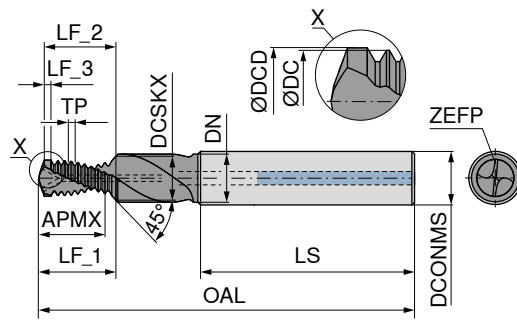
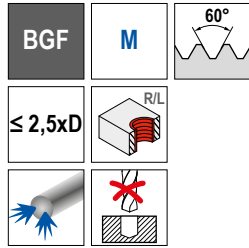

DC mm	Thread	KOMET no.	TP mm	OAL mm	APMX mm	LS mm	DCONMS _{h6} mm	DCD mm	DCSKX mm	DN mm	LF_1 mm	LF_2 mm	LF_3 mm	ZEPF	50 898 ...	50 862 ...
4,10	M5	88961001000017	0,80	55	11,57	36	6	4,2	5,3	5,5	14,1	13,4	0,8	2	05000 ¹⁾	
4,85	M6	88961001000018	1,00	62	13,40	36	8	5,0	6,3	6,6	16,5	15,7	1,0	2	06000	
4,85	M6	88956001000018	1,00	62	13,40	36	8	5,0	6,3	6,6	16,5	15,7	1,0	2		06000
6,45	M8	88961001000020	1,25	74	19,20	40	10	6,8	8,3	9,0	23,2	22,1	1,3	2	08000	
6,45	M8	88956001000020	1,25	74	19,20	40	10	6,8	8,3	9,0	23,2	22,1	1,3	2		08000
8,08	M10	88961001000022	1,50	79	23,00	45	12	8,5	10,3	11,0	27,9	26,6	1,5	2	10000	
8,08	M10	88956001000022	1,50	79	23,00	45	12	8,5	10,3	11,0	27,9	26,6	1,5	2		10000
9,74	M12	88961001000024	1,75	89	28,60	45	14	10,3	12,3	13,5	34,1	32,5	1,5	2	12000	
9,74	M12	88956001000024	1,75	89	28,60	45	14	10,3	12,3	13,5	34,1	32,5	1,5	2		12000

P																
M																
K															○	●
N															●	○
S																
H																
O															●	○

1) Not ex-stock

When calculating the feedrate for circular milling it is important to know whether contour feed v_f or feed on the center path v_{fm} is used. Details on → Page 82+83.

MonoThread – Circular Thread Milling Cutter

▲ Note: left-hand cutting (M04)

▲ Profile corrected

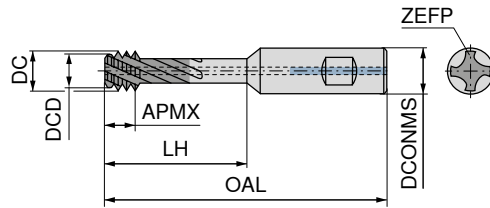
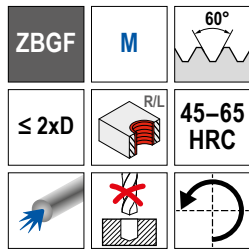

Solid carbide

50 840 ...

DC mm	Thread	TP mm	APMX mm	LH mm	DCONMS _{h6} mm	DCD mm	OAL mm	ZEFP	
2,3	M3x0,5	0,50	2,0	7,0	6	2,10	51	4	030 ¹⁾
3,0	M4x0,7	0,70	2,8	9,4	6	2,60	51	4	040 ¹⁾
3,8	M5x0,8	0,80	3,2	11,6	6	3,40	51	4	050 ¹⁾
4,6	M6x1 - M7x1	1,00	4,0	14,0	8	4,10	60	4	060 ¹⁾
6,2	M8x1,25 - M10x1,25	1,25	5,0	19,0	10	5,60	71	4	080
7,8	M10x1,5 - M12x1,5	1,50	6,0	25,0	10	7,00	76	4	100
9,2	M12x1,75	1,75	7,0	31,0	12	8,30	86	4	120
11,1	M14x2 - M16x2	2,00	8,0	36,0	16	10,04	98	4	140

P
M
K
N
S
H
O

1) Without Through Coolant

→ v_c/f_z Page 76

i When calculating the feedrate for circular milling it is important to know whether contour feed v_f or feed on the center path v_{fm} is used. Details on → Page 82+83.

i Caution: left-hand cutting (M04) → spindle rotation left!

MonoThread – Thread Milling Cutter

▲ Available on request from M3

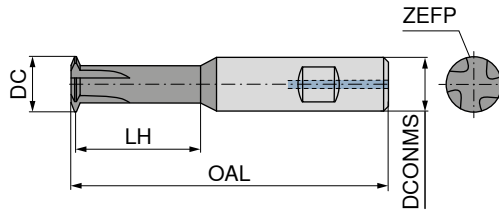
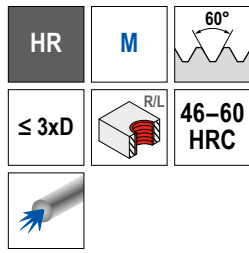

Solid carbide Solid carbide

DC mm	Thread	TP mm	LH mm	DCONMS _{h6} mm	OAL mm	ZEFP	50 546 ...	50 547 ...
3,14	M4	0,70	9	6	55	3	04000	04000
3,95	M5	0,80	11	6	55	3	05000	05000
4,68	M6 - M7	1,00	16	8	60	3	06000	06000
6,22	M8 - M9	1,25	22	10	71	4	08000	08000
7,79	M10 - M12	1,50	26	10	76	4	10000	10000
9,38	M12	1,75	27	12	86	4	12000	12000
P							○	○
M							○	○
K							○	○
N							○	○
S							○	○
H							●	●
O							○	○

→ v_c/f_z Page 76

Other dimensions are available on request.

MonoThread – Shank thread milling cutter with shank-end countersink

▲ Note: left-hand cutting
▲ Profile corrected

SFSE Micro M 60°

≤ 1,5xD 46-60 HRC

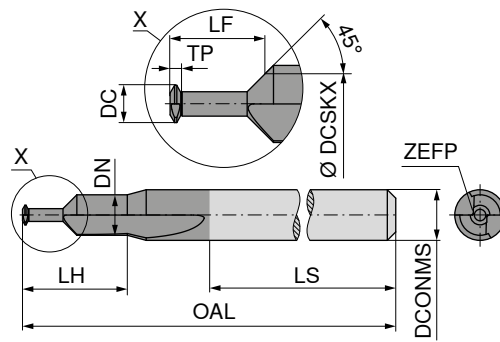

Ti602



Solid carbide

50 804 ...

DC mm	Thread	KOMET no.	TP mm	OAL mm	DN mm	LS mm	LH mm	DCONMS _{h6} mm	DCSKX mm	LF mm	ZEFP	
0,75	M1	88977001000001	0,25	40	1,8	28	5,2	3	1,5	2,1	2	01000
1,10	M1,4	88977001000004	0,30	40	2,0	28	5,7	3	1,7	2,6	2	01400
1,25	M1,6	88977001000005	0,35	40	2,4	28	6,0	3	2,1	3,1	2	01600
1,60	M2	88977001000008	0,40	40	3,0	28		3	2,6	3,7	2	02000
1,75	M2,2	88977001000009	0,45	40	3,0	28		3	2,5	3,9	2	02200
2,05	M2,5	88977001000011	0,45	40	3,0	28		3	2,9	4,5	2	02500

P	<input type="radio"/>
M	<input type="radio"/>
K	<input type="radio"/>
N	<input type="radio"/>
S	<input type="radio"/>
H	<input checked="" type="radio"/>
O	<input type="radio"/>

→ v_c/f_z Page 78

Caution: left-hand cutting (M04) → spindle rotation left!

7

MonoThread – Thread Milling Cutter with Chamfer Facet

▲ Profile corrected

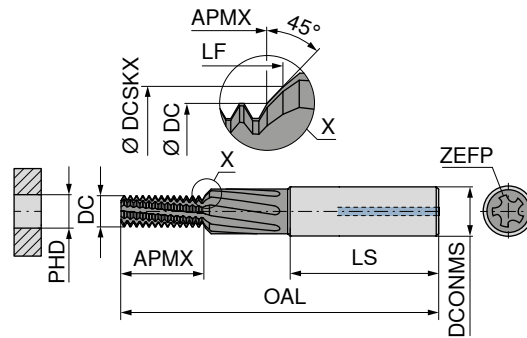
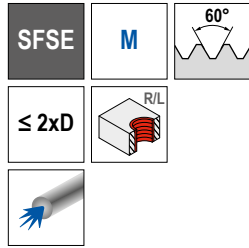

50 806 ...

DC mm	Thread	KOMET no.	TP mm	OAL mm	APMX mm	LS mm	DCONMS _{h6} mm	DCSKX mm	LF mm	ZEPF mm	PHD mm	
3,14	M4	88296001000015	0,70	49	8,0	36	6	4,3	8,6	5	3,3	04000
3,95	M5	88296001000017	0,80	55	9,9	36	6	5,3	10,6	5	4,2	05000
4,68	M6	88296001000018	1,00	62	12,3	36	8	6,3	13,2	6	5,0	06000
6,22	M8	88296001000020	1,25	74	16,6	40	10	8,3	17,8	7	6,8	08000
7,79	M10	88296001000022	1,50	79	19,9	45	12	10,3	21,3	7	8,5	10000
9,38	M12	88296001000024	1,75	89	24,9	45	14	12,3	26,6	7	10,2	12000
10,92	M14	88296001000025	2,00	102	28,5	48	16	14,3	30,4	7	12,0	14000
12,83	M16	88296001000026	2,00	102	32,4	48	18	16,3	34,4	8	14,0	16000



50 807 ...

DC mm	Thread	KOMET no.	TP mm	OAL mm	APMX mm	LS mm	DCONMS _{h6} mm	DCSKX mm	LF mm	ZEPF mm	PHD mm	
3,95	M5x0,5	88296002000037	0,50	55	10,2	36	6	5,3	10,8	5	4,5	05100
4,68	M6x0,75	88296002000048	0,75	62	12,2	36	8	6,3	13,0	5	5,2	06200
6,22	M8x1	88296002000070	1,00	74	16,2	40	10	8,3	17,3	6	7,0	08300
7,79	M10x1	88296002000094	1,00	79	20,1	45	12	10,3	21,5	7	9,0	10300
9,38	M12x1	88296002000111	1,00	89	24,0	45	14	12,3	25,6	7	11,0	12300
9,38	M12x1,5	88296002000113	1,50	89	24,3	45	14	12,3	25,9	7	10,5	12500
10,92	M14x1,5	88296002000131	1,50	102	28,7	48	16	14,3	30,6	7	12,5	14500
12,82	M16x1,5	88296002000147	1,50	102	31,7	48	18	16,3	33,6	8	14,5	16500

- P ●
- M ●
- K ●
- N ●
- S ●
- H ●
- O ●

→ v_c/f_z Page 78

1 When calculating the feedrate for circular milling it is important to know whether contour feed v_f or feed on the center path v_{fm} is used. Details on → Page 82+83.

MonoThread – Thread Milling Cutter with Chamfer Facet

▲ Profile corrected

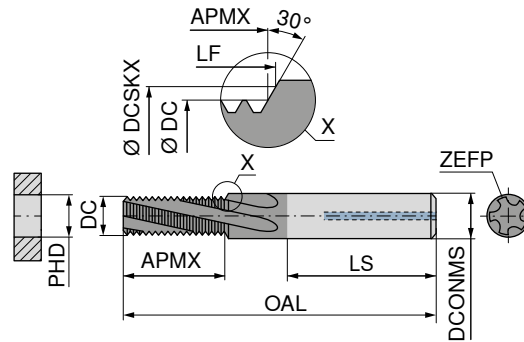
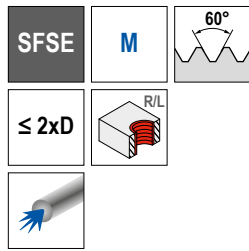

TiAIN



Solid carbide

50 811 ...

DC mm	Thread	TP mm	OAL mm	APMX mm	LS mm	DCONMS _{h6} mm	DCSKX mm	LF mm	ZEPF	PHD mm	
4,0	M5	0,80	62	11	36	8	5,3	11,16	3	4,2	050
4,7	M6	1,00	62	13	36	8	6,3	13,93	3	5,0	060
6,5	M8	1,25	74	18	40	10	8,3	18,62	3	6,8	080
8,0	M10	1,50	74	22	40	10			3	8,5	100 ¹⁾
10,0	M12	1,75	90	26	45	14	12,3	26,47	4	10,2	120
12,5	M16	2,00	100	35	48	16			4	14,0	160 ²⁾

- 1) Without chamfer
- 2) Chamfer section at the front of the tool



50 816 ...

DC mm	Thread	TP mm	OAL mm	APMX mm	LS mm	DCONMS _{h6} mm	DCSKX mm	LF mm	ZEPF	PHD mm	
6,5	M8x1	1,00	74	18	40	10	8,3	18,00	3	7,0	082
8,0	M10x1	1,00	74	22	40	10			3	9,0	102 ¹⁾
8,0	M10x1,25	1,25	74	22	40	10			3	8,8	103 ¹⁾
10,0	M12x1,25	1,25	90	26	45	14	12,3	26,61	4	10,8	123
10,0	M12x1,5	1,50	90	26	45	14	12,3	27,30	4	10,5	124
11,0	M14x1	1,00	100	31	48	16	14,3	32,70	4	13,0	142
11,0	M14x1,5	1,50	100	31	48	16	14,3	32,08	4	12,5	144
12,5	M16x1,5	1,50	100	35	48	16			4	14,5	164 ²⁾

P	●
M	●
K	●
N	●
S	●
H	●
O	●

- 1) Without chamfer
- 2) Chamfer section at the front of the tool

→ v_c/f_z Page 77

When calculating the feedrate for circular milling it is important to know whether contour feed v_f or feed on the center path v_{fm} is used. Details on → Page 82+83.

MonoThread – Thread Milling Cutter with Chamfer Facet

▲ Profile corrected

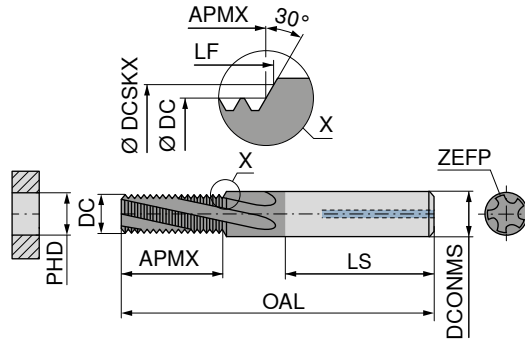
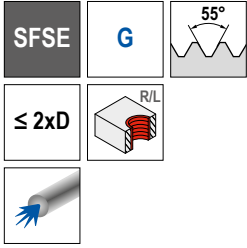

TiAIN



Solid carbide

50 818 ...

DC mm	Thread	TP mm	OAL mm	APMX mm	LS mm	DCONMS _{h6} mm	DCSKX mm	LF mm	ZEPF	PHD mm	
7,6	G 1/8-28	0,907	80	20	45	12	10,0	20,97	3	8,80	018
11,0	G 1/4-19	1,337	100	27	48	16	13,5	28,39	4	11,80	014
13,0	G 3/8-19	1,337	100	34	48	16			4	15,25	038 ¹⁾
16,0	G1/2-14	1,814	110	44	50	20			5	19,00	012 ¹⁾

1) Chamfer section at the front of the tool



50 819 ...

DC mm	Thread	TP mm	OAL mm	APMX mm	LS mm	DCONMS _{h6} mm	ZEPF	PHD mm	
5,8	NPT 1/16-27	0,941	62	10	36	8	3	6,15	116 ¹⁾
7,6	NPT 1/8-27	0,941	74	10	40	10	3	8,50	018 ¹⁾
10,1	NPT 1/4-18	1,411	90	15	45	14	3	11,10	014 ¹⁾
16,0	NPT 1/2-14	1,814	110	19	50	20	5	17,90	012 ¹⁾

P	●
M	●
K	●
N	●
S	●
H	●
O	●

1) Without chamfer

→ v_c/f_z Page 77

When calculating the feedrate for circular milling it is important to know whether contour feed v_f or feed on the center path v_{fm} is used. Details on → Page 82+83.

MonoThread – Thread milling cutter with chamfer facet

- ▲ Profile-corrected
- ▲ Hard machining to $\varnothing DC = 4 \text{ mm}$ possible
- ▲ Chamfer section at end of shank

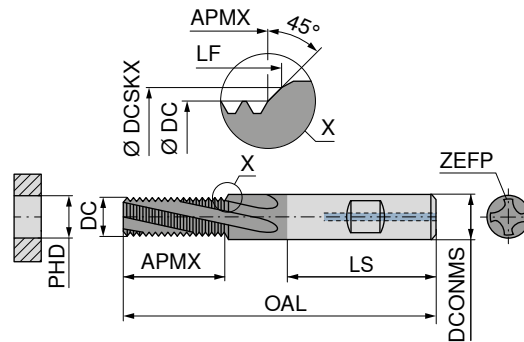
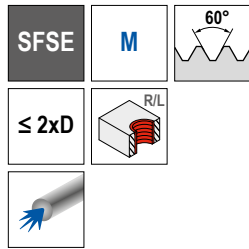

NEW

Ti500



Solid carbide

54 815 ...

DC mm	Thread	TP mm	OAL mm	LS mm	APMX mm	DCONMS _{h6} mm	DCSKX mm	LF mm	ZEFP mm	PHD mm	
4,00	M5	0,80	62	36	12,3	8	5,3	12,98	3	4,20	05000 ¹⁾
4,80	M6	1,00	62	36	14,4	8	6,3	15,18	3	5,00	06000 ¹⁾
6,50	M8	1,25	74	40	19,0	10	8,3	20,19	3	6,80	08000
7,95	M10	1,50	80	45	23,0	12	10,3	24,25	3	8,50	10000
9,90	M12	1,75	90	45	28,6	14	12,3	29,94	4	10,25	12000
11,60	M14	2,00	100	48	32,6	16	14,3	34,20	4	12,00	14000
11,95	M16	2,00	90	45	36,6	12			4	14,00	16000 ²⁾
13,95	M18	2,50	110	50	38,0	20	18,3	40,50	4	15,50	18000
15,95	M20	2,50	100	48	43,3	16			4	17,50	20000 ²⁾

- 1) Without Through Coolant
- 2) Chamfer section at the front of the tool



NEW

54 816 ...

DC mm	Thread	TP mm	OAL mm	APMX mm	LS mm	DCONMS _{h6} mm	DCSKX mm	LF mm	ZEFP mm	PHD mm	
6,0	M8x1	1,00	74	19,2	40	10	8,3	20,41	3	7,0	08000
8,0	M10x1	1,00	80	22,2	45	12	10,3	23,41	3	9,0	10000
8,0	M10x1,25	1,25	80	22,8	45	12	10,3	24,09	3	8,8	10100
9,9	M12x1	1,00	90	27,2	45	14	12,3	28,42	4	11,0	12000
9,9	M12x1,25	1,25	90	27,8	45	14	12,3	29,10	4	10,8	12100
9,9	M12x1,5	1,50	90	27,5	45	14	12,3	28,77	4	10,5	12200
11,6	M14x1	1,00	100	31,0	48	16	14,3	32,51	4	13,0	14000
11,6	M14x1,5	1,50	100	32,0	48	16	14,3	33,35	4	12,5	14100
12,0	M16x1,5	1,50	90	35,0	45	12			4	14,5	16000 ¹⁾
14,0	M18x1,5	1,50	110	39,0	50	20	18,3	41,30	4	16,5	18000
16,0	M20x1,5	1,50	100	44,0	48	16			4	18,5	20000 ¹⁾

P	•
M	•
K	•
N	•
S	•
H	•
O	•

- 1) Chamfer section at the front of the tool

→ v_c/f_z Page 77

When calculating the feedrate for circular milling it is important to know whether contour feed v_f or feed on the center path v_{fm} is used. Details on → Page 82+83.

MonoThread – Thread milling cutter with chamfer facet

- ▲ Profile-corrected
- ▲ Hard machining to $\varnothing DC = 4$ mm possible
- ▲ Chamfer section at end of shank

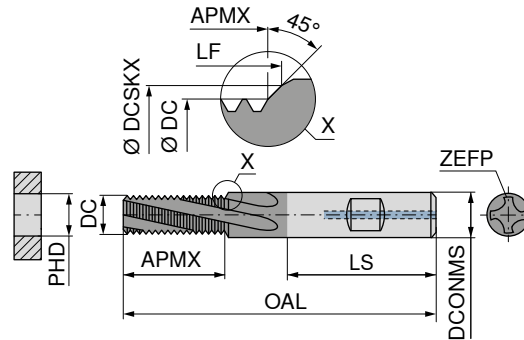
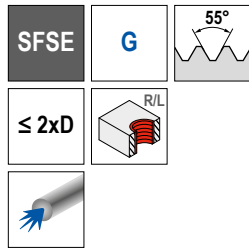

NEW

Ti500



Solid carbide

54 817 ...

DC mm	Thread	TP mm	OAL mm	APMX mm	LS mm	DCONMS _{h6} mm	DCSKX mm	LF mm	ZEFP mm	PHD mm	
6,00	G 1/16-28	0,907	74	16,5	40	10	8,02	17,54	3	6,80	11600
7,95	G 1/8-28	0,907	80	22,0	45	12	10,03	23,00	3	8,80	01800
9,90	G 1/4-19	1,337	100	28,0	48	16	13,46	29,98	4	11,80	01400
13,95	G 3/8-19	1,337	90	36,5	45	14			4	15,25	03800 ¹⁾
15,95	G 1/2-14	1,814	100	46,0	48	16			5	19,00	01200 ¹⁾
17,95	G 5/8-14	1,814	110	49,5	48	18			5	21,00	05800 ¹⁾

1) Chamfer section at the front of the tool



NEW

54 820 ...

DC mm	Thread	TP mm	OAL mm	APMX mm	LS mm	DCONMS _{h6} mm	ZEFP mm	PHD mm	
10,1	NPT 1/4-18	1,411	90	16,0	45	14	3	11,1	01400 ¹⁾
12,8	NPT 3/8-18	1,411	90	16,0	48	16	4	14,5	03800 ¹⁾
16,0	NPT 1/2-14	1,814	110	20,5	50	20	5	17,9	01200 ¹⁾
18,5	NPT 3/4-14	1,814	110	20,5	50	20	5	23,2	03400 ¹⁾

P	●
M	●
K	●
N	●
S	●
H	●
O	●

1) Chamfer section at the front of the tool

→ v_c/f_z Page 77

When calculating the feedrate for circular milling it is important to know whether contour feed v_f or feed on the center path v_{fm} is used. Details on → Page 82+83.

MonoThread – Thread milling cutter with chamfer facet

- ▲ Profile-corrected
- ▲ Hard machining to $\varnothing DC = 4 \text{ mm}$ possible
- ▲ Chamfer section at end of shank

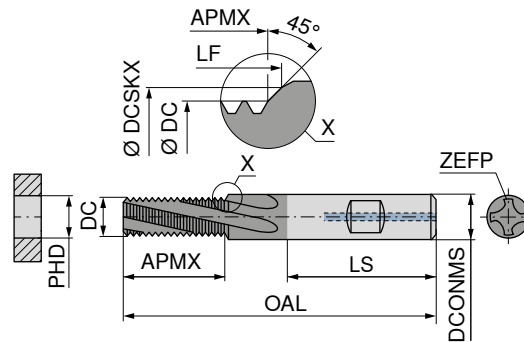
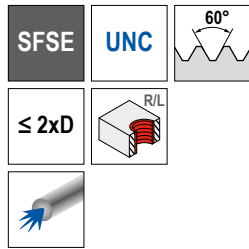

NEW

Ti500



Solid carbide

54 818 ...

DC mm	Thread	TP mm	OAL mm	APMX mm	LS mm	DCONMS _{h6} mm	DCSKX mm	LF mm	ZEFP	PHD mm	
4,80	UNC 1/4-20	1,270	62	14,4	36	8	6,65	15,43	3	5,1	01400 ¹⁾
5,95	UNC 5/16-18	1,411	74	20,2	40	10	8,24	21,44	3	6,6	51600
7,60	UNC 3/8-16	1,588	80	24,3	45	12	9,83	25,62	3	8,0	03800
7,95	UNC 7/16-14	1,814	90	24,0	45	14	11,41	25,86	3	9,4	71600
9,90	UNC 1/2-13	1,954	90	29,8	45	14	13,00	31,59	4	10,8	01200
11,80	UNC 9/16-12	2,117	100	34,5	48	16	14,59	36,19	4	12,2	91600
12,70	UNC 5/8-11	2,309	90	37,7	45	14			4	13,5	05800 ²⁾
15,20	UNC 3/4-10	2,540	110	41,2	50	20	19,35	43,63	5	16,5	03400

- 1) Without Through Coolant
- 2) Chamfer section at the front of the tool



NEW

54 819 ...

DC mm	Thread	TP mm	OAL mm	APMX mm	LS mm	DCONMS _{h6} mm	DCSKX mm	LF mm	ZEFP	PHD mm	
4,80	UNF 1/4-28	0,907	62	14,7	36	8	6,65	15,72	3	5,5	01400 ¹⁾
5,95	UNF 5/16-24	1,058	74	19,3	40	10	8,24	20,48	3	6,9	51600
8,00	UNF 3/8-24	1,058	80	22,5	45	12	9,83	23,54	3	8,5	03800
7,95	UNF 7/16-20	1,270	90	23,0	45	14	11,41	24,76	3	9,9	71600
9,90	UNF 1/2-20	1,270	90	28,0	45	14	13,00	29,75	4	11,5	01200
12,00	UNF 9/16-18	1,411	100	31,4	48	16	15,59	32,81	4	12,9	91600
13,50	UNF 5/8-18	1,411	90	35,7	45	14			4	14,5	05800 ²⁾
17,00	UNF 3/4-16	1,588	110	40,2	50	20	19,35	41,53	5	17,5	03400

P	●
M	●
K	●
N	●
S	●
H	●
O	●

- 1) Without Through Coolant
- 2) Chamfer section at the front of the tool

→ v_f/f_z Page 77

When calculating the feedrate for circular milling it is important to know whether contour feed v_f or feed on the center path v_{fm} is used. Details on → Page 82+83.

MonoThread – Circular shank thread milling cutter

▲ Available on request from M1

▲ Profile corrected

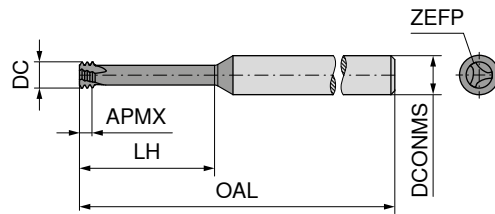

Ti600

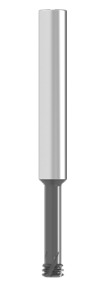

Solid carbide

50 802 ...

DC mm	Thread	TP mm	OAL mm	APMX mm	LH mm	DCONMS _{h6} mm	ZEFP	
1,53	M2	0,40	39	0,80	6,0	3	3	02000
2,37	M3	0,50	58	1,35	9,5	6	3	03000
3,10	M4	0,70	58	1,95	12,5	6	3	04000
3,80	M5	0,80	58	2,30	16,0	6	3	05000
4,65	M6	1,00	58	2,70	20,0	6	3	06000
6,00	M8	1,25	58	3,20	24,0	6	3	08000
7,80	M10	1,50	64	3,80	31,5	8	3	10000
9,00	M12	1,75	73	4,55	37,8	10	3	12000



50 803 ...

DC mm	Thread	TP mm	OAL mm	APMX mm	LH mm	DCONMS _{h6} mm	ZEFP	
1,53	M2	0,40	39	1,00	10,4	3	3	02000
2,40	M3	0,50	39	1,30	12,5	3	3	03000
3,10	M4	0,70	58	1,80	16,7	6	3	04000
4,00	M5	0,80	58	2,10	20,8	6	3	05000
4,80	M6	1,00	58	2,55	25,0	6	3	06000
6,40	M8	1,25	64	3,15	33,5	8	3	08000
8,00	M10	1,50	76	3,85	41,5	8	3	10000

P	●
M	●
K	●
N	●
S	●
H	●
O	●

→ v_c/f_z Page 78

1 When calculating the feedrate for circular milling it is important to know whether contour feed v_f or feed on the center path v_{fm} is used. Details on → Page 82+83.

MonoThread – Thread Milling Cutter

▲ Available on request: M30, M36, M42, M48, M56, M64

▲ Profile corrected

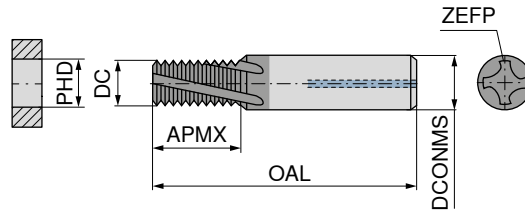
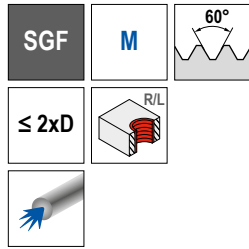

TiAlN



Solid carbide

50 825 ...

DC mm	Thread	TP mm	APMX mm	DCONMS _{h6} mm	OAL mm	ZEFP	PHD mm	
2,40	M3	0,50	6	4	42	3	2,5	030 ¹⁾
3,15	M4	0,70	8	6	55	3	3,3	040
4,00	M5	0,80	10	6	55	3	4,2	050
4,80	M6	1,00	12	6	55	3	5,0	060
6,00	M8	1,25	16	6	63	3	6,8	080
8,00	M10	1,50	20	8	70	3	8,5	100
9,90	M12	1,75	24	10	80	4	10,2	120
11,60	M14	2,00	28	12	90	4	12,0	140
12,00	M16	2,00	32	12	90	4	14,0	160
14,00	M18	2,50	36	14	90	4	15,5	180
14,00	M20	2,50	40	14	90	4	17,5	200
14,00	M22	2,50	44	14	95	4	19,5	220

1) Without Through Coolant



50 826 ...

DC mm	Thread	TP mm	APMX mm	DCONMS _{h6} mm	OAL mm	ZEFP	PHD mm	
3,35	M4x0,5	0,50	8	6	55	3	3,5	040
4,20	M5x0,5	0,50	10	6	55	3	4,5	050
5,00	M6x0,75	0,75	12	6	55	3	5,2	061
6,00	M8x0,75	0,75	16	6	63	3	7,2	081
6,00	M8x1	1,00	16	6	63	3	7,0	082
8,00	M10x1	1,00	20	8	70	3	9,0	102
10,00	M12x1	1,00	24	10	80	4	11,0	122
10,00	M12x1,5	1,50	24	10	80	4	10,5	124
10,00	M14x1,5	1,50	28	10	80	4	12,5	144
12,00	M16x1,5	1,50	32	12	90	4	14,5	164
14,00	M18x1,5	1,50	36	14	90	4	16,5	184
14,00	M20x1,5	1,50	40	14	90	4	18,5	204
14,00	M22x1,5	1,50	44	14	95	4	20,5	224
16,00	M24x1,5	1,50	36	16	90	5	22,5	244

P	•
M	•
K	•
N	•
S	•
H	•
O	•

→ v_c/f_z Page 77

When calculating the feedrate for circular milling it is important to know whether contour feed v_r or feed on the center path v_m is used. Details on → Page 82+83.

MonoThread – Thread Milling Cutter

▲ Profile corrected

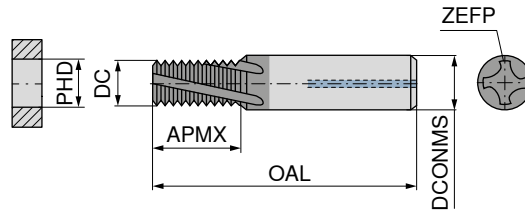
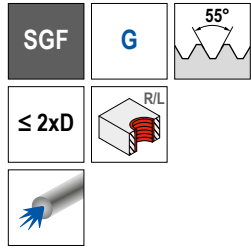

TiAlN



Solid carbide

50 827 ...

DC mm	Thread	TP mm	APMX mm	DCONMS _{h6} mm	OAL mm	ZEFP	PHD mm	
8	G 1/8-28	0,907	19,5	8	70	3	8,80	018
11	G 1/4-19	1,337	26,5	12	90	4	11,80	014
12	G 3/8-19	1,337	33,0	12	90	4	15,25	038
14	G 1/2-14	1,814	42,0	14	95	4	19,00	012
16	G 3/4-14	1,814	34,0	16	90	5	24,50	034
16	G 5/8-14	1,814	34,0	16	90	5	21,00	058
16	G 1-11	2,309	33,0	16	90	5	30,75	100

P	●
M	●
K	●
N	●
S	●
H	●
O	●

→ v_c/f_z Page 77

When calculating the feedrate for circular milling it is important to know whether contour feed v_f or feed on the center path v_{fm} is used. Details on → Page 82+83.

MonoThread – Thread milling cutter

- ▲ Profile corrected
- ▲ Hard machining to Ø DC = 4 mm possible

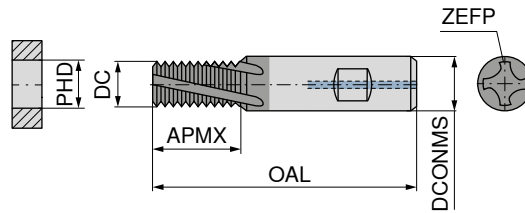
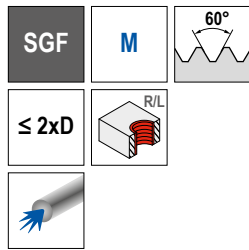

NEW
Ti500



Solid carbide
54 821 ...

DC mm	Thread	TP mm	APMX mm	DCONMS _{h6} mm	OAL mm	ZEFP	PHD mm	
2,40	M3	0,50	7,0	4	42	2	2,50	03000 ¹⁾
3,15	M4	0,70	10,0	6	55	3	3,30	04000 ²⁾
4,00	M5	0,80	12,2	6	55	3	4,20	05000 ²⁾
4,80	M6	1,00	14,3	6	55	3	5,00	06000 ²⁾
6,00	M8	1,25	19,0	6	60	3	6,75	08000
8,00	M10	1,50	23,0	8	70	3	8,50	10000
9,90	M12	1,75	28,6	10	75	4	10,25	12000
11,60	M14	2,00	32,6	12	85	4	12,00	14000
12,00	M16	2,00	36,6	12	85	4	14,00	16000
14,00	M18	2,50	43,3	14	90	4	15,50	18000
16,00	M20	2,50	43,3	16	90	4	17,50	20000

- 1) DIN 6535 HA Shank / Without Through Coolant
- 2) Without Through Coolant



NEW
54 822 ...

DC mm	Thread	TP mm	APMX mm	DCONMS _{h6} mm	OAL mm	ZEFP	PHD mm	
4,0	M 5x0,5	0,50	11,6	6	55	3	4,50	05000 ¹⁾
4,8	M 6x0,75	0,75	14,5	6	55	3	5,25	06000 ¹⁾
6,0	M 8x1	1,00	19,3	6	60	3	7,00	08000
8,0	M 10x1,25	1,25	21,6	8	70	3	8,75	10000
9,9	M 12x1	1,00	27,3	10	75	4	11,00	12000
9,9	M 12x1,25	1,25	27,9	10	75	4	10,75	12100
9,9	M 12x1,5	1,50	27,5	10	75	4	10,50	12200
11,6	M 14x1	1,00	31,3	12	85	4	13,00	14000
11,6	M 14x1,5	1,50	32,0	12	85	4	12,50	14100
12,0	M 16x1,5	1,50	35,0	12	85	4	14,50	16000
14,0	M 18x1,5	1,50	42,5	14	90	4	16,50	18000
16,0	M 20x1,5	1,50	42,5	16	90	4	18,50	20000

P	•
M	•
K	•
N	•
S	•
H	•
O	•

- 1) DIN 6535 HA Shank / Without Through Coolant

→ v_c/f_z Page 77

1 When calculating the feedrate for circular milling it is important to know whether contour feed v_f or feed on the center path v_{fm} is used. Details on → Page 82+83.

MonoThread – Thread milling cutter

▲ Profile corrected

▲ Hard machining to Ø DC = 4 mm possible

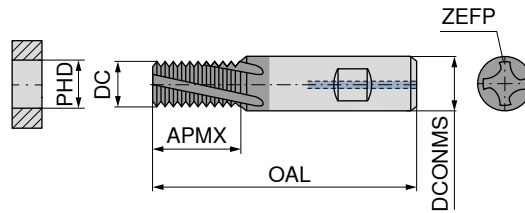
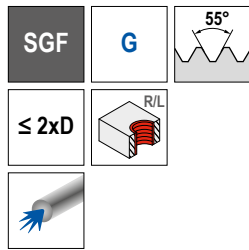

NEW
Ti500



Solid carbide

54 823 ...

DC mm	Thread	TP mm	APMX mm	DCONMS _{h6} mm	OAL mm	ZEFP	PHD mm	
8,0	G 1/8-28	0,907	22,0	8	70	3	8,80	01800
9,9	G 1/4-19	1,337	28,5	10	75	4	11,80	01400
14,0	G 3/8-19	1,337	42,0	14	90	4	15,25	03800
16,0	G 1/2-14	1,814	44,0	16	90	4	19,00	01200



NEW

54 824 ...

DC mm	Thread	TP mm	APMX mm	DCONMS _{h6} mm	OAL mm	ZEFP	PHD mm	
6,0	BSW 5/16 - 18	1,411	20,0	6	60	3	6,50	51600
6,0	BSW 3/8 - 16	1,588	21,0	6	60	3	7,90	03800
8,0	BSW 7/16 - 14	1,814	24,0	8	70	3	9,25	71600
8,0	BSW 1/2 - 12	2,117	24,0	8	70	3	10,50	01200
9,9	BSW 5/8 - 11	2,309	30,5	10	75	4	13,50	05800



NEW

54 825 ...

DC mm	Thread	TP mm	APMX mm	DCONMS _{h6} mm	OAL mm	ZEFP	PHD mm	
6,0	BSF 5/16 - 22	1,155	20,0	6	60	3	6,8	51600
6,0	BSF 3/8 - 20	1,270	19,4	6	60	3	8,3	03800
8,0	BSF 7/16 - 18	1,411	23,0	8	70	3	9,7	71600
8,0	BSF 1/2 - 16	1,588	24,2	8	70	3	11,1	01200
9,9	BSF 5/8 - 14	1,814	29,5	10	75	4	14,0	05800

P	•
M	•
K	•
N	•
S	•
H	•
O	•

→ v_c/f_z Page 77

When calculating the feedrate for circular milling it is important to know whether contour feed v_c or feed on the center path v_m is used. Details on → Page 82+83.

MonoThread – Thread milling cutter

▲ Profile corrected

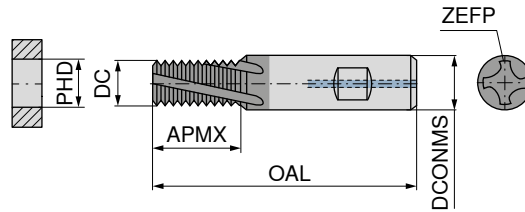
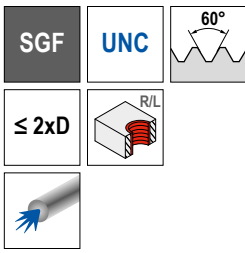

NEW
Ti500



Solid carbide

54 826 ...

DC mm	Thread	TP mm	APMX mm	DCONMS _{h6} mm	OAL mm	ZEFP mm	PHD mm
4,80	UNC 1/4-20	1,270	14,4	6	55	3	5,1
6,00	UNC 5/16-18	1,411	20,2	6	60	3	6,6
7,60	UNC 3/8-16	1,588	24,3	8	70	3	8,0
7,95	UNC 7/16-14	1,814	24,0	8	70	3	9,4
9,90	UNC 1/2-13	1,954	29,0	10	75	4	10,8

01400¹⁾
51600
03800
71600
01200

1) DIN 6535 HA Shank / Without Through Coolant



NEW

54 827 ...

DC mm	Thread	TP mm	APMX mm	DCONMS _{h6} mm	OAL mm	ZEFP mm	PHD mm
4,8	UNF 1/4-28	0,907	14,8	6	55	3	5,5
6,0	UNF 5/16-24	1,058	19,3	6	60	3	6,9
8,0	UNF 3/8-24	1,058	22,5	8	70	3	8,5
8,0	UNF 7/16-20	1,270	23,2	8	70	3	9,9
9,9	UNF 1/2-20	1,270	28,3	10	75	4	11,5

01400¹⁾
51600
03800
71600
01200

P	●
M	●
K	●
N	●
S	●
H	●
O	●

1) Without Through Coolant

→ v_c/f_z Page 77



When calculating the feedrate for circular milling it is important to know whether contour feed v_c or feed on the center path v_m is used. Details on → Page 82+83.

MonoThread – Thread milling cutter

▲ Intra-dimensional, pitch-dependent

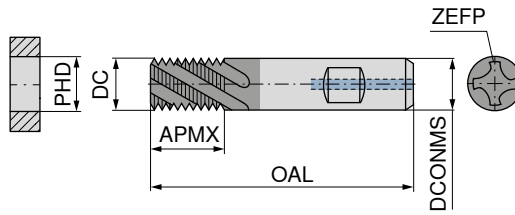
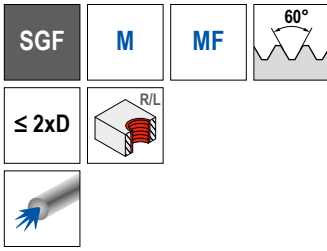

NEW
Ti500



Solid carbide

54 828 ...

DC mm	TP mm	APMX mm	DCONMS _{h6} mm	OAL mm	ZEFP mm	PHD mm	
8	0,50	12,0	8	70	3	10	00800
8	0,75	12,0	8	70	3	11	08000
10	1,00	16,0	10	75	4	14	10000
10	1,50	16,5	10	75	4	14	10100
12	1,00	20,0	12	85	4	16	12000
12	1,50	21,0	12	85	4	16	12100
12	2,00	20,0	12	85	4	18	12200
16	1,00	25,0	16	90	5	22	16000
16	1,50	25,5	16	90	5	22	16100
16	2,00	26,0	16	90	5	22	16200
16	3,00	27,0	16	90	5	24	16400

P	●
M	●
K	●
N	●
S	●
H	●
O	●

→ v_c/f_z Page 77

When calculating the feedrate for circular milling it is important to know whether contour feed v_t or feed on the center path v_{fm} is used. Details on → Page 82+83.

Material examples for cutting data tables

	Material sub-group	Index	Composition / Structure / Heat treatment	Tensile strength N/mm ² / HB / HRC	Material number	Material designation	Material number	Material designation
P	Unalloyed steel	P.1.1	< 0,15 % C Annealed	420 N/mm ² / 125 HB	1.0401	C15	1.1141	Ck15
		P.1.2	< 0,45 % C Annealed	640 N/mm ² / 190 HB	1.1191	C45E	1.0718	9SMnPb28
		P.1.3	< 0,45 % C Tempered	840 N/mm ² / 250 HB	1.1191	C45E	1.0535	C55
		P.1.4	< 0,75 % C Annealed	910 N/mm ² / 270 HB	1.1223	C60R	1.0535	C55
		P.1.5	< 0,75 % C Tempered	1010 N/mm ² / 300 HB	1.1223	C60R	1.0727	45S20
	Low-alloy steel	P.2.1	Annealed	610 N/mm ² / 180 HB	1.7131	16MnCr5	1.6587	17CrNiMo6
		P.2.2	Tempered	930 N/mm ² / 275 HB	1.7131	16MnCr5	1.6587	17CrNiMo6
		P.2.3	Tempered	1010 N/mm ² / 300 HB	1.7225	42CrMo4	1.3505	100Cr6
		P.2.4	Tempered	1200 N/mm ² / 375 HB	1.7225	42CrMo4	1.3505	100Cr6
	High-alloy steel and high-alloy tool steel	P.3.1	Annealed	680 N/mm ² / 200 HB	1.4021	X20Cr13	1.4034	X46Cr13
		P.3.2	Hardened and tempered	1100 N/mm ² / 300 HB	1.2343	X38CrMoV5-1	1.4034	X46Cr13
		P.3.3	Hardened and tempered	1300 N/mm ² / 400 HB	1.2343	X38CrMoV5-1	1.4034	X46Cr13
	Stainless steel	P.4.1	Ferritic / martensitic Annealed	680 N/mm ² / 200 HB	1.4016	X6Cr17	1.2316	X36CrMo16
		P.4.2	Martensitic Tempered	1010 N/mm ² / 300 HB	1.4112	X90CrMoV18	1.2316	X36CrMo16
M	Stainless steel	M.1.1	Austenitic / austenitic-ferritic Quenched	610 N/mm ² / 180 HB	1.4301	X5CrNi18-10	1.4571	X6CrNiMoTi17-12-2
		M.2.1	Austenitic Tempered	300 HB	1.4841	X15CrNiSi25-21	1.4539	X1NiCrMoCu25-20-5
		M.3.1	Austenitic / ferritic (Duplex)	780 N/mm ² / 230 HB	1.4462	X2CrNiMoN22-5-3	1.4501	X2CrNiMoCuWN25-7-4
K	Grey cast iron	K.1.1	Pearlitic / ferritic	350 N/mm ² / 180 HB	0.6010	GG-10	0.6025	GG-25
		K.1.2	Pearlitic (martensitic)	500 N/mm ² / 260 HB	0.6030	GG-30	0.6045	GG-45
	Spherulitic graphite cast iron	K.2.1	Ferritic	540 N/mm ² / 160 HB	0.7040	GGG-40	0.7060	GGG-60
		K.2.2	Pearlitic	845 N/mm ² / 250 HB	0.7070	GGG-70	0.7080	GGG-80
	Malleable iron	K.3.1	Ferritic	440 N/mm ² / 130 HB	0.8035	GTW-35-04	0.8045	GTW-45
		K.3.2	Pearlitic	780 N/mm ² / 230 HB	0.8165	GTS-65-02	0.8170	GTS-70-02
N	Aluminium wrought alloy	N.1.1	Non-hardenable	60 HB	3.0255	Al99,5	3.3315	AlMg1
		N.1.2	Hardenable Age-hardened	340 N/mm ² / 100 HB	3.1355	AlCuMg2	3.2315	AlMgSi1
	Cast aluminium alloy	N.2.1	≤ 12 % Si, non-hardenable	250 N/mm ² / 75 HB	3.2581	G-AlSi12	3.2163	G-AlSi9Cu3
		N.2.2	≤ 12 % Si, hardenable Age-hardened	300 N/mm ² / 90 HB	3.2134	G-AlSi5Cu1Mg	3.2373	G-AlSi9Mg
		N.2.3	> 12 % Si, non-hardenable	440 N/mm ² / 130 HB		G-AlSi17Cu4Mg		G-AlSi18CuNiMg
	Copper and copper alloys (bronze/brass)	N.3.1	Free-machining alloys, PB > 1 %	375 N/mm ² / 110 HB	2.0380	CuZn39Pb2 (Ms58)	2.0410	CuZn44Pb2
		N.3.2	CuZn, CuSnZn	300 N/mm ² / 90 HB	2.0331	CuZn15	2.4070	CuZn28Sn1As
		N.3.3	CuSn, lead-free copper and electrolytic copper	340 N/mm ² / 100 HB	2.0060	E-Cu57	2.0590	CuZn40Fe
	Magnesium alloys	N.4.1	Magnesium and magnesium alloys	70 HB	3.5612	MgAl6Zn	3.5312	MgAl3Zn
	S	Heat-resistant alloys	S.1.1	Fe - basis Annealed	680 N/mm ² / 200 HB	1.4864	X12NiCrSi 36-16	1.4865
S.1.2			Fe - basis Age-hardened	950 N/mm ² / 280 HB	1.4980	X6NiCrTiMoVB25-15-2	1.4876	X10NiCrAlTi32-20
S.2.1			Ni or Co basis Annealed	840 N/mm ² / 250 HB	2.4631	NiCr20TiAl (Nimonic80A)	3.4856	NiCr22Mo9Nb
S.2.2			Ni or Co basis Age-hardened	1180 N/mm ² / 350 HB	2.4668	NiCr19Nb5Mo3 (Inconel 718)	2.4955	NiFe25Cr20NbTi
S.2.3			Ni or Co basis Cast	1080 N/mm ² / 320 HB	2.4765	CoCr20W15Ni	1.3401	G-X120Mn12
Titanium alloys		S.3.1	Pure titanium	400 N/mm ²	3.7025	Ti99,8	3.7034	Ti99,7
		S.3.2	Alpha + beta alloys Age-hardened	1050 N/mm ² / 320 HB	3.7165	TiAl6V4	Ti-6246	Ti-6Al-2Sn-4Zr-6Mo
S.3.3	Beta alloys	1400 N/mm ² / 410 HB	Ti555.3	Ti-5Al-5V-5Mo-3Cr	R56410	Ti-10V-2Fe-3Al		
H	Hardened steel	H.1.1	Hardened and tempered	46–55 HRC				
		H.1.2	Hardened and tempered	56–60 HRC				
		H.1.3	Hardened and tempered	61–65 HRC				
		H.1.4	Hardened and tempered	66–70 HRC				
	Chilled iron	H.2.1	Cast	400 HB				
	Hardened cast iron	H.3.1	Hardened and tempered	55 HRC				
O	Non-metal materials	O.1.1	Plastics, duroplastic	≤ 150 N/mm ²				
		O.1.2	Plastics, thermoplastic	≤ 100 N/mm ²				
		O.2.1	Aramid fibre-reinforced	≤ 1000 N/mm ²				
		O.2.2	Glass/carbon-fibre reinforced	≤ 1000 N/mm ²				
		O.3.1	Graphite					

* Tensile strength

Cutting data standard values

Index	50 854 ..., 50 862 ..., 50 869 ..., 50 898 ...						50 840 ...				50 546 ..., 50 547...		
	BGF		Feed rate Drilling		Feed rate Thread milling		ZBGF	TiCN Solid carbide			HR	TiCN Solid carbide	
	Ti601	uncoated	≤ Ø 6	≤ Ø 12	≤ Ø 6	≤ Ø 12		Ø 3-5	Ø 6-10	Ø 12-16		< Ø 10	> Ø 10
	v _c (m/min)		f (mm/rev)		f _z (mm/tooth)		v _c (m/min)	f _z (mm/tooth)			v _c (m/min)	f _z (mm/tooth)	
P.1.1											100	0,025	0,05
P.1.2											100	0,025	0,05
P.1.3											100	0,025	0,05
P.1.4											80	0,015	0,035
P.1.5											80	0,015	0,035
P.2.1											100	0,025	0,05
P.2.2											80	0,015	0,035
P.2.3											80	0,015	0,035
P.2.4											80	0,015	0,035
P.3.1											100	0,025	0,05
P.3.2											80	0,015	0,035
P.3.3											80	0,02	0,04
P.4.1											80	0,02	0,04
P.4.2											80	0,02	0,04
M.1.1											80	0,02	0,04
M.2.1											80	0,02	0,04
M.3.1											80	0,02	0,04
K.1.1	80-120	50-80	0,10-0,15	0,15-0,22	0,02-0,05	0,05-0,10					120	0,03	0,09
K.1.2	80-120	50-80	0,10-0,15	0,15-0,22	0,02-0,05	0,05-0,10					120	0,03	0,09
K.2.1											100	0,02	0,05
K.2.2											100	0,02	0,05
K.3.1											100	0,02	0,05
K.3.2											100	0,02	0,05
N.1.1	100-400	100-400	0,10-0,25	0,25-0,30	0,03-0,06	0,06-0,10					350	0,05	0,1
N.1.2	100-400	100-400	0,10-0,25	0,25-0,30	0,03-0,06	0,06-0,10					350	0,05	0,1
N.2.1	100-300		0,10-0,25	0,25-0,30	0,03-0,06	0,06-0,10					350	0,05	0,1
N.2.2	100-400	100-400	0,10-0,25	0,25-0,30	0,03-0,06	0,06-0,10					250	0,05	0,1
N.2.3	100-160		0,10-0,25	0,25-0,30	0,03-0,06	0,06-0,10					250	0,05	0,1
N.3.1	100-300	100-300	0,10-0,30	0,25-0,30	0,03-0,06	0,06-0,10					350	0,05	0,1
N.3.2											350	0,05	0,1
N.3.3											350	0,05	0,1
N.4.1	100-400	100-400	0,10-0,25	0,25-0,30	0,03-0,06	0,06-0,10					350	0,05	0,1
S.1.1											40	0,02	0,05
S.1.2							80	0,01	0,03	0,03	20	0,02	0,05
S.2.1							60	0,01	0,02	0,02	20	0,02	0,05
S.2.2							60	0,01	0,02	0,02			
S.2.3							60	0,01	0,02	0,02			
S.3.1											100	0,02	0,05
S.3.2							80	0,01	0,03	0,03	80	0,02	0,05
S.3.3							60	0,01	0,02	0,02	80	0,02	0,05
H.1.1							80	0,01	0,03	0,03	40	0,008	0,017
H.1.2							60	0,01	0,02	0,02	25	0,005	0,012
H.1.3							40	0,005	0,01	0,01			
H.1.4													
H.2.1							100	0,03	0,04	0,04	60	0,02	0,04
H.3.1							60	0,01	0,02	0,02	25	0,005	0,012
O.1.1	60-100	60-100	0,10-0,25	0,25-0,30	0,03-0,06	0,06-0,10					120	0,04	0,1
O.1.2											120	0,04	0,1
O.2.1											80	0,04	0,1
O.2.2											80	0,04	0,1
O.3.1							180	0,04	0,05	0,08	130	0,04	0,1



The cutting data is strongly influenced by external conditions, such as the stability of the tool and workpiece clamping, material and type of machine. The specified values represent guideline cutting data that can be adjusted by approx. ±20% according to the usage conditions.

Cutting data standard values

Index	54 815 ..., 54 816 ..., 54 817 ..., 54 818 ..., 54 819 ..., 54 820 ... / 54 821 ..., 54 822 ..., 54 823 ..., 54 824 ..., 54 825 ..., 54 826 ..., 54 827 ..., 54 828 ...					50 811 ..., 50 816 ..., 50 818 ..., 50 819 ... / 50 825 ..., 50 826 ..., 50 827 ...				
	SFSE	SGF	Ti500 Solid carbide			SFSE	SGF	TiAlN Solid carbide		
			Ø 2,4 – 6,0	Ø 6,0 – 10,0	Ø 10,0 – 20,0			Ø 2,4 – 6,0	Ø 6,0 – 10,0	Ø 10,0 – 20,0
	v_c (m/min)		f_z (mm/tooth)			v_c (m/min)		f_z (mm/tooth)		
P.1.1	150		0,01–0,04	0,04–0,06	0,08–0,15	150		0,04	0,06	0,10
P.1.2	120		0,01–0,04	0,04–0,06	0,08–0,15	130		0,04	0,06	0,10
P.1.3	120		0,007–0,03	0,03–0,05	0,05–0,10	110		0,04	0,06	0,10
P.1.4	120		0,007–0,03	0,03–0,05	0,05–0,10	110		0,03	0,05	0,07
P.1.5	100		0,006–0,02	0,02–0,04	0,04–0,06	100		0,03	0,05	0,07
P.2.1	120		0,007–0,04	0,04–0,06	0,08–0,15	120		0,04	0,06	0,10
P.2.2	100		0,007–0,03	0,03–0,05	0,05–0,10	110		0,03	0,05	0,07
P.2.3	80		0,006–0,02	0,02–0,04	0,04–0,06	100		0,03	0,05	0,07
P.2.4	70		0,006–0,02	0,02–0,04	0,04–0,06	80		0,02	0,04	0,06
P.3.1	80		0,01–0,03	0,03–0,05	0,06–0,12	80		0,04	0,06	0,10
P.3.2	70		0,006–0,02	0,02–0,04	0,04–0,06	70		0,03	0,05	0,07
P.3.3	60		0,006–0,02	0,02–0,04	0,04–0,06	60		0,02	0,04	0,06
P.4.1	60		0,006–0,02	0,02–0,04	0,04–0,06	80		0,04	0,06	0,10
P.4.2	60		0,006–0,02	0,02–0,04	0,04–0,06	70		0,04	0,06	0,10
M.1.1	100		0,008–0,03	0,03–0,05	0,05–0,10	70		0,02	0,04	0,06
M.2.1	100		0,008–0,03	0,03–0,05	0,05–0,10	50		0,01	0,03	0,05
M.3.1	100		0,008–0,03	0,03–0,05	0,05–0,10	50		0,01	0,03	0,05
K.1.1	120		0,01–0,04	0,04–0,06	0,08–0,15	150		0,05	0,07	0,12
K.1.2	100		0,007–0,03	0,03–0,05	0,05–0,10	130		0,05	0,07	0,12
K.2.1	120		0,01–0,04	0,04–0,06	0,08–0,15	130		0,03	0,05	0,07
K.2.2	100		0,007–0,03	0,03–0,05	0,05–0,10	110		0,03	0,05	0,07
K.3.1	130		0,01–0,04	0,04–0,06	0,08–0,15	120		0,04	0,06	0,10
K.3.2	100		0,007–0,03	0,03–0,05	0,05–0,10	100		0,04	0,06	0,10
N.1.1	400		0,03–0,06	0,08–0,12	0,14–0,20	210		0,06	0,085	0,15
N.1.2	400		0,03–0,06	0,08–0,12	0,14–0,20	180		0,05	0,07	0,12
N.2.1	300		0,03–0,06	0,08–0,12	0,14–0,20	130		0,05	0,07	0,12
N.2.2	300		0,03–0,06	0,08–0,12	0,14–0,20	130		0,05	0,07	0,12
N.2.3	200		0,03–0,06	0,08–0,12	0,14–0,20	120		0,05	0,07	0,12
N.3.1	160		0,03–0,06	0,08–0,12	0,14–0,20	180		0,06	0,085	0,15
N.3.2	160		0,03–0,06	0,08–0,12	0,14–0,20	180		0,06	0,085	0,15
N.3.3	160		0,03–0,06	0,08–0,12	0,14–0,20	130		0,06	0,085	0,15
N.4.1	300		0,03–0,06	0,08–0,12	0,14–0,20	150		0,06	0,085	0,15
S.1.1	80		0,008–0,03	0,03–0,05	0,05–0,10	60		0,01	0,03	0,05
S.1.2	60		0,006–0,02	0,02–0,04	0,04–0,06					
S.2.1	40		0,006–0,02	0,02–0,04	0,04–0,06					
S.2.2	40		0,006–0,02	0,02–0,04	0,04–0,06					
S.2.3	40		0,006–0,02	0,02–0,04	0,04–0,06					
S.3.1	100		0,01–0,03	0,03–0,05	0,06–0,12	70		0,01	0,03	0,05
S.3.2	80		0,006–0,02	0,02–0,04	0,04–0,06					
S.3.3	60		0,006–0,02	0,02–0,04	0,04–0,06					
H.1.1	50		0,003–0,006	0,008–0,012	0,014–0,02					
H.1.2	40			0,006–0,01	0,01–0,015					
H.1.3										
H.1.4										
H.2.1	60			0,006–0,01	0,01–0,015					
H.3.1	40			0,006–0,01	0,01–0,015					
O.1.1	100		0,02–0,06	0,06–0,10	0,12–0,20	240		0,08	0,10	0,16
O.1.2	100		0,02–0,06	0,06–0,10	0,12–0,20	240		0,08	0,10	0,16
O.2.1	80		0,01–0,04	0,04–0,06	0,08–0,15	130		0,03	0,05	0,07
O.2.2	80		0,01–0,04	0,04–0,06	0,08–0,15	130		0,03	0,05	0,07
O.3.1	200		0,01–0,04	0,04–0,06	0,08–0,15	110		0,03	0,05	0,07



The cutting data is strongly influenced by external conditions, such as the stability of the tool and workpiece clamping, material and type of machine. The specified values represent guideline cutting data that can be adjusted by approx. $\pm 20\%$ according to the usage conditions.

Cutting data standard values

Index	50 802 ..., 50 803 ...					50 806 ..., 50 807 ...				50 804 ...	
	SGF	Ti600 Solid carbide				SFSE	AlCrN Solid carbide			SFSE Micro	Ti602 Solid carbide
		Ø 1-2	Ø 3-5	Ø 6-8	Ø 9-12		Ø 3-5	Ø 6-10	Ø 10-13		
	v_c (m/min)	f_z (mm/tooth)				v_c (m/min)	f_z (mm/tooth)			v_c (m/min)	f_z (mm/tooth)
P.1.1	110	0,05	0,09	0,14	0,16	100-140	0,015-0,03	0,04-0,06	0,06-0,10	20-40	0,01-0,02
P.1.2	110	0,05	0,09	0,14	0,16	100-120	0,015-0,03	0,04-0,06	0,06-0,10	20-40	0,01-0,02
P.1.3	110	0,05	0,09	0,14	0,16	80-100	0,015-0,02	0,03-0,05	0,03-0,07	20-40	0,01-0,02
P.1.4	110	0,05	0,09	0,14	0,16	80-100	0,015-0,02	0,02-0,04	0,03-0,05	20-40	0,01-0,02
P.1.5	110	0,05	0,09	0,14	0,16	80-100	0,015-0,02	0,02-0,03	0,03-0,04	20-40	0,01-0,02
P.2.1	80	0,04	0,08	0,12	0,14	100-120	0,015-0,03	0,04-0,06	0,06-0,10	20-40	0,01-0,02
P.2.2	80	0,04	0,08	0,12	0,14	80-100	0,015-0,03	0,02-0,05	0,03-0,07	20-40	0,01-0,02
P.2.3	80	0,04	0,08	0,12	0,14	80-100	0,015-0,02	0,02-0,03	0,03-0,04	20-40	0,01-0,02
P.2.4	80	0,04	0,08	0,12	0,14	80-100	0,015-0,02	0,02-0,03	0,03-0,04	20-40	0,01-0,02
P.3.1	60	0,04	0,08	0,12	0,14	100-120	0,015-0,03	0,04-0,06	0,06-0,10	20-40	0,01-0,02
P.3.2	60	0,04	0,08	0,12	0,14	80-100	0,015-0,02	0,02-0,03	0,03-0,04	20-40	0,01-0,02
P.3.3	60	0,04	0,08	0,12	0,14	80-100	0,015-0,02	0,02-0,03	0,03-0,04	20-40	0,01-0,02
P.4.1	60	0,04	0,08	0,12	0,14	60-80	0,015-0,03	0,04-0,06	0,06-0,10	20-40	0,01-0,02
P.4.2	80	0,04	0,08	0,12	0,14	60-80	0,015-0,03	0,04-0,06	0,06-0,10	20-40	0,01-0,02
M.1.1	80	0,04	0,05	0,07	0,10	60-80	0,015-0,03	0,04-0,06	0,06-0,10	20-30	0,01-0,02
M.2.1	80	0,04	0,05	0,07	0,10	60-80	0,015-0,03	0,04-0,06	0,06-0,10	20-30	0,01-0,02
M.3.1	80	0,04	0,05	0,07	0,10	60-80	0,015-0,03	0,04-0,06	0,06-0,10	20-30	0,01-0,02
K.1.1	50	0,05	0,09	0,14	0,16	100-120	0,02-0,04	0,04-0,08	0,06-0,10		
K.1.2	50	0,05	0,09	0,14	0,16	100-120	0,02-0,04	0,04-0,08	0,06-0,10		
K.2.1	50	0,05	0,09	0,14	0,16	100-120	0,02-0,04	0,04-0,08	0,06-0,10		
K.2.2	50	0,05	0,09	0,14	0,16	80-100	0,02-0,04	0,04-0,08	0,06-0,10		
K.3.1	50	0,05	0,09	0,14	0,16	80-100	0,02-0,04	0,04-0,08	0,06-0,08		
K.3.2	50	0,05	0,09	0,14	0,16	80-100	0,02-0,04	0,04-0,08	0,06-0,08		
N.1.1	130	0,05	0,09	0,14	0,16					30-50	0,02-0,03
N.1.2	130	0,05	0,09	0,14	0,16					30-50	0,02-0,03
N.2.1	120	0,04	0,05	0,07	0,10					30-50	0,02-0,03
N.2.2	100	0,04	0,05	0,07	0,10					30-50	0,02-0,03
N.2.3	100	0,04	0,05	0,07	0,10					30-50	0,02-0,03
N.3.1	130	0,05	0,09	0,14	0,16					30-50	0,02-0,03
N.3.2	130	0,05	0,09	0,14	0,16					30-50	0,02-0,03
N.3.3	130	0,05	0,09	0,14	0,16					30-50	0,02-0,03
N.4.1	110	0,04	0,05	0,07	0,10					30-50	0,02-0,03
S.1.1	30	0,03	0,04	0,06	0,07					20-30	0,01-0,02
S.1.2	30	0,03	0,04	0,06	0,07					20-30	0,01-0,02
S.2.1	30	0,03	0,04	0,06	0,07					20-30	0,01-0,02
S.2.2	30	0,03	0,04	0,06	0,07					20-30	0,01-0,015
S.2.3	30	0,03	0,04	0,06	0,07					20-30	0,01-0,015
S.3.1	30	0,03	0,04	0,06	0,07	60-80	0,015-0,02	0,02-0,03	0,03-0,04	20-30	0,01-0,02
S.3.2	30	0,03	0,04	0,06	0,07	60-80	0,01-0,015	0,015-0,02	0,025-0,035	20-30	0,01-0,015
S.3.3	30	0,03	0,04	0,06	0,07					20-30	0,01-0,015
H.1.1										20-30	0,01-0,015
H.1.2										20-30	0,01-0,015
H.1.3											
H.1.4											
H.2.1											
H.3.1											
O.1.1	150	0,06	0,12	0,19	0,19						
O.1.2	150	0,06	0,12	0,19	0,19						
O.2.1	150	0,06	0,12	0,19	0,19						
O.2.2	150	0,06	0,12	0,19	0,19						
O.3.1	100	0,05	0,09	0,14	0,14						



The cutting data is strongly influenced by external conditions, such as the stability of the tool and workpiece clamping, material and type of machine. The specified values represent guideline cutting data that can be adjusted by approx. $\pm 20\%$ according to the usage conditions.

Cutting data standard values

Index	50 890 ..., 50 891 ..., 50 892 ..., 50 896 ..., 50 897 ...		50 890 ..., 50 891 ..., 50 895 ...		50 863 ..., 50 864 ... / 50 885 ..., 50 887 ..., 50 888 ..., 50 889 ..., 50 894 ...			50 860 ..., 50 861 ..., 50 867 ..., 50 868 ... / 50 870 ...		
	MWN	uncoated Solid carbide	MWN	TiAlN Solid carbide	GZD	GZG	Ti500 Solid carbide		EAW	EWM
	v_c (m/min)	f_z (mm/tooth)	v_c (m/min)	f_z (mm/tooth)	v_c (m/min)	f_z (mm/tooth)		v_c (m/min)	f_z (mm/tooth)	
						$\emptyset 12-17$	$\emptyset 20-26$			
P.1.1	85	0,10	170	0,10	220	0,10-0,30	0,05-0,30	280	0,20	0,20
P.1.2	75	0,10	150	0,10	220	0,10-0,30	0,05-0,30	240	0,20	0,20
P.1.3	65	0,10	130	0,10	190	0,10-0,30	0,05-0,30	200	0,20	0,20
P.1.4	65	0,07	130	0,07	160	0,10-0,30	0,05-0,30	200	0,15	0,15
P.1.5	60	0,07	120	0,07	160	0,10-0,30	0,05-0,30	180	0,15	0,15
P.2.1	70	0,10	140	0,10	150	0,10-0,30	0,05-0,30	220	0,20	0,20
P.2.2	65	0,07	130	0,07	120	0,10-0,30	0,05-0,30	200	0,15	0,15
P.2.3	60	0,07	120	0,07	100	0,10-0,30	0,05-0,30	180	0,15	0,15
P.2.4	45	0,06	90	0,06	90	0,10-0,30	0,05-0,30	150	0,12	0,12
P.3.1	45	0,10	90	0,10	100	0,10-0,20	0,05-0,20	150	0,20	0,20
P.3.2	40	0,07	80	0,07	90	0,10-0,20	0,05-0,20	130	0,10	0,10
P.3.3	35	0,06	70	0,06	80	0,10-0,20	0,05-0,20	110	0,10	0,10
P.4.1	45	0,10	90	0,10	70	0,10-0,20	0,05-0,20	150	0,20	0,20
P.4.2	40	0,10	80	0,10	60	0,10-0,20	0,05-0,20	130	0,20	0,20
M.1.1	40	0,06	80	0,06	130	0,10-0,30	0,05-0,30	130	0,10	0,10
M.2.1	30	0,05	60	0,05	120	0,10-0,30	0,05-0,30	90	0,08	0,08
M.3.1	30	0,05	60	0,05	120	0,10-0,30	0,05-0,30	90	0,08	0,08
K.1.1	85	0,12	170	0,12	140	0,10-0,30	0,05-0,30	280	0,25	0,25
K.1.2	75	0,12	150	0,12	100	0,10-0,30	0,05-0,30	240	0,25	0,25
K.2.1	75	0,07	150	0,07	140	0,10-0,30	0,05-0,30	240	0,15	0,15
K.2.2	65	0,07	130	0,07	120	0,10-0,30	0,05-0,30	200	0,15	0,15
K.3.1	70	0,10	140	0,10	140	0,10-0,30	0,05-0,30	220	0,20	0,20
K.3.2	60	0,10	120	0,10	100	0,10-0,30	0,05-0,30	190	0,20	0,20
N.1.1	120	0,15	240	0,15	700	0,10-0,40	0,05-0,40	390	0,30	0,30
N.1.2	105	0,12	210	0,12	400	0,10-0,40	0,05-0,40	330	0,25	0,25
N.2.1	75	0,12	150	0,12	400	0,10-0,40	0,05-0,40	240	0,25	0,25
N.2.2	75	0,12	150	0,12	300	0,10-0,40	0,05-0,40	240	0,25	0,25
N.2.3	70	0,12	140	0,12	200	0,10-0,40	0,05-0,40	220	0,25	0,25
N.3.1	105	0,15	210	0,15	160	0,10-0,40	0,05-0,40	330	0,30	0,30
N.3.2	105	0,15	210	0,15	160	0,10-0,40	0,05-0,40	330	0,30	0,30
N.3.3	75	0,15	150	0,15	160	0,10-0,40	0,05-0,40	240	0,30	0,30
N.4.1	85	0,15	170	0,15	160	0,10-0,40	0,05-0,40	280	0,30	0,30
S.1.1								110	0,10	0,10
S.1.2								90	0,07	0,07
S.2.1								70	0,05	0,05
S.2.2								70	0,05	0,05
S.2.3								70	0,05	0,05
S.3.1								130	0,10	0,10
S.3.2								90	0,07	0,07
S.3.3								70	0,05	0,05
H.1.1								80	0,05	0,05
H.1.2								60	0,04	0,04
H.1.3										
H.1.4										
H.2.1								80	0,05	0,05
H.3.1								60	0,04	0,04
O.1.1	140	0,16								
O.1.2	140	0,16								
O.2.1	75	0,07								
O.2.2	75	0,07								
O.3.1			130	0,07				200	0,14	0,14



The cutting data is strongly influenced by external conditions, such as the stability of the tool and workpiece clamping, material and type of machine. The specified values represent guideline cutting data that can be adjusted by approx. $\pm 20\%$ according to the usage conditions.

Cutting data standard values

Index	50 872 ..., 50 875 ..., 50 876 ..., 50 879 ..., 50 880 ..., 50 881 ..., 50 882 ..., 50 883 ..., 50 884 ..., 50 886 ...		51 800 ...		50 851 ..., 50 852 ..., 50 853 ..., 50 855 ..., 50 857 ..., 50 858 ..., 50 859 ...	
	Polygon		Multipurpose milling		System 300	
	v_c (m/min)	f_z (mm/tooth)	f_z (mm/tooth)		v_c (m/min)	f_z (mm/tooth)
P.1.1	220	0,05–0,25	0,03–0,10		220	0,05–0,15
P.1.2	220	0,05–0,25	0,03–0,10		220	0,05–0,15
P.1.3	190	0,05–0,25	0,03–0,10		190	0,05–0,15
P.1.4	160	0,05–0,25	0,03–0,09		160	0,05–0,15
P.1.5	160	0,05–0,25	0,03–0,09		160	0,05–0,15
P.2.1	150	0,05–0,25	0,03–0,10		150	0,05–0,15
P.2.2	120	0,05–0,25	0,03–0,09		120	0,05–0,15
P.2.3	100	0,05–0,25	0,03–0,09		100	0,05–0,15
P.2.4	90	0,05–0,25	0,03–0,09		90	0,05–0,15
P.3.1	100	0,05–0,20	0,03–0,10		100	0,05–0,12
P.3.2	90	0,05–0,20	0,03–0,08		90	0,05–0,12
P.3.3	80	0,05–0,20	0,03–0,08		80	0,05–0,12
P.4.1	70	0,05–0,20	0,03–0,08		70	0,05–0,12
P.4.2	60	0,05–0,20	0,03–0,08		60	0,05–0,12
M.1.1	130	0,05–0,25	0,03–0,08		130	0,05–0,15
M.2.1	120	0,05–0,25	0,03–0,08		120	0,05–0,15
M.3.1	120	0,05–0,25	0,03–0,08		120	0,05–0,15
K.1.1	140	0,05–0,25	0,03–0,11		140	0,05–0,15
K.1.2	100	0,05–0,25	0,03–0,10		100	0,05–0,15
K.2.1	140	0,05–0,25	0,03–0,11		140	0,05–0,15
K.2.2	120	0,05–0,25	0,03–0,10		120	0,05–0,15
K.3.1	140	0,05–0,25	0,03–0,11		140	0,05–0,15
K.3.2	100	0,05–0,25	0,03–0,10		100	0,05–0,15
N.1.1	700	0,15–0,40	0,04–0,15		700	0,10–0,25
N.1.2	400	0,15–0,40	0,04–0,15		400	0,10–0,25
N.2.1	400	0,15–0,40	0,04–0,15		400	0,10–0,25
N.2.2	300	0,15–0,40	0,04–0,15		300	0,10–0,25
N.2.3	200	0,15–0,40	0,04–0,15		200	0,10–0,25
N.3.1	160	0,15–0,40	0,04–0,15		160	0,10–0,25
N.3.2	160	0,15–0,40	0,04–0,15		160	0,10–0,25
N.3.3	160	0,15–0,40	0,04–0,15		160	0,10–0,25
N.4.1	160	0,15–0,40	0,04–0,15		160	0,10–0,25
S.1.1	100	0,01–0,15	0,01–0,11		100	0,01–0,12
S.1.2	80	0,01–0,15	0,01–0,11		80	0,01–0,12
S.2.1	60	0,01–0,15	0,01–0,11		60	0,01–0,12
S.2.2	40	0,01–0,15	0,01–0,11		40	0,01–0,12
S.2.3	40	0,01–0,15	0,01–0,11		40	0,01–0,12
S.3.1	100	0,01–0,15	0,01–0,11		100	0,01–0,12
S.3.2	80	0,01–0,15	0,01–0,11		80	0,01–0,12
S.3.3	60	0,01–0,15	0,01–0,11		60	0,01–0,12
H.1.1	60	0,01–0,10	0,01–0,06		60	0,01–0,10
H.1.2	50	0,01–0,10	0,01–0,06		50	0,01–0,10
H.1.3	40	0,01–0,10	0,01–0,06		40	0,01–0,10
H.1.4	30	0,01–0,10	0,01–0,06		30	0,01–0,10
H.2.1	60	0,01–0,10	0,01–0,06		60	0,01–0,10
H.3.1	50	0,01–0,10	0,01–0,06		50	0,01–0,10
O.1.1	180	0,05–0,25	0,04–0,15		180	0,05–0,15
O.1.2	220	0,05–0,25	0,04–0,15		220	0,05–0,15
O.2.1	120	0,05–0,25	0,04–0,15		120	0,05–0,15
O.2.2	120	0,05–0,25	0,04–0,15		120	0,05–0,15
O.3.1	800	0,05–0,25	0,04–0,15		800	0,05–0,15



The cutting data is strongly influenced by external conditions, such as the stability of the tool and workpiece clamping, material and type of machine. The specified values represent guideline cutting data that can be adjusted by approx. $\pm 20\%$ according to the usage conditions.

Cutting data standard values

Index	53 006 ..., 53 007 ..., 53 008 ..., 53 009 ..., 53 010 ..., 53 011 ..., 53 012 ..., 53 013 ..., 53 015 ..., 53 016 ..., 53 017 ...				53 050 ..., 53 051 ..., 53 052 ..., 53 053 ...	
	Mini Mill	hole (Circular milling)	Thread (Thread milling)	Parting (multipurpose milling)	Micro Mill	
	v_c (m/min)	f_z (mm/tooth)			v_c (m/min)	f_z (mm/tooth)
P.1.1	120 (80–200)	0,03–0,10	0,05–0,20	0,015–0,05	70 (40–120)	0,01–0,05
P.1.2	110 (70–190)	0,03–0,10	0,05–0,20	0,015–0,05	60 (40–110)	0,01–0,05
P.1.3	90 (60–150)	0,03–0,10	0,05–0,20	0,015–0,05	50 (30–80)	0,01–0,05
P.1.4	90 (60–150)	0,03–0,08	0,05–0,18	0,015–0,04	50 (30–80)	0,01–0,05
P.1.5	70 (50–120)	0,03–0,08	0,05–0,18	0,015–0,04	40 (30–70)	0,01–0,05
P.2.1	90 (60–150)	0,03–0,10	0,05–0,20	0,015–0,05	50 (30–80)	0,01–0,05
P.2.2	70 (50–120)	0,03–0,08	0,05–0,18	0,015–0,04	40 (30–70)	0,01–0,05
P.2.3	60 (40–110)	0,02–0,07	0,05–0,16	0,015–0,035	40 (20–70)	0,01–0,05
P.2.4	60 (40–100)	0,03–0,07	0,05–0,16	0,015–0,035	30 (20–60)	0,01–0,04
P.3.1	60 (40–100)	0,03–0,10	0,05–0,20	0,015–0,05	30 (20–60)	0,01–0,05
P.3.2	50 (30–80)	0,02–0,07	0,05–0,16	0,015–0,035	30 (20–50)	0,01–0,04
P.3.3	30 (20–60)	0,02–0,07	0,05–0,16	0,015–0,035	20 (10–40)	0,005–0,03
P.4.1	80 (50–130)	0,03–0,08	0,05–0,18	0,015–0,04	40 (30–70)	0,01–0,05
P.4.2	60 (40–110)	0,02–0,07	0,05–0,16	0,015–0,035	40 (20–70)	0,01–0,05
M.1.1	90 (60–150)	0,02–0,07	0,05–0,16	0,015–0,035	50 (30–80)	0,01–0,03
M.2.1	60 (40–110)	0,02–0,07	0,05–0,16	0,015–0,035	40 (20–70)	0,01–0,03
M.3.1	50 (30–90)	0,02–0,07	0,05–0,16	0,015–0,035	30 (20–50)	0,01–0,03
K.1.1	110 (70–190)	0,03–0,10	0,05–0,20	0,015–0,05	60 (40–110)	0,008–0,06
K.1.2	80 (50–140)	0,03–0,10	0,05–0,20	0,015–0,05	50 (30–80)	0,008–0,06
K.2.1	70 (50–120)	0,03–0,10	0,05–0,20	0,015–0,05	40 (30–70)	0,008–0,06
K.2.2	60 (40–100)	0,03–0,10	0,05–0,20	0,015–0,05	30 (20–60)	0,008–0,06
K.3.1	110 (70–190)	0,03–0,10	0,05–0,20	0,015–0,05	60 (40–110)	0,008–0,06
K.3.2	90 (60–160)	0,03–0,10	0,05–0,20	0,015–0,05	50 (30–90)	0,008–0,06
N.1.1	230 (150–390)	0,04–0,15	0,06–0,25	0,02–0,075	150 (90–260)	0,01–0,06
N.1.2	220 (140–370)	0,04–0,15	0,06–0,25	0,02–0,075	140 (90–240)	0,01–0,06
N.2.1	190 (120–320)	0,04–0,15	0,06–0,25	0,02–0,075	120 (70–210)	0,01–0,06
N.2.2	160 (110–270)	0,04–0,15	0,06–0,25	0,02–0,075	100 (60–180)	0,01–0,06
N.2.3	90 (60–160)	0,04–0,15	0,06–0,25	0,02–0,075	60 (40–110)	0,01–0,06
N.3.1	170 (110–280)	0,04–0,15	0,06–0,25	0,02–0,075	110 (70–180)	0,01–0,06
N.3.2	140 (90–240)	0,04–0,15	0,06–0,25	0,02–0,075	80 (50–150)	0,01–0,06
N.3.3	120 (80–210)	0,04–0,15	0,06–0,25	0,02–0,075	80 (50–140)	0,01–0,06
N.4.1	170 (110–280)	0,04–0,15	0,06–0,25	0,02–0,075	70 (40–120)	0,01–0,06
S.1.1	60 (40–100)	0,04–0,15	0,06–0,25	0,02–0,075	30 (20–50)	0,01–0,06
S.1.2	40 (30–70)	0,04–0,15	0,06–0,25	0,02–0,075	20 (10–30)	0,01–0,06
S.2.1	60 (40–100)	0,04–0,15	0,06–0,25	0,02–0,075	30 (20–50)	0,01–0,06
S.2.2	50 (30–80)	0,04–0,15	0,06–0,25	0,02–0,075	20 (10–40)	0,01–0,06
S.2.3	30 (20–60)	0,04–0,15	0,06–0,25	0,02–0,075	20 (10–30)	0,01–0,06
S.3.1	60 (40–100)	0,04–0,15	0,06–0,25	0,02–0,075	20 (10–40)	0,01–0,06
S.3.2	30 (20–60)	0,04–0,15	0,06–0,25	0,02–0,075	20 (10–30)	0,01–0,06
S.3.3	30 (20–50)	0,04–0,15	0,06–0,25	0,02–0,075	10 (10–20)	0,01–0,06
H.1.1	50 (30–90)	0,02–0,06	0,04–0,14	0,02–0,037	20 (10–40)	0,005–0,03
H.1.2						
H.1.3						
H.1.4						
H.2.1						
H.3.1	40 (30–70)	0,02–0,10		0,015–0,05	20 (10–40)	0,005–0,03
O.1.1	180 (120–310)	0,04–0,15	0,06–0,25	0,02–0,037	80 (50–130)	0,02–0,09
O.1.2	170 (110–280)	0,04–0,15	0,06–0,25	0,02–0,037	70 (40–120)	0,02–0,09
O.2.1	140 (90–230)	0,04–0,15	0,06–0,25	0,02–0,037	50 (30–100)	0,02–0,09
O.2.2	100 (70–170)	0,04–0,15	0,06–0,25	0,02–0,037	40 (30–70)	0,02–0,09
O.3.1	140 (90–230)	0,005–0,05	0,06–0,25	0,0025–0,025	60 (40–110)	0,02–0,09



The cutting data depend extremely on the external conditions, the material and machine type. The indicated values are possible values which have to be increased or reduced, inside the bracket, according to the application conditions.

Milling Procedures

Climb milling

Characteristics:

- ① Tool rotation direction „right“
- ② Toolpath counter clockwise
- ③ Feed direction „outwards“

▶ Right hand thread

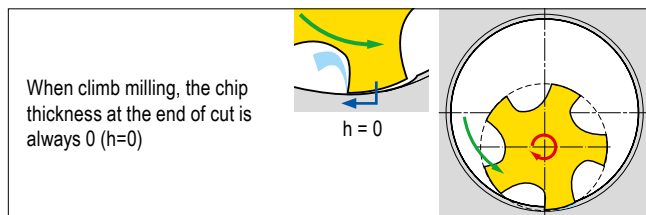
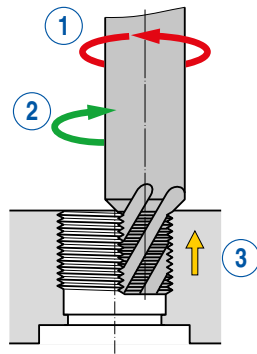

Conventional milling

Characteristics:

- ① Tool rotation direction „right“
- ② Toolpath clockwise
- ③ Feed direction „inwards“

▶ Right hand thread

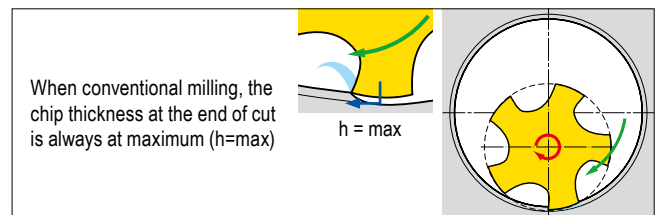
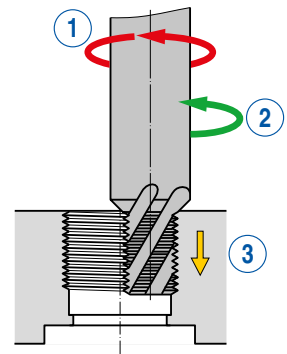

Feed rate calculation

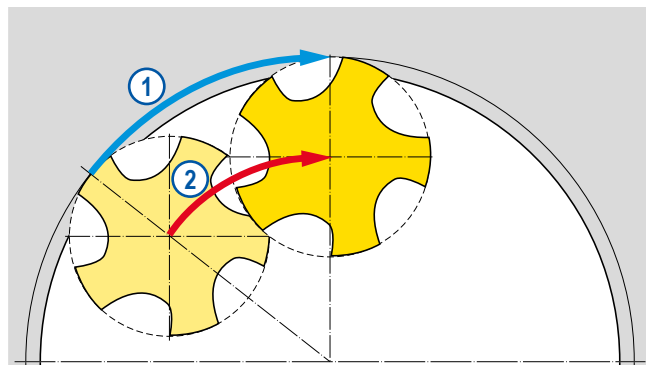

- D_w = Effective diameter in mm
- n = RPM in min^{-1}
- f_z = Feed per tooth in mm
- z = Number of cutting edges (radial)
- D = Nominal thread diameter = external profile diameter in mm
- D_m = Centre path diameter ($D - D_w$) in mm

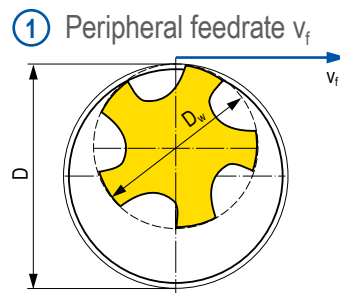

$$v_f = n \times f_z \times z \text{ mm/min.}$$

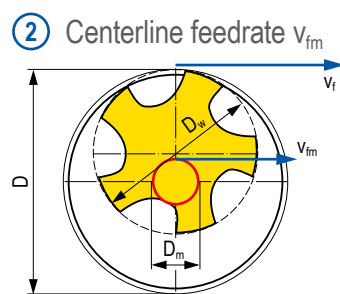

$$v_{fm} = \frac{v_f \times (D - D_w)}{D} \text{ mm/min.}$$

Tips for the User

① With thread milling there are two different programme possibilities with the feed motion of the tool.

On the one hand the machine controls the feed at the diameter of the tool, on the other hand the feed control is the tool center line. In order to ascertain which method the machine control uses, the following method should be employed:

- ▲ Enter the thread milling routine into the control.
- ▲ Enter a safety margin into the program, so that the tool runs in air.
- ▲ Run the program through and check the operating time.
- ▲ Compare the actual time with the calculated theoretical time.

If the time is longer than the calculated time the feed is controlling the tool center line.
If the time is shorter than the calculated time the feed is controlling the diameter of the tool.

Numeric calculation of cutting data for thread milling

$$n = \frac{v_c \times 1000}{d \times \pi}$$

$$v_c = \frac{d \times \pi \times n}{1000}$$

$$v_f = f_z \times z \times n$$

$$n = \frac{v_f}{f_z \times z}$$

$$f_z = \frac{v_f}{z \times n}$$

Milling – external contour

$$v_{fm} = \frac{v_f \times (D + d)}{D}$$

$$v_f = \frac{D \times v_{fm}}{(D + d)}$$

Milling – internal contour

$$v_{fm} = \frac{v_f \times (D - d)}{D}$$

$$v_f = \frac{D \times v_{fm}}{(D - d)}$$

Helical plunging

$$U_{arc} = 0,25 \times v_{fm}$$

Ramping in the arc

$$U_{arc} = v_{fm}$$

n rev./min. = rpm
 v_c m/min = Cutting speed
 d mm = Tool diameter
 D mm = Nominal thread-Ø
 v_f mm/min. = Feed rate at the diameter

v_{fm} mm/min. = Feed rate at the centre
 U_{arc} mm/min. = programmed ramping feed rate
 f_z mm = Feed per tooth
 z Piece = number of cutting edges of the cutter

Correction values for the internal thread milling

The milling radius correction which is entered into the machine control, can be calculated as follows:

half the cutter Ø – 0.05 x pitch P

Example:
 M30x3
 Cutter-Ø:
 20 mm

$$\frac{\varnothing 20}{2} - (0,05 \times 3) = \underline{9,85 \text{ mm}}$$

9,85 mm is the milling radius to be entered into the machine control

Coatings

AlCrN

- ▲ High-performance AlCrN multilayer coating
- ▲ max.application temperature: > 1100 °C

Ti 500

- ▲ TiAlN-coating
- ▲ Maximum application temperature: 500 °C

CWX 500

- ▲ Carbide, TiAlN-coated
- ▲ The universal carbide grade for almost all materials

Ti 600

- ▲ TiAlN multilayer coating
- ▲ Maximum application temperature: 650 °C

TiAlN

- ▲ TiAlN multilayer coating
- ▲ Maximum application temperature: 900 °C

Ti 601

- ▲ High-performance TiAlN multilayer coating
- ▲ Maximum application temperature: 900 °C

TiCN

- ▲ TiCN multilayer coating
- ▲ Maximum application temperature: 450 °C

Ti 602

- ▲ TiCN multilayer coating
- ▲ Maximum application temperature: 400 °C

TiN

- ▲ TiN coating
- ▲ Maximum application temperature: 450 °C