

New products for machining technicians

NEW Precision adjustment head hi.flex micro



▲ The continuation of the hi.flex system success story: the ultimate milestone in terms of precision, flexibility and user-friendliness is now getting a well-deserved "little brother". With a boring range of \varnothing 0.5 mm – 60 mm, it covers a very wide range of all upcoming spindle machining operations.

→ Page 19–21

NEW UltraMini/EcoCut boring bar adapter



▲ The new boring bar adapter can be used in all heads with a clamping diameter of 12 mm or 16 mm such as both sizes of the hi.flex micro precision adjustment head (and BluFlex 2). Using the UltraMini and EcoCut boring bars makes particular sense here since the adapter is also suitable for boring bars with a thro' coolant supply.

DCONMS 12 → Page 20
DCONMS 16 → Page 14

NEW MicroKom – Precision spindle set



▲ New: the MicroKom precision adjustment heads BluFlex 2, hi.flex and hi.flex micro are also available as a set

BluFlex 2	→ Page 12
hi.flex	→ Page 13
hi.flex micro	→ Page 19

NEW Interface adapter



▲ Total freedom in tool selection: thanks to the new interface adapters, ABS tools in STM base holders and STM tools in ABS base holders can be accommodated reliably and precisely.

→ Page 56

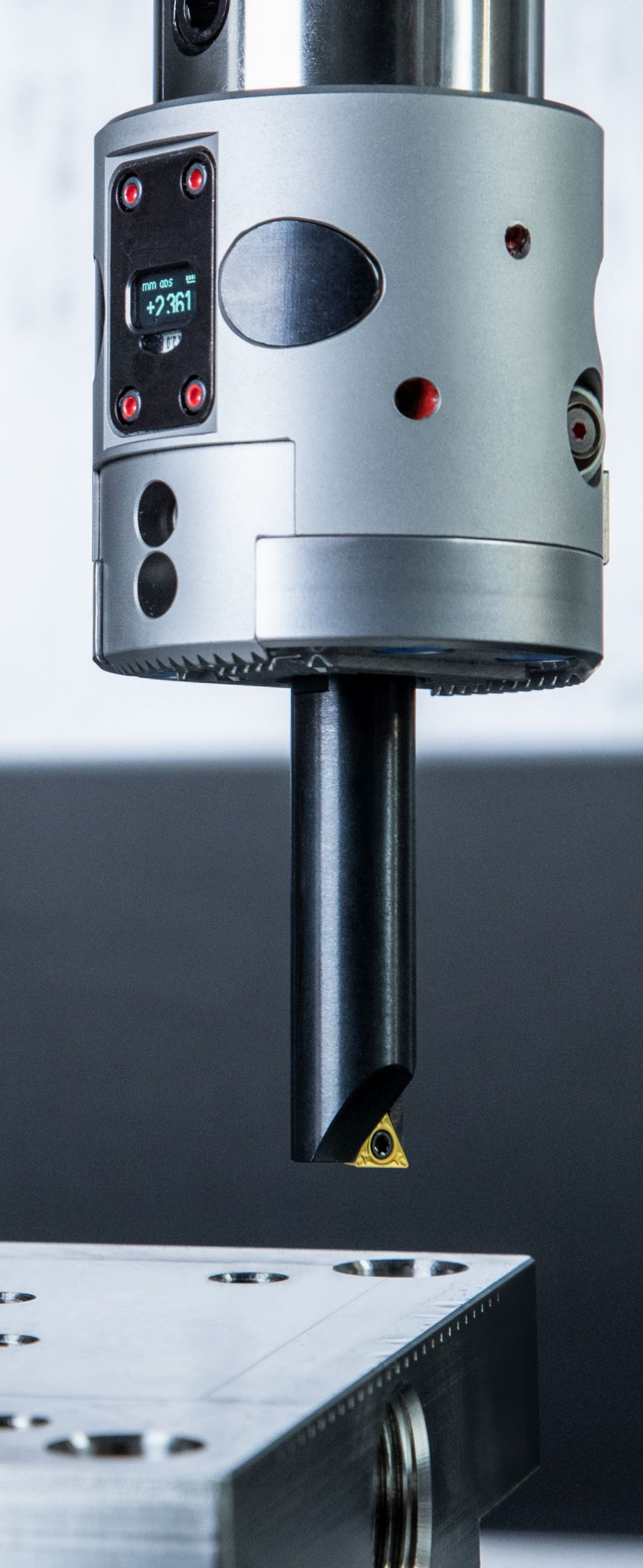

Solid drilling and bore machining

- 1 HSS drilling
- 2 Solid carbide drilling
- 3 Indexable insert drilling
- 4 Reaming and Countersinking

5 Spindle Tooling

Threading

- 6 Taps and thread formers
- 7 Circular and Thread Milling
- 8 Thread turning

Turning

- 9 Turning Tools
- 10 Multifunctional Tools – EcoCut and FreeTurn
- 11 Grooving Tools
- 12 Miniature turning tools

Milling

- 13 HSS Milling Cutters
- 14 Solid Carbide milling cutters
- 15 Milling tools with indexable inserts

Clamping technology

- 16 Adaptors and Accessories
- 17 Workpiece clamping

18 Material examples

Table of contents

Symbol explanation	4
Toolfinder	5–10
Contents Overview Accessories	11
Product programme	12–63
Cutting Data	64–71
Technical Information	
Fine boring tools	72+73
Counterboring tools	74
Insert	75
Notes on drilling technology	76
Problems / possible causes / solutions	77
Types of wear	78
Chip breakers	79
Grades / coatings	80+81

KOMET \ Performance

Premium quality tools for high performance.

The premium quality tools from the **KOMET Performance** product line have been designed for specific applications and are distinguished by their outstanding performance. If you make high demands on the performance of your production and want to achieve the very best results, we recommend the Premium tools in this product line.

Symbol explanation

F	Fine Machining
M	Medium Machining
R	Rough Machining

	Smooth cut
	Irregular cutting depth
	Interrupted cut

ABS KOMET ABS – modular coupling system for rotating and stationary tools

STM Modular SpinTools interface

ER 32 System-independent ER 32 interface

Coolant supply central
Steep taper Form AD



hi.flex / hi.flex micro

- ▲ The precision adjustment heads are characterised by their high precision, absolute reliability and enormous flexibility
- ▲ Available as analogue and digital variants (hi.flex: analogue + digital, hi.flex micro: analogue)
- ▲ Comprehensive accessories offer maximum flexibility (hi.flex: diameter range 0.5 – 365 mm, hi.flex micro: diameter range 0.5 – 60 mm)
- ▲ Higher RPMs can be reached thanks to the symmetrically balanced design (hi.flex: 17,500 rpm, hi.flex micro: 30,000 rpm)
- ▲ The sensitive adjustment for µ-precise width of cut
- ▲ With thro' coolant supply
- ▲ Universal ABS interface

Toolfinder

Machining	Diameter range per system in mm																System + quantity of counterboring or fine boring heads to cover the diameter range		Digital	Analogue	ABS Modular	STM Modular	ER 32 Modular	Monoblock	Through spindle	Case set	Page No.
	5	10	15	20	25	50	100	150	200	300	400	500	600	...	2200												
Finishing	0,5 – 365										BluFlex 2 1 Precision adjustment heads		✓		✓				✓ > Ø 65	✓	12						
	0,5 – 365										hi.flex 1 Precision adjustment heads		✓	✓	✓				✓ > Ø 60	✓	13						
	0,5 – 60					hi.flex micro 1 Precision adjustment heads			✓	✓						✓ > Ø 36	✓	19									
	24,8 – 206					M03 Speed 9 Precision adjustment heads			✓	✓						✓		22									
	29,5 – 199					15 FF precision adjustment heads			✓	✓						✓		24									
	0,3 – 19,1			2 Micro boring heads		✓	✓											26									
	14,7 – 24,1			3 Fine boring heads			✓								✓		28										
	3 – 320					1 Multi-Head – Fine boring head			✓		✓		✓	✓	✓ > Ø 63	✓	30										
	3 – 88,1			1 Single point boring head		✓	✓		✓	✓	✓				✓ > Ø 55	✓	32+33										
	23,9 – 154,1					6 Single point finish boring heads		✓	✓		✓				✓		38										
86 – 402					1 Single point finish boring head			✓		✓				✓	✓	42											
Roughing and Finishing	150 – 655										1 Console tool with baseplate		✓	✓				✓		62 402 ... 							
	650 – 2205													1 Console tool with slide		✓	✓				✓		62 405 ... 				
Roughing	24 – 215					TwinKom 8 Twin cutters			✓	✓						✓		44									
	23,5 – 87,5			5 Boring heads for roughing with 2 cutting edges			✓		✓						✓		47										

This article can be found in our online shop at cuttingtools.ceratizit.com

Overview – Fine boring systems

MicroKom

BluFlex 2 / hi.flex

Ø 0,5 – 365 mm

BluFlex 2



12

hi.flex



Analogue / digital
13

ABS

hi.flex micro

Ø 0,5 – 60 mm

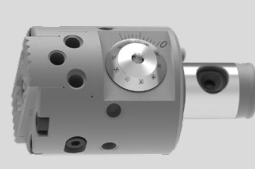

19

ABS

Ø 0,5 – 26 mm

- Ø 0,5 – 8 mm



UltraMini + EcoCut
→ Chapters 10 + 12



Adapter
14
- Ø 5,6 – 24 mm



Boring Bar
18



Adapter
17
- Ø 5,6 – 11 mm



Boring bar, vibration-optimised
17
- Ø 13 – 26 mm



Boring bar
17
- Ø 6 – 22 mm *



Steel boring bar
14
- Ø 7,9 – 23,9 mm



ABS32 boring bar
18

Ø 25 – 365 mm

- Ø 25 – 44 mm



Insert holder
15

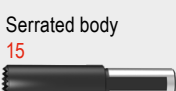

Serrated body
15
- Ø 44 – 63 mm



Insert holder
15



Filling piece
16
- Ø 63 – 93 mm



Insert holder
15



Filling piece
16
- Ø 90 – 365 mm



Insert holder
15



Bridge
16



Filling piece
16
- Ø 5 – 70 mm

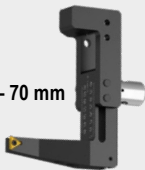

Spindle tool for external machining
16

Ø 0,5 – 25 mm

- Ø 0,5 – 8 mm



UltraMini + EcoCut
→ Chapters 10 + 12



Adapter
20
- Ø 8 – 13,8 mm



Boring Bar
20
- Ø 13,8 – 19,8 mm



Boring Bar
20
- Ø 19,8 – 25 mm



Boring Bar
20

Ø 25 – 60 mm

- Ø 25 – 44,8 mm



Insert holder
21

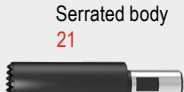

Serrated body
21
- Ø 44,8 – 60 mm



Insert holder
21

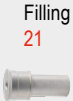

Filling piece
21



TO.X
58+59



WOHX *
57

* Used for steel boring bars
Ø 6 – 8 mm

necessary ———
optional - - - - -

SpinTools

Multi-Head boring and fine boring head

Ø 3 – 320 mm

HSK-A SK MAS BT STM

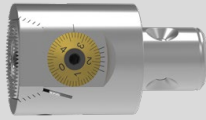

30

Single point finish boring head

Ø 3 – 88,1 mm

HSK-A SK MAS BT STM ER 32

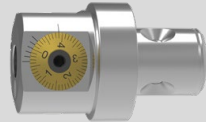

Analogue / digital
32+33

Micro Boring Head

Ø 0,3 – 19,1 mm

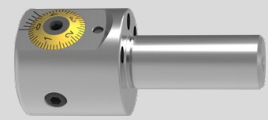

Analogue / digital
26

Ø 3 – 53,1 mm

Ø 3 – 12 mm
Boring steel 35

Ø 5,8 – 13,2 mm
Boring bar 36

Ø 8,75 – 40,1 mm
High-speed boring head + boring shank 37

Ø 9,75 – 53,1 mm
Steel boring bar 35

Reduction sleeve 36

Boring tool extension 36

Ø 29,75 – 320 mm

Ø 29,75 – 88,1 mm
Insert holder 35

Adjustable boring bar 35

Ø 86 – 320 mm
Counterweight 31

Bridge 31

Insert holder 31

Ø 3 – 53,1 mm

Ø 3 – 12 mm
Boring steel 35

Ø 5,8 – 13,2 mm
Boring bar 36

Ø 8,75 – 40,1 mm
High-speed boring head + boring shank 37

Ø 9,75 – 53,1 mm
Steel boring bar 35

Reduction sleeve 36

Boring tool extension 36

Ø 29,75 – 88,1 mm
Insert holder 35

Adjustable boring bar 35

Ø 0,3 – 7,1 mm
Solid carbide cutting insert 27

Adapter 27

Ø 5,2 – 8,1 mm
Solid carbide cutting insert 27









Ø 0,3 – 19,1 mm

Ø 6,9 – 19,1 mm
Solid carbide insert 27

Tool holder 27

CC.. 63

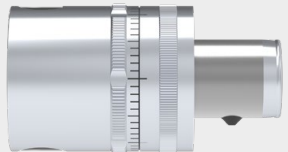
Overview – Fine boring tools

MicroKom	
M03 Speed	FF precision adjustment head
<p>Ø 24,8 – 206 mm</p> <p style="text-align: right;">ABS</p> <p>Precision adjustment heads 22</p> <p>Ø 24,8 – 39 mm</p>  <p>Insert holder 23</p>  <p>Precision adjustment heads 22</p> <p>Ø 38 – 103 mm</p>  <p>Insert holder 23</p>  <p>Interchangeable bridge 23</p> <p>Ø 38 – 206 mm</p>  <p>Insert holder 23</p>  <p>Precision adjustment heads 22</p> 	<p>Ø 29,5 – 199 mm</p> <p style="text-align: right;">ABS</p> <p>Precision adjustment heads 24</p>  <p>Precision turning insert 25</p> 



TO.X
58+59

necessary ———
optional - - - - -

SpinTools

Single point finish boring head

Ø 23,9 – 154,1 mm

STM

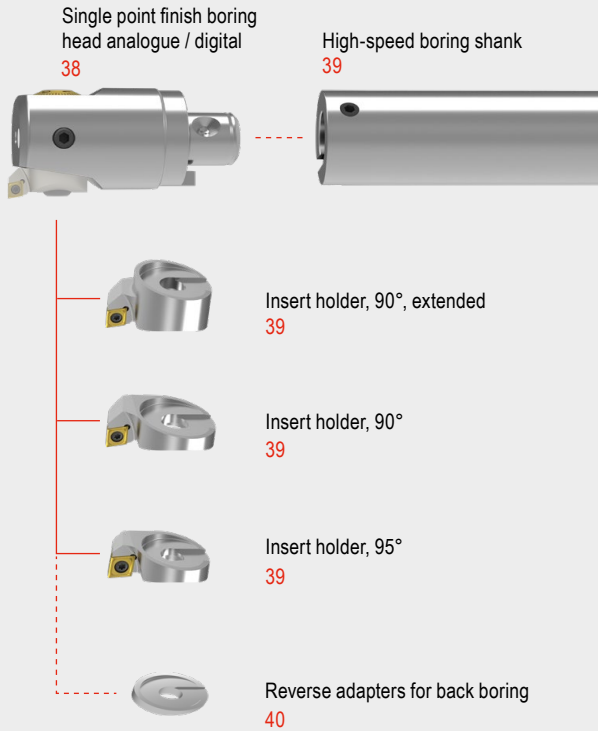

Fine boring head

Ø 14,7 – 24,1 mm

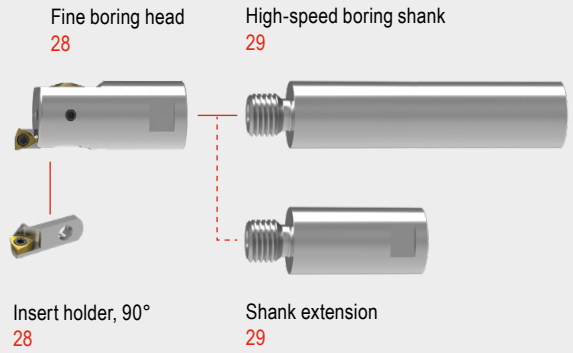

Ø 86 – 402 mm

STM

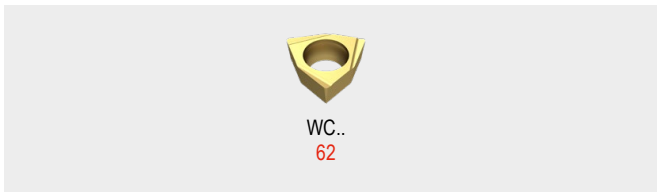
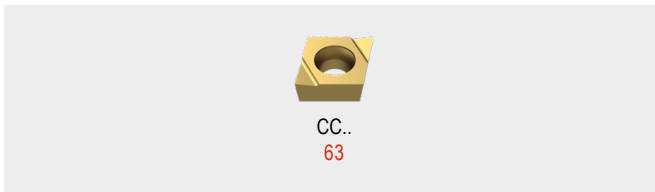
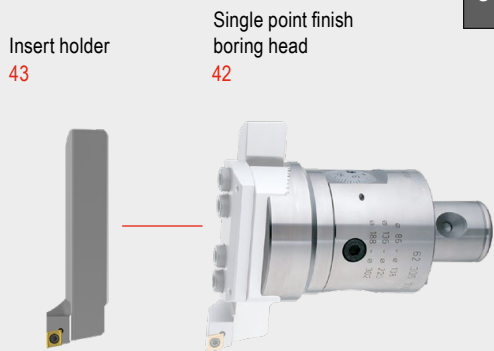

Overview – Counterboring and console tools

necessary ———
optional - - - - -

TwinKom

Twin cutter

Ø 24 – 215 mm

Tool holder 90°
radially adjustable
45



Tool holder 80°
radially adjustable
45



Basic tool holder,
radially + axially adjustable
46



Indexable insert 90°
46



Indexable insert 80°
46



ABS

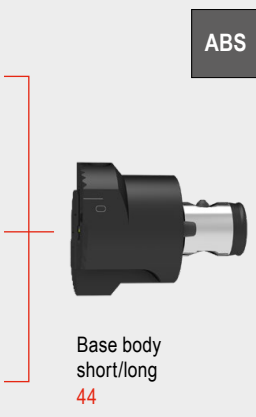

Base body
short/long
44

SpinTools

Twin rough boring head

Ø 23,5 – 87,5 mm

Pair of insert
holders,
Standard 90°
48



Pair of insert
holders,
Standard 70°
48



Pair of insert
holders,
Synchro 90°
49



STM

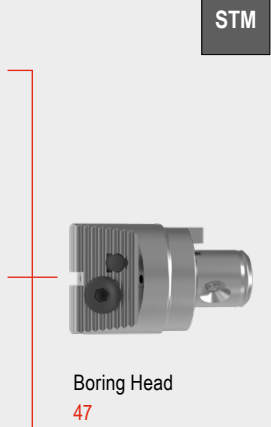

Boring Head
47



WO..
60+61



CC.. / CN..
63

SpinTools

Console tool



Ø 150 – 2205 mm

Rough boring block
90° (CC..) **62 412 ...**



Rough boring block
90° (CN..) **62 413 ...**



Rough boring block
70° (CN..) **62 414 ...**



Finish boring block
analogue / digital
62 410 ... / 62 409 ...



Insert holder
90° / 95°
62 318 ... / 62 320 ...



Ø 150 – 655 mm

Base plates
62 402 ...



Ø 650 – 2205 mm
Elongation console



Slide
62 406 ...

Counterweight
62 427 ...



Basis
62 405 ...



Base adapter
62 392 ...

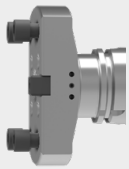

Ø 60 mm
DIN 6357



HSK-A

SK

MAS



BT

SK

MAS







BT

Overview of base adapters and accessories

		ISO 7388-1		ISO 7388-2		ISO 12164		ISO 26623-1
System		SK	SK-FC	MAS-BT	MAS-BT-FC	HSK-A	HSK-E	PSC
Base adapter		→ Clamping technology catalogue, Chapter 16, Adapters and accessories						
		16 42	16 44	16 85	16 106	16 137		16 166
		50		51		52		

5

Accessories

Extension		ABS	→ Clamping technology catalogue, Chapter 16, Adapters and accessories					
			16 183					
		STM	55					
Reduction		ABS	→ Clamping technology catalogue, Chapter 16, Adapters and accessories					
			16 187					
		STM	53					
Interface adapter	ABS → STM		ABS	56				
	STM → ABS		STM	56				

 Additional accessories available on request, such as balancing rings, axial grooving holders (UltraMini) and counterboring insert holders (0.4 mm offset) for SpinTools systems.

MicroKom – BluFlex 2 – precision adjustment head

- ▲ Via the free app (Android/iOS), an extended display can be transferred to a standard smartphone (62 840 16097)
- ▲ For MicroKom boring bars with Ø 16 or with ABS 32, MicroKom bridges, and serrated body
- ▲ With thro' coolant supply
- ▲ LSCX = Recess depth of boring bar

Scope of supply:

incl. Battery

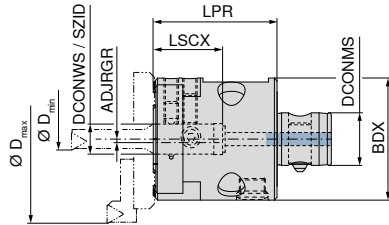

without Bluetooth with Bluetooth

62 820 ... **62 840 ...**

D _{min} - D _{max} mm	KOMET no.	Adapter	DCONWS mm	SZID	DCONMS mm	BDX mm	LPR mm	LSCX mm	ADJRGR mm	WT kg		
0,5 - 365	M04 30100	ABS 50	16	ABS 32	28	65	71	38	-0,2 - 2,3	1,45		16097
0,5 - 365	M04 30000	ABS 50	16	ABS 32	28	65	71	38	-0,2 - 2,3	1,45		16097

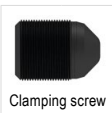

Clamping screw



Clamping screw



Clamping screw



Clamping sleeve

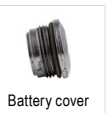

Battery cover

62 950 ... **62 950 ...** **62 950 ...** **62 950 ...** **62 950 ...**

Spare parts for Article no.

62 820 16097	M8x1x12/SW4	13989	M8x1x20/SW4	13700	M5x14/SW4	18600	18500	18400
62 840 16097	M8x1x12/SW4	13989	M8x1x20/SW4	13700	M5x14/SW4	18600	18500	18400

A detailed operating manual is available for download in the online shop next to the product.

Suitable ABS adapters can be found in → **Catalogue – Clamping technology, Chapter 16, Adaptors and Accessories.**

A detailed system overview you can find on → **Page 6.**

MicroKom – Precision spindle set BluFlex 2

Scope of supply:

- ▲ 1 plastic case
- ▲ 1 precision adjustment head
- ▲ 5 boring bars
 - 62 850 00600 Ø 6 mm
 - 62 850 01000 Ø 10 mm
 - 62 850 01400 Ø 14 mm
 - 62 850 01800 Ø 18 mm
 - 62 850 02200 Ø 22 mm
- ▲ 2 insert holders
 - 62 863 04400 Ø 25 – Ø 44 mm
 - 62 863 12500 Ø 44 – Ø 63 mm (– Ø 125 mm)
- ▲ 1 bridge
 - 62 860 12500 Ø 90 – Ø 125 mm
- ▲ 1 serrated body
 - 62 861 06300 Ø 25 – Ø 63 mm
- ▲ 1 filling piece
 - 62 862 09300 Ø 16x35 mm
- ▲ 10 indexable inserts
 - 2 pieces 62 600 00102 – WOHX02T001EL-G12 BK8440
 - 4 pieces 62 601 90206 – TOGX06T102EN-14 BK60
 - 4 pieces 62 601 70409 – TOGX090204EN-14 BK60
- ▲ 5 cylindrical screws
 - 62 950 00000 M5x16 mm
- ▲ 5 screwdrivers
 - 5IP, 6IP, 8IP, SW3, SW4

NEW

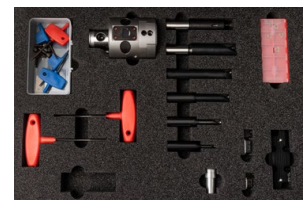

without Bluetooth with Bluetooth

62 820 ... **62 840 ...**

D _{min} - D _{max} mm		
6 - 125		
	99997	99997

MicroKom – hi.flex – precision adjustment head

- ▲ For MicroKom boring bars with Ø 16 mm or ABS 32, MicroKom bridges and serrated bodies
- ▲ With thro' coolant supply
- ▲ LSCX = Recess depth of boring bar
- ▲ hi.flex digital: please order the digital stick separately

ABS

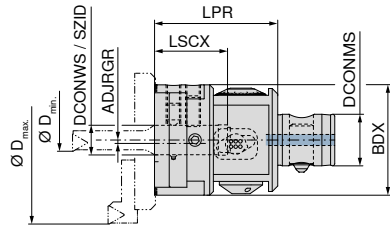

D _{min} - D _{max} mm	KOMET no.	Adapter	DCONWS mm	SZID	DCONMS mm	BDX mm	LPR mm	LSCX mm	ADJRGR mm	WT kg	Analogue	Digital
											62 800 ...	62 800 ...
0,5 - 365	M05 01000	ABS 50	16	ABS 32	28	60	67	39,7	-0,25 - 5	1,23	16097	
0,5 - 365	M04 10040	ABS 50	16	ABS 32	28	60	67	39,7	-0,25 - 5	1,23		16197

Spare parts for Article no.	62 800 16097		62 800 16197	
	62 800 16097	M8x8 - SW4	14700	M8x1x12/SW4
62 800 16197	M8x8 - SW4	14700	M8x1x12/SW4	13989

- A detailed operating manual is available for download in the online shop next to the product.
- Suitable ABS adapters can be found in → **Catalogue – Clamping technology, Chapter 16, Adaptors and Accessories.**
- A detailed system overview you can find on → **Page 6.**
- SpinTools – you can find the digital stick on → **Page 14.**

MicroKom – Precision spindle set hi.flex

Scope of supply:

- ▲ 1 plastic case
- ▲ 1 precision adjustment head
- ▲ 5 boring bars
 - 62 850 00600 Ø 6 mm
 - 62 850 01000 Ø 10 mm
 - 62 850 01400 Ø 14 mm
 - 62 850 01800 Ø 18 mm
 - 62 850 02200 Ø 22 mm
- ▲ 2 insert holders
 - 62 863 04400 Ø 25 – Ø 44 mm
 - 62 863 12500 Ø 44 – Ø 63 mm (– Ø 125 mm)
- ▲ 1 bridge
 - 62 860 12500 Ø 90 – Ø 125 mm
- ▲ 1 serrated body
 - 62 861 06300 Ø 25 – Ø 63 mm
- ▲ 1 filling piece
 - 62 862 09300 Ø 16x35 mm
- ▲ 10 indexable inserts
 - 2 pieces 62 600 00102 – WOHX02T001EL-G12 BK8440
 - 4 pieces 62 601 90206 – TOGX06T102EN-14 BK60
 - 4 pieces 62 601 70409 – TOGX090204EN-14 BK60
- ▲ 5 cylindrical screws
 - 62 950 00000 M5x16 mm
- ▲ 5 screwdrivers
 - 5IP, 6IP, 8IP, SW3, SW4

NEW



D _{min} - D _{max} mm	Analogue	Digital
	6 - 125	62 800 ... 99997

MicroKom – UltraMini / EcoCut boring bar adapter

- ▲ for hi.flex and BluFlex 2
- ▲ 4 clamping flats (offset by 90°) on Ø DCONMS
- ▲ with thro' coolant supply

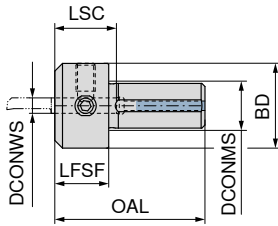

NEW

62 851 ...

DCONWS mm	KOMET no.	OAL mm	BD mm	LFSF mm	LSC mm	DCONMS mm	
4	M05 90950	39	22	14	18	16	16499
5	M05 90960	39	22	14	18	16	16599
6	M05 90970	39	22	14	18	16	16699
7	M05 90980	39	25	14	18	16	16799
8	M05 90990	39	25	14	18	16	16899

70 950 ...

Spare parts

DCONWS		
4 - 5		867
6 - 8		123



MicroKom – Steel boring bar for hi.flex, BluFlex 2

- ▲ with thro' coolant

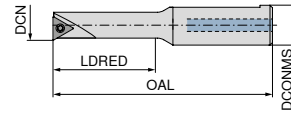

62 850 ...

DCN mm	KOMET no.	OAL mm	LDRED mm	DCONMS mm	Insert	
6	B05 20100	71,7	21,0	16	WO.. 02T0	00600
8	B05 20120	77,4	28,0	16	TO.. 06T1	00800
10	B05 20140	81,8	34,0	16	TO.. 0902	01000
12	B05 20160	88,2	42,0	16	TO.. 0902	01200
14	B05 20180	94,4	50,0	16	TO.. 0902	01400
18	B05 20220	100,0	60,0	16	TO.. 0902	01800
22	B05 20260	108,0	68,5	16	TO.. 1403	02200



62 950 ...

Spare parts

Insert	
WO.. 02T0	11800
TO.. 06T1	12800
TO.. 0902	12000
TO.. 1403	12600

i Suitable UltraMini / EcoCut tools can be found in → **Chapters 10 and 12.**

i Suitable inserts can be found on → **Page 57–59.**

SpinTools – Digital Stick

- ▲ suitable for all SpinTools digital heads as well as for hi.flex Digital
- ▲ revised software for even more precise adjustment

Scope of supply:
incl. AAA Battery



62 309 ...

00100

i A detailed operating manual is available for download in the online shop next to the product.

MicroKom – Serrated body for hi.flex, BluFlex 2

▲ with thro' coolant

Scope of supply:
without insert holder

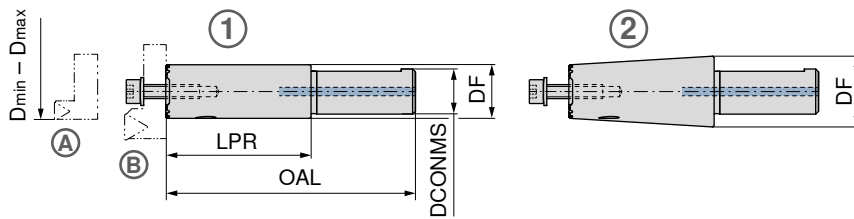

62 861 ...

D _{min} - D _{max} mm	KOMET no.	DCONMS mm	OAL mm	LPR mm	DF mm	Fig.
25 - 63	M05 90100	16	89,12	52,12	19	1
25 - 63	M05 90110	16	128,39	91,93	24	2

06300
16300

5

Spare parts
DCONMS
16



Cylindrical screw



Disk spring

62 950 ...

62 950 ...

M5x16

00000 10x5,2x0,3

19100

MicroKom – Insert holder for hi.flex, BluFlex 2

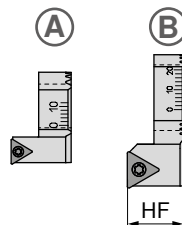

62 863 ...

DCN mm	DCX mm	KOMET no.	HF mm	Insert	Fig.
25	44	M05 20101	13,5	TO.. 06T1	A
44	63	M05 20151	13,5	TO.. 0902	B

04400
12500



TORX® Screws

62 950 ...

Spare parts
Insert
TO.. 06T1
TO.. 0902

M2x4,9/IP6

09700

M2,6x6,2 - 08IP

09900

Suitable inserts can be found on → Page 58+59.

MicroKom – Bridge for hi.flex, BluFlex 2

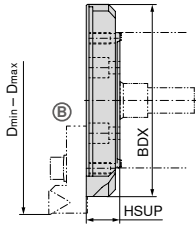

62 860 ...

D _{min} - D _{max} mm	KOMET no.	BDX mm	HSUP mm	WT kg	
90 - 125	M05 80101	85	14,89	0,147	12500
120 - 155	M05 80200	115	16,89	0,107	15500
150 - 185	M05 80300	145	18,89	0,152	18500
180 - 215	M05 80400	175	21,89	0,229	21500
210 - 245	M05 80500	205	25,00	0,309	24500
240 - 275	M05 80510	235	25,00	0,349	27500
270 - 305	M05 80520	265	25,00	0,394	30500
300 - 335	M05 80530	295	25,00	0,435	33500
330 - 365	M05 80540	325	25,00	0,478	36500



Cylindrical screw

62 950 ...

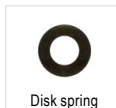

Disk spring

62 950 ...

Spare parts BDX

85 - 325

00000

19100

MicroKom – Spindle tool for external machining

▲ for hi.flex and BluFlex 2

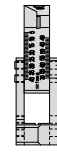
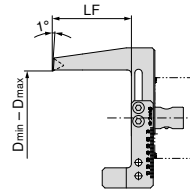

62 866 ...

D _{min} - D _{max} mm	KOMET no.	LF mm	Adapter	WT kg	Insert	
5 - 70	M05 90300	58	ABS 32	0,377	TO.X 0902..	07000



Cylindrical screw

62 950 ...



TORX® Screws

62 950 ...

Spare parts

Insert

TO.X 0902..

26800

12000



Suitable inserts can be found on → [Page 58+59](#).



A detailed operating manual is available for download in the online shop next to the product.

MicroKom – Filling piece for hi.flex, BluFlex 2

▲ For targeted redirecting of the thro' coolant to the cutting edge when using bridges or insert holders with diameters from 63 mm

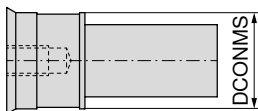

62 862 ...

DCONMS mm	KOMET no.	
16	M05 90501	09300

MicroKom – Adapter

▲ for 62 852 ..., 62 853 ..., 62 856 ... (essential for using the boring bar)

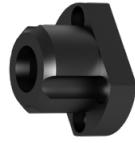
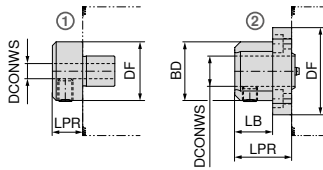

62 851 ...

DCONWS mm	KOMET no.	DF mm	BD mm	LPR mm	LB mm	Fig.	
6	M05 90200	31		16		1	00600
8	M05 90210	31		16		1	00800
10	M05 90220	46	31	25	15	2	01000
12	M05 90230	46	31	25	15	2	01200
16	M05 90240	46	31	30	20	2	01600

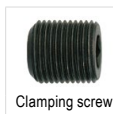

62 950 ...

62 950 ...

Spare parts

DCONWS		
6 - 8		44800
10 - 12	00000	44800
16	00000	14700

A detailed operating manual is available for download in the online shop next to the product.

MicroKom – Boring bar, vibration-optimised

▲ can only be used with adapter 62 851 ...
▲ with internal coolant supply

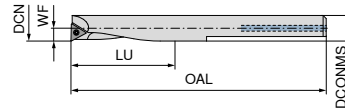

62 852 ...

DCN mm	KOMET no.	WF mm	LU mm	OAL mm	DCONMS mm	Insert	
5,6	B00 30280	2,80	22	65	6	WOHX 02T0..	10600
6,9	B00 30290	3,45	36	80	6	WOHX 02T0..	00600 ¹⁾
9,0	B00 00680	4,45	48	90	8	TO.X 06T1..	00800 ¹⁾
11,0	B00 00690	5,45	60	95	10	TO.X 06T1..	01000 ¹⁾

1) Carbide version



62 950 ...

Spare parts

Insert	
WOHX 02T0..	11800
TO.X 06T1..	09700

Suitable inserts can be found on → Page 57–59.

MicroKom – Carbide boring shank

▲ for boring head 62 854 ...
▲ can only be used with adapter 62 851 ...
▲ with internal coolant supply

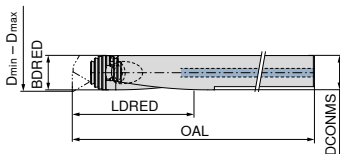

62 853 ...

D _{min} - D _{max} mm	KOMET no.	OAL mm	BDRED mm	LDRED mm	DCONMS mm	
13 - 17	G10 12060	120	12	75	12	01300
17 - 22	G10 12070	140	16	100	16	01700
22 - 26	G10 12080	140	16	100	16	02200



62 950 ...

Spare parts

DCONMS	
12	19700
16	19800

MicroKom – Boring head

▲ for boring shank 62 853 ...

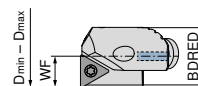

62 854 ...

D _{min} - D _{max} mm	KOMET no.	WF mm	BDRED mm	Insert	
13 - 15	G10 12621	6,45	12	TO.X 0902..	01300
15 - 17	G10 12841	7,45	12	TO.X 0902..	01500
17 - 19	G10 12711	8,45	16	TO.X 0902..	01700
19 - 22	G10 12861	9,45	16	TO.X 0902..	01900
22 - 26	G10 12731	10,95	16	TO.X 0902..	02200



62 950 ...

Spare parts

Insert	
TO.X 0902..	12000

Suitable inserts can be found on → Page 58+59.

MicroKom – Boring bar

- ▲ can only be used with adapter 62 851 ...
- ▲ with internal coolant supply

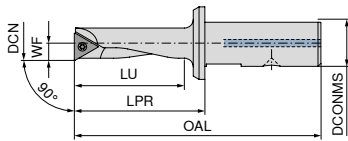

62 856 ...

DCN mm	KOMET no.	OAL mm	LPR mm	LU mm	DCONMS mm	WF mm	Insert	
5,6	B00 37010	48	26	20	8	2,75	WOHX 02T0..	05600
6,5	B00 37020	52	30	24	8	3,20	WOHX 02T0..	06500
8,0	B00 15510	57	35	28	8	3,95	TO.X 06T1..	08000
8,0	B00 15610	75	35	28	16	3,95	TO.X 06T1..	00800
10,0	B00 15620	80	40	33	16	4,95	TO.X 06T1..	01000
11,0	B00 15710	85	45	38	16	5,45	TO.X 0902..	01100
12,0	B00 15530	67	45	39	8	5,95	TO.X 0902..	11200
12,0	B00 15630	85	45	38	16	5,95	TO.X 0902..	01200
14,0	B00 15640	90	50	43	16	6,95	TO.X 0902..	01400
16,0	B00 15650	95	55	49	16	7,95	TO.X 0902..	01600
18,0	B00 15661	100	60	54	16	8,95	TO.X 0902..	01800
19,0	B00 15751	105	65	59	16	9,45	TO.X 0902..	01900
20,0	B00 15671	105	65	59	16	9,95	TO.X 0902..	02000
22,0	B00 15681	105	65	59	16	10,95	TO.X 0902..	02200
24,0	B00 15691	105	65	60	16	11,95	TO.X 0902..	02400



TORX® Screws

62 950 ...

Spare parts

DCN	
5,6 - 6,5	11800
8 - 10	12800
11 - 24	12000

Suitable inserts can be found on → Page 57–59.

MicroKom – Boring bar

- ▲ with thro' coolant

ABS

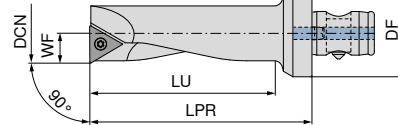

62 857 ...

DCN mm	KOMET no.	WF mm	DF mm	LU mm	LPR mm	Insert	
8	B00 25610	3,95	32	26	42	TO.X 06T1..	07989
9	B00 25700	4,45	32	32	48	TO.X 06T1..	21989
10	B00 25620	4,95	32	32	48	TO.X 06T1..	08989
11	B00 25710	5,45	32	41	57	TO.X 0902..	23989
12	B00 25630	5,95	32	41	57	TO.X 0902..	09989
14	B00 25640	6,95	32	49	64	TO.X 0902..	10989
16	B00 25650	7,95	32	57	72	TO.X 0902..	11989
18	B00 25661	8,95	32	57	72	TO.X 0902..	13989
20	B00 25671	9,95	32	67	82	TO.X 0902..	15989
22	B00 25681	10,95	32	68	82	TO.X 0902..	17989
24	B00 25691	11,95	32	68	82	TO.X 0902..	19989



TORX® Screws

62 950 ...

Spare parts

Insert	
TO.X 06T1..	12800
TO.X 0902..	12000

Suitable inserts can be found on → Page 58+59.

MicroKom – hi.flex micro – precision adjustment head

- ▲ for MicroKom boring bars and serrated bodies with DCONMS = 12 mm
- ▲ with thro' coolant supply
- ▲ LSCX = Recess depth of boring bar
- ▲ max. speed 30,000 rpm with slide in centre position
- ▲ UltraMini / EcoCut boring bar adapter for diameters from 0.5 mm

ABS

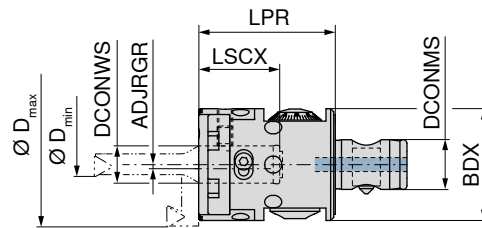

NEW
Analogue
62 800 ...

D _{min} - D _{max} mm	KOMET no.	Adapter	DCONWS mm	DCONMS mm	BDX mm	LPR mm	LSCX mm	ADJRGR mm	WT kg
0,5 - 60	M05 03000	ABS 32	12	16	36	44	26	-0,25 - 2,5	0,3

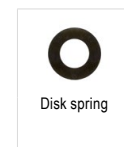

62 950 ...



62 950 ...

Spare parts
for Article no.
62 800 06089

Ø5,5x1,0

53700

M5x8 DIN913

53500

A detailed operating manual is available for download in the online shop next to the product.

Suitable ABS adapters can be found in → **Catalogue – Clamping technology, Chapter 16, Adaptors and Accessories.**

A detailed system overview you can find on → **Page 6.**

MicroKom – Precision spindle set hi.flex micro

Scope of supply:

- ▲ 1 plastic case
- ▲ 1 precision adjustment head
- ▲ 1 insert holder
 - 62 863 14400 Ø 25 – Ø 44 mm
- ▲ 3 boring bars
 - 62 845 00800 Ø 8 mm
 - 62 845 01400 Ø 14 mm
 - 62 845 02000 Ø 20 mm
- ▲ 2 adapters
 - 62 851 12499 Ø 4 mm
 - 62 851 12699 Ø 6 mm
- ▲ 1 serrated body
 - 62 861 04400 Ø 25 – Ø 44 mm
- ▲ 1 filling piece
 - 62 862 01200 Ø 12x24 mm
- ▲ 10 indexable inserts
 - 5 pieces 62 601 90206 – TOGX06T102EN-14 BK60
 - 5 pieces 62 601 70409 – TOGX090204EN-14 BK60
- ▲ 1 cylindrical screw
 - 62 950 53600 M5x16 mm
- ▲ 1 screwdriver
 - SW2,5

NEW



62 800 ...

D_{min} - D_{max}
mm
8 - 60

99989

MicroKom – UltraMini / EcoCut boring bar adapter

- ▲ for hi.flex micro
- ▲ 4 clamping flats (offset by 90°) on Ø DCONMS
- ▲ with thro' coolant supply

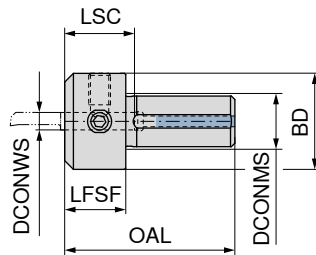

NEW

62 851 ...

DCONWS mm	KOMET no.	OAL mm	BD mm	LFSF mm	LSC mm	DCONMS mm	
4	M05 90900	39	22	14	18	12	12499
5	M05 90910	39	22	14	18	12	12599
6	M05 90920	39	22	14	18	12	12699
7	M05 90930	39	25	14	18	12	12799
8	M05 90940	39	25	14	18	12	12899



70 950 ...

Spare parts

DCONWS			
4 - 5	M5x10 ISO 4026		867
6 - 8	M8x1x8 - SW4		123

Suitable UltraMini / EcoCut tools can be found in → Chapters 10 and 12.

MicroKom – Boring bar for hi.flex micro

- ▲ with thro' coolant

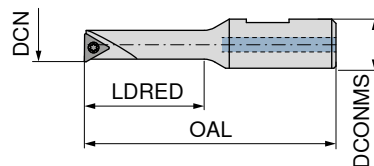

NEW

62 845 ...

DCN mm	KOMET no.	OAL mm	LDRED mm	DCONMS mm	Insert	
8	B05 80080	58,88	28,0	12	TO.X 06T1..	00800
14	B05 80140	70,00	39,5	12	TO.X 0902..	01400
20	B05 80200	85,00	54,4	12	TO.X 0902..	02000



62 950 ...

Spare parts

Insert		
TO.X 06T1..	M2x3,8/IP6	12800
TO.X 0902..	M2,6x5,2 - 08IP	12000

MicroKom – Serrated body for hi.flex micro

▲ with thro' coolant

Scope of supply:
without insert holder

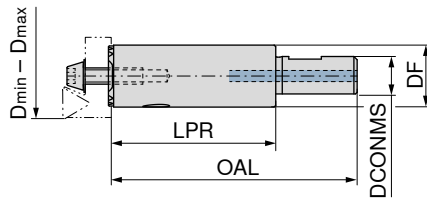

NEW

62 861 ...

04400

D _{min} - D _{max} mm	KOMET no.	DCONMS mm	OAL mm	LPR mm	DF mm
25 - 44	M05 90120	12	76,39	51,39	19



Cylindrical screw



Disk spring

62 950 ...

62 950 ...

Spare parts
DCONMS

12	M5x16	53600	10x5,2x0,3	19100
----	-------	-------	------------	-------

MicroKom – Insert holder for hi.flex micro

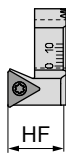

NEW

62 863 ...

14400

DCN mm	DCX mm	KOMET no.	HF mm	Insert
25	44	M05 20110	14,48	TO.. 0902



TORX® Screws

62 950 ...

Spare parts
Insert

TO.. 0902	09900
-----------	-------

MicroKom – Filling piece for hi.flex micro

▲ For targeted redirecting of the thro' coolant to the cutting edge when using insert holders with diameters from 45 mm

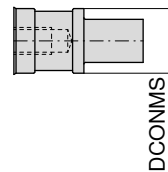

NEW

62 862 ...

01200

DCONMS mm	KOMET no.
12	M05 90700

Suitable inserts can be found on → Page 58+59.

MicroKom – M03Speed – precision adjustment head

Scope of supply:

Precision adjustment head with clamping screw
Please order insert holder and indexable insert separately

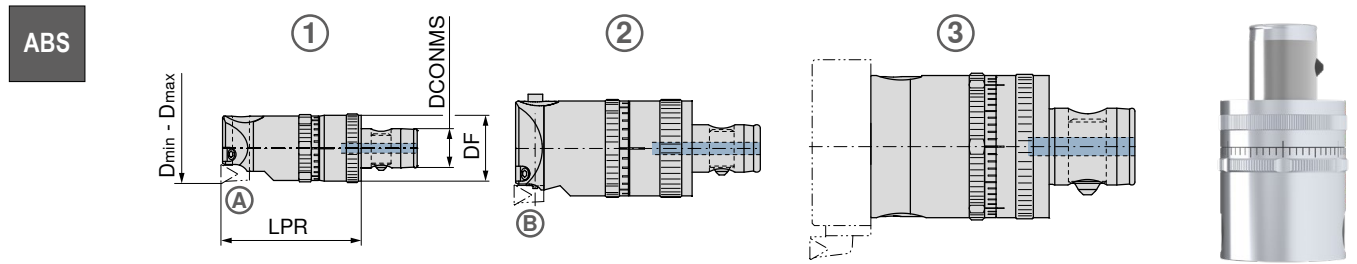

D _{min} - D _{max} mm	KOMET no.	Adapter	DCONMS mm	DF mm	LPR mm	Fig.	Suitable insert holders	WT kg	62 815 ...
24,8 - 33,0	M03 00115	ABS 25	13	25	50	1	62 864 03300	0,15	03390
29 - 39	M03 00515	ABS 25	13	25	50	1	62 864 03900	0,17	03990
38 - 50	M03 01025	ABS 32	16	32	60	2	62 864 05000	0,35	05089 ¹⁾
49 - 63	M03 01535	ABS 40	20	40	70	2	62 864 08000	0,63	06388 ¹⁾
62 - 80	M03 02045	ABS 50	28	50	75	2	62 864 08000	1,12	08097 ¹⁾
79 - 103	M03 02555	ABS 63	34	63	80	2	62 864 10300	1,91	10396 ¹⁾
38 - 63	M03 20170	ABS 32	16	32	81	3		0,35	06389 ²⁾
62 - 103	M03 20140	ABS 50	28	50	103	3		1,30	10397 ²⁾
100 - 206	M03 20090	ABS 63	34	63	106	3		1,91	20696 ²⁾

- 1) With dynamic balancing compensation
- 2) With dynamic balancing compensation / can only be used with interchangeable bridge (Art. No. 62 865 ...)

Spare parts for Article no.	TORX® Screws		Clamping screw		Grub screw	
	62 950 ...	62 950 ...	62 950 ...	62 950 ...	10 950 ...	10 950 ...
62 815 03390					M4x0,5	15600
62 815 03990					M4x0,5	15600
62 815 05089	M3,5x7,3 - 10IP	12600			M4x0,5	15600
62 815 06388	M3,5x7,3 - 10IP	12600			M5x0,5	15700
62 815 08097	M3,5x7,3 - 10IP	12600			M5x0,5	15700
62 815 10396	M5x9,4/IP6	45400			M6x8 - SW3	11300
62 815 06389			M8x10	37400		
62 815 10397			M8x10	37400		
62 815 20696	M5x9,4/IP6	45400	M8x10	37400		

- 1) The TORX® screws 62 950 12600 / 62 950 45400 are designed for mounting the insert holder on the precision adjustment head.
- 1) A detailed operating manual is available for download in the online shop next to the product.
- 1) Suitable ABS adapters can be found in → **Catalogue – Clamping technology, Chapter 16, Adaptors and Accessories.**
- 1) A detailed system overview you can find on → **Page 8.**

MicroKom – M03Speed – Insert holder

Scope of supply:
without inserts
incl. mounting screws

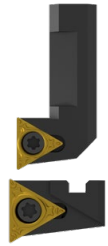
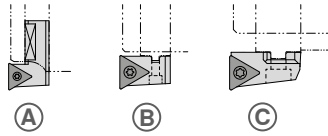

62 864 ...

For precision adjustment head	For precision adjustment head (with interchangeable bridge)	KOMET no.	Insert	Fig.	
62 815 03390		M03 10011	TO.. 06T1	A	03300
62 815 03990		M03 10021	TO.. 06T1	A	03900
62 815 05089	62 815 06389 (62 865 05100 / 62 865 06300)	M03 10033	TO.. 06T1	B	05000
62 815 06388 / 62 815 08097	62 815 10397 (62 865 08300 / 62 865 10300)	M03 10043	TO.. 0902	B	08000
62 815 10396		M03 10063	TO.. 0902	B	10300
	62 815 20696 (62 865 13000 / 62 865 16800 / 62 865 20600)	M03 10070	TO.. 0902	C	20600



62 950 ...

Spare parts
Insert

TO.. 06T1	M2x4,9/IP6	09700
TO.. 0902	M2,6x5,2 - 08IP	12000

Suitable inserts can be found on → Page 58+59.

MicroKom – M03Speed – Interchangeable bridge

Scope of supply:
without insert holder

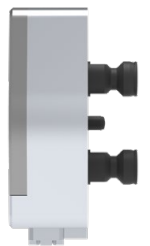
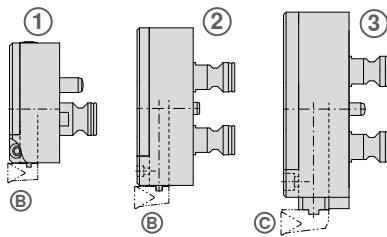

62 865 ...

D _{min} - D _{max} mm	KOMET no.	Fig.	WT kg	For precision adjustment head	Suitable insert holders	
38 - 51	M03 20180	1	0,06	62 815 06389	62 864 05000	05100
50 - 63	M03 20190	1	0,08	62 815 06389	62 864 05000	06300
62 - 83	M03 20150	2	0,20	62 815 10397	62 864 08000	08300
82 - 103	M03 20160	2	0,24	62 815 10397	62 864 08000	10300
100 - 130	M03 20100	3	0,39	62 815 20696	62 864 20600	13000
128 - 168	M03 20110	3	0,49	62 815 20696	62 864 20600	16800
166 - 206	M03 20120	3	0,59	62 815 20696	62 864 20600	20600

MicroKom – FF precision adjustment head

Scope of supply:

Head with clamping screw
Without precision turning insert

ABS

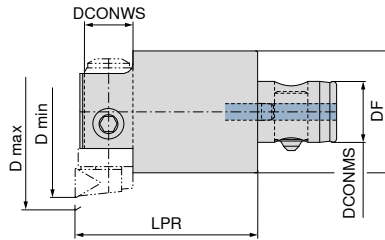

62 810 ...

D _{min} - D _{max} mm	KOMET no.	Adapter	DCONWS mm	DCONMS mm	DF mm	LPR mm	WT kg	
29,5 - 36	B30 11010	ABS 25	10	13	25	50	0,17	03690
35,5 - 42	B30 11020	ABS 25	10	13	25	50	0,18	04290
39 - 45	B30 12010	ABS 32	12	16	32	60	0,35	04589
44 - 50	B30 12020	ABS 32	12	16	32	60	0,35	05089
47 - 57	B30 13010	ABS 40	16	20	40	60	0,52	05788
56 - 66	B30 13020	ABS 40	16	20	40	60	0,52	06688
58 - 71	B30 14010	ABS 50	20	28	50	70	0,97	07197
70 - 83	B30 14020	ABS 50	20	28	50	70	1,05	08397
79 - 94	B30 15010	ABS 63	25	34	63	70	1,58	09496
93 - 108	B30 15020	ABS 63	25	34	63	70	1,61	10896
100 - 121	B30 16010	ABS 80	32	46	80	90	3,33	12192
120 - 141	B30 16020	ABS 80	32	46	80	90	3,37	14192
138 - 159	B30 17010	ABS 100	32	56	100	90	6,56	15991
158 - 179	B30 17020	ABS 100	32	56	100	90	6,80	17991
178 - 199	B30 17030	ABS 100	32	56	100	90	6,61	19991



62 950 ...

Spare parts for Article no.

62 810 03690	M6x6/SW3	44700
62 810 04290	M6x6/SW3	44700
62 810 04589	M8x8 - SW4	14700
62 810 05089	M8x10 - SW4	44800
62 810 05788	M10x10/SW5	44900
62 810 06688	M10x10/SW5	44900
62 810 07197	M12x12/SW6	45000
62 810 08397	M12x12/SW6	45000
62 810 09496	M16x16/SW8	45100
62 810 10896	M16x16/SW8	45100
62 810 12192	M20x20 - SW10	45200
62 810 14192	M20x20 - SW10	45200
62 810 15991	M20x30/SW10	45300
62 810 17991	M20x20 - SW10	45200
62 810 19991	M20x20 - SW10	45200



Suitable ABS adapters can be found in → **Catalogue – Clamping technology, Chapter 16, Adaptors and Accessories.**



A detailed system overview you can find on → **Page 8.**

MicroKom – FF precision turning insert

Scope of supply:

Precision turning insert with fixing screw
Please order indexable insert separately

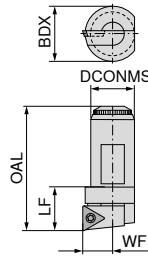

62 855 ...

5

for	DCONMS mm	KOMET no.	LF mm	WF mm	BDX mm	OAL mm	Insert	
62 810 0369 / 62 810 04290	10	M30 20011	11,0	7,5	14	28,5	TO.. 06T1	03000
62 810 04589 / 62 810 05089	12	M30 20021	12,5	9,0	16	37,5	TO.. 06T1	03900
62 810 05788 / 62 810 06688	16	M30 20031	16,0	11,0	20	45,0	TO.. 0902	04700
62 810 07197 / 62 810 08397	20	M30 20041	18,0	14,5	25	56,0	TO.. 0902	05800
62 810 09496 / 62 810 10896	25	M30 20051	21,6	16,0	32	77,5	TO.. 1403	07900
62 810 12192 / 62 810 14192	32	M30 20061	25,5	19,0	40	97,0	TO.. 1403	10000
62 810 15991 / 62 810 17991 / 62 810 19991	32	M30 20071	25,5	19,0	40	131,0	TO.. 1403	13800



TORX® Screws



Screwdriver

62 950 ...

80 950 ...

Spare parts
DCONMS

10	M2x3,8/IP6	12800		
12	M2x3,8/IP6	12800		
16	M2,6x5,2 - 08IP	12000	T08 - IP	060
20	M2,6x6,2 - 08IP	09900	T08 - IP	060
25	M3,5x7,3 - 10IP	12600	T10 - IP	062
32	M3,5x7,3 - 10IP	12600	T10 - IP	062



Suitable inserts can be found on → Page 58+59.

SpinTools – Micro-Boring Head

▲ max. speed 30,000 rev/min

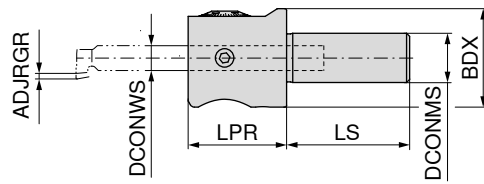

D _{min} - D _{max} mm	BDX mm	DCONWS mm	DCONMS mm	LPR mm	LS mm	ADJRGR mm	WT kg
0,3 - 7,1	25	4	10	25	25	0 - 1,7	0,10
0,3 - 19,1	32	7	16	32	40	0 - 2,75	0,25

Digital	Analogue
62 386 ...	62 382 ...
025	025
032	032



Clamping screw
ST

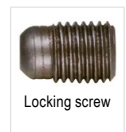

Locking screw

Spare parts for Article no.

62 382 025 / 62 386 025	M5x4	214	M4x8	228
62 382 032 / 62 386 032	M6x5	215	M6x10	229



A detailed system overview you can find on → **Page 7.**

SpinTools – Digital Stick

- ▲ suitable for all SpinTools digital heads as well as for hi.flex Digital
- ▲ revised software for even more precise adjustment

Scope of supply:
incl. AAA Battery



62 309 ...

00100



A detailed operating manual is available for download in the online shop next to the product.

SpinTools – Solid carbide boring bar

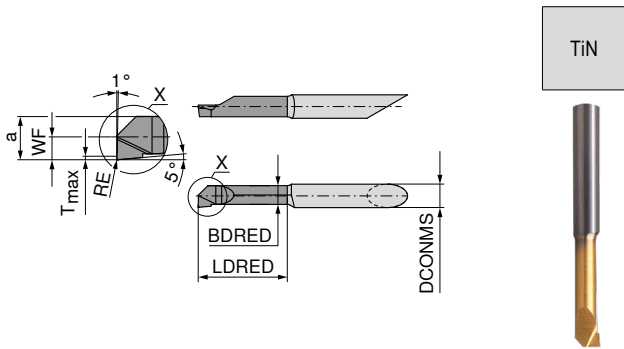

62 383 ...

D _{min} - D _{max} mm	DCONMS mm	LDRED mm	RE mm	a mm	BDRED mm	WF mm	T _{max} mm	
0,3 - 0,7	4	1,2		0,25	0,15	0,15	0,03	003
0,6 - 1,1	4	2,5		0,55	0,46	0,30	0,05	006
1,0 - 2,3	4	4,0	0,05	0,95	0,65	0,50	0,10	010
2,2 - 3,3	4	6,0	0,05	2,00	1,55	1,10	0,20	022
3,2 - 4,3	4	10,2	0,05	3,00	2,55	1,60	0,20	032
3,9 - 7,1	4	15,2	0,05	3,70	3,45	1,95	0,30	039
5,2 - 6,3	7	20,3	0,05	5,00	4,25	2,60	0,50	052
6,2 - 7,3	7	20,3	0,05	6,00	5,25	3,10	0,50	062
6,9 - 8,1	7	25,4	0,20	6,70	6,25	3,45	0,50	069

P	●
M	●
K	●
N	●
S	●
H	○
O	●

→ v_c Page 66

SpinTools – Carbide inserts

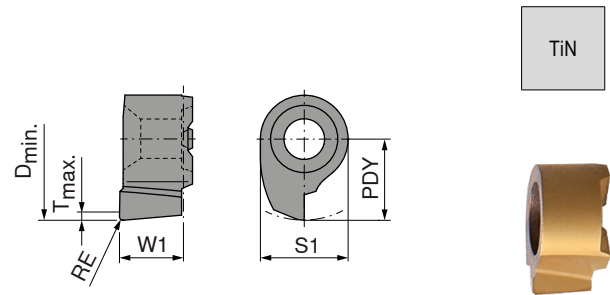

62 384 ...

D _{min} - D _{max} mm	RE mm	PDY mm	S1 mm	W1 mm	T _{max} mm	
6,9 - 8,1	0,2	3,45	4,8	3,5	1	069
7,9 - 9,1	0,2	3,95	4,8	3,5	1	079
8,9 - 10,1	0,2	4,45	4,8	3,5	1	089
9,9 - 12,1	0,2	4,95	7,0	3,9	1	099
11,9 - 14,1	0,2	5,95	7,0	3,9	1	119
13,9 - 19,1	0,2	6,95	7,0	3,9	1	139

P	●
M	●
K	●
N	●
S	●
H	○
O	●

→ v_c Page 66

SpinTools – Adapter

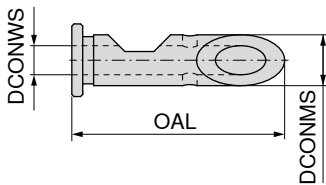

62 335 ...

DCONMS mm	DCONWS mm	OAL mm	
7	4	30	407

SpinTools – Toolholder for carbide inserts

- ▲ with thro' coolant
- ▲ appropriate inserts for article no. 62 384 ... can be found in the table above

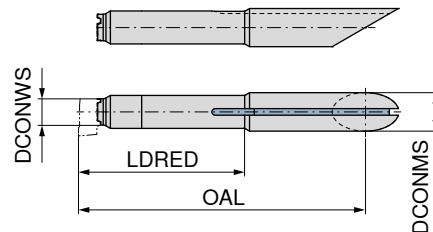

62 385 ...

DCONMS mm	LDRED mm	DCONWS mm	OAL mm	
7	30	4,8	56	330
7	35	7,0	61	350

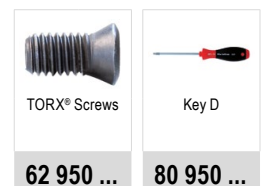

62 950 ...

80 950 ...

Spare parts
for Article no.

62 385 330	007	124
62 385 350	094	126

SpinTools – Precision boring head

▲ with thro' coolant

Scope of supply:

Fine boring head without shank, without insert holder

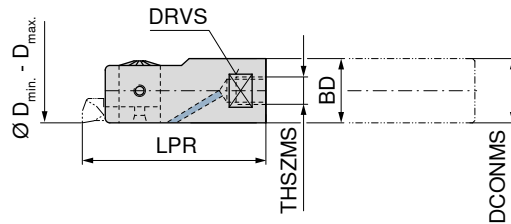

62 304 ...

BD mm	D _{min} - D _{max} mm	THSZMS	DCONMS	LPR	DRVS	WT kg
14	14,7 - 17,1	M6	14	39,8	12	0,05
16	16,7 - 20,1	M10	16	39,8	14	0,07
19	19,7 - 24,1	M10	18	39,8	16	0,09

017
020
024



TORX® Screws



Key D



Clamping screw
ST

62 950 ...

80 950 ...

62 950 ...

Spare parts for Article no.

62 304 017	M2,5x6	022	T07	109	M3x2	017
62 304 020	M2,5x6	022	T07	109	M3x2,5	018
62 304 024	M2,5x6	022	T07	109	M3x4	019

Information on the working length can be found on → **Page 73**.

A detailed system overview you can find on → **Page 9**.

SpinTools – Insert holder, 90°

Scope of supply:

without insert

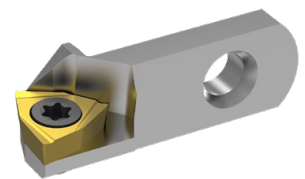
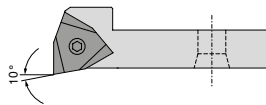

62 317 ...

Insert

WC.. 0201..

024

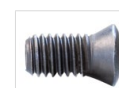

TORX® Screws



Key D

62 950 ...

80 950 ...

Spare parts Insert

WC.. 0201..	M2x3,7	021	T06	108
-------------	--------	-----	-----	-----

Suitable inserts can be found on → **Page 62**.

SpinTools – High-speed carbide boring bars

- ▲ with threaded mounting stud made of high quality steel
- ▲ with thro' coolant
- ▲ Shank clamping length 35 mm
- ▲ Boring shanks with DCONMS Ø 18 mm are for use in collet chuck or hydraulic chuck

Scope of supply:

boring shank, without boring head

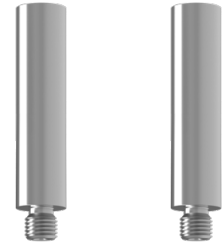
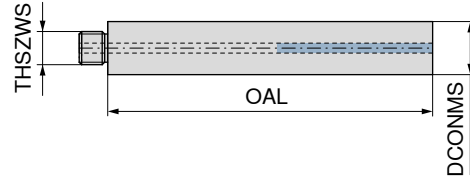

DCONMS mm	OAL mm	THSZWS
14	110	M6
16	120	M10
18	100	M10
18	140	M10
18	180	M10

62 353 ...	62 353 ...
014	
016	
	018
	118
	218

Information on the working length can be found on → **Page 73.**

SpinTools – Shank extensions (tempered steel)

- ▲ with thro' coolant

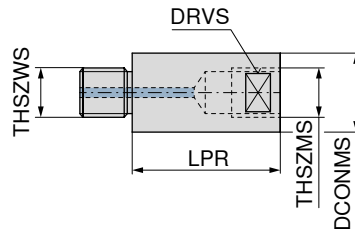

DCONMS mm	LPR mm	THSZWS	THSZMS	DRVS mm
16	32	M10	M10	14
16	64	M10	M10	14

62 349 ...
732
764

SpinTools – Multi-Head – boring and fine boring head

- ▲ For boring bars \varnothing 16 mm and bridges
- ▲ With internal coolant supply
- ▲ LSCX = Boring depth

Scope of supply:

without boring bar, bridge and insert holder

$D_{min} - D_{max}$ mm	Adapter	DCONMS mm	BDX mm	LPR mm	LB mm	LSCX mm	ADJRGR mm	WT kg	STM Modular 62 372 ...	HSK-A 62 373 ...	SK 62 373 ...	MAS-BT 62 373 ...
3 - 320	STM 36	36	63	71,6		111,6	0 - 2,7	1,69	653			
3 - 320	SK 40		63	91,6	72,5	81,6	0 - 2,7	1,90			153	
3 - 320	BT 40		63	91,6	69,0	81,6	0 - 2,7	2,20				453
3 - 320	HSK-A 63		63	96,6	70,6	73,0	0 - 2,7	1,90		653		

Spare parts

$D_{min} - D_{max}$
3 - 320

Clamping screw	Screw for drivers	Driver	Clamping screw MH	Flange screw
62 950 ...	62 950 ...	62 950 ...	62 950 ...	62 950 ...
227	167	040	226	225

Suitable base adapters can be found on → [page 50](#).

A detailed system overview you can find on → [Page 7](#).

SpinTools – Multi-Head – Boring and Fine Boring Head Set

▲ suitable for \varnothing 3 – \varnothing 320 mm

Scope of supply:

- ▲ 1 Tool Kit
- ▲ 1 Multi-Head-Boring- and Fine Boring Head (depending on selection)
- ▲ 4 Boring bars
 - 62 345 015 \varnothing 9.75 – \varnothing 15.1 mm
 - 62 345 020 \varnothing 14.75 – \varnothing 20.1 mm
 - 62 345 024 \varnothing 19.75 – \varnothing 25.1 mm
 - 62 345 029 \varnothing 24.75 – \varnothing 30.1 mm
- ▲ 2 Boring tools, adjustable
 - 62 375 048 \varnothing 29.75 – \varnothing 48.1 mm
 - 62 375 088 \varnothing 47.75 – \varnothing 88.1 mm
- ▲ incl. insert holder
 - 62 377 048 CC.. 0602
 - 62 377 088 CC.. 0602
- ▲ 1 Bridge
 - 62 376 164 \varnothing 86 – \varnothing 164 mm
- ▲ 1 Torx-Key – T7
- ▲ 1 6-adjustment key – SW5



$D_{min} - D_{max}$ mm	Adapter	STM Modular 62 374 ...	HSK-A 62 379 ...	SK 62 379 ...	MAS-BT 62 379 ...
9,75 - 164	HSK-A 63				
9,75 - 164	BT 40		996		993
9,75 - 164	SK 40			990	
9,75 - 164	STM 36	999			

SpinTools – Bridge for Multi-Head

- ▲ Ø adjustable
- ▲ With internal coolant supply

Scope of supply:
without tool holder
including fixation screws

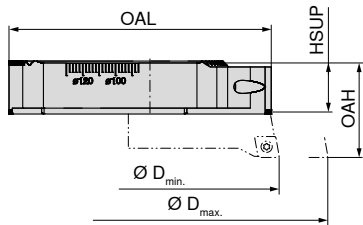

$D_{min} - D_{max}$ mm	OAL mm	HSUP mm	OAH mm	62 376 ...
86 - 164	80	15	29	164
162 - 320	158	15	29	320

SpinTools – Tool holder for boring bar and bridge Multi-Head

Scope of supply:
without inserts
incl. mounting screws

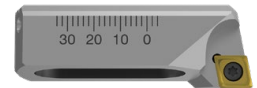
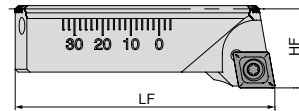

for	LF mm	HF mm	Insert	62 377 ...
62 375 048	28,2	12	CC.. 0602	048
62 375 088 / 62 376 ...	46,0	14	CC.. 0602	088
62 375 088 / 62 376 ...	46,0	14	CC.. 09T3	089

SpinTools – Counterweight

Scope of supply:
Including fixation screw

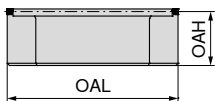
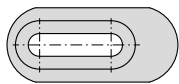

for	OAL mm	OAH mm	62 378 ...
62 376 ...	38	12	320

TORX® Screws	Key D	Flange screw	
62 950 ...	80 950 ...	62 950 ...	
for Article no. 62 377 048 / 62 377 088	022	109	225
62 377 089	023	113	225

Suitable inserts can be found on → Page 63.

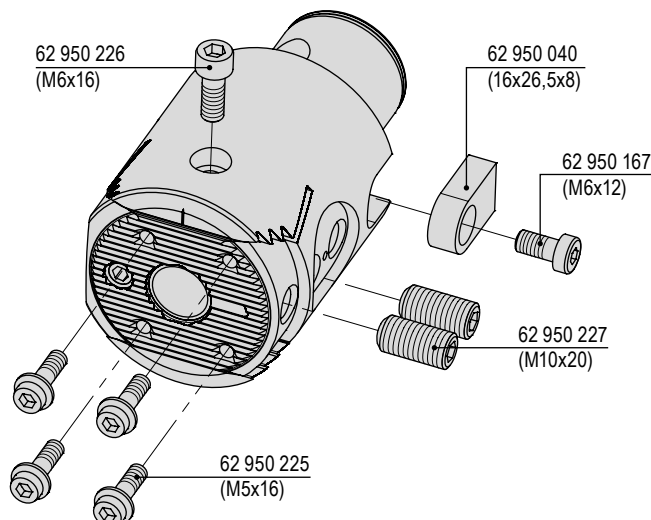

SpinTools – Single point boring heads – Modular system

- ▲ LSCX = Recess depth of boring bar
- ▲ With thro' coolant supply
- ▲ Digital variant: please order the digital stick separately

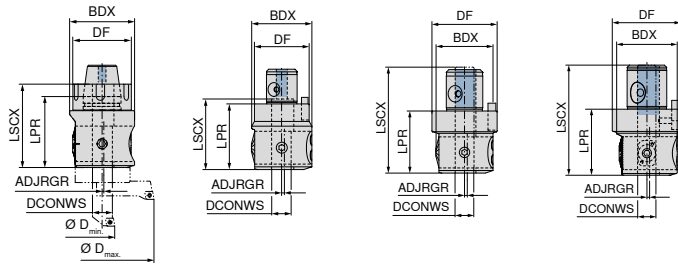

ER 32

without flange

with flange

Digital with collar



ER 32

without flange
STM Modular

with flange
STM Modular

Digital with collar
STM Modular

D _{min} - D _{max} mm	Adapter	BDX mm	DF mm	DCONWS mm	LPR mm	LSCX mm	ADJRGR mm	WT kg	62 332 ...	62 332 ...	62 332 ...	62 326 ...
3,0 - 88,1	ER 32	55	49,5	16	60	86,5	0 - 2,7	0,43	732			
3,0 - 88,1	STM 28	55	50,0	16	60	62,0	0 - 2,7	0,98		553		
3,0 - 88,1	STM 36	55	63,0	16	60	101,0	0 - 2,7	1,26			653	
3,0 - 88,1	STM 36	55	63,0	16	60	106,0	0 - 2,7	0,43				036

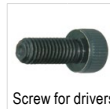

Spare parts for Article no.

Article no.	Part	Quantity
62 332 732	M10x16	047
62 332 553	M10x16	047
62 332 653	M10x16	047
62 326 036	M10x16	047
	M5x10	166
	M6x12	167
	M6x12	167
	12x20x6	039
	16x26,5x8	040
	16x26,5x8	040
	M10x8	046
	M10x8	046
	M10x8	046

Suitable base adapters can be found on → **page 50.**

A detailed system overview you can find on → **Page 7.**

SpinTools – Digital Stick

- ▲ suitable for all SpinTools digital heads as well as for hi.flex Digital
- ▲ revised software for even more precise adjustment

Scope of supply:
incl. AAA Battery



62 309 ...

00100

A detailed operating manual is available for download in the online shop next to the product.

SpinTools – Single point boring head – Monoblock analogue

- ▲ LSCX = Boring depth
- ▲ With internal coolant supply

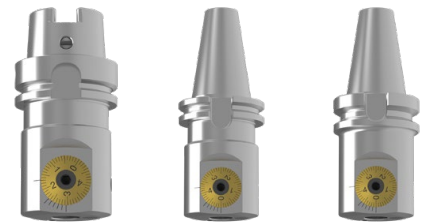
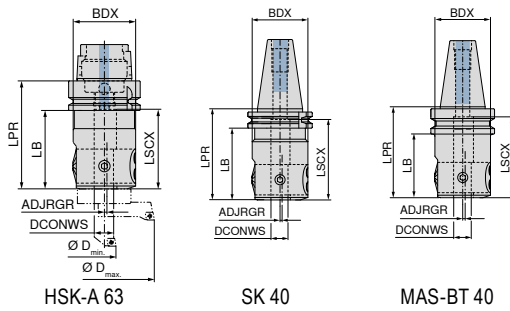

HSK-A 62 333 ... SK 62 333 ... MAS-BT 62 333 ...

D _{min} - D _{max} mm	Adapter	BDX mm	DCONWS mm	LPR mm	LB mm	LSCX mm	ADJRGR mm	WT kg
3,0 - 88,1	HSK-A 63	55	16	95	69	70	0 - 2,7	1,66
3,0 - 88,1	SK 40	55	16	90	70	80	0 - 2,7	1,83
3,0 - 88,1	BT 40	55	16	90	63	80	0 - 2,7	1,90

653 153 453



Clamping screw



Clamping screw ST

62 950 ...

62 950 ...

Spare parts

D_{min} - D_{max}
3,0 - 88,1

M10x16

047

M10x8

046

SpinTools – Single point boring head – Monoblock digital

- ▲ LSCX = Recess depth of boring bar
- ▲ With thro' coolant supply
- ▲ please order the digital stick separately

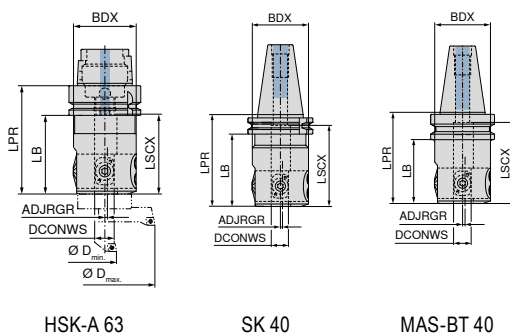

Digital HSK-A 62 363 ... Digital SK 62 363 ... Digital MAS-BT 62 363 ...

D _{min} - D _{max} mm	Adapter	BDX mm	DCONWS mm	LPR mm	LB mm	LSCX mm	ADJRGR mm	WT kg
3,0 - 88,1	HSK-A 63	55	16	95	70	70	0 - 2,7	1,66
3,0 - 88,1	SK 40	55	16	90	71	80	0 - 2,7	1,83
3,0 - 88,1	BT 40	55	16	90	59	80	0 - 2,7	1,90

688 188 488



Clamping screw



Clamping screw ST

62 950 ...

62 950 ...

Spare parts

D_{min} - D_{max}
3,0 - 88,1

M10x16

047

M10x8

046

A detailed system overview you can find on → Page 7.

SpinTools – Single point boring heads Set 1

- ▲ suitable for $\varnothing 3 - \varnothing 88.1$ mm
- ▲ supplied with $\varnothing 9.75 - \varnothing 30.1$ or $\varnothing 9.75 - \varnothing 40.1$ mm
- ▲ with thro' coolant

Scope of supply:

- ▲ 1 Tool Kit
- ▲ 1 single point boring head (depending on selection)
- ▲ 4 Boring bars (SK40- and MAS-BT-Set)
 - 62 345 015 $\varnothing 9.75 - \varnothing 15.1$ mm
 - 62 345 020 $\varnothing 14.75 - \varnothing 20.1$ mm
 - 62 345 024 $\varnothing 19.75 - \varnothing 25.1$ mm
 - 62 345 029 $\varnothing 24.75 - \varnothing 30.1$ mm
- ▲ 8 Boring bars (Modular-Set)
 - 62 345 015 $\varnothing 9.75 - \varnothing 15.1$ mm
 - 62 345 019 $\varnothing 13.75 - \varnothing 19.1$ mm
- 62 345 023 $\varnothing 17.75 - \varnothing 23.1$ mm
- 62 345 027 $\varnothing 21.75 - \varnothing 27.1$ mm
- 62 345 030 $\varnothing 24.75 - \varnothing 30.1$ mm
- 62 345 033 $\varnothing 27.75 - \varnothing 33.1$ mm
- 62 345 037 $\varnothing 31.75 - \varnothing 37.1$ mm
- 62 345 040 $\varnothing 34.75 - \varnothing 40.1$ mm
- ▲ 1 6-adjustment key – SW5
- ▲ 1 Torx-Key – T7



D _{min} - D _{max} mm	Adapter
9,75 - 30,1	SK 40
9,75 - 30,1	BT 40
9,75 - 40,1	STM 36

STM Modular	SK	MAS-BT
62 334 ...	62 345 ...	62 345 ...
999	990	993

SpinTools – Single point boring heads Set 2

- ▲ suitable for $\varnothing 3 - \varnothing 88.1$ mm
- ▲ Supplied with $\varnothing 9.75 - \varnothing 88.1$ mm
- ▲ with thro' coolant

Scope of supply:

- ▲ 1 Tool Kit
- ▲ 1 Fine boring head (depending on selection)
- ▲ 4 Boring bars
 - 62 345 015 $\varnothing 9.75 - \varnothing 15.1$ mm
 - 62 345 020 $\varnothing 14.75 - \varnothing 20.1$ mm
 - 62 345 024 $\varnothing 19.75 - \varnothing 25.1$ mm
 - 62 345 029 $\varnothing 24.75 - \varnothing 30.1$ mm
- ▲ 2 Boring tools, adjustable
 - 62 375 048 $\varnothing 29.75 - \varnothing 48.1$ mm
 - 62 375 088 $\varnothing 47.75 - \varnothing 88.1$ mm
- ▲ incl. insert holder
 - 62 377 048 CC.. 0602
 - 62 377 088 CC.. 0602
- ▲ 1 Torx key – T7
- ▲ 1 6-adjustment key – SW5



D _{min} - D _{max} mm	Adapter
9,75 - 88,1	HSK-A 63
9,75 - 88,1	BT 40
9,75 - 88,1	SK 40
9,75 - 88,1	STM 36

STM Modular	HSK-A	SK	MAS-BT
62 334 ...	62 345 ...	62 345 ...	62 345 ...
997	997	998	999

SpinTools – Single point boring heads ER32 Set

- ▲ Suitable for $\varnothing 3.0 - \varnothing 88.1$ mm
- ▲ Scope of supply $\varnothing 9.75 - \varnothing 30.1$ mm
- ▲ with thro' coolant supply

Scope of supply:

- ▲ 1 tool kit
- ▲ 1 single point boring head (62332732)
- ▲ 4 boring bars
 - 62 345 015 $\varnothing 9.75 - \varnothing 15.1$ mm
 - 62 345 020 $\varnothing 14.75 - \varnothing 20.1$ mm
 - 62 345 024 $\varnothing 19.75 - \varnothing 25.1$ mm
 - 62 345 029 $\varnothing 24.75 - \varnothing 30.1$ mm
- ▲ 1 Torx Key – T7
- ▲ 1 Allen Key – SW5



D _{min} - D _{max} mm	Adapter
9,75 - 30,1	ER 32

62 332 ...

999

SpinTools – Boring tools with carbide cutting edge

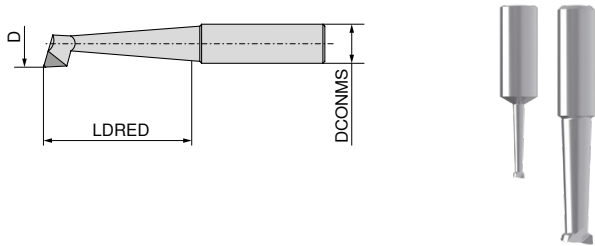

$D_{min} - D_{max}$ mm	LDRED mm	DCONMS _{h6} mm	62 346 ...
3,0 - 8,0	20	10	008
4,0 - 9,0	23	10	009
5,0 - 10,0	25	10	010
6,0 - 11,0	25	10	011
7,0 - 12,0	31	10	012

P	●
M	○
K	○
N	●
S	○
H	○
O	○

→ v_c Page 66

SpinTools – Adjustable boring bar bridge

▲ with thro' coolant

Scope of supply:
without insert holder

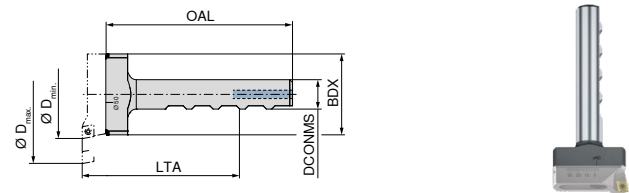

$D_{min} - D_{max}$ mm	OAL mm	BDX mm	LTA mm	DCONMS mm	62 375 ...
29,75 - 48,1	103	25	85	16	048
47,75 - 88,1	101	44	85	16	088

5

SpinTools – Tool holder for boring bar and bridge Multi-Head

Scope of supply:
without inserts
incl. mounting screws

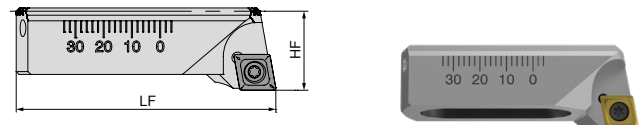

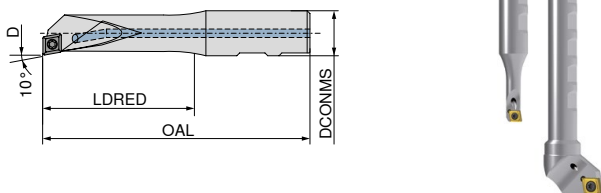

SpinTools – Steel boring bars

▲ with thro' coolant



$D_{min} - D_{max}$ mm	OAL mm	LDRED mm	DCONMS _{h6} mm	Insert	62 345 ...
9,75 - 15,1	75	30	16	CC.. 0602	015
11,75 - 17,1	80	37	16	CC.. 0602	017
13,75 - 19,1	85	43	16	CC.. 0602	019
14,75 - 20,1	90	51	16	CC.. 0602	020
15,75 - 21,1	95	57	16	CC.. 0602	021
17,75 - 23,1	100	67	16	CC.. 0602	023
19,75 - 25,1	105	72	16	CC.. 0602	024
19,75 - 25,1	105	72	16	CC.. 09T3	025
21,75 - 27,1	110	77	16	CC.. 09T3	027
24,75 - 30,1	115	82	16	CC.. 0602	029
24,75 - 30,1	115	82	16	CC.. 09T3	030
27,75 - 33,1	115	82	16	CC.. 09T3	033
31,75 - 37,1	115	82	16	CC.. 09T3	037
34,75 - 40,1	115	82	16	CC.. 09T3	040
38,75 - 44,1	115	82	16	CC.. 09T3	044
42,75 - 48,1	115	82	16	CC.. 09T3	048
47,75 - 53,1	115	82	16	CC.. 09T3	053

for	LF mm	HF mm	Insert	62 377 ...
62 375 048	28,2	12	CC.. 0602	048
62 375 088 / 62 376 ...	46,0	14	CC.. 0602	088
62 375 088 / 62 376 ...	46,0	14	CC.. 09T3	089

			
TORX® Screws	Key D	Flange screw	
62 950 ...	80 950 ...	62 950 ...	
Spare parts for Article no.			
62 377 048	022	109	225
62 377 088	022	109	225
62 377 089	023	113	225

 Suitable inserts can be found on → Page 63.

 Suitable inserts can be found on → Page 63.

SpinTools – Boring bars with carbide shank

- ▲ With internal coolant supply
- ▲ LTA = max. overhang

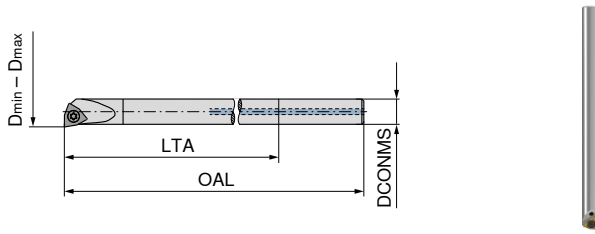

62 341 ...

D _{min} - D _{max} mm	DCONMS _{h6} mm	OAL mm	LTA mm	Insert	
5,8 - 11,2	5	80	45	WC.. 0201..	011
7,8 - 13,2	6	100	60	WC.. 0201..	013



TORX® Screws

62 950 ...



Key D

80 950 ...

Spare parts

Insert	
WC.. 0201..	021

SpinTools – Boring tool extensions

- ▲ with thro' coolant

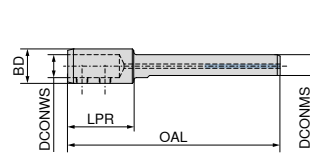

62 337 ...

DCONWS mm	DCONMS mm	BD mm	OAL mm	LPR mm	
10	16	16	128		128
16	16	24	148	44	148



Clamping screw

62 950 ...

Spare parts for Article no.

62 337 128	048
62 337 148	049

Suitable inserts can be found on → **Page 62.**

SpinTools – Reduction sleeves

- ▲ for boring bars and boring tools

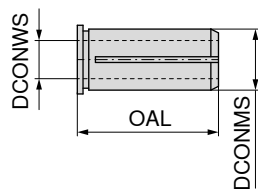

62 335 ...

DCONMS mm	DCONWS mm	OAL mm	
16	4	37	104
16	5	37	105
16	6	37	106
16	8	37	108
16	9	37	109
16	10	37	110
16	11	37	111
16	12	37	112
16	13	37	113
16	14	37	114

SpinTools – High-speed boring head

- ▲ for overturning holder and high speed carbide shank
- ▲ With internal coolant supply
- ▲ D_{max.} = using a head with fine adjustment 0 – 2,7 mm

Scope of supply:

Boring head without boring shank, without inserts

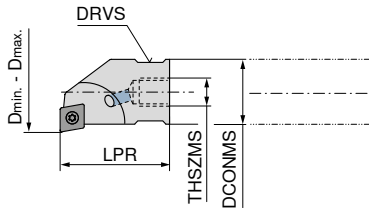

62 361 ...

D _{min} - D _{max} mm	LPR mm	THSZMS	DCONMS _{h6} mm	Insert	
8,75 - 14,1	18	M5	8	CC.. 0602	014
9,75 - 15,1	18	M5	9	CC.. 0602	015
10,75 - 16,1	23	M6	10	CC.. 0602	016
11,75 - 17,1	23	M6	11	CC.. 0602	017
12,75 - 18,1	23	M6	12	CC.. 0602	018
13,75 - 19,1	23	M6	13	CC.. 0602	019
14,75 - 20,1	23	M6	14	CC.. 0602	020
15,75 - 21,1	23	M6	14	CC.. 0602	021
16,75 - 22,1	27	M10	16	CC.. 0602	022
17,75 - 23,1	27	M10	16	CC.. 0602	023
19,75 - 25,1	27	M10	16	CC.. 0602	025
21,75 - 27,1	27	M10	16	CC.. 0602	027
24,75 - 30,1	27	M10	16	CC.. 0602	030
27,75 - 33,1	27	M10	16	CC.. 0602	033
31,75 - 37,1	27	M10	16	CC.. 0602	037
34,75 - 40,1	27	M10	16	CC.. 0602	040



TORX® Screws

62 950 ...

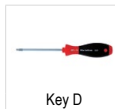

Key D

80 950 ...

Spare parts

Insert

CC.. 0602

022

109

Suitable inserts can be found on → Page 63.

SpinTools – High-speed carbide boring bars

- ▲ with threaded mounting stud made of high quality steel
- ▲ with thro' coolant
- ▲ Shank clamping length 35 mm

Scope of supply:

boring shank, without boring head

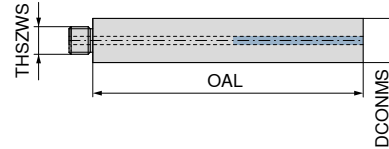

62 353 ...

DCONMS mm	OAL mm	THSZWS	
8	73	M5	008
9	80	M5	009
10	82	M6	010
11	89	M6	011
12	96	M6	012
13	103	M6	013
14	110	M6	014
16	120	M10	016



Information on the working length can be found on → Page 73.

SpinTools – Single point finish boring heads

- ▲ With thro' coolant supply
- ▲ Digital variant: please order the digital stick separately

Scope of supply:
without insert holder and inserts

STM

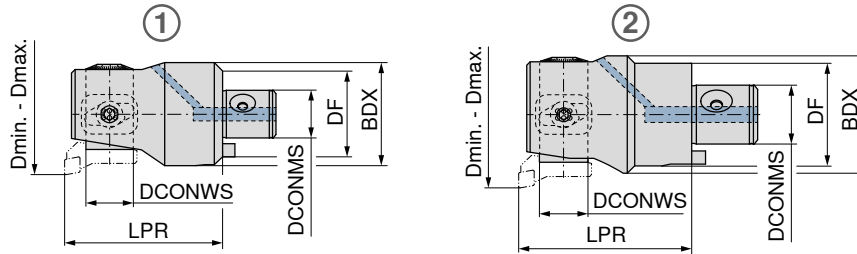

Analogue Digital

D _{min} - D _{max} mm	D _{min} - D _{max} extended mm	Adapter	DCONMS mm	BDX mm	DF mm	LPR mm	DCONWS mm	WT kg	Fig.	62 303 ...	62 308 ...
23,9 - 31,1	29,9 - 37,1	STM 11	11	22,5	20	40	11	0,08	1	031	031
30,9 - 40,1	37,9 - 47,1	STM 14	14	29,0	25	45	13	0,15	1	040	040
39,9 - 51,1	47,9 - 59,1	STM 18	18	37,0	32	65	17	0,38	1	051	051
50,9 - 67,1	64,9 - 81,1	STM 22	22	47,0	40	72	22	0,70	1	067	067
66,9 - 87,1	84,9 - 105,1	STM 28	28	59,0	50	82	30	1,32	2	087	087
86,9 - 116,1	104,9 - 134,1 (124,9 - 154,1)	STM 36	36	72,0	63	105	30	3,15	2	116	116

i For optimal stability when fine boring the main insert holder ranges are preferred over the extended range.

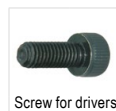

Screw for drivers

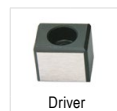

Driver



Fillister-head screw



Clamping screw ST

62 950 ...	62 950 ...	62 950 ...	62 950 ...
------------	------------	------------	------------

Spare parts for Article no.

62 303 031 / 62 308 031	M2x2,5	162	5x8,5x3	035	M4x6	287	M4x3	213
62 303 040 / 62 308 040	M2,5x6	163	6x10,3x4	036	M5x8	288	M5x4	214
62 303 051 / 62 308 051	M3x8	164	8x15x5	037	M6x10	289	M6x5	215
62 303 067 / 62 308 067	M4x10	165	10x18,1x6	038	M8x12	290	M8x6	216
62 303 087 / 62 308 087	M5x10	166	12x20x6	039	M10x16	291	M10x10	217
62 303 116 / 62 308 116	M6x12	167	16x26,5x8	040	M10x16	291	M10x18	218

i Suitable base adapters can be found on → **page 50.**

i A detailed system overview you can find on → **Page 9.**

SpinTools – Digital Stick

- ▲ suitable for all SpinTools digital heads as well as for hi.flex Digital
- ▲ revised software for even more precise adjustment

Scope of supply:
incl. AAA Battery



62 309 ...

00100

i A detailed operating manual is available for download in the online shop next to the product.

SpinTools – Insert holder, 90° and 95°

▲ for single point finish boring heads Art. 62 303 ..., 62 308 ...

Scope of supply:

incl. Torx clamping screw for inserts, without fixing bolt for holder

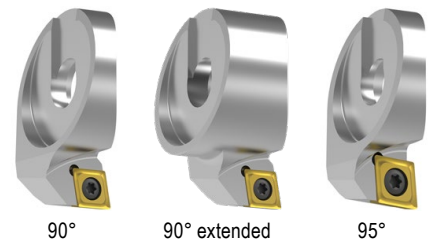
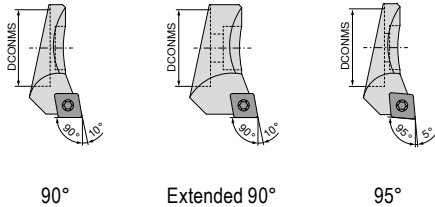

5

DCONMS mm	Insert
11	CC.. 0602
13	CC.. 0602
17	CC.. 0602
22	CC.. 0602
30	CC.. 0602
30	CC.. 09T3
30	CC.. 09T3

62 318 ...	62 318 ...	62 320 ...
031	037	031
040	047	040
051	059	051
067	081	067
087	105	
116	134	087
	154	



TORX® Screws

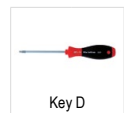

Key D

Spare parts

Insert

CC.. 0602	M2,5x6	022	T07	109
CC.. 09T3	M4x9	023	T15	113

Suitable inserts can be found on → **Page 63.**

SpinTools – High-speed carbide boring tools

▲ Shaft extension for single point finish boring heads Art. No. 62 303 ..., 62 308 ...

▲ with thro' coolant supply

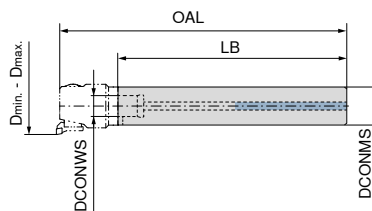

D _{min} - D _{max} mm	DCONWS mm	DCONMS mm	OAL mm	LB mm	WT kg
23,9 - 31,1	11	20	250	210	0,81
30,9 - 40,1	14	25	306	261	1,54
39,9 - 51,1	18	32	380	315	3,03

62 354 ...

020
025
032

SpinTools – Reverse adapter for back boring

▲ For insert holder article nos. 62 318 ... / 62 320 ...

Scope of supply:

Adapter including fixing bolt

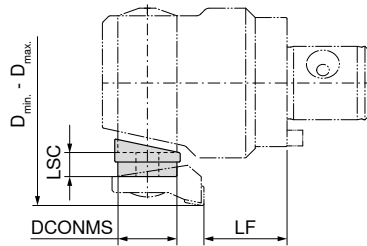

62 321 ...

LSC mm	DCONMS mm	LF mm	D _{min} - D _{max} mm	
6,5	11	13,0	37 - 44	044
8,0	11	13,0	40 - 47	051
6,5	13	12,6	44 - 53	053
10,0	13	12,6	51 - 60	060
6,5	17	31,3	53 - 64	064
10,0	17	31,3	60 - 71	071
6,5	22	31,2	68 - 80	080
12,0	22	31,2	75 - 91	091
10,0	30	29,0	87 - 107	107

 Note left hand direction of spindle rotation when in use

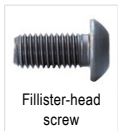

62 950 ...

Spare parts for Article no.		
62 321 044	M4x12	278
62 321 051	M4x13	279
62 321 053	M5x14	280
62 321 060	M5x16	281
62 321 064	M6x15	282
62 321 071	M6x20	283
62 321 080	M8x20	284
62 321 091	M8x25	285
62 321 107	M10x30	286

Minimum diameter (Ø D1) during retraction for back boring

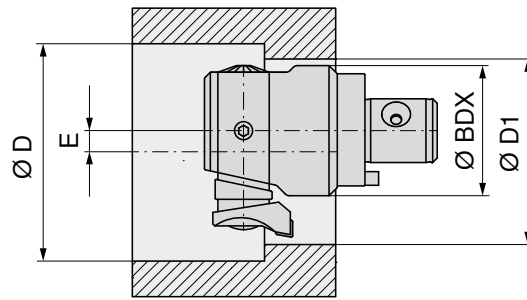

5

Minimum diameter (Ø D1) of the entry bore

$$\varnothing D1 = \frac{\varnothing BDX + \varnothing D}{2} + 1^*$$

*Safety margin

Minimum offset (E) for starting

$$E = \frac{\varnothing D - \varnothing D1}{2} + 0,5^*$$

Example

Single point finish boring head

62 303 031 (Ø BDX = 22,5 mm)

Reverse adapter

Selected

62 321 044 (Ø D_{min} - Ø D_{max} = 37 - 44 mm)

Ø D = 37 mm

Insert holder

62 318 031

$$\varnothing D1 = \frac{\varnothing 22,5 \text{ mm} + \varnothing 37 \text{ mm}}{2} + 1 \text{ mm} = 30,75 \text{ mm}$$

$$E = \frac{\varnothing 37 \text{ mm} - \varnothing 30,75 \text{ mm}}{2} + 0,5 \text{ mm} = 3,625 \text{ mm}$$

SpinTools – Single point finish boring heads

- ▲ With internal coolant supply
- ▲ extremely stable connection between insert holder and boring head

Scope of supply:

Boring head, without insert holder, pressure plate and support

STM

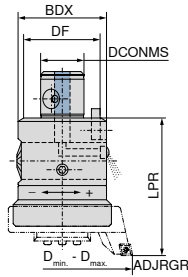

STM Modular
62 305 ...

D _{min} - D _{max} mm	Adapter	DCONMS mm	BDX mm	DF mm	LPR mm	ADJRGR mm	WT kg	
86 - 402	STM 36	36	72	63	120	± 1,25	2,94	302



Cylindrical screw



Screw for drivers



Driver



Clamping screw
ST

Spare parts for Article no.

62 305 302	M8x45	292	M6x12	167	16x26,5x8	040	M8x60	011
------------	-------	------------	-------	------------	-----------	------------	-------	------------

Suitable base adapters can be found on → **page 50.**

A detailed system overview you can find on → **Page 9.**

SpinTools – Boring set

- ▲ suitable for Ø 86 – Ø 402 mm
- ▲ supplied with Ø 86 – Ø 302 mm
- ▲ with thro' coolant

Scope of supply:

- ▲ 1 Case
- ▲ 1 single point finish boring head
 - 62 305 302
- ▲ 3 insert holders
 - 62 438 138 Ø 86 – Ø 138 mm
 - 62 438 220 Ø 136 – Ø 220 mm
 - 62 438 302 Ø 188 – Ø 302 mm
- ▲ 2 pressure plates and 2 supports
 - 62 950 149
 - 62 950 150
 - 62 950 152
 - 62 950 153
- ▲ 1 Allen Key – SW5
- ▲ 1 Torx Key – T15



STM Modular
62 439 ...

D _{min} - D _{max} mm	Adapter	
86 - 302	STM 36	999

SpinTools – Tool holder

- ▲ for single point finish boring heads
- ▲ Approach angle 90°

Scope of supply:

incl. cover plate and support

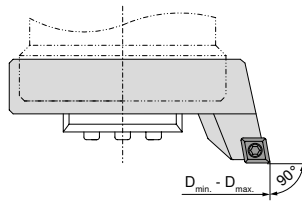

62 438 ...

D _{min} - D _{max} mm	Insert	
86 - 138	CC.. 09T3	138
136 - 220	CC.. 09T3	220
188 - 302	CC.. 09T3	302
242 - 402	CC.. 09T3	402

5



62 950 ...

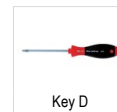

80 950 ...



62 950 ...

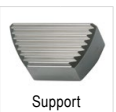

62 950 ...

**Spare parts
for Article no.**

Article no.	TORX® Screws	Key D	Pressure plate	Support
62 438 138	M4x9 023	T15 113	152	149
62 438 220	M4x9 023	T15 113	153	150
62 438 302	M4x9 023	T15 113	153	150
62 438 402	M4x9 023	T15 113	153	150

Suitable inserts can be found on → **Page 63.**

TwinKom – Base body

Scope of supply:

Clamping plate incl. adjustment and fixing screws
Order tool holder (+indexable insert) and indexable inserts separately

ABS

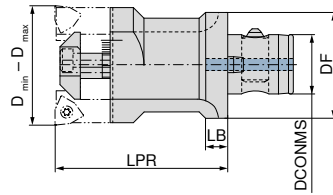

D _{min} - D _{max} mm	KOMET no.	DCONMS mm	DF mm	Adapter	LPR mm	LB mm	WT kg	62 870 ...	
								long	short
24 - 32	G01 70552	13	25	ABS 25	45	6,0	0,11		03290
24 - 32	G01 71072	16	32	ABS 32	70	7,0	0,21	13289	
30 - 41	G01 70562	13	25	ABS 25	50		0,12		04190
30 - 41	G01 71132	16	32	ABS 32	85	7,5	0,30	14189	
39 - 53	G01 71022	16	32	ABS 32	60		0,29		05389
39 - 53	G01 71622	20	40	ABS 40	120	8,0	0,68	15388	
51 - 71	G01 71522	20	40	ABS 40	60		0,44		07188
51 - 71	G01 72122	28	50	ABS 50	135	10,0	1,24	17197	
64 - 91	G01 72022	28	50	ABS 50	70		0,82		09197
64 - 91	G01 72622	34	63	ABS 63	155	13,0	2,25	19196	
83 - 124	G01 72522	34	63	ABS 63	70		1,35		12496
83 - 124	G01 73122	46	80	ABS 80	155	16,5	3,80	12592	
109 - 167	G01 73032	46	80	ABS 80	90		3,10		16792 ¹⁾
109 - 167	G01 73042	46	80	ABS 80	175		6,20	16892 ¹⁾	
139 - 215	G01 73562	56	100	ABS 100	125		6,47		21591 ¹⁾
139 - 215	G01 73572	56	100	ABS 100	240		13,25	21691 ¹⁾	

1) Diameter range can only be achieved with TwinKom basic tool holder (radially + axially adjustable) and corresponding indexable insert!

D _{min} - D _{max} mm	Spare parts	10 950 ...			62 950 ...			10 950 ...		
		Adjustment screw	TwinKom clamping plate	Fixing screw	Adjustment screw	TwinKom clamping plate	Fixing screw	Adjustment screw	TwinKom clamping plate	Fixing screw
24 - 32	M2,5X5.SW1,3	16500	46900	M2x4,5 - T06	15800					
30 - 41	M2,5X5.SW1,3	16500	47000	M2,5x5,3 - T08	15900					
39 - 53	M4x8 - SW2	11100	47100	M2,5x7 - T08	16000					
51 - 71	M4x10 - SW2	11200	47200	M3,5x9,4 - T10	16300					
64 - 91	M6X12 SW3	16100	47300	M4,5x11,5 - T15	13500					
83 - 124	M6X20 SW3	16200	47400	M5x12 - SW2,5	11000					
109 - 167	M8X20.SW4	16600	47500							
139 - 215	M10X20 DIN 913	17500	47700	M6x20 Sw5	17600					

D _{min} - D _{max} mm	Spare parts	62 950 ...			62 950 ...			62 950 ...		
		Cylindrical screw TwinKom	Cylindrical screw	Adjustment pin	Cylindrical screw	Adjustment pin	Cylindrical screw	Adjustment pin	Cylindrical screw	Adjustment pin
24 - 32	M3X16	46000								46200
30 - 41	M4X20	45500								46300
39 - 53	M5X25	45600								46400
51 - 71	M6X30	45700								46500
64 - 91	M8X35	45800								46600
83 - 124	M8X45	45900								46700
109 - 167	M10X50	46100	M5x16	00000						46800
139 - 215	M12x60	47600								47800

A detailed operating manual is available for download in the online shop next to the product.

A detailed system overview you can find on → **Page 10**.

TwinKom – Tool holder 90°

- ▲ radially adjustable
- ▲ Price per piece

Scope of supply:

including clamping screw
Order indexable inserts separately

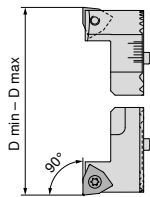

62 871 ...

D _{min} - D _{max} mm	KOMET no.	Insert	
24 - 32	G03 70330	WO.X 0403..	03200
30 - 41	G03 70141	WO.X 05T3..	04100
39 - 53	G03 70230	WO.X 05T3..	05300
51 - 71	G03 70240	WO.X 06T3..	07100
64 - 91	G03 70250	WO.X 0804..	09100
83 - 124	G03 70260	WO.X 1005..	12400

TwinKom – Tool holder 80°

- ▲ radially adjustable
- ▲ Price per piece

Scope of supply:

including clamping screw
Order indexable inserts separately

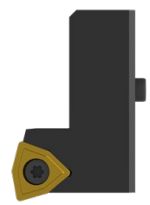
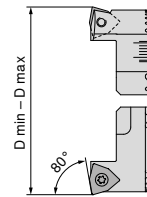

62 875 ...

D _{min} - D _{max} mm	KOMET no.	Insert	
24 - 32	G03 80310	WO.X 0403..	03200
30 - 41	G03 80021	WO.X 05T3..	04100
39 - 53	G03 80090	WO.X 05T3..	05300
51 - 71	G03 80100	WO.X 06T3..	07100
64 - 91	G03 80110	WO.X 0804..	09100
83 - 124	G03 80120	WO.X 1005..	12400



Clamping screw

10 950 ...

Spare parts

D _{min} - D _{max}		
24 - 32	M2,2x5,5 - 06IP	10700
30 - 41	M2,5x7,2 - 08IP	10500
39 - 53	M2,5x7,2 - 08IP	10500
51 - 71	M3,5x7,3 - 10IP	10600
64 - 91	M4,5x9 - 15IP	12700
83 - 124	M4,5x9 - 15IP	12700

1 You can find the suitable indexable inserts and usage recommendations on → **Page 60+61.**

1 Suitable ABS adapters can be found in → **Catalogue – Clamping technology, Chapter 16, Adaptors and Accessories.**

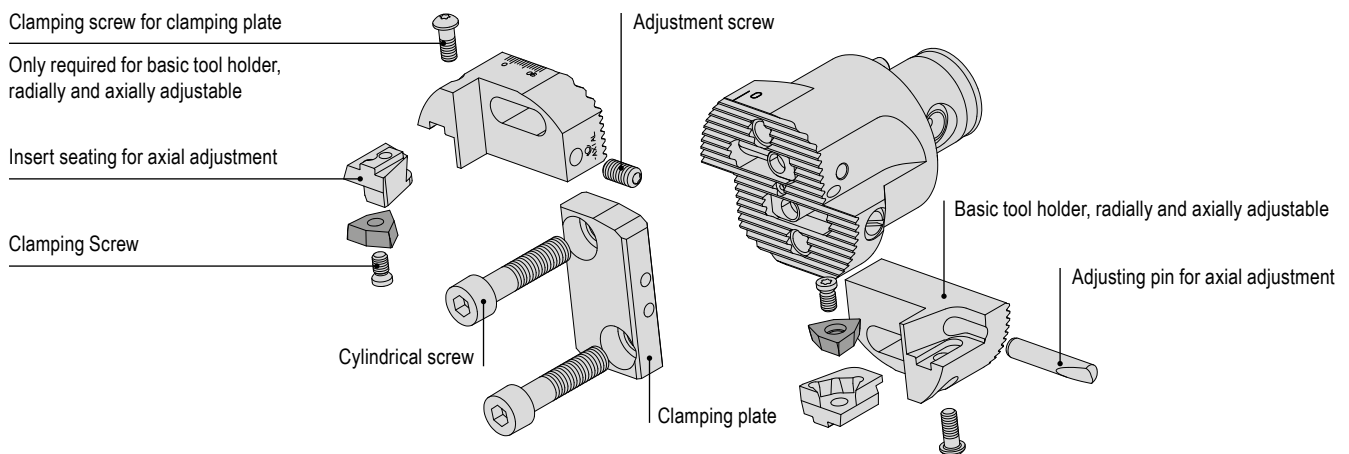

TwinKom – Basic tool holder, radially and axially adjustable

▲ Price per piece

Scope of supply:

Order indexable insert seats and indexable inserts separately

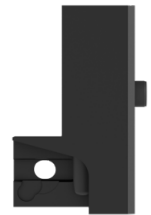
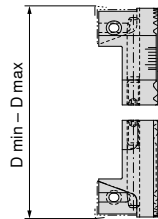

62 872 ...

D _{min} - D _{max} mm	KOMET no.	
24 - 32	G03 70011	03200
30 - 41	G03 70021	04100
39 - 53	G03 70031	05300
51 - 71	G03 70041	07100
64 - 91	G03 70061	09100
83 - 124	G03 70071	12400
109 - 167	G03 70081	16700
139 - 215	G03 70091	21500

TwinKom – Indexable insert, 90°

▲ axially adjustable

▲ Price per piece

Scope of supply:

including clamping screw

Order indexable inserts separately

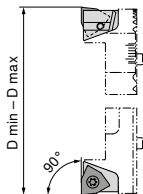

TwinKom – Indexable insert, 80°

▲ axially adjustable

▲ Price per piece

Scope of supply:

including clamping screw

Order indexable inserts separately

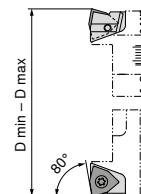

62 873 ...

D _{min} - D _{max} mm	KOMET no.	Insert	
24 - 32	D54 60510	WO.X 0302..	03200
30 - 41	D54 60520	WO.X 0403..	04100
39 - 53	D54 60030	WO.X 05T3..	05300
51 - 71	D54 60040	WO.X 06T3..	07100
64 - 91	D54 60050	WO.X 0804..	09100
83 - 167	D54 60060	WO.X 1005..	12400
139 - 215	D54 60070	WO.X 1206..	21500

62 874 ...

D _{min} - D _{max} mm	KOMET no.	Insert	
24 - 32	D54 60610	WO.X 0302..	03200
30 - 41	D54 60620	WO.X 0403..	04100
39 - 53	D54 60130	WO.X 05T3..	05300
51 - 71	D54 60140	WO.X 06T3..	07100
64 - 91	D54 60150	WO.X 0804..	09100
83 - 167	D54 60160	WO.X 1005..	16700
139 - 215	D54 60170	WO.X 1206..	21500

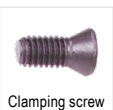

Clamping screw

10 950 ...

Spare parts

D _{min} - D _{max}		
24 - 32	M2,0x4,3 - 06IP	10000
30 - 41	M2,2x5,5 - 06IP	10700
39 - 53	M2,5x6,3 - 08IP	10800
51 - 71	M3,5x6,6 - 10IP	16400
64 - 91	M4,5x9 - 15IP	12700
83 - 167	M4,5x9 - 15IP	12700
139 - 215	M5,5x11 - 20IP	17400

SpinTools – Boring heads for roughing with 2 cutting edges

▲ with thro' coolant

Scope of supply:

Boring head incl. drive dog, fixing screws, spring rings, drive dog screw and stop pin

STM

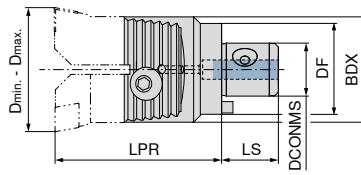

62 295 ...

D _{min} - D _{max} mm	Adapter	DCONMS mm	BDX mm	DF mm	LPR mm	LS mm	WT kg	
23,5 - 30,5	STM 11	11	20	20	40	13	0,05	030
29,5 - 40,1	STM 14	14	25	25	45	16	0,09	040
39,5 - 50,5	STM 18	18	32	32	65	20	0,25	050
49,5 - 66,5	STM 22	22	42	40	72	24	0,38	066
65,5 - 87,5	STM 28	28	55	50	82	30	0,59	087

5



62 950 ...



62 950 ...

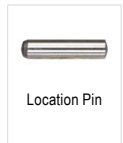

62 950 ...

Spare parts for Article no.

62 295 030	M4x8	298	Ø 4,3/7,3	311	231
62 295 040	M5x12	293	Ø 5,3/9,3	312	231
62 295 050	M6x16	294	Ø 6,4/10,2	313	231
62 295 066	M8x20	295	Ø 8,4/14,0	314	234
62 295 087	M10x25	296	Ø 10,5/17,0	315	234

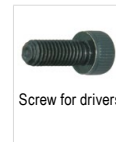

62 950 ...



62 950 ...

Spare parts for Article no.

62 295 030	M2x2,5	162	5x8,5x3	035
62 295 040	M2,5x6	163	6x10,3x4	036
62 295 050	M3x8	164	8x15x5	037
62 295 066	M4x10	165	10x18,1x6	038
62 295 087	M5x10	166	12x20x6	039

Suitable base adapters can be found on → **page 50.**

A detailed system overview you can find on → **Page 10.**

SpinTools – Pair of tool holders, standard, 90°

Scope of supply:

Adjustment screws, positioning pin, insert clamping screws

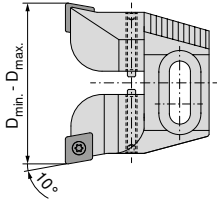

62 296 ...

D _{min} - D _{max} mm	Insert	
23,5 - 30,5	CC.. 0602	030
29,5 - 40,1	CC.. 0602	040
39,5 - 50,5	CC.. 09T3	050
49,5 - 66,5	CC.. 09T3	066
65,5 - 87,5	CN.. 1204	088
65,5 - 87,5	CC.. 1204	087

SpinTools – Pair of tool holders, standard, 70°

Scope of supply:

Adjustment screws, positioning pin, insert clamping screws

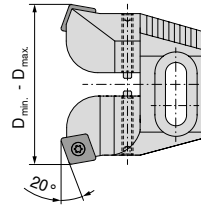

62 299 ...

D _{min} - D _{max} mm	Insert	
23,5 - 30,5	CC.. 0602	030
29,5 - 40,1	CC.. 0602	040
39,5 - 50,5	CC.. 09T3	050
49,5 - 66,5	CC.. 09T3	066
65,5 - 87,5	CN.. 1204	088
65,5 - 87,5	CC.. 1204	087



TORX® Screws



Key D

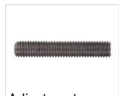

Adjustment screw

62 950 ...

80 950 ...

62 950 ...

Spare parts

D _{min} - D _{max}	Insert						
23,5 - 30,5	CC.. 0602	M2,5x6	022	T07	109	M4x0,5x7	238
29,5 - 40,1	CC.. 0602	M2,5x6	022	T07	109	M4x0,5x9,5	239
39,5 - 50,5	CC.. 09T3	M4x9	023	T15	113	M4x0,5x13	240
49,5 - 66,5	CC.. 09T3	M4x9	023	T15	113	M6x14	241
65,5 - 87,5	CC.. 1204	M5x10	232	T20	114	M6x20	242



Shim

62 950 ...

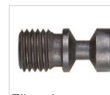

Elbow lever screw

62 950 ...



Lever

62 950 ...



Carbide type C

62 950 ...

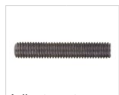

Adjustment screw

62 950 ...

Spare parts

D _{min} - D _{max}	Insert				
65,5 - 87,5	CN.. 1204	096	136	125	117
					M6x20
					242

1 Suitable inserts can be found on → Page 63.

SpinTools – Pair of tool holders, 'Synchro', 90°

Scope of supply:

Insert clamping screws, synchronization screw

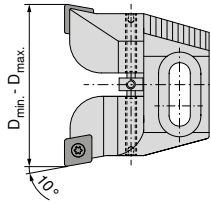

62 297 ...

D _{min} - D _{max} mm	Insert	
23,5 - 30,5	CC.. 0602	030
29,5 - 40,1	CC.. 0602	040
39,5 - 50,5	CC.. 09T3	050
49,5 - 66,5	CC.. 09T3	066
65,5 - 87,5	CC.. 1204	087

5



TORX® Screws

62 950 ...



Synchronization screw

62 950 ...



Key D

80 950 ...

Spare parts for Article no.

62 297 030	M2,5x6	022	M4x0,5x18	207	T07	109
62 297 040	M2,5x6	022	M4x0,5x23	208	T07	109
62 297 050	M4x9	023	M4x0,5x30	209	T15	113
62 297 066	M4x9	023	M6x40	210	T15	113
62 297 087	M5x10	232	M6x52	211	T20	114

Suitable inserts can be found on → Page 63.

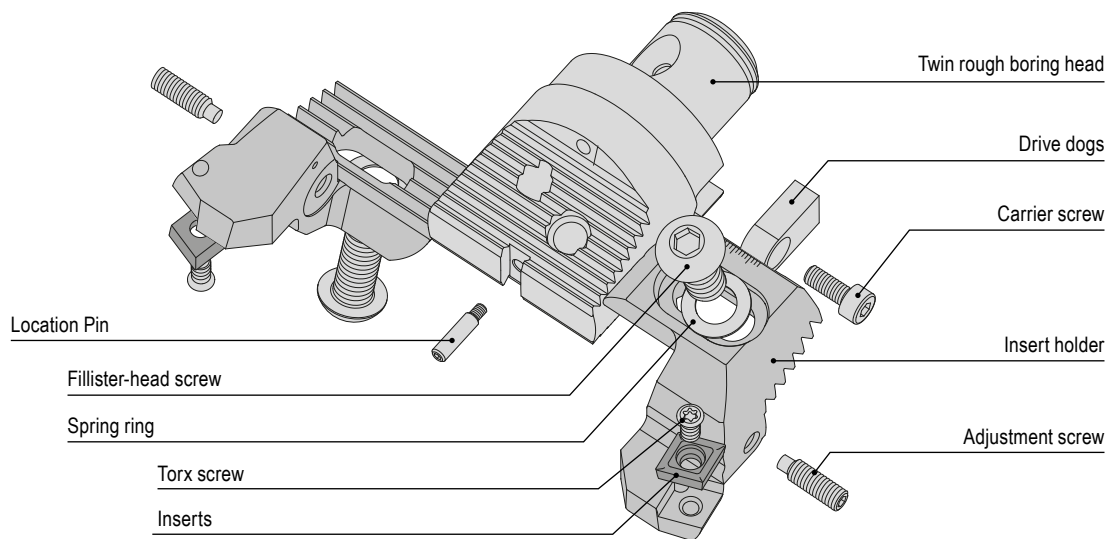

Standard version

SpinTools – Base adapters ISO 7388-1 (DIN 69871)

STM

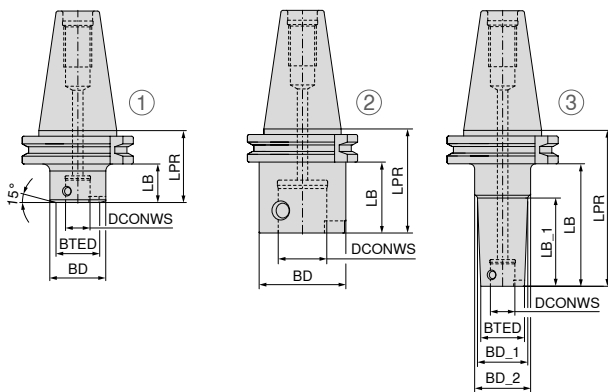

SK
62 107 ...

	Adapter	Fig.	SZID	DCONWS mm	BTED mm	BD mm	BD_1 mm	BD_2 mm	LPR mm	LB mm	LB_1 mm	WT kg	
short	SK 40	1	STM 11	11	20	32			40	20,9		0,91	111 ¹⁾
	SK 40	1	STM 14	14	25	32			40	20,9		0,93	114 ¹⁾
	SK 40	2	STM 18	18		32			40	20,9		0,89	118
	SK 40	2	STM 22	22		40			50	30,9		1,02	122
	SK 40	2	STM 28	28		50			50	30,9		1,11	128
	SK 40	2	STM 36	36		63			60	40,9		1,27	136
	SK 50	2	STM 28	28		50			50	30,9		2,92	428
	SK 50	2	STM 36	36		63			63	43,9		3,27	436
long	SK 40	3	STM 11	11	20		23	32	80	60,9	40,9	1,04	211 ¹⁾
	SK 40	3	STM 14	14	25		28	32	80	60,9	40,9	1,07	214 ¹⁾
	SK 40	2	STM 18	18		32			80	60,9		1,13	218
	SK 40	2	STM 22	22		40			100	80,9		1,47	222
	SK 40	2	STM 28	28		50			100	80,9		1,84	228
	SK 40	2	STM 36	36		63			120	100,9		2,68	236
	SK 50	2	STM 36	36		63			120	100,9		4,60	536

1) Note! BD/BD_1 is larger than BTED, which may lead to a limited bore depth!



O-Ring



Clamping screw
ST

62 950 ...

62 950 ...

Spare parts
DCONWS

11	9x1,5	254	M4x0,5x6	026
14	12x1,5	255	M5x0,5x7,5	027
18	16x1,5	256	M6x0,75x9,5	028
22	19x2	257	M8x0,75x12	029
28	25x2	258	M10x1x14,2	030
36	33x2	259	M12x1x18	031

i Suitable pull studs can be found in → **Clamping technology catalogue, Chapter 16, Adapters and accessories.**

i ABS base adapters can be found in → **Clamping technology catalogue, Chapter 16, Adapters and accessories.**

SpinTools – Base adapters ISO 7388-2 (JIS B 6339 / MAS-BT)

▲ form B available upon request

STM

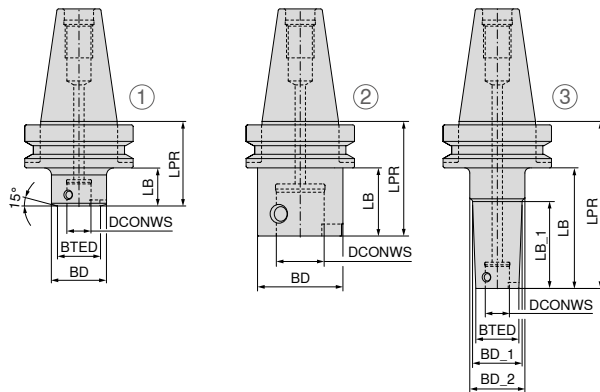

5

MAS-BT
62 112 ...

Adapter	Fig.	SZID	DCONWS	BTED	BD	BD_1	BD_2	LPR	LB	LB_1	WT		
			mm	mm	mm	mm	mm	mm	mm	mm	kg		
short	BT 30	2	STM 28	28		50		55			0,64	328	
	BT 40	1	STM 11	11	20	32		50	23		1,09	111 ¹⁾	
	BT 40	1	STM 14	14	25	32		50	23		1,08	114 ¹⁾	
	BT 40	2	STM 18	18		32		50	23		1,06	118	
	BT 40	2	STM 22	22		40		50	23		1,10	122	
	BT 40	2	STM 28	28		50		50	23		1,14	128	
	BT 40	2	STM 36	36		63		60	33		1,38	136	
long	BT 50	2	STM 28	28		50		63	25		3,75	428	
	BT 50	2	STM 36	36		63		63	25		3,78	436	
	BT 40	3	STM 11	11	20		23	32	90	63	43	1,20	211 ¹⁾
	BT 40	3	STM 14	14	25		28	32	90	63	43	1,24	214 ¹⁾
	BT 40	2	STM 18	18		32		90	63			1,30	218
	BT 40	2	STM 22	22		40		100	73			1,57	222
	BT 40	2	STM 28	28		50		100	73			1,87	228
	BT 40	2	STM 36	36		63		120	93			2,78	236
	BT 50	2	STM 36	36		63			120	82		5,18	536

1) Note! BD/BD_1 is larger than BTED, which may lead to a limited bore depth!

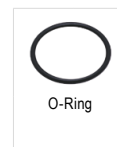

O-Ring



Clamping screw
ST

62 950 ...

62 950 ...

Spare parts
DCONWS

11	9x1,5	254	M4x0,5x6	026
14	12x1,5	255	M5x0,5x7,5	027
18	16x1,5	256	M6x0,75x9,5	028
22	19x2	257	M8x0,75x12	029
28	25x2	258	M10x1x14,2	030
36	33x2	259	M12x1x18	031

Suitable pull studs can be found in → **Clamping technology catalogue, Chapter 16, Adapters and accessories.**

ABS base adapters can be found in → **Clamping technology catalogue, Chapter 16, Adapters and accessories.**

SpinTools – Base adapters HSK-A ISO 12164-1 (DIN 69893-1)

STM

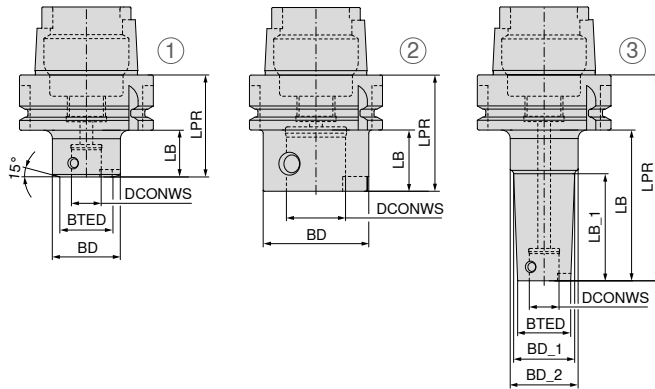

62 122 ...

	Adapter	Fig.	SZID	DCONWS mm	BTED mm	BD mm	BD_1 mm	BD_2 mm	LPR mm	LB mm	LB_1 mm	WT kg	
short	HSK-A 63	1	STM 11	11	20	32			50	24		0,77	111 ¹⁾
	HSK-A 63	1	STM 14	14	25	32			50	24		0,76	114 ¹⁾
	HSK-A 63	2	STM 18	18		32			50	24		0,74	118
	HSK-A 63	2	STM 22	22		40			50	24		0,79	122
	HSK-A 63	2	STM 28	28		50			55	24		0,91	128
	HSK-A 63	2	STM 36	36		63			65	34		1,10	136
	HSK-A 100	2	STM 28	28		50			63	34		2,32	428
	HSK-A 100	2	STM 36	36		63			70	34		2,61	436
long	HSK-A 63	3	STM 11	11	20		23	32	90	64	44	0,87	211 ¹⁾
	HSK-A 63	3	STM 14	14	25		28	32	90	64	44	0,93	214 ¹⁾
	HSK-A 63	2	STM 18	18		32			90	64		0,98	218
	HSK-A 63	2	STM 22	22		40			100	74		1,26	222
	HSK-A 63	2	STM 28	28		50			100	74		1,58	228
	HSK-A 63	2	STM 36	36		63			120	94		2,41	236

1) Note! BD/BD_1 is larger than BTED, which may lead to a limited bore depth!

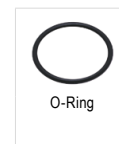

O-Ring



Clamping screw
ST

62 950 ...

62 950 ...

Spare parts

DCONWS				
11		9x1,5	254	M4x0,5x6 026
14		12x1,5	255	M5x0,5x7,5 027
18		16x1,5	256	M6x0,75x9,5 028
22		19x2	257	M8x0,75x12 029
28		25x2	258	M10x1x14,2 030
36		33x2	259	M12x1x18 031

1 ABS base adapters can be found in → **Clamping technology catalogue, Chapter 16, Adapters and accessories.**

SpinTools – Reductions

▲ with thro' coolant

STM

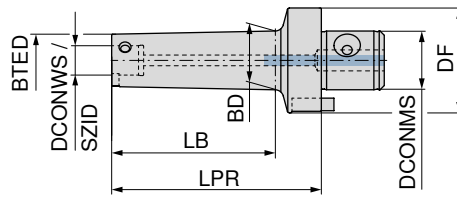

62 357 ...

Adapter	LPR mm	SZID	DCONMS mm	DCONWS mm	DF mm	BTED mm	BD mm	LB mm	WT kg	
STM 14	30	STM 11	14	11	25	20	23	15	0,04	111
STM 18	30	STM 11	18	11	32	20	23	17	0,14	211
STM 18	30	STM 14	18	14	32	25	28	17	0,16	214
STM 22	30	STM 11	22	11	40	20	23	15	0,21	311
STM 22	30	STM 14	22	14	40	25	28	15	0,22	314
STM 22	30	STM 18	22	18	40	32	37	15	0,25	318
STM 28	40	STM 11	28	11	50	20	23	20	0,44	411
STM 28	40	STM 14	28	14	50	25	28	20	0,49	414
STM 28	40	STM 18	28	18	50	32	37	20	0,45	418
STM 28	40	STM 22	28	22	50	40	46	20	0,55	422
STM 36	40	STM 11	36	11	63	20	22	16	0,82	511
STM 36	70	STM 11	36	11	63	20	23	42	0,90	811
STM 36	95	STM 11	36	11	63	20	23	71	0,98	611
STM 36	115	STM 11	36	11	63	20	23	87	1,02	911
STM 36	135	STM 11	36	11	63	20	23	111	1,08	711
STM 36	40	STM 14	36	14	63	25	27	16	0,84	514
STM 36	80	STM 14	36	14	63	25	28	52	1,00	814
STM 36	120	STM 14	36	14	63	25	28	96	1,16	614
STM 36	145	STM 14	36	14	63	25	28	117	1,27	914
STM 36	170	STM 14	36	14	63	25	28	146	1,38	714
STM 36	40	STM 18	36	18	63	32	37	16	0,85	518
STM 36	100	STM 18	36	18	63	32	38	74	1,24	818
STM 36	150	STM 18	36	18	63	32	38	126	1,66	918
STM 36	207	STM 18	36	18	63	32	38	183	2,07	618
STM 36	40	STM 22	36	22	63	40	46	16	0,89	522
STM 36	120	STM 22	36	22	63	40	48	95	1,76	822
STM 36	183	STM 22	36	22	63	40	48	159	2,52	622
STM 36	263	STM 22	36	22	63	40	48	239	3,44	722
STM 36	40	STM 28	36	28	63	50	58	21	1,03	528
STM 36	140	STM 28	36	28	63	50	60	117	2,70	828
STM 36	233	STM 28	36	28	63	50	60	209	4,41	628
STM 36	333	STM 28	36	28	63	50	60	309	6,25	728

ABS reductions can be found in → Clamping technology catalogue, Chapter 16, Adapters and accessories.

Reductions – Spare Parts

		 O-Ring	 Screw for drivers	 Driver	 Clamping screw ST			
		62 950 ...	62 950 ...	62 950 ...	62 950 ...			
Spare parts for Article no.								
62 357 111	9x1,5	254	M2,5x6	163	6x10,3x4	036	M4x0,5x6	026
62 357 211	9x1,5	254	M3x8	164	8x15x5	037	M4x0,5x6	026
62 357 214	12x1,5	255	M3x8	164	8x15x5	037	M5x0,5x7,5	027
62 357 311	9x1,5	254	M4x10	165	10x18,1x6	038	M4x0,5x6	026
62 357 314	12x1,5	255	M4x10	165	10x18,1x6	038	M5x0,5x7,5	027
62 357 318	16x1,5	256	M4x10	165	10x18,1x6	038	M6x0,75x9,5	028
62 357 411	9x1,5	254	M5x10	166	12x20x6	039	M4x0,5x6	026
62 357 414	12x1,5	255	M5x10	166	12x20x6	039	M5x0,5x7,5	027
62 357 418	16x1,5	256	M5x10	166	12x20x6	039	M6x0,75x9,5	028
62 357 422	19x2	257	M5x10	166	12x20x6	039	M8x0,75x12	029
62 357 511	9x1,5	254	M6x12	167	16x26,5x8	040	M4x0,5x6	026
62 357 811	9x1,5	254	M6x12	167	16x26,5x8	040	M4x0,5x6	026
62 357 611	9x1,5	254	M6x12	167	16x26,5x8	040	M4x0,5x6	026
62 357 911	9x1,5	254	M6x12	167	16x26,5x8	040	M4x0,5x6	026
62 357 711	9x1,5	254	M6x12	167	16x26,5x8	040	M4x0,5x6	026
62 357 514	12x1,5	255	M6x12	167	16x26,5x8	040	M5x0,5x7,5	027
62 357 814	12x1,5	255	M6x12	167	16x26,5x8	040	M5x0,5x7,5	027
62 357 614	12x1,5	255	M6x12	167	16x26,5x8	040	M5x0,5x7,5	027
62 357 914	12x1,5	255	M6x12	167	16x26,5x8	040	M5x0,5x7,5	027
62 357 714	12x1,5	255	M6x12	167	16x26,5x8	040	M5x0,5x7,5	027
62 357 518	16x1,5	256	M6x12	167	16x26,5x8	040	M6x0,75x9,5	028
62 357 818	16x1,5	256	M6x12	167	16x26,5x8	040	M6x0,75x9,5	028
62 357 918	16x1,5	256	M6x12	167	16x26,5x8	040	M6x0,75x9,5	028
62 357 618	16x1,5	256	M6x12	167	16x26,5x8	040	M6x0,75x9,5	028
62 357 522	19x2	257	M6x12	167	16x26,5x8	040	M8x0,75x12	029
62 357 822	19x2	257	M6x12	167	16x26,5x8	040	M8x0,75x12	029
62 357 622	19x2	257	M6x12	167	16x26,5x8	040	M8x0,75x12	029
62 357 722	19x2	257	M6x12	167	16x26,5x8	040	M8x0,75x12	029
62 357 528	25x2	258	M6x12	167	16x26,5x8	040	M10x1x14,2	030
62 357 828	25x2	258	M6x12	167	16x26,5x8	040	M10x1x14,2	030
62 357 628	25x2	258	M6x12	167	16x26,5x8	040	M10x1x14,2	030
62 357 728	25x2	258	M6x12	167	16x26,5x8	040	M10x1x14,2	030

SpinTools – Extensions

▲ with thro' coolant

STM

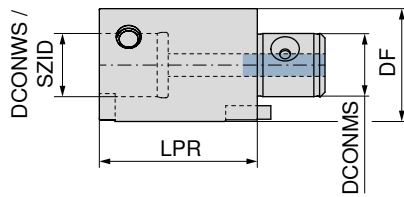

62 351 ...

Adapter	LPR mm	SZID	DCONWS mm	DF mm	DCONMS mm	WT kg	
STM 11	25	STM 11	11	20	11	0,06	111
STM 11	35	STM 11	11	20	11	0,09	211
STM 14	30	STM 14	14	25	14	0,11	114
STM 14	45	STM 14	14	25	14	0,17	214
STM 18	40	STM 18	18	32	18	0,23	118
STM 18	60	STM 18	18	32	18	0,35	218
STM 22	50	STM 22	22	40	22	0,45	122
STM 22	80	STM 22	22	40	22	0,73	222
STM 28	50	STM 28	28	50	28	0,71	128
STM 28	75	STM 28	28	50	28	1,07	228
STM 28	100	STM 28	28	50	28	1,44	328
STM 36	60	STM 36	36	63	36	1,33	136
STM 36	90	STM 36	36	63	36	2,02	236
STM 36	120	STM 36	36	63	36	2,72	336

5

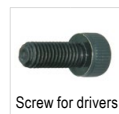

62 950 ...

62 950 ...

62 950 ...

62 950 ...

Spare parts
DCONWS

11	9x1,5	254	M2x2,5	162	5x8,5x3	035	M4x0,5x6	026
14	12x1,5	255	M2,5x6	163	6x10,3x4	036	M5x0,5x7,5	027
18	16x1,5	256	M3x8	164	8x15x5	037	M6x0,75x9,5	028
22	19x2	257	M4x10	165	10x18,1x6	038	M8x0,75x12	029
28	25x2	258	M5x10	166	12x20x6	039	M10x1x14,2	030
36	33x2	259	M6x12	167	16x26,5x8	040	M12x1x18	031

ABS extensions can be found in → **Clamping technology catalogue, Chapter 16, Adapters and accessories.**

SpinTools – ABS/STM adapters

- ▲ using this adapter, ABS core drilling and precision spindle systems can be accommodated reliably and precisely in STM base adapters
- ▲ with thro' coolant supply

STM

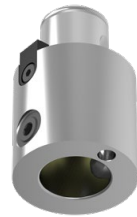
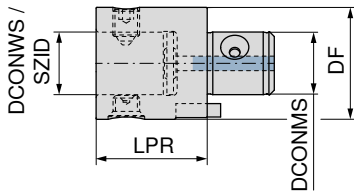

NEW

62 359 ...

Adapter	LPR mm	SZID	DCONWS mm	DF mm	DCONMS mm	
STM 14	35	ABS 25	13	25	14	02519
STM 18	40	ABS 32	16	32	18	03218
STM 22	45	ABS 40	20	40	22	04017
STM 28	50	ABS 50	28	50	28	05016
STM 36	60	ABS 63	34	63	36	06315

MicroKom – STM/ABS adapters

- ▲ using this adapter, STM core drilling and precision spindle systems can be accommodated reliably and precisely in ABS base adapters
- ▲ with thro' coolant supply

ABS

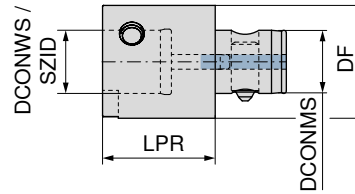

NEW

62 359 ...

Adapter	LPR mm	SZID	DCONWS mm	DF mm	DCONMS mm	
ABS 25	30	STM 14	14	25	13	02590
ABS 32	40	STM 18	18	32	16	03289
ABS 40	40	STM 22	22	40	20	04088
ABS 50	50	STM 28	28	50	28	05097
ABS 63	60	STM 36	36	63	34	06396



Clamping screw



Driver

62 950 ...

62 950 ...

Spare parts
DCONWS

13		036
16	13989	037
20		038
28		039
34		040



Clamping screw
ST

62 950 ...

Spare parts
DCONWS

14		027
18		028
22		029
28		030
36		031

WOHX

Designation	L mm	S mm	D1 mm	IC mm
WOHX 02T0..	2,6	1,20	2	4

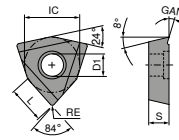

WOHX

-G12 BK2710	-G12 BK8440	-G12 K10
F WOHX	F WOHX	F WOHX
62 600 ...	62 600 ...	62 600 ...
10102	00102	20102

ISO	KOMET no.	RE mm
02T001EL	W00 04120.018440	0,1
02T001EL	W00 04120.012710	0,1
02T001FL	W00 04120.0121	0,1

P	•	•	
M	•	•	
K	•	•	
N			•
S	•		•
H		•	
O			•

→ v_c Page 65

Material group	Guideline recommendation	
	Grade	Chip groove
P	BK8440	-G12
M	BK8440	-G12
K	BK2710	-G12
N	K10	-G12
S	K10	-G12
H1.1	BK8440	-G12
O	K10	-G12

The guideline recommendation shown here is based on experience and serves only to make it easy to find the correct indexable insert for your application.

Additional indexable inserts can be found in our online shop at cuttingtools.ceratizit.com

TOGX

Designation	L mm	S mm	D1 mm	IC mm
TOGX 06T1..	6,64	1,80	2,2	4,0
TOGX 0902..	9,12	2,50	2,8	5,6
TOGX 1403..	13,62	3,00	3,8	8,2

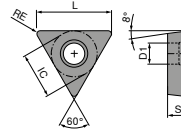

TOGX

-18 CK32	-14 CK3230	-14 BK60	-14 BK8430	-12 BK7710	-12 K10
F	F	F	F	F	F
CERMET TOGX	CERMET TOGX	TOGX	TOGX	TOGX	TOGX

ISO	KOMET no.	RE mm	62 607 ...	62 606 ...	62 601 ...	62 601 ...	62 601 ...	62 601 ...	62 601 ...
06T102EN	W57 04140.0260	0,2			90206				
06T102EN	W57 04140.028430	0,2					30201		
06T102EN	W57 04140.023230	0,2		10201					
06T102EN	W57 04180.0432	0,4	20401						
06T102FN	W57 04120.027710	0,2						70201	
06T102FN	W57 04120.0223	0,2							50206
090202EN	W57 14140.028430	0,2					33801		
090204EN	W57 14140.0460	0,4			70409				
090204EN	W57 14140.043230	0,4		11401					
090204EN	W57 14180.0432	0,4	21401						
090204FN	W57 14120.047710	0,4						70401	
090204FN	W57 14120.0423	0,4							50409
140302EN	W57 26140.028430	0,2					34401		
140304EN	W57 26140.0460	0,4			70414				
140304EN	W57 26140.043230	0,4		12601					
140304EN	W57 26180.0432	0,4	22601						
140304FN	W57 26120.047710	0,4						71401	
140304FN	W57 26120.0423	0,4							50414

P	●	●	●	○					
M	●	●	●	○					
K			●	○					
N								●	●
S							●	○	●
H							●	○	
O								○	●

→ v_c Page 65

TOGX / TOEX / TOHX

Designation	L mm	S mm	D1 mm	IC mm	LE mm
TO.X 06T1..	6,64	1,80	2,2	4,0	1,8
TO.X 0902..	9,12	2,50	2,8	5,6	2,7
TO.X 1403..	13,62	3,00	3,8	8,2	2,7
TOHX 06T1..	6,50	1,80	2,2	4,0	1,0
TOHX 0902..	9,12	2,50	2,8	5,6	2,5
TOHX 1403..	13,62	3,00	3,8	8,2	4,5

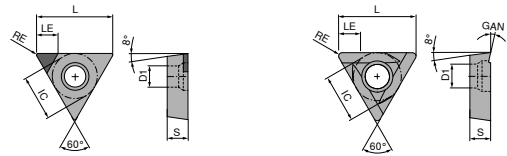

TOGX / TOEX / TOHX

ISO	KOMET no.	RE mm	CBN40		CTDPU20		-G12 BK8425		-G06 BK2710		-G06 BK6110		-G06 BK7615	
			TOGX	TOEX	TOHX	TOHX	TOHX	TOHX	TOHX					
			62 601 ...	62 605 ...	62 603 ...	62 602 ...	62 602 ...	62 602 ...	62 602 ...					
06T102FN	W30 04990.025510	0,2		00201										
06T102TN	W30 04990.0240	0,2	60206											
06T103EL	W30 04120.038425	0,3			30200									
06T103EL	W30 04060.037615	0,3												
06T103EL	W30 04060.036110	0,3								40606			80606	
06T103EL	W30 04060.032710	0,3						10606						
090204EL	W30 14120.048425	0,4			31800									
090204EL	W30 14060.047615	0,4												
090204EL	W30 14060.046110	0,4								40409			80409	
090204EL	W30 14060.042710	0,4						10409						
090204FN	W30 14990.045510	0,4		01401										
090204TN	W30 14990.0440	0,4	60409											
140304EL	W30 26120.048425	0,4			32600									
140304EL	W30 26060.047615	0,4												
140304EL	W30 26060.046110	0,4												
140304EL	W30 26060.042710	0,4						12600		40414			82600	
140304FN	W30 26990.045510	0,4		02601										
140304TN	W30 26990.0440	0,4	62600											
P					●	●	●	●	●	●	●	●	●	●
M					●	●	●	●	●	●	●	●	●	●
K					●	●	●	●	●	●	●	●	●	●
N				●	○	○	○	○	○	○	○	○	○	○
S					●	●	●	●	●	●	●	●	●	●
H			●		○	○	○	○	○	○	○	○	○	○
O				●										

→ v_c Page 65

Material group	Guideline recommendation	
	Grade	Chip groove
P	BK60	-14
M	BK2710	-G06
K	BK7615	-G06
N	BK7710	-12
S1.1 – S2.3	BK2710	-G06
S3.1 – S3.3	BK7710	-12
H	CBN40	
O	BK7710	-12

The guideline recommendation shown here is based on experience and serves only to make it easy to find the correct indexable insert for your application.

Additional indexable inserts can be found in our online shop at cuttingtools.ceratzit.com

WOEX / WOGX

Designation	L mm	S mm	D1 mm	IC mm
WO.X 0302..	3,2	2,30	2,30	5,00
WO.X 0403..	4,1	3,18	2,55	6,35
WO.X 05T3..	5,3	3,80	2,85	8,00
WO.X 06T3..	6,6	3,80	4,05	10,00
WO.X 0804..	7,9	4,80	4,90	12,00
WOEX 1005..	9,9	5,30	4,90	15,00
WOEX 1206..	11,6	6,00	6,00	17,60

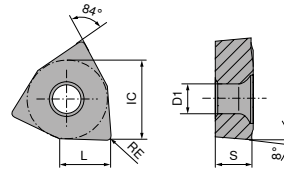





WOEX

	-01 BK8425	-01 BK7935	-01 BK7615	-11 BK77
	WOEX	WOEX	WOEX	WOEX
	10 821 ...	10 821 ...	10 821 ...	10 821 ...
ISO				
KOMET no.				
RE mm				
030204	W29 10010.047935	0,4		
030204	W29 10110.0477	0,4		
030204	W29 10010.047615	0,4		
030204	W29 10010.048425	0,4		
040304	W29 18010.047935	0,4		
040304	W29 18110.0477	0,4		
040304	W29 18010.047615	0,4		
040304	W29 18010.048425	0,4		
05T304	W29 24010.047935	0,4		
05T304	W29 24110.0477	0,4		
05T304	W29 24010.047615	0,4		
05T304	W29 24010.048425	0,4		
06T304	W29 34010.047935	0,4		
06T304	W29 34110.0477	0,4		
06T304	W29 34010.047615	0,4		
06T304	W29 34010.048425	0,4		
080404	W29 42010.047935	0,4		
080404	W29 42110.0477	0,4		
080404	W29 42010.047615	0,4		
080404	W29 42010.048425	0,4		
100504	W29 50010.047935	0,4		
100504	W29 50110.0477	0,4		
100504	W29 50010.047615	0,4		
100504	W29 50010.048425	0,4		
120608	W29 58010.087935	0,8		
120608	W29 58010.087615	0,8		
120608	W29 58010.088425	0,8		
P	●	●		
M	●	●		
K	●	●	●	
N	○	○		
S	●	●		●
H	○			○
O				○

→ v. Page 65

WOEX / WOGX

ISO	KOMET no.	RE mm	<div style="display: flex; justify-content: space-around;"> <div style="text-align: center;"> <div style="border: 1px solid black; padding: 2px;">-01 BK6115</div>  <p>WOEX</p> </div> <div style="text-align: center;"> <div style="border: 1px solid black; padding: 2px;">-02 BK6440</div>  <p>WOEX</p> </div> <div style="text-align: center;"> <div style="border: 1px solid black; padding: 2px;">-15 BK8430</div>  <p>WOGX</p> </div> <div style="text-align: center;"> <div style="border: 1px solid black; padding: 2px; color: white; background-color: red;">NEW</div> <div style="border: 1px solid black; padding: 2px;">-11 BK7710</div>  <p>WOEX</p> </div> </div>				
			10 821 ...	10 821 ...	10 821 ...	10 821 ...	
030204	W29 10150.048430	0,4				00315	
030204	W29 10110.047710	0,4					90311
030204	W29 10010.046115	0,4	40301				
040304	W29 18150.048430	0,4				00415	
040304	W29 18110.047710	0,4					90411
040304	W29 18010.046115	0,4	40401				
05T304	W29 24020.046440	0,4		25502			
05T304	W29 24110.047710	0,4				00515	90511
05T304	W29 24150.048430	0,4					
05T304	W29 24010.046115	0,4	40501				
06T304	W29 34020.046440	0,4		25602			
06T304	W29 34110.047710	0,4					90611
06T304	W29 34150.048430	0,4				00615	
06T304	W29 34010.046115	0,4	40601				
080404	W29 42020.046440	0,4		25802			
080404	W29 42110.047710	0,4					90811
080404	W29 42150.048430	0,4				00815	
080404	W29 42010.046115	0,4	40801				
100504	W29 50020.046440	0,4		26002			
100504	W29 50110.047710	0,4					91011
100504	W29 50010.046115	0,4	41001				
120608	W29 58020.086440	0,8		21202			
120608	W29 58010.086115	0,8	41201				
P			●	●		○	
M			●	●		○	
K			●			○	
N							●
S						●	○
H			○			●	○
O							○

→ v_c Page 65

Material group	Guideline recommendation
	Grade / chip breaker
P	BK8425 / -01
M	BK7935 / -01
K	BK7615 / -01
N	BK7710 / -11
S1.1 – S2.3	BK7935 / -01
S3.1 – S3.3	BK7710 / -11
O	BK7710 / -11

Material group	Maximum feed values						
	WO.X 0302	WO.X 0403	WO.X 05T3	WO.X 06T3	WO.X 0804	WO.X 1005	WO.X 1206
	a _p max.						
P	1,5	2,5	4,5	6,0	7,5	9,0	9,0
M	1,0	1,5	3,5	4,0	6,0	9,0	9,0
K	1,5	3,0	5,0	6,0	7,5	9,0	9,0
N	2,0	3,0	5,0	6,0	7,5	9,0	9,0
S	1,0	1,5	3,5	4,0	6,0	9,0	9,0
O	1,0	1,5	3,5	4,0	7,5	9,0	9,0

The guideline recommendation shown here is based on experience and serves only to make it easy to find the correct indexable insert for your application.

 Additional indexable inserts can be found in our online shop at cuttingtools.ceratizit.com

WCMT / WCGT

Designation	L mm	S mm	D1 mm	IC mm
WCGT 0201..	2,71	1,59	2,1	3,97
WCMT 0201..	2,71	1,59	2,1	3,97

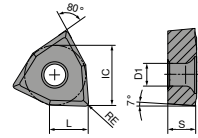

WCMT / WCGT

	-SF30 CWC06	-SF20 CWN10	-SF16 CWP25
	F	F	F
	CERMET WCMT	WCGT	WCGT
	70 294 ...	70 295 ...	70 295 ...
	850	850 852	500

ISO	RE mm
020102	0,2
020104	0,4

P	●	●	●
M	○	●	●
K	●	●	○
N	●	●	●
S		●	●
H		●	
O			

→ v_c Page 66

Additional indexable inserts can be found in → **Chapter 9, Indexable insert turning tools**
or in our online shop at cuttingtools.ceratizit.com

CCGT

Designation	L mm	S mm	D1 mm	IC mm
CCGT 06..	6,4	2,38	2,8	6,35
CCGT 09..	9,7	3,97	4,4	9,52

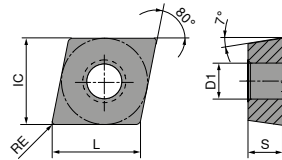

CCGT

-SF20 CWN10	-SF15 CWC06	-SF14 CWC10
F	F	F
CCGT	CERMET CCGT	CERMET CCGT
70 296 ...	70 296 ...	70 300 ...
300	850	903
302	852	905
304	854	911
306	856	913

ISO	RE mm
060202L	0,2
060204L	0,4
09T302L	0,2
09T304L	0,4

P	●	●	●
M	●	○	●
K	●	●	●
N	●	●	●
S	●	●	●
H	●	●	●
O	●	●	●

→ v_c Page 66

Additional indexable inserts can be found in → **Chapter 9, Indexable insert turning tools**
or in our online shop at cuttingtools.ceratizit.com

Material examples for cutting data tables

	Material sub-group	Index	Composition / Structure / Heat treatment	Tensile strength N/mm ² / HB / HRC	Material number	Material designation	Material number	Material designation	
P	Unalloyed steel	P.1.1	< 0,15 % C Annealed	420 N/mm ² / 125 HB	1.0401	C15	1.1141	Ck15	
		P.1.2	< 0,45 % C Annealed	640 N/mm ² / 190 HB	1.1191	C45E	1.0718	9SMnPb28	
		P.1.3	< 0,45 % C Tempered	840 N/mm ² / 250 HB	1.1191	C45E	1.0535	C55	
		P.1.4	< 0,75 % C Annealed	910 N/mm ² / 270 HB	1.1223	C60R	1.0535	C55	
		P.1.5	< 0,75 % C Tempered	1010 N/mm ² / 300 HB	1.1223	C60R	1.0727	45S20	
	Low-alloy steel	P.2.1	Annealed	610 N/mm ² / 180 HB	1.7131	16MnCr5	1.6587	17CrNiMo6	
		P.2.2	Tempered	930 N/mm ² / 275 HB	1.7131	16MnCr5	1.6587	17CrNiMo6	
		P.2.3	Tempered	1010 N/mm ² / 300 HB	1.7225	42CrMo4	1.3505	100Cr6	
		P.2.4	Tempered	1200 N/mm ² / 375 HB	1.7225	42CrMo4	1.3505	100Cr6	
	High-alloy steel and high-alloy tool steel	P.3.1	Annealed	680 N/mm ² / 200 HB	1.4021	X20Cr13	1.4034	X46Cr13	
		P.3.2	Hardened and tempered	1100 N/mm ² / 300 HB	1.2343	X38CrMoV5-1	1.4034	X46Cr13	
		P.3.3	Hardened and tempered	1300 N/mm ² / 400 HB	1.2343	X38CrMoV5-1	1.4034	X46Cr13	
	Stainless steel	P.4.1	Ferritic / martensitic Annealed	680 N/mm ² / 200 HB	1.4016	X6Cr17	1.2316	X36CrMo16	
		P.4.2	Martensitic Tempered	1010 N/mm ² / 300 HB	1.4112	X90CrMoV18	1.2316	X36CrMo16	
M	Stainless steel	M.1.1	Austenitic / austenitic-ferritic Quenched	610 N/mm ² / 180 HB	1.4301	X5CrNi18-10	1.4571	X6CrNiMoTi17-12-2	
		M.2.1	Austenitic Tempered	300 HB	1.4841	X15CrNiSi25-21	1.4539	X1NiCrMoCu25-20-5	
		M.3.1	Austenitic / ferritic (Duplex)	780 N/mm ² / 230 HB	1.4462	X2CrNiMoN22-5-3	1.4501	X2CrNiMoCuWN25-7-4	
K	Grey cast iron	K.1.1	Pearlitic / ferritic	350 N/mm ² / 180 HB	0.6010	GG-10	0.6025	GG-25	
		K.1.2	Pearlitic (martensitic)	500 N/mm ² / 260 HB	0.6030	GG-30	0.6045	GG-45	
	Spherulitic graphite cast iron	K.2.1	Ferritic	540 N/mm ² / 160 HB	0.7040	GGG-40	0.7060	GGG-60	
		K.2.2	Pearlitic	845 N/mm ² / 250 HB	0.7070	GGG-70	0.7080	GGG-80	
	Malleable iron	K.3.1	Ferritic	440 N/mm ² / 130 HB	0.8035	GTW-35-04	0.8045	GTW-45	
		K.3.2	Pearlitic	780 N/mm ² / 230 HB	0.8165	GTS-65-02	0.8170	GTS-70-02	
N	Aluminium wrought alloy	N.1.1	Non-hardenable	60 HB	3.0255	Al99,5	3.3315	AlMg1	
		N.1.2	Hardenable Age-hardened	340 N/mm ² / 100 HB	3.1355	AlCuMg2	3.2315	AlMgSi1	
	Cast aluminium alloy	N.2.1	≤ 12 % Si, non-hardenable	250 N/mm ² / 75 HB	3.2581	G-AlSi12	3.2163	G-AlSi9Cu3	
		N.2.2	≤ 12 % Si, hardenable Age-hardened	300 N/mm ² / 90 HB	3.2134	G-AlSi5Cu1Mg	3.2373	G-AlSi9Mg	
		N.2.3	> 12 % Si, non-hardenable	440 N/mm ² / 130 HB		G-AlSi17Cu4Mg		G-AlSi18CuNiMg	
	Copper and copper alloys (bronze/brass)	N.3.1	Free-machining alloys, PB > 1 %	375 N/mm ² / 110 HB	2.0380	CuZn39Pb2 (Ms58)	2.0410	CuZn44Pb2	
		N.3.2	CuZn, CuSnZn	300 N/mm ² / 90 HB	2.0331	CuZn15	2.4070	CuZn28Sn1As	
		N.3.3	CuSn, lead-free copper and electrolytic copper	340 N/mm ² / 100 HB	2.0060	E-Cu57	2.0590	CuZn40Fe	
	Magnesium alloys	N.4.1	Magnesium and magnesium alloys	70 HB	3.5612	MgAl6Zn	3.5312	MgAl3Zn	
	S	Heat-resistant alloys	S.1.1	Fe - basis Annealed	680 N/mm ² / 200 HB	1.4864	X12NiCrSi 36-16	1.4865	G-X40NiCrSi38-18
S.1.2			Age-hardened		950 N/mm ² / 280 HB	1.4980	X6NiCrTiMoVB25-15-2	1.4876	X10NiCrAlTi32-20
S.2.1			Ni or Co basis Annealed	840 N/mm ² / 250 HB	2.4631	NiCr20TiAl (Nimonic80A)	3.4856	NiCr22Mo9Nb	
S.2.2				Age-hardened	1180 N/mm ² / 350 HB	2.4668	NiCr19Nb5Mo3 (Inconel 718)	2.4955	NiFe25Cr20NbTi
S.2.3				Cast	1080 N/mm ² / 320 HB	2.4765	CoCr20W15Ni	1.3401	G-X120Mn12
Titanium alloys		S.3.1	Pure titanium	400 N/mm ²	3.7025	Ti99,8	3.7034	Ti99,7	
		S.3.2	Alpha + beta alloys Age-hardened	1050 N/mm ² / 320 HB	3.7165	TiAl6V4	Ti-6246	Ti-6Al-2Sn-4Zr-6Mo	
S.3.3	Beta alloys	1400 N/mm ² / 410 HB	Ti555.3	Ti-5Al-5V-5Mo-3Cr	R56410	Ti-10V-2Fe-3Al			
H	Hardened steel	H.1.1	Hardened and tempered	46–55 HRC					
		H.1.2	Hardened and tempered	56–60 HRC					
		H.1.3	Hardened and tempered	61–65 HRC					
		H.1.4	Hardened and tempered	66–70 HRC					
	Chilled iron	H.2.1	Cast	400 HB					
Hardened cast iron	H.3.1	Hardened and tempered	55 HRC						
O	Non-metal materials	O.1.1	Plastics, duroplastic	≤ 150 N/mm ²					
		O.1.2	Plastics, thermoplastic	≤ 100 N/mm ²					
		O.2.1	Aramid fibre-reinforced	≤ 1000 N/mm ²					
		O.2.2	Glass/carbon-fibre reinforced	≤ 1000 N/mm ²					
		O.3.1	Graphite						

* Tensile strength

Cutting data standard values for indexable inserts – MicroKom tools

Index	Indexable inserts for ...																			
	MicroKom												TwinKom							
	62 800 ..., 62 810 ..., 62 815 ..., 62 820 ..., 62 840 ...												62 870 ...							
	K10	BK 2710	BK 60	BK 6110	BK 7615	BK 7710	BK 8425	BK 8430	BK 8440	CBN 40	CTDPU 20	CK 3230	CK 32	BK 6115	BK 6440	BK 7615	BK 77	BK 7710	BK 7935	BK 8425
v _c (m/min)												v _c (m/min)								
P.1.1		230	270	300			260	200	170			350	350	300	240			250	260	200
P.1.2		230	270	300			260	200	170			350	350	300	240			220	260	200
P.1.3		230	270	300			270	200	170			350	350	270	220			270	270	200
P.1.4		210	250	300			240	180	150			320	320	250	220			240	240	180
P.1.5		210	250	300			230	180	150			320	320	270	220			200	230	180
P.2.1		180	210	270			270	160	140			280	280	270	200			270	270	160
P.2.2		180	210	270			260	160	140			280	280	260	200			260	260	160
P.2.3		180	210	270			180	160	140			280	280	240	200			160	180	160
P.2.4		180	210	270			150	160	140			280	280	190	200			130	150	160
P.3.1		160	190	250			160	140	120			250	250	200	180			140	160	140
P.3.2		160	190	250			130	140	120			250	250	160	160			110	130	140
P.3.3		160	190	250			120	140	120			250	250	140	160			100	120	140
P.4.1		140	160	220			180	120	100			210	210	220	140			160	180	120
P.4.2		140	160	220			130	120	100			210	210	160	140			110	130	120
M.1.1		180	280	220			150	160	140			280	280	220	200			160	150	160
M.2.1		160	250	220			150	140	120			250	250	220	180			160	150	140
M.3.1		120	180	200			130	100	90			180	180	200	160			150	130	100
K.1.1		210	210	290	290		160	180	150					240		290		150	160	180
K.1.2		180	180	290	290		120	160	140					140		290		110	120	160
K.2.1		160	160	270	270		160	140	120					160		270		150	160	140
K.2.2		160	160	250	250		100	140	120					100		250		90	100	140
K.3.1		140	140	220	220		120	120	100					120		220		110	120	120
K.3.2		140	140	220	220		100	120	100					100		220		90	100	120
N.1.1	250					600	400					500					600	400	400	
N.1.2	250					500	400					500					500	400	400	
N.2.1	250					400	250					500					400	250	250	
N.2.2	250					300	250					500					300	250	250	
N.2.3	250					250	230					500					250	230	230	
N.3.1	230					400	200					450					400	200	200	
N.3.2	230					300	220					450					300	220	220	
N.3.3	230					300	330					450					300	330	330	
N.4.1	230					300	200					450					300	200	200	
S.1.1	20	60				60	60	60								50	60	50	60	60
S.1.2	20	50				60	50	50								40	60	40	50	50
S.2.1	20	60				60	60	60								50	60	50	60	60
S.2.2	20	50				60	50	50								40	60	40	50	50
S.2.3	20	30				60	30	30								30	60	30	30	30
S.3.1	60	100				80	100	100								70	80	70	100	100
S.3.2	30	80				80	80	80								60	80	60	80	80
S.3.3	30	50				80	50	50								40	80	40	50	50
H.1.1				100		80	100	100	90	160				100		40	80		100	100
H.1.2				80		40	80	80	70	185				80		30	40		80	80
H.1.3				50		40	50	50	40	215				50		20	40		50	50
H.1.4						40				240							40			
H.2.1				100		80	100	100	90					100		40	80		100	100
H.3.1				80		80	80	80	70					80		30	80		80	80
O.1.1	100					100						500				100	100			
O.1.2	100					100						500				100	100			
O.2.1												500								
O.2.2	100					100						300				100	100			
O.3.1	100					100						300				100	100			

5

 The cutting data is significantly dependent on the external conditions, e.g. stability of the tool and workpiece clamping, material and machine type! The stated values are possible cutting data which have to be increased or reduced according to the application conditions! The specified values represent guideline cutting data that can be adjusted by approx. ± 20 % according to the usage conditions. It is essential to observe the v_c values of the type used (page 65+66), the maximum speeds of the system and the reduction of these maximum speeds depending on the type used overhang length. You can find these on pages 72+74.

Cutting data standard values for indexable inserts – SpinTools tools

Index	Indexable inserts for ...									Boring steel	Inserts Cutting insert
	62 295 ...					62 303 ..., 62 304 ..., 62 305 ..., 62 308 ..., 62 326 ..., 62 332 ..., 62 333 ..., 62 363 ..., 62 372 ..., 62 373 ...				62 346 ...	62 383 ..., 62 384 ...
	CTCP125 (HCX1125)	CTCP115 (HCX1115)	CTCP135 (HCR1135)	CTC2135 (CWN2135)	H10T (CWK15)	CWN10	CWP25	CWC06	CWC10	HM uncoated	Solid carbide TiN
	v _c (m/min)					v _c (m/min)				v _c (m/min)	v _c (m/min)
P.1.1	295	370	210	360		185	185	250	175	175	190
P.1.2	250	315	175	360		185	185	250	140	175	200
P.1.3	210	270	145	360		185	185	250	140	175	170
P.1.4	200	250	135	375		185	185	250	140	175	170
P.1.5	180	230	120	375		185	185	250	140	175	160
P.2.1	260	325	180	385		185	185	250	140	175	180
P.2.2	195	250	130	385		185	185	250	175	175	150
P.2.3	180	230	120	385		185	185	250	140	175	160
P.2.4	130	170	85	385		185	185	250	140	175	160
P.3.1	170	200	150	310		185	185	250	175	175	120
P.3.2	105	140	95	310		135	135	165	140	65	100
P.3.3	40	85	35	310		135	135	165	140	65	100
P.4.1	170	200	155	320		125	125	120	120	100	80
P.4.2	135	170	125	320		125	125	120	120	100	80
M.1.1			155	300		120	120	120	120	100	80
M.2.1			95	310		100	100	100	110	70	80
M.3.1			135	325		120	120	120	120	100	80
K.1.1	170	255			140	160	160	160	225	135	200
K.1.2	160	235			115	160	160	160	225	135	150
K.2.1	180	270			150	160	160	160	125	135	120
K.2.2	160	205			110	140	140	140	125	115	110
K.3.1	200	250			170	140	140	140	125	115	180
K.3.2	160	210			140	140	140	140	125	115	150
N.1.1					1400	400	400	400		250	300
N.1.2					1100	400	400	400		250	240
N.2.1					950	400	400	400		250	240
N.2.2					950	400	400	400		250	240
N.2.3					500	400	400	400		250	240
N.3.1					425	400	400	400		250	290
N.3.2					400	400	400	400		250	290
N.3.3					275	400	400	400		250	290
N.4.1					225						220
S.1.1				30		55					60
S.1.2				25		55					40
S.2.1				15		55					30
S.2.2				10		55					30
S.2.3				10		55					30
S.3.1				105		55					30
S.3.2				25		55					25
S.3.3						55					25
H.1.1						125					110
H.1.2						100					80
H.1.3						80					70
H.1.4											
H.2.1						170					70
H.3.1						125					70
O.1.1					130						240
O.1.2											240
O.2.1					105						180
O.2.2											180
O.3.1											180

 The cutting data is significantly dependent on the external conditions, e.g. stability of the tool and workpiece clamping, material and machine type! The stated values are possible cutting data which have to be increased or reduced according to the application conditions! The specified values represent guideline cutting data that can be adjusted by approx. ± 20 % according to the usage conditions. It is essential to observe the v_c values of the type used (page 65+66), the maximum speeds of the system and the reduction of these maximum speeds depending on the type used overhang length. You can find these on pages 72+74.

Cutting data standard values for precision adjustment heads – MicroKom

Index	62 820 ..., 62 840 ..., 62 800 ...				62 800 06089			● 1st choice		
	BluFlex 2, hi.flex				hi.flex micro			○ suitable		
	Fine machining with depth of cut $a_p = 0.1 - 0.2$ mm				Fine machining with depth of cut $a_p = 0.1 - 0.2$ mm			Emulsion	Compressed air	MMS
	Ø 0,5 – 5,6	Ø 5,6 – 8	Ø 8 – 12	Ø 12 – 365	Ø 0,5 – 8	Ø 8 – 12	Ø 12 – 60			
	f (mm/rev)				f (mm/rev)					
P.1.1	0,02–0,05	0,03–0,04	0,05–0,07	0,07–0,10	0,02–0,05	0,05–0,07	0,07–0,10	●	○	
P.1.2	0,02–0,05	0,03–0,04	0,05–0,07	0,08–0,12	0,02–0,05	0,05–0,07	0,08–0,12	●	○	
P.1.3	0,02–0,05	0,03–0,04	0,04–0,06	0,08–0,12	0,02–0,05	0,04–0,06	0,08–0,12	●	○	
P.1.4	0,02–0,05	0,03–0,04	0,04–0,06	0,07–0,10	0,02–0,05	0,04–0,06	0,07–0,10	●	○	
P.1.5	0,02–0,05	0,03–0,04	0,05–0,07	0,08–0,12	0,02–0,05	0,05–0,07	0,08–0,12	●	○	
P.2.1	0,02–0,05	0,03–0,04	0,04–0,06	0,08–0,12	0,02–0,05	0,04–0,06	0,08–0,12	●	○	
P.2.2	0,02–0,05	0,03–0,04	0,04–0,06	0,07–0,10	0,02–0,05	0,04–0,06	0,07–0,10	●	○	
P.2.3	0,02–0,05	0,02–0,03	0,04–0,06	0,07–0,10	0,02–0,05	0,04–0,06	0,07–0,10	●	○	
P.2.4	0,02–0,05	0,02–0,03	0,03–0,04	0,06–0,08	0,02–0,05	0,03–0,04	0,06–0,08	●	○	
P.3.1	0,02–0,05	0,02–0,03	0,04–0,06	0,06–0,08	0,02–0,05	0,04–0,06	0,06–0,08	●	○	
P.3.2	0,02–0,05	0,02–0,03	0,03–0,04	0,06–0,08	0,02–0,05	0,03–0,04	0,06–0,08	●	○	
P.3.3	0,02–0,05	0,02–0,03	0,03–0,04	0,06–0,08	0,02–0,05	0,03–0,04	0,06–0,08	●	○	
P.4.1	0,02–0,05	0,02–0,03	0,04–0,05	0,07–0,10	0,02–0,05	0,04–0,05	0,07–0,10	●	○	
P.4.2	0,02–0,05	0,02–0,03	0,03–0,04	0,06–0,08	0,02–0,05	0,03–0,04	0,06–0,08	●	○	
M.1.1	0,02–0,05	0,01–0,015	0,04–0,05	0,07–0,10	0,02–0,05	0,04–0,05	0,07–0,10	●	○	
M.2.1	0,02–0,05	0,01–0,015	0,03–0,04	0,06–0,08	0,02–0,05	0,03–0,04	0,06–0,08	●	○	
M.3.1	0,02–0,05	0,01–0,015	0,03–0,04	0,06–0,08	0,02–0,05	0,03–0,04	0,06–0,08	●	○	
K.1.1	0,02–0,05	0,04–0,05	0,06–0,08	0,11–0,15	0,02–0,05	0,06–0,08	0,11–0,15	○	●	
K.1.2	0,02–0,05	0,04–0,05	0,06–0,08	0,11–0,15	0,02–0,05	0,06–0,08	0,11–0,15	○	●	
K.2.1	0,02–0,05	0,03–0,04	0,06–0,08	0,11–0,15	0,02–0,05	0,06–0,08	0,11–0,15	○	●	
K.2.2	0,02–0,05	0,02–0,03	0,05–0,07	0,08–0,12	0,02–0,05	0,05–0,07	0,08–0,12	○	●	
K.3.1	0,02–0,05	0,03–0,04	0,06–0,08	0,11–0,15	0,02–0,05	0,06–0,08	0,11–0,15	○	●	
K.3.2	0,02–0,05	0,02–0,03	0,05–0,07	0,08–0,12	0,02–0,05	0,05–0,07	0,08–0,12	○	●	
N.1.1	0,02–0,05	0,01–0,02	0,04–0,06	0,07–0,10	0,02–0,05	0,04–0,06	0,07–0,10	●	○	
N.1.2	0,02–0,05	0,01–0,02	0,04–0,06	0,07–0,10	0,02–0,05	0,04–0,06	0,07–0,10	●	○	
N.2.1	0,02–0,05	0,04–0,05	0,06–0,08	0,08–0,12	0,02–0,05	0,06–0,08	0,08–0,12	●	○	
N.2.2	0,02–0,05	0,04–0,05	0,06–0,08	0,08–0,12	0,02–0,05	0,06–0,08	0,08–0,12	●	○	
N.2.3	0,02–0,05	0,04–0,05	0,06–0,08	0,08–0,12	0,02–0,05	0,06–0,08	0,08–0,12	●	○	
N.3.1	0,02–0,05	0,01–0,02	0,03–0,04	0,06–0,08	0,02–0,05	0,03–0,04	0,06–0,08	●	○	
N.3.2	0,02–0,05	0,01–0,02	0,03–0,04	0,06–0,08	0,02–0,05	0,03–0,04	0,06–0,08	●	○	
N.3.3	0,02–0,05	0,04–0,05	0,06–0,08	0,11–0,15	0,02–0,05	0,06–0,08	0,11–0,15	●	○	
N.4.1	0,02–0,05	0,01–0,02	0,03–0,04	0,06–0,08	0,02–0,05	0,03–0,04	0,06–0,08	●	○	
S.1.1	0,02–0,08	0,01–0,015	0,03–0,04	0,06–0,08	0,02–0,08	0,03–0,04	0,06–0,08	●	○	
S.1.2	0,02–0,08	0,01–0,015	0,02–0,03	0,04–0,06	0,02–0,08	0,02–0,03	0,04–0,06	●	○	
S.2.1	0,02–0,08	0,01–0,015	0,03–0,04	0,06–0,08	0,02–0,08	0,03–0,04	0,06–0,08	●	○	
S.2.2	0,02–0,08	0,01–0,015	0,02–0,03	0,04–0,06	0,02–0,08	0,02–0,03	0,04–0,06	●	○	
S.2.3	0,02–0,08	0,01–0,015	0,06–0,08	0,04–0,06	0,02–0,08	0,06–0,08	0,04–0,06	●	○	
S.3.1	0,02–0,08	0,01–0,015	0,03–0,04	0,06–0,08	0,02–0,08	0,03–0,04	0,06–0,08	●	○	
S.3.2	0,02–0,08	0,01–0,015	0,03–0,04	0,06–0,08	0,02–0,08	0,03–0,04	0,06–0,08	●	○	
S.3.3	0,02–0,08	0,01–0,015	0,01–0,02	0,03–0,04	0,02–0,08	0,01–0,02	0,03–0,04	●	○	
H.1.1	0,02–0,05		0,04–0,05	0,06–0,08	0,02–0,05	0,04–0,05	0,06–0,08		●	
H.1.2	0,02–0,05		0,04–0,05	0,06–0,08	0,02–0,05	0,04–0,05	0,06–0,08		●	
H.1.3	0,02–0,05		0,02–0,03	0,03–0,04	0,02–0,05	0,02–0,03	0,03–0,04		●	
H.1.4										
H.2.1	0,02–0,05		0,04–0,05	0,06–0,08	0,02–0,05	0,04–0,05	0,06–0,08		●	
H.3.1	0,02–0,05		0,04–0,05	0,06–0,08	0,02–0,05	0,04–0,05	0,06–0,08		●	
O.1.1	0,02–0,05		0,06–0,08	0,06–0,08	0,02–0,05	0,06–0,08	0,06–0,08	○	●	
O.1.2	0,02–0,05		0,06–0,08	0,06–0,08	0,02–0,05	0,06–0,08	0,06–0,08	○	●	
O.2.1										
O.2.2	0,02–0,05		0,06–0,08	0,07–0,10	0,02–0,05	0,06–0,08	0,07–0,10		●	
O.3.1	0,02–0,05		0,06–0,08	0,07–0,10	0,02–0,05	0,06–0,08	0,07–0,10		●	

5

 The cutting data is significantly dependent on the external conditions, e.g. stability of the tool and workpiece clamping, material and machine type! The specified values represent guideline cutting data that can be adjusted within the range according to the usage conditions! It is essential to observe the v_c values of the type used (page 65+66), the maximum speeds of the system and the reduction of these maximum speeds depending on the type used overhang length. You can find these on pages 72+74.

Cutting data standard values for precision adjustment heads – MicroKom

Index	62 815 ...		62 810 ...			● 1st choice		
	M03 Speed		FF precision adjustment head			○ suitable		
	Fine machining with depth of cut $a_p = 0.1 - 0.2$ mm		Fine machining with depth of cut $a_p = 0.1 - 0.2$ mm			Emulsion	Compressed air	MMS
	Ø 24,8 – 63	Ø 63 – 206	Ø 29,5 – 50	Ø 47 – 83	Ø 79 – 199			
f (mm/rev)		f (mm/rev)						
P.1.1	0,06–0,08	0,07–0,10	0,06–0,08	0,07–0,10	0,11–0,15	●	○	○
P.1.2	0,07–0,10	0,11–0,15	0,07–0,10	0,11–0,15	0,14–0,20	●	○	○
P.1.3	0,06–0,08	0,08–0,12	0,06–0,08	0,08–0,12	0,14–0,20	●	○	○
P.1.4	0,05–0,07	0,07–0,10	0,05–0,07	0,07–0,10	0,13–0,18	●	○	○
P.1.5	0,06–0,09	0,09–0,13	0,06–0,09	0,09–0,13	0,13–0,18	●	○	○
P.2.1	0,06–0,08	0,08–0,12	0,06–0,08	0,08–0,12	0,14–0,20	●	○	○
P.2.2	0,05–0,07	0,07–0,10	0,05–0,07	0,07–0,10	0,13–0,18	●	○	○
P.2.3	0,06–0,08	0,07–0,10	0,06–0,08	0,07–0,10	0,14–0,20	●	○	○
P.2.4	0,04–0,06	0,06–0,08	0,04–0,06	0,06–0,08	0,07–0,10	●	○	○
P.3.1	0,04–0,06	0,07–0,10	0,04–0,06	0,07–0,10	0,11–0,15	●	○	○
P.3.2	0,03–0,04	0,06–0,08	0,03–0,04	0,06–0,08	0,08–0,12	●	○	○
P.3.3	0,03–0,04	0,05–0,07	0,03–0,04	0,05–0,07	0,07–0,10	●	○	○
P.4.1	0,04–0,06	0,07–0,10	0,04–0,06	0,07–0,10	0,11–0,15	●	○	○
P.4.2	0,03–0,04	0,06–0,08	0,03–0,04	0,06–0,08	0,08–0,12	●	○	○
M.1.1	0,04–0,06	0,07–0,10	0,04–0,06	0,07–0,10	0,11–0,15	●	○	○
M.2.1	0,04–0,06	0,07–0,10	0,04–0,06	0,07–0,10	0,11–0,15	●	○	○
M.3.1	0,04–0,05	0,06–0,09	0,04–0,05	0,06–0,09	0,08–0,12	●	○	○
K.1.1	0,11–0,15	0,14–0,20	0,11–0,15	0,14–0,20	0,21–0,30	○	●	○
K.1.2	0,11–0,15	0,14–0,20	0,11–0,15	0,14–0,20	0,21–0,30	○	●	○
K.2.1	0,07–0,10	0,11–0,15	0,07–0,10	0,11–0,15	0,18–0,25	○	●	○
K.2.2	0,06–0,08	0,08–0,12	0,06–0,08	0,08–0,12	0,14–0,20	○	●	○
K.3.1	0,07–0,10	0,11–0,15	0,07–0,10	0,11–0,15	0,18–0,25	○	●	○
K.3.2	0,06–0,08	0,08–0,12	0,06–0,08	0,08–0,12	0,14–0,20	○	●	○
N.1.1	0,06–0,08	0,08–0,12	0,06–0,08	0,08–0,12	0,11–0,15	●	○	○
N.1.2	0,06–0,08	0,08–0,12	0,06–0,08	0,08–0,12	0,11–0,15	●	○	○
N.2.1	0,07–0,10	0,11–0,15	0,07–0,10	0,11–0,15	0,14–0,20	●	○	○
N.2.2	0,07–0,10	0,11–0,15	0,07–0,10	0,11–0,15	0,14–0,20	●	○	○
N.2.3	0,06–0,09	0,08–0,12	0,06–0,09	0,08–0,12	0,13–0,18	●	○	○
N.3.1	0,07–0,10	0,11–0,15	0,07–0,10	0,11–0,15	0,14–0,20	●	○	○
N.3.2	0,07–0,10	0,11–0,15	0,07–0,10	0,11–0,15	0,15–0,22	●	○	○
N.3.3	0,07–0,10	0,11–0,15	0,07–0,10	0,11–0,15	0,14–0,20	●	○	○
N.4.1	0,07–0,10	0,11–0,15	0,07–0,10	0,11–0,15	0,14–0,20	●	○	○
S.1.1	0,04–0,06	0,06–0,08	0,04–0,06	0,06–0,08	0,07–0,10	●	○	○
S.1.2	0,03–0,04	0,04–0,06	0,03–0,04	0,04–0,06	0,06–0,08	●	○	○
S.2.1	0,04–0,06	0,06–0,08	0,04–0,06	0,06–0,08	0,07–0,10	●	○	○
S.2.2	0,03–0,04	0,04–0,06	0,03–0,04	0,04–0,06	0,06–0,08	●	○	○
S.2.3	0,03–0,04	0,04–0,06	0,03–0,04	0,04–0,06	0,04–0,06	●	○	○
S.3.1	0,04–0,06	0,06–0,08	0,04–0,06	0,06–0,08	0,08–0,11	●	○	○
S.3.2	0,04–0,06	0,06–0,08	0,04–0,06	0,06–0,08	0,07–0,10	●	○	○
S.3.3	0,03–0,04	0,04–0,06	0,03–0,04	0,04–0,06	0,07–0,10	●	○	○
H.1.1	0,06–0,08	0,06–0,08	0,06–0,08	0,06–0,08	0,07–0,10		●	○
H.1.2	0,04–0,06	0,04–0,06	0,04–0,06	0,04–0,06	0,06–0,08		●	○
H.1.3	0,03–0,04	0,03–0,04	0,03–0,04	0,03–0,04	0,03–0,04		●	○
H.1.4								
H.2.1	0,04–0,05	0,04–0,06	0,04–0,05	0,04–0,06	0,07–0,10		●	○
H.3.1	0,04–0,05	0,04–0,06	0,04–0,05	0,04–0,06	0,06–0,08		●	○
O.1.1	0,06–0,08	0,06–0,08	0,06–0,08	0,06–0,08	0,06–0,08	○	●	○
O.1.2	0,06–0,08	0,06–0,08	0,06–0,08	0,06–0,08	0,06–0,08	○	●	○
O.2.1								
O.2.2	0,06–0,08	0,06–0,08	0,06–0,08	0,06–0,08	0,06–0,08		●	
O.3.1	0,06–0,08	0,06–0,08	0,06–0,08	0,06–0,08	0,06–0,08		●	

 The cutting data is significantly dependent on the external conditions, e.g. stability of the tool and workpiece clamping, material and machine type! The specified values represent guideline cutting data that can be adjusted within the range according to the usage conditions! It is essential to observe the v_c values of the type used (page 65+66), the maximum speeds of the system and the reduction of these maximum speeds depending on the type used overhang length. You can find these on pages 72+74.

Cutting data standard values for finish boring heads – SpinTools

Index	62 303 ..., 62 308 ...	62 305 ...	● 1st choice ○ suitable			62 382 ..., 62 386 ...	62 372 ..., 62 373 ...	62 326 ..., 62 332 ..., 62 333 ..., 62 363 ...	62 304 ...	● 1st choice ○ suitable		
	Single point finish boring head		Emulsion	Compressed air	MMS	Micro Boring Head	Multi-Head boring and fine boring head	Single point boring head	Fine boring head	Emulsion	Compressed air	MMS
	$a_p = 0,1 - 0,4$					$a_p = 0,1 - 0,2$	$a_p = 0,1 - 0,4$	$a_p = 0,1 - 0,4$	$a_p = 0,1 - 0,4$			
	$\varnothing 23,9 - 116,1$ $\varnothing 86 - 402$		$\varnothing 0,3 - 19,1$		$\varnothing 2 - 320$		$\varnothing 3 - 88$		$\varnothing 14,7 - 24,1$			
f (mm/rev)												
P.1.1	0,03-0,12	0,03-0,12	●	○		0,02	0,03-0,12	0,03-0,12	0,03-0,10	●	○	○
P.1.2	0,03-0,12	0,03-0,12	●	○		0,02	0,03-0,12	0,03-0,12	0,03-0,10	●	○	○
P.1.3	0,03-0,12	0,03-0,12	●	○		0,02	0,03-0,12	0,03-0,12	0,03-0,10	●	○	○
P.1.4	0,03-0,12	0,03-0,12	●	○		0,02	0,03-0,12	0,03-0,12	0,03-0,10	●	○	○
P.1.5	0,03-0,12	0,03-0,12	●	○		0,02	0,03-0,12	0,03-0,12	0,03-0,10	●	○	○
P.2.1	0,03-0,12	0,03-0,12	●	○		0,02	0,03-0,12	0,03-0,12	0,03-0,10	●	○	○
P.2.2	0,03-0,12	0,03-0,12	●	○		0,02	0,03-0,12	0,03-0,12	0,03-0,10	●	○	○
P.2.3	0,03-0,12	0,03-0,12	●	○		0,02	0,03-0,12	0,03-0,12	0,03-0,10	●	○	○
P.2.4	0,03-0,12	0,03-0,12	●	○		0,02	0,03-0,12	0,03-0,12	0,03-0,10	●	○	○
P.3.1	0,03-0,12	0,03-0,12	●	○		0,02	0,03-0,12	0,03-0,12	0,03-0,10	●	○	○
P.3.2	0,03-0,12	0,03-0,12	●	○		0,02	0,03-0,12	0,03-0,12	0,03-0,10	●	○	○
P.3.3	0,03-0,12	0,03-0,12	●	○		0,02	0,03-0,12	0,03-0,12	0,03-0,10	●	○	○
P.4.1	0,03-0,12	0,03-0,12	●	○		0,02	0,03-0,12	0,03-0,12	0,03-0,10	●	○	○
P.4.2	0,03-0,12	0,03-0,12	●	○		0,02	0,03-0,12	0,03-0,12	0,03-0,10	●	○	○
M.1.1	0,03-0,12	0,03-0,12	●	○		0,02	0,03-0,12	0,03-0,12	0,03-0,10	●	○	○
M.2.1	0,03-0,12	0,03-0,12	●	○		0,02	0,03-0,12	0,03-0,12	0,03-0,10	●	○	○
M.3.1	0,03-0,12	0,03-0,12	●	○		0,02	0,03-0,12	0,03-0,12	0,03-0,10	●	○	○
K.1.1	0,03-0,12	0,03-0,12	○	●		0,02	0,03-0,12	0,03-0,12	0,03-0,10	○	●	○
K.1.2	0,03-0,12	0,03-0,12	○	●		0,02	0,03-0,12	0,03-0,12	0,03-0,10	○	●	○
K.2.1	0,03-0,12	0,03-0,12	○	●		0,02	0,03-0,12	0,03-0,12	0,03-0,10	○	●	○
K.2.2	0,03-0,12	0,03-0,12	○	●		0,02	0,03-0,12	0,03-0,12	0,03-0,10	○	●	○
K.3.1	0,03-0,12	0,03-0,12	○	●		0,02	0,03-0,12	0,03-0,12	0,03-0,10	○	●	○
K.3.2	0,03-0,12	0,03-0,12	○	●		0,02	0,03-0,12	0,03-0,12	0,03-0,10	○	●	○
N.1.1	0,03-0,12	0,03-0,12	●	○		0,02	0,03-0,12	0,03-0,12	0,03-0,10	●	○	○
N.1.2	0,03-0,12	0,03-0,12	●	○		0,02	0,03-0,12	0,03-0,12	0,03-0,10	●	○	○
N.2.1	0,03-0,12	0,03-0,12	●	○		0,02	0,03-0,12	0,03-0,12	0,03-0,10	●	○	○
N.2.2	0,03-0,12	0,03-0,12	●	○		0,02	0,03-0,12	0,03-0,12	0,03-0,10	●	○	○
N.2.3	0,03-0,12	0,03-0,12	●	○		0,02	0,03-0,12	0,03-0,12	0,03-0,10	●	○	○
N.3.1	0,03-0,12	0,03-0,12	●	○		0,02	0,03-0,12	0,03-0,12	0,03-0,10	●	○	○
N.3.2	0,03-0,12	0,03-0,12	●	○		0,02	0,03-0,12	0,03-0,12	0,03-0,10	●	○	○
N.3.3	0,03-0,12	0,03-0,12	●	○		0,02	0,03-0,12	0,03-0,12	0,03-0,10	●	○	○
N.4.1	0,03-0,12	0,03-0,12	●	○		0,02	0,03-0,12	0,03-0,12	0,03-0,10	●	○	○
S.1.1	0,03-0,12	0,03-0,12	●	○		0,02	0,03-0,12	0,03-0,12	0,03-0,10	●	○	○
S.1.2	0,03-0,12	0,03-0,12	●	○		0,02	0,03-0,12	0,03-0,12	0,03-0,10	●	○	○
S.2.1	0,03-0,12	0,03-0,12	●	○		0,02	0,03-0,12	0,03-0,12	0,03-0,10	●	○	○
S.2.2	0,03-0,12	0,03-0,12	●	○		0,02	0,03-0,12	0,03-0,12	0,03-0,10	●	○	○
S.2.3	0,03-0,12	0,03-0,12	●	○		0,02	0,03-0,12	0,03-0,12	0,03-0,10	●	○	○
S.3.1	0,03-0,12	0,03-0,12	●	○		0,02	0,03-0,12	0,03-0,12	0,03-0,10	●	○	○
S.3.2	0,03-0,12	0,03-0,12	●	○		0,02	0,03-0,12	0,03-0,12	0,03-0,10	●	○	○
S.3.3	0,03-0,12	0,03-0,12	●	○		0,02	0,03-0,12	0,03-0,12	0,03-0,10	●	○	○
H.1.1	0,03-0,12	0,03-0,12	○	●		0,02	0,03-0,12	0,03-0,12	0,03-0,10	○	●	○
H.1.2	0,03-0,12	0,03-0,12	○	●		0,02	0,03-0,12	0,03-0,12	0,03-0,10	○	●	○
H.1.3	0,03-0,12	0,03-0,12	○	●		0,02	0,03-0,12	0,03-0,12	0,03-0,10	○	●	○
H.1.4												
H.2.1	0,03-0,12	0,03-0,12	○	●		0,02	0,03-0,12	0,03-0,12	0,03-0,10	○	●	○
H.3.1	0,03-0,12	0,03-0,12	○	●		0,02	0,03-0,12	0,03-0,12	0,03-0,10	○	●	○
O.1.1	0,03-0,12	0,03-0,12	○	●		0,02	0,03-0,12	0,03-0,12	0,03-0,10	○	●	○
O.1.2	0,03-0,12	0,03-0,12	○	●		0,02	0,03-0,12	0,03-0,12	0,03-0,10	○	●	○
O.2.1	0,03-0,12	0,03-0,12	○	●		0,02	0,03-0,12	0,03-0,12	0,03-0,10	○	●	○
O.2.2	0,03-0,12	0,03-0,12		●		0,02	0,03-0,12	0,03-0,12	0,03-0,10		●	
O.3.1	0,03-0,12	0,03-0,12		●		0,02	0,03-0,12	0,03-0,12	0,03-0,10		●	

5

 The cutting data is significantly dependent on the external conditions, e.g. stability of the tool and workpiece clamping, material and machine type! The specified values represent guideline cutting data that can be adjusted within the range (i.e. by $\pm 20\%$) according to the usage conditions! It is essential to observe the v_c values of the type used (page 65+66), the maximum speeds of the system and the reduction of these maximum speeds depending on the type used overhang length. You can find these on pages 72+74.

Cutting data standard values for boring heads for roughing – TwinKom

Index	62 870 ...							● 1st choice		
	Twin cutters							○ suitable		
	Cutting depth $a_p = 1 - 9$ mm							Emulsion	Compressed air	MMS
	Ø 24-32	Ø 30-41	Ø 39-53	Ø 51-71	Ø 64-91	Ø 83-124	Ø 109-215			
f (mm/rev)										
P.1.1	0,14-0,20	0,17-0,24	0,22-0,30	0,28-0,40	0,32-0,45	0,35-0,50	0,35-0,50	●	○	○
P.1.2	0,14-0,20	0,17-0,24	0,22-0,30	0,28-0,40	0,32-0,45	0,35-0,50	0,35-0,50	●	○	○
P.1.3	0,14-0,20	0,17-0,24	0,22-0,30	0,28-0,40	0,32-0,45	0,35-0,50	0,35-0,50	●	○	○
P.1.4	0,14-0,20	0,17-0,24	0,22-0,30	0,28-0,40	0,32-0,45	0,35-0,50	0,35-0,50	●	○	○
P.1.5	0,14-0,20	0,17-0,24	0,22-0,30	0,28-0,40	0,32-0,45	0,35-0,50	0,35-0,50	●	○	○
P.2.1	0,14-0,20	0,17-0,24	0,22-0,30	0,28-0,40	0,32-0,45	0,35-0,50	0,35-0,50	●	○	○
P.2.2	0,14-0,20	0,17-0,24	0,22-0,30	0,28-0,40	0,32-0,45	0,35-0,50	0,35-0,50	●	○	○
P.2.3	0,14-0,20	0,17-0,24	0,22-0,30	0,28-0,40	0,32-0,45	0,35-0,50	0,35-0,50	●	○	○
P.2.4	0,14-0,20	0,17-0,24	0,22-0,30	0,28-0,40	0,32-0,45	0,35-0,50	0,35-0,50	●	○	○
P.3.1	0,11-0,15	0,14-0,20	0,18-0,25	0,22-0,32	0,27-0,38	0,29-0,42	0,29-0,42	●	○	○
P.3.2	0,11-0,15	0,14-0,20	0,18-0,25	0,22-0,32	0,27-0,38	0,29-0,42	0,29-0,42	●	○	○
P.3.3	0,11-0,15	0,14-0,20	0,18-0,25	0,22-0,32	0,27-0,38	0,29-0,42	0,29-0,42	●	○	○
P.4.1	0,08-0,12	0,11-0,15	0,14-0,20	0,18-0,25	0,20-0,28	0,25-0,35	0,25-0,35	●	○	○
P.4.2	0,08-0,12	0,11-0,15	0,14-0,20	0,18-0,25	0,20-0,28	0,25-0,35	0,25-0,35	●	○	○
M.1.1	0,10-0,14	0,13-0,18	0,17-0,24	0,17-0,24	0,21-0,30	0,28-0,40	0,32-0,45	●	○	○
M.2.1	0,10-0,14	0,13-0,18	0,17-0,24	0,28-0,40	0,21-0,30	0,28-0,40	0,32-0,45	●	○	○
M.3.1	0,08-0,12	0,10-0,14	0,14-0,20	0,14-0,20	0,18-0,25	0,21-0,30	0,25-0,35	●	○	○
K.1.1	0,18-0,25	0,21-0,30	0,28-0,40	0,35-0,50	0,39-0,55	0,42-0,60	0,42-0,60	○	●	○
K.1.2	0,18-0,25	0,21-0,30	0,28-0,40	0,35-0,50	0,39-0,55	0,42-0,60	0,42-0,60	○	●	○
K.2.1	0,18-0,25	0,21-0,30	0,28-0,40	0,35-0,50	0,39-0,55	0,42-0,60	0,42-0,60	○	●	○
K.2.2	0,15-0,22	0,20-0,28	0,21-0,30	0,32-0,45	0,32-0,45	0,35-0,50	0,35-0,50	○	●	○
K.3.1	0,14-0,20	0,17-0,24	0,20-0,28	0,25-0,35	0,28-0,40	0,32-0,45	0,32-0,45	○	●	○
K.3.2	0,14-0,20	0,17-0,24	0,20-0,28	0,25-0,35	0,28-0,40	0,32-0,45	0,32-0,45	○	●	○
N.1.1	0,18-0,25	0,21-0,30	0,35-0,50	0,35-0,50	0,42-0,60	0,49-0,70	0,49-0,70	●	○	○
N.1.2	0,18-0,25	0,21-0,30	0,35-0,50	0,35-0,50	0,42-0,60	0,49-0,70	0,49-0,70	●	○	○
N.2.1	0,18-0,25	0,21-0,30	0,35-0,50	0,35-0,50	0,42-0,60	0,49-0,70	0,49-0,70	●	○	○
N.2.2	0,18-0,25	0,21-0,30	0,35-0,50	0,35-0,50	0,42-0,60	0,49-0,70	0,49-0,70	●	○	○
N.2.3	0,18-0,25	0,21-0,30	0,35-0,50	0,35-0,50	0,42-0,60	0,49-0,70	0,49-0,70	●	○	○
N.3.1	0,18-0,25	0,21-0,30	0,35-0,50	0,35-0,50	0,42-0,60	0,49-0,70	0,49-0,70	●	○	○
N.3.2	0,18-0,25	0,21-0,30	0,35-0,50	0,35-0,50	0,42-0,60	0,49-0,70	0,49-0,70	●	○	○
N.3.3	0,18-0,25	0,21-0,30	0,35-0,50	0,35-0,50	0,42-0,60	0,49-0,70	0,49-0,70	●	○	○
N.4.1	0,18-0,25	0,21-0,30	0,35-0,50	0,35-0,50	0,42-0,60	0,49-0,70	0,49-0,70	●	○	○
S.1.1	0,08-0,12	0,08-0,12	0,08-0,12	0,10-0,14	0,13-0,18	0,14-0,20	0,14-0,20	●	○	○
S.1.2	0,07-0,10	0,07-0,10	0,07-0,10	0,08-0,11	0,10-0,14	0,11-0,16	0,11-0,16	●	○	○
S.2.1	0,08-0,12	0,08-0,12	0,08-0,12	0,10-0,14	0,13-0,18	0,14-0,20	0,14-0,20	●	○	○
S.2.2	0,07-0,10	0,07-0,10	0,07-0,10	0,08-0,11	0,13-0,18	0,11-0,16	0,11-0,16	●	○	○
S.2.3	0,07-0,10	0,07-0,10	0,07-0,10	0,08-0,11	0,10-0,14	0,11-0,16	0,11-0,16	●	○	○
S.3.1	0,08-0,12	0,08-0,12	0,08-0,12	0,10-0,14	0,13-0,18	0,14-0,20	0,14-0,20	●	○	○
S.3.2	0,08-0,12	0,08-0,12	0,08-0,12	0,10-0,14	0,13-0,18	0,14-0,20	0,14-0,20	●	○	○
S.3.3	0,07-0,10	0,07-0,10	0,07-0,10	0,08-0,11	0,13-0,18	0,11-0,16	0,11-0,16	●	○	○
H.1.1										
H.1.2										
H.1.3										
H.1.4										
H.2.1										
H.3.1										
O.1.1	0,11-0,16	0,11-0,16	0,11-0,16	0,14-0,20	0,14-0,20	0,14-0,20	0,14-0,20	○	●	○
O.1.2	0,11-0,16	0,11-0,16	0,11-0,16	0,14-0,20	0,14-0,20	0,14-0,20	0,14-0,20	○	●	○
O.2.1										
O.2.2	0,06-0,08	0,06-0,08	0,07-0,10	0,07-0,10	0,08-0,12	0,08-0,12	0,10-0,14		●	
O.3.1	0,06-0,08	0,06-0,08	0,07-0,10	0,07-0,10	0,09-0,12	0,08-0,12	0,10-0,14		●	

 The cutting data is significantly dependent on the external conditions, e.g. stability of the tool and workpiece clamping, material and machine type! The specified values represent guideline cutting data that can be adjusted within the range according to the usage conditions! It is essential to observe the v_c values of the type used (page 65+66), the maximum speeds of the system and the reduction of these maximum speeds depending on the type used overhang length. You can find these on pages 72+74.

Cutting data standard values for boring heads for roughing – SpinTools

Index	62 295 ...			● 1st choice		
	Twin rough boring head			○ suitable		
	Cutting depth $a_p = 2.5 - 7$ mm			Emulsion	Compressed air	MMS
	Ø 23,5–40,5	Ø 40,5–66,5	Ø 66,5–87,5			
f (mm/rev)						
P.1.1	0,3–0,4	0,4–0,5	0,5–0,7	●	○	
P.1.2	0,3–0,4	0,4–0,5	0,5–0,7	●	○	
P.1.3	0,3–0,4	0,4–0,5	0,5–0,7	●	○	
P.1.4	0,3–0,4	0,4–0,5	0,5–0,7	●	○	
P.1.5	0,3–0,4	0,4–0,5	0,5–0,7	●	○	
P.2.1	0,3–0,4	0,4–0,5	0,5–0,7	●	○	
P.2.2	0,3–0,4	0,4–0,5	0,5–0,7	●	○	
P.2.3	0,3–0,4	0,4–0,5	0,5–0,7	●	○	
P.2.4	0,3–0,4	0,4–0,5	0,5–0,7	●	○	
P.3.1	0,3–0,4	0,4–0,5	0,5–0,7	●	○	
P.3.2	0,3–0,4	0,4–0,5	0,5–0,7	●	○	
P.3.3	0,3–0,4	0,4–0,5	0,5–0,7	●	○	
P.4.1	0,3–0,4	0,4–0,5	0,5–0,7	●	○	
P.4.2	0,3–0,4	0,4–0,5	0,5–0,7	●	○	
M.1.1	0,3–0,4	0,4–0,5	0,5–0,7	●	○	
M.2.1	0,3–0,4	0,4–0,5	0,5–0,7	●	○	
M.3.1	0,3–0,4	0,4–0,5	0,5–0,7	●	○	
K.1.1	0,3–0,4	0,4–0,5	0,5–0,7	○	●	
K.1.2	0,3–0,4	0,4–0,5	0,5–0,7	○	●	
K.2.1	0,3–0,4	0,4–0,5	0,5–0,7	○	●	
K.2.2	0,3–0,4	0,4–0,5	0,5–0,7	○	●	
K.3.1	0,3–0,4	0,4–0,5	0,5–0,7	○	●	
K.3.2	0,3–0,4	0,4–0,5	0,5–0,7	○	●	
N.1.1	0,3–0,4	0,4–0,5	0,5–0,7	●	○	
N.1.2	0,3–0,4	0,4–0,5	0,5–0,7	●	○	
N.2.1	0,3–0,4	0,4–0,5	0,5–0,7	●	○	
N.2.2	0,3–0,4	0,4–0,5	0,5–0,7	●	○	
N.2.3	0,3–0,4	0,4–0,5	0,5–0,7	●	○	
N.3.1	0,3–0,4	0,4–0,5	0,5–0,7	●	○	
N.3.2	0,3–0,4	0,4–0,5	0,5–0,7	●	○	
N.3.3	0,3–0,4	0,4–0,5	0,5–0,7	●	○	
N.4.1	0,3–0,4	0,4–0,5	0,5–0,7	●	○	
S.1.1	0,3–0,4	0,4–0,5	0,5–0,7	●	○	
S.1.2	0,3–0,4	0,4–0,5	0,5–0,7	●	○	
S.2.1	0,3–0,4	0,4–0,5	0,5–0,7	●	○	
S.2.2	0,3–0,4	0,4–0,5	0,5–0,7	●	○	
S.2.3	0,3–0,4	0,4–0,5	0,5–0,7	●	○	
S.3.1	0,3–0,4	0,4–0,5	0,5–0,7	●	○	
S.3.2	0,3–0,4	0,4–0,5	0,5–0,7	●	○	
S.3.3	0,3–0,4	0,4–0,5	0,5–0,7	●	○	
H.1.1	0,3–0,4	0,4–0,5	0,5–0,7	○	●	
H.1.2	0,3–0,4	0,4–0,5	0,5–0,7	○	●	
H.1.3	0,3–0,4	0,4–0,5	0,5–0,7	○	●	
H.1.4						
H.2.1	0,3–0,4	0,4–0,5	0,5–0,7	○	●	
H.3.1	0,3–0,4	0,4–0,5	0,5–0,7	○	●	
O.1.1	0,3–0,4	0,4–0,5	0,5–0,7	○	●	
O.1.2	0,3–0,4	0,4–0,5	0,5–0,7	○	●	
O.2.1	0,3–0,4	0,4–0,5	0,5–0,7	○	●	
O.2.2	0,3–0,4	0,4–0,5	0,5–0,7		●	
O.3.1	0,3–0,4	0,4–0,5	0,5–0,7		●	

5

 The cutting data is significantly dependent on the external conditions, e.g. stability of the tool and workpiece clamping, material and machine type! The specified values represent guideline cutting data that can be adjusted within the range according to the usage conditions! It is essential to observe the v_c values of the type used (page 65+66), the maximum speeds of the system and the reduction of these maximum speeds depending on the type used overhang length. You can find these on pages 72+74.

Fine boring tools

Maximum speed

System / tool		Boring range	Maximum speed in slide centre position
		Ø (mm)	n_{max} in 1/min
	62 820 ... , 62 840 ... BluFlex 2	0,5–365	20.000
	62 800 ... hi.flex	0,5–365	17.500
	62 800 06089 hi.flex micro	0,5–60	30.000
	62 386 ... , 62 382 ... Micro Boring Head	0,3–19,1	30.000
	62 815 ... M03 Speed	24–39	40.000
		38–50	31.000
		49–63	24.000
		62–80	18.500
		79–103	15.000
		100–130	11.500
		128–168	10.000
	62 810 ... FF precision adjustment head	29,5–42	25.000
		39–50	18.000
		47–66	12.000
		58–83	9.000
		79–108	6.000
		100–141	4.000
		138–179	3.500
		178–199	3.000
			62 372 ... , 62 373 ... Multi-Head boring and fine boring head with bridge
164–320	250		
	62 305 ... Single point finish boring head with insert holder	86–138	1.150
		136–220	720
		188–302	520
		242–402	400

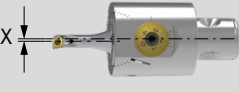
System / tool		Offset	
	Boring range	$X \leq 0,5 \text{ mm}$	$X > 0,5 \text{ mm}$
		Maximum speed n_{max} in 1/min	
Ø (mm)			
62 372 ... , 62 373 ... Multi-Head boring and fine boring head with boring bar	3–20	16.000	6.000
	20–48	12.000	4.000
62 326 ... , 62 332 ... , 62 333 ... , 62 363 ... Single point boring head with boring bar	48–88	8.000	2.000

System / tool		Unbalanced	Balanced
	Boring range	Maximum speed n_{max} in 1/min	
	Ø (mm)		
62 308 ... , 62 303 ... Single point finish boring head with insert holder	24–31	9.000	12.000
	31–40	7.500	10.000
	40–51	5.250	8.000
	51–67	4.000	6.500
	67–87	3.000	5.000
	87–116	2.500	4.000
	116–153	1.750	3.000

Selection of the maximum speed depending on the overhang length

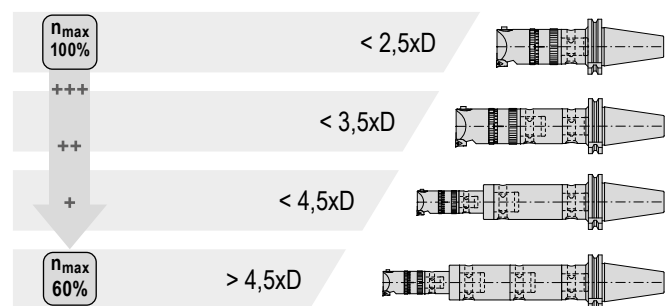

Scale accuracy

Large scale with 0.002 mm adjustment

How it works:

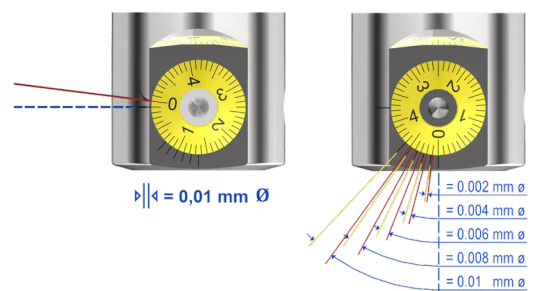

Fine boring tools

Maximum overhang length LTA at 35 mm shank clamping depth

LTA (mm)	High-speed boring head 62 361 ...														Fine boring head 62 304 ...			Boring bar 62 353 ...		
	014	015	016	017	018	019	020	021	022	023	025	027	030	033	037	040	017	020	024	
56																				008
	63																			009
		70																		010
			77																	011
				84																012
					91															013
						98														014
							98										115			016
								112	112	112	112	112	112	112	112	112		125		018
																			105	016
																			145	018
																			185	018
																				218

Selection of the cutting radius depending on the overhang length

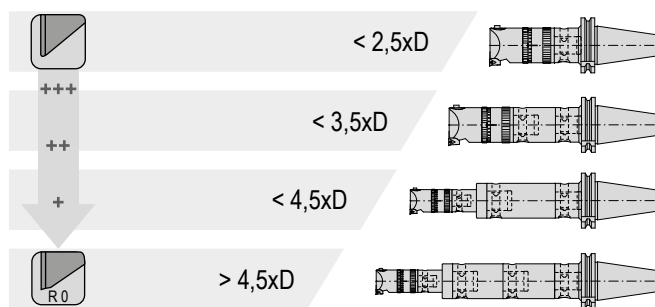

Selection of the cutting radius depending on the cutting depth a_p

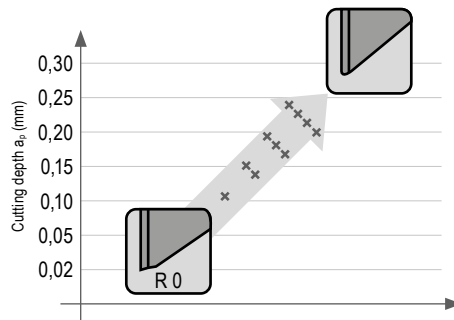

Influence of the cutting forces of the cutting edge radius on internal machining

Resulting force

$$F_{res} = \sqrt{F_a^2 + F_p^2} = \sqrt{F_c^2 + F_f^2 + F_p^2}$$

Tangential cutting force (F_c)

- ▲ pushes the tool down from the vertical central axis
- ▲ is influenced by the cutting depth and the chip thickness
- ▲ reduces the clearance angle

Passive cutting force (F_p)

- ▲ pushes the tool away from the horizontal central axis
- ▲ increases the risk of vibrations and causes dimensional inaccuracies

Feed force (F_f)

- ▲ acts in the machining direction of the tool

Active cutting force (F_a)

- ▲ determined by F_c and F_f

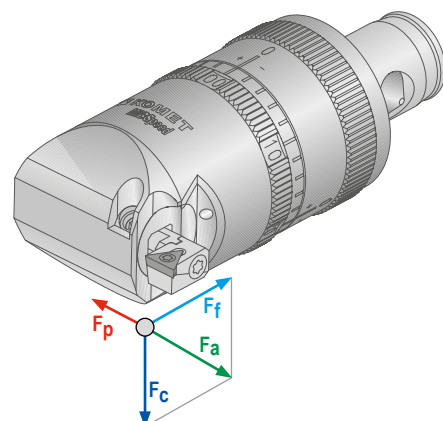
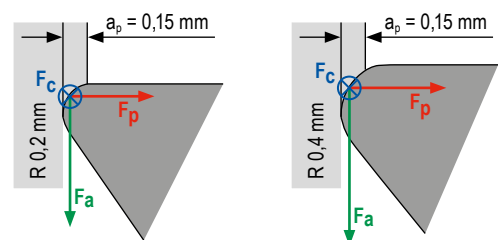

Counterboring tools

Maximum speed

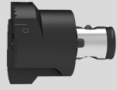
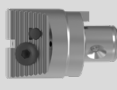
System / tool	Boring range Ø (mm)	Maximum speed n _{max} in 1/min
 62 870 ... TwinKom	24–31	12.000
	31–40	10.000
	40–51	8.000
	51–68	6.500
 62 295 ... Twin rough boring head	67–87	5.000
	87–116	4.000
	116–153	3.000
	153–215	2.200

Selection of the maximum speed

depending on the overhang length

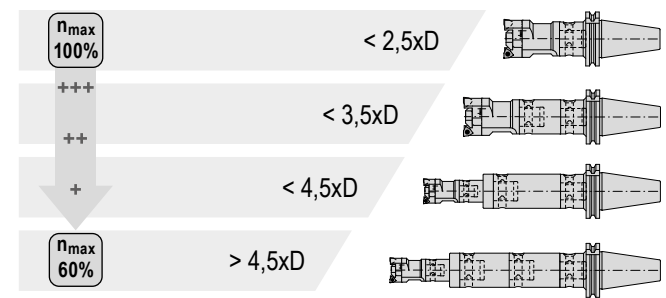

TwinKom applications

in pre-cast / premachined holes

Roughing as a "true" two-edged cutter

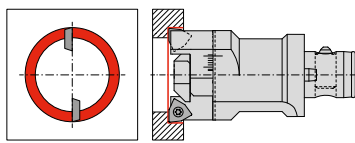

Axial adjustment required

Roughing with large allowance

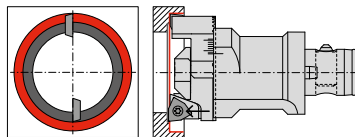

Roughing with large offset

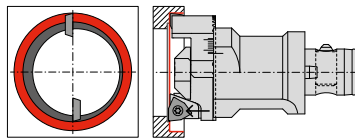

Roughing / Semi-Finishing

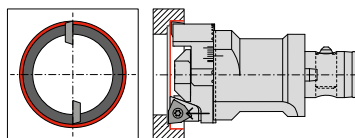

Cut distribution calculation

Example:
D2 (finished Ø) = 100 mm,
D1 (raw Ø) = 80 mm,
S (offset) = 3 mm

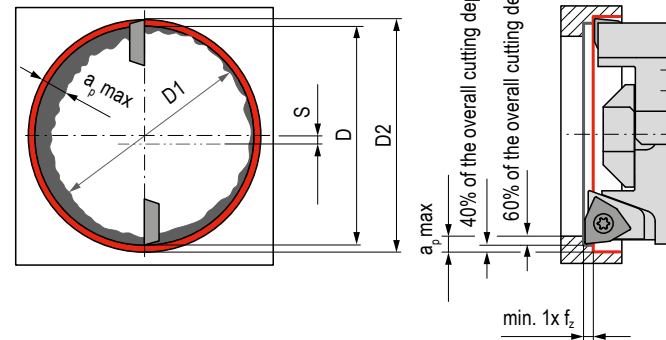

Calculation formula

$$D = D2 - \left[\left(\frac{D2 - D1}{2} \right) + S \right] \times 0,8$$

$$D = 100 - \left[\left(\frac{100 - 80}{2} \right) + 3 \right] \times 0,8 = 89,6 \text{ mm}$$

Feed rate guide values for surface finish quality

Roughness range R _z in µm	R _{th}	Corresponds to R _s	Roughness index	ISO 1302	Corner radius RE in mm and feed f in mm/rev						
					RE = 0,1	RE = 0,2	RE = 0,4	RE = 0,8	RE = 1,2	RE = 1,6	RE = 2,4
63–100	$\sqrt{R_{th63}}$	12,5–25	N11	$\frac{25}{\nabla}$	0,22*	0,32*	0,45*	0,63	0,78	0,9	1,1
40–63	$\sqrt{R_{th40}}$	6,3–12,5	N10	$\frac{12,5}{\nabla}$	0,18*	0,25*	0,36	0,51	0,62	0,72	0,88
31,5–40	$\sqrt{R_{th31,5}}$	4,9–6,3	N9	$\frac{6,3}{\nabla}$	0,16*	0,22*	0,32	0,45	0,55	0,63	0,78
25–31,5	$\sqrt{R_{th25}}$	4,0–4,9			0,14*	0,2*	0,28	0,4	0,49	0,57	0,69
16–25	$\sqrt{R_{th16}}$	2,5–4,0	N8	$\frac{3,2}{\nabla}$	0,11*	0,16	0,23	0,32	0,39	0,45	0,55
10–16	$\sqrt{R_{th10}}$	1,6–2,5			0,09	0,13	0,18	0,25	0,31	0,36	0,44
6,3–10	$\sqrt{R_{th6,3}}$	1,0–1,6	N7	$\frac{1,6}{\nabla}$	0,07	0,1	0,14	0,2	0,25	0,28	0,35
4–6,3	$\sqrt{R_{th4}}$	0,8–1,0			0,06	0,08	0,11	0,16	0,2	0,23	0,28
2,5–4	$\sqrt{R_{th2,5}}$	0,4–0,8	N5	$\frac{0,4}{\nabla}$	0,04	0,06	0,09	0,13	0,15	0,18	0,22
1,6–2,5	$\sqrt{R_{th1,6}}$	0,2–0,4			0,04	0,05	0,07	0,1	0,12	0,14	0,18
1–1,6	$\sqrt{R_{th1}}$	0,1–0,2	N3	$\frac{0,1}{\nabla}$	0,03	0,04	0,06	0,08	0,1	0,11	0,14







*Please ensure that the feed rate values used do not exceed the corner radius (RE).

 The feed rate values shown are recommended values and are based on purely theoretical calculations using the above-mentioned formula. These may however deviate in practice.

Insert

Selection of the rake angle

Recommendations for the usage of indexable inserts with ground chip breakers

	rounded	Sharp	chamfered
			
	P M K N S H	P M K N S H	P M K N S H
	P M K N S H	P M K N S H	P M K N S H
	P M K N S H	P M K N S H	P M K N S H
	P M K N S H	P M K N S H	P M K N S H





 Chip groove description → [page 79](#)

Number key

for MicroKom indexable inserts

W	2	9	2	4	0	1	0	.	0	4	8	4	2	5
	2	3	4	5	6	7	8		9	10	11	12	13	14

2-3 Type / shape

00	W...		84°	Regular version, periphery ground
29	W...		84°	Reinforced version
30	T...		60°	Periphery ground, clearance angle 8°
57	T...		60°	Periphery ground, clearance angle 11°
80	S...		90°	Periphery sintered

4-5 Size / IC

04	4,0 mm	18	6,2 mm 6,35 mm	28	8,9 mm	42	12,0 mm
10	4,8 mm 5,0 mm	20	7,0 mm 7,1 mm	32	9,52 mm 9,8 mm	46	13,2 mm
12	5,5 mm	24	8,0 mm	34	10,0 mm	50	15,0 mm
14	5,6 mm	26	8,2 mm	38	10,9 mm 11,1 mm	58	17,6 mm

6-7 Topography

Ground code

06	Left-hand cutting, 6°
12	Left-hand cutting, 12°
34	High-feed geometry, chamfered and rounded

Sintered code

01	Double grooves, cutting edge chamfered and rounded
02	Stepped geometry, cutting edge chamfered and rounded
03	Calotte geometry, cutting edge rounded
11	20° chip former, cutting edge rounded
12	Alu / finishing geometry
13	Shaft geometry, cutting edge rounded
14	Finishing topography
15	Semi-finishing topography
18	Finishing topography with wiper corner
32	Burr-minimised, periphery ground
33	Burr-minimised, periphery sintered

9-10 Corner radius

01	R 0,1	04	R 0,4
02	R 0,2	06	R 0,6
03	R 0,3	08	R 0,8

11-14 Grade

Grade description
→ [Page 80+81](#).

Notes on drilling technology – TwinKom

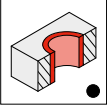
1.  Counterboring a through hole
▲ Possible without any problems

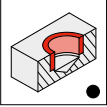
2.  Counterboring a blind hole
▲ Possible without any problems

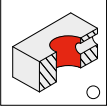
3.  Drilling through a transverse hole
▲ Reduce feed by up to 50%, if necessary
▲ Check for chip jamming on the periphery of the tool
▲ Use tough indexable inserts
▲ Use stable corner radius

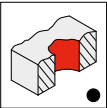
4.  Spot drilling uneven surfaces (casting surfaces)
▲ Feed must reduce by up to 40% when spot drilling
▲ Use tough indexable inserts
▲ Use stable corner radius

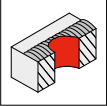
5.  Spot drilling a seam (forging/welding/casting seam)
▲ Reduce feed
▲ Use max. 3xD tools

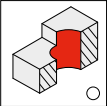
6.  Spot drilling an edge
▲ Reduce feed to 50%
▲ Use tough indexable inserts
▲ Use stable corner radius

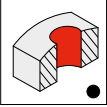
7.  Spot drilling convex surfaces
▲ Possible without any problems
▲ If necessary, reduce feed

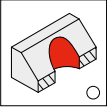
8.  Spot drilling angled surfaces
▲ From the interrupted cut, reduce the feed by up to 50%
▲ Use tough indexable inserts
▲ Use stable corner radius

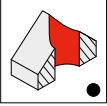
9.  Spot drilling a pointed contour
▲ Reduce the feed by up to 40% in the area where cutting is interrupted

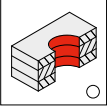
10.  Stack plate drilling
▲ Use holder with 80° positioning
▲ Good workpiece clamping required
▲ Max. gap size = 1 mm

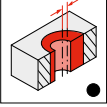
11.  Large hole offset
▲ Possible without any problems
▲ Axial-radial cut distribution, see graphic: Cut distribution

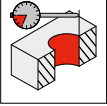
12.  Adjustable in diameter
▲ Possible without any problems

Problems / possible causes / solutions – Counterboring and fine boring

1. No chip breakage

- ▲ Cutting depth a_p too low for cutting edge topography used → If necessary, increase the cutting depth a_p
→ Use cutting edge topography for small to medium cutting depths
- ▲ Cutting depth a_p too big for cutting edge topography used → Reduce cutting depth a_p
→ Axial-radial cut distribution
→ Use cutting edge topography for larger cutting depths
- ▲ Feed/tooth too low → Increase feed/tooth
- ▲ RPM too high → Reduce RPM
- ▲ Cutting edges not same length axially → Correct axial offset: Use holder with axial length compensation

2. Chip jamming

- ▲ Unfavourable chip shape → Increase feed
→ Use cutting edge topography with chip breaker
→ Axial-radial cut distribution
→ See measures: 1. No chip breakage
- ▲ Workpiece clamping → In the case of through holes, check there is sufficient space for pecking behind the component
- ▲ Cooling lubricant pressure/quantity too low → Improve cooling lubricant pressure/quantity

3. Conical hole

- See measures: 1. No chip breakage

4. Poor surface quality

- ▲ Feed too high → Reduce feed
- ▲ Cutting speed too low → Increase cutting speed
- ▲ Cutting radius too small → Use indexable insert with a larger cutting radius
→ Use indexable insert with wiper geometry
- ▲ Rake angle of the indexable insert too small → Use indexable insert with positive cutting edge geometry
- ▲ Built-up edge → Use indexable insert with positive cutting edge geometry
→ Use indexable insert with wider chip breaker groove
- ▲ Unfavourable chip shape → See measures: 1. No chip breakage
→ See measures: 2. Chip jam

5. Vibration

- ▲ Tool design – high L/D ratio → If necessary, check tool design
→ If possible, consistently avoid the same boring bar \emptyset
→ If possible, stepped tool design; design tool to be as stable as possible
→ Check axial-radial cutting settings
→ Use vibration-optimised boring bar, if necessary
→ Use HMD damping element, if necessary
- ▲ Feed too high → Reduce feed
- ▲ Cutting speed too high → Reduce cutting speed,
see graphic: Selection of the cutting speed depending on the overhang length
- ▲ Depth of cut too big → Reduce depth of cut
→ Axial-radial cut distribution
- ▲ Cutting edge geometry too blunt → Use indexable insert with positive cutting edge geometry
→ Use indexable insert with wider chip breaker groove
- ▲ Cutting radius too big → Use indexable insert with a smaller cutting radius,
see graphic: Selection of the cutting radius depending on the overhang length and the depth of cut

Types of wear

Wear on clearance face



Abrasion on the flank: normal wear after a certain period of operation.

Cause

- ▲ Cutting speed too high
- ▲ Carbide grade does not have enough wear resistance
- ▲ Feed not adapted to application

Remedy

- ▲ Reduce cutting speed
- ▲ Select a carbide grade with high wear resistance
- ▲ Bring feed into the right relationship with cutting speed and cutting depth

Edge chipping

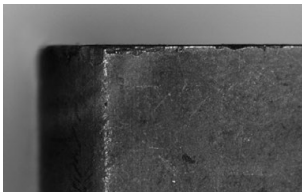

Increased mechanical stress on the cutting edge may result in carbide particles breaking off.

Cause

- ▲ Grade with too high a wear resistance
- ▲ Vibrations on tool or workpiece
- ▲ Feed rate or cutting depth is too high
- ▲ Built-up edge
- ▲ Interrupted cut
- ▲ Chip stroke

Remedy

- ▲ Use tougher grade
- ▲ Improve stability (tool, workpiece)
- ▲ Avoid built-up edges

Cratering

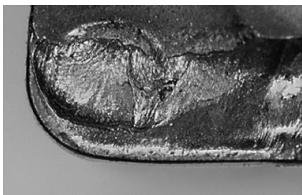

The outgoing hot chip is causing cratering of the cutting insert on the clamping surface.

Cause

- ▲ Cutting speed too high, feed too high
- ▲ Rake angle too low
- ▲ Grade does not have enough wear resistance
- ▲ Incorrectly supplied coolant

Remedy

- ▲ Reduce cutting speed and/or feed rate
- ▲ Choose carbide grades with greater wear-resistance
- ▲ Increase quantity and/or pressure of coolant, check supply
- ▲ Use a more crater-resistant grade

Plastic deformation

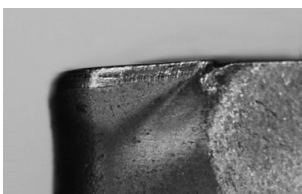

High machining temperature with simultaneous mechanical stress can lead to plastic deformation.

Cause

- ▲ Working temperature too high, softening of the base material
- ▲ Damage to the coating
- ▲ Grade does not have enough wear resistance
- ▲ Incorrectly supplied coolant

Remedy

- ▲ Reduce cutting speed
- ▲ Select more wear-resistant, more thermally stable carbide grade
- ▲ Make provisions for cooling / check supply

Built-up edge

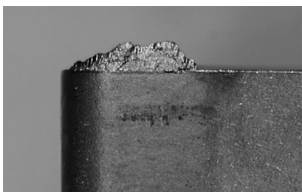

Material builds up on the cutting edge if the chip does not flow correctly due to the cutting temperature being too low.

Cause

- ▲ Cutting speed too low
- ▲ Rake angle too small
- ▲ Incorrect cutting material
- ▲ Missing coolant/lubrication

Remedy

- ▲ Increase cutting speed
- ▲ Increase rake angle
- ▲ Use TiN coating
- ▲ Make provisions for cooling / increase oil content of emulsion

Insert breakage

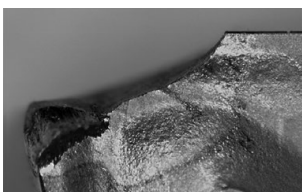

If a cutting insert is overloaded, insert breakage may occur.

Cause

- ▲ Cutting material overloaded (extreme values)
- ▲ Lack of stability
- ▲ Wedge angle too small
- ▲ Interference contours were not taken into account
- ▲ Interrupted cut

Remedy

- ▲ Use a tougher cutting material
- ▲ Use chamfer for edge protection
- ▲ Increase rounding of cutting edge
- ▲ Use more stable geometry
- ▲ Check cutting data
- ▲ Check interference contours

Chip breakers

-SF14	<ul style="list-style-type: none"> ▲ Rake angle 14° ▲ Specially developed chip breakers with remarkable chip control for a range of applications, from fine finishing to medium machining 	-11	<ul style="list-style-type: none"> ▲ Rake angle 20° ▲ Highly positive, minimally rounded chip breaker ▲ For soft-cutting usage ▲ Main application in aluminium
-SF15	<ul style="list-style-type: none"> ▲ Rake angle 15° ▲ Balanced geometry: high stability with high cutting edge sharpness ▲ Excellent chip control with minimum susceptibility to built-up edge formation ▲ Particularly good chip breakage with small and medium feeds ▲ Initial recommendation for machining C-steel, alloyed and stainless steels 	-12	<ul style="list-style-type: none"> ▲ Rake angle 30° ▲ Peripheral ground indexable insert with pressed chip breaker ▲ Highly positive, sharp and all-round cutting edge, therefore extremely smooth-cutting ▲ Peripheral ground flanks guarantee controlled chip formation and best surface quality at low cutting forces
-SF16	<ul style="list-style-type: none"> ▲ Rake angle 15° ▲ Balanced geometry: High stability for high cutting edge sharpness ▲ Large chip chamber, therefore good chip control at low feeds ▲ Initial recommendation for machining C-steel, alloyed and stainless steels 	-14	<ul style="list-style-type: none"> ▲ Rake angle 14° ▲ Peripheral ground, sintered topography ▲ Controlled chip formation in fine and extremely fine machining
-SF20	<ul style="list-style-type: none"> ▲ Rake angle 20° ▲ Particularly smooth cutting thanks to the extremely positive rake angle ▲ Excellent chip control with minimum susceptibility to built-up edge formation ▲ Perfect cutting performance thanks to the extremely positive rake angle, particularly with low depths of cut and feeds ▲ Initial recommendation for machining stainless steel, alloy steels, carbon steel and non-ferrous metals 	-15	<ul style="list-style-type: none"> ▲ Rake angle 15° ▲ Semi-finishing chip breaker; peripheral ground, sintered ▲ Controlled chip formation in fine and extremely fine machining
-SF30	<ul style="list-style-type: none"> ▲ Rake angle 15° ▲ Balanced geometry: High stability for high cutting edge sharpness ▲ Chip breaker geometry: Very good chip breakage for small and medium feeds ▲ Initial recommendation for machining C-steel, alloyed and stainless steels 	-18	<ul style="list-style-type: none"> ▲ Rake angle 14° ▲ Peripheral ground and sintered topography ▲ Controlled chip formation in fine and extremely fine machining ▲ Positive wiper geometry for maximum demands on surface quality
-01	<ul style="list-style-type: none"> ▲ Rake angle 12° ▲ All-round topography chamfered, rounded ▲ Very smooth-cutting thanks to positive cutting edge geometry ▲ Also suitable for less-powerful machines and unstable workpieces ▲ Easily controllable chip formation also in less solid materials 	-G06	<ul style="list-style-type: none"> ▲ Rake angle 6° ▲ For P / M / K materials ▲ High stability due to significant wedge angle
-02	<ul style="list-style-type: none"> ▲ Rake angle 0° ▲ Roughing topography, extremely stable (significant wedge angle) ▲ Excellent chip formation for chips that are difficult to control ▲ Only suitable for small cutting depths < 1.5 mm under certain circumstances 	-G12	<ul style="list-style-type: none"> ▲ Rake angle 12° ▲ For P / N / S materials ▲ Extremely smooth-cutting thanks to positive cutting edge geometry ▲ Extremely suitable for less-powerful machines and unstable workpieces ▲ Easily controllable chip formation also in less solid materials

Type

K10	<ul style="list-style-type: none"> ▲ Carbide, uncoated ▲ ISO K10 ▲ Uncoated carbide grade for machining grey cast iron or non-ferrous metals, depending on the cutting edge geometry 	BK7615	<ul style="list-style-type: none"> ▲ Carbide, TiCN-Al₂O₃-coated ▲ ISO K15 ▲ Highly productive grade with extreme edge stability for wet and dry machining of all cast iron materials
BK2710	<ul style="list-style-type: none"> ▲ Carbide, TiAlN-coated ▲ ISO P10 M10 K10 ▲ Extremely wear-resistant carbide grade for machining stainless steels, structural steels and tool steels as well as cast iron materials 	BK77	<ul style="list-style-type: none"> ▲ Carbide, TiN-coated ▲ ISO S10 H10 O10 ▲ The wear-resistant carbide grade for machining aluminum alloys, superalloys and plastics at medium cutting speeds
BK60	<ul style="list-style-type: none"> ▲ Carbide, TiC-TiCN-TiN-coated ▲ ISO P25 M10 ▲ Multi-layer coating for long service life even in the upper cutting speed range 	BK7710	<ul style="list-style-type: none"> ▲ Carbide, TiB₂-coated ▲ ISO N10 S10 O10 ▲ The wear-resistant grade with optimum cutting characteristics to prevent built-up edge formation for machining aluminium and titanium alloys
BK6110	<ul style="list-style-type: none"> ▲ Carbide, TiCN-TiN-Al₂O₃-coated ▲ ISO P10 K10 ▲ Wear-resistant carbide grade for machining cast iron and steel materials 	BK7935	<ul style="list-style-type: none"> ▲ Carbide, AlTiN-coated ▲ ISO P35 M30 K30 N30 S30 O30 ▲ The tough carbide grade for machining stainless steel and acid-resistant steels as well as special alloys
BK6115	<ul style="list-style-type: none"> ▲ Carbide, TiCN-TiN-Al₂O₃-coated ▲ ISO P20 K20 H20 ▲ High-quality, surface-treated coating for machining cast iron materials in normal to stable conditions and at high cutting speeds 	BK8425	<ul style="list-style-type: none"> ▲ Carbide, TiAlN/TiN-coated ▲ ISO P25 M25 K25 ▲ Universal grade with greater wear resistance thanks to innovative PVD multi-layer coating
BK6440	<ul style="list-style-type: none"> ▲ Carbide, CVD-TiCN-Al₂O₃-TiN coated ▲ ISO M25 K35 ▲ Extremely tough standard grain grade; good wear resistance in steel and stainless steel materials, even in unfavourable cutting conditions / interrupted cut 	BK8430	<ul style="list-style-type: none"> ▲ Carbide, TiAlN/TiN-coated ▲ ISO P25 M25 ▲ Fine-grain grade with high wear resistance ▲ Extreme edge stability and maximum wear resistance in the middle and top speed range
		BK8440	<ul style="list-style-type: none"> ▲ Carbide, TiCN-TiN-coated ▲ ISO P35 M10 ▲ Very tough carbide grade for medium cutting speeds and interrupted cut

Type

<div style="border: 1px solid gray; padding: 5px; width: fit-content; margin-bottom: 20px;">CBN40</div> <ul style="list-style-type: none"> ▲ Cubic boron nitride, uncoated ▲ ISO H05 ▲ Uncoated cutting material made of cubic boron nitride for machining hardened steels over 45 HRC, heat-resistant nickel-based or cobalt-based alloys 	<div style="border: 1px solid gray; padding: 5px; width: fit-content; margin-bottom: 20px;">CWC06</div> <ul style="list-style-type: none"> ▲ Cermet, TiC/TiN-coated ▲ ISO P10 M10 K10 N10 ▲ Coated cermet grade for fine boring at high cutting speed and with a uniform cut
<div style="border: 1px solid gray; padding: 5px; width: fit-content; margin-bottom: 20px;">CK32</div> <ul style="list-style-type: none"> ▲ Cermet, uncoated ▲ ISO P10 M15 K05 N15 ▲ For fine and finish turning ▲ Less wear and greater cutting speed result in longer tool life and high surface quality ▲ Cutting material for high productivity in the top cutting speed range 	<div style="border: 1px solid gray; padding: 5px; width: fit-content; margin-bottom: 20px;">CWC10</div> <ul style="list-style-type: none"> ▲ Cermet, uncoated ▲ ISO P15 M10 K10 ▲ The uncoated cermet grade for finish machining of stainless and hardened steel ▲ Particularly wear-resistant due to high heat resistance
<div style="border: 1px solid gray; padding: 5px; width: fit-content; margin-bottom: 20px;">CK3230</div> <ul style="list-style-type: none"> ▲ Cermet, uncoated ▲ ISO P20 M20 K10 N20 ▲ Extremely tough behaviour with good wear resistance suitable for use also in interrupted cut 	<div style="border: 1px solid gray; padding: 5px; width: fit-content; margin-bottom: 20px;">CWN10</div> <ul style="list-style-type: none"> ▲ Carbide, TiN-coated ▲ ISO K10 ▲ The carbide grade for machining steels, stainless steels and non-ferrous metals
<div style="border: 1px solid gray; padding: 5px; width: fit-content; margin-bottom: 20px;">CTDPU20</div> <ul style="list-style-type: none"> ▲ Polycrystalline diamond cutting material with mixed grain, uncoated ▲ ISO N15 ▲ Outstanding wear resistance, even where Si content > 12 % and high proportion of abrasive reinforcements ▲ Used in plastics and fibre composites (GFK, CFK) 	<div style="border: 1px solid gray; padding: 5px; width: fit-content; margin-bottom: 20px;">CWP25</div> <ul style="list-style-type: none"> ▲ Carbide, uncoated ▲ ISO P25 M25 K25 N25 S25 ▲ Uncoated carbide grade for fine boring with large hole depths and small machining allowances

5

Coatings

<div style="border: 1px solid gray; padding: 5px; width: fit-content; margin-bottom: 20px;">TiN</div> <ul style="list-style-type: none"> ▲ TiN coating ▲ Maximum application temperature: 450 °C
--