

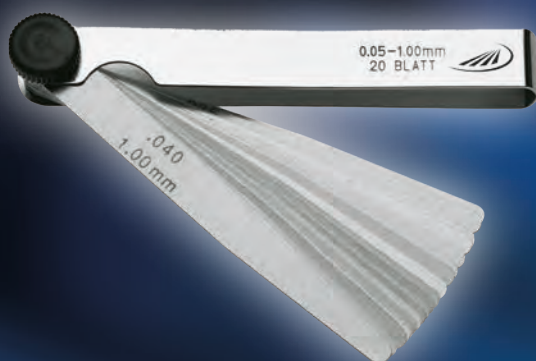

HELIOS · PREISSER

THE TRADE SPECIALISTS



# METROLOGY CATALOGUE



# METROLOGY CATALOGUE 2023 / 2024



Calipers



Dial gauges and Indicators



Micrometers



Bench centres



Plug gauges and  
Feeler gauge tapes

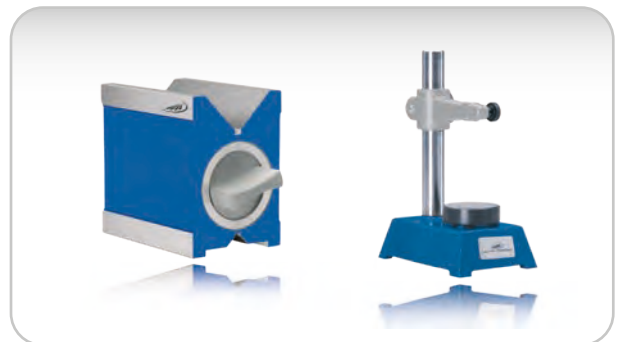

Inspection equipment



DIN & Locksmith squares

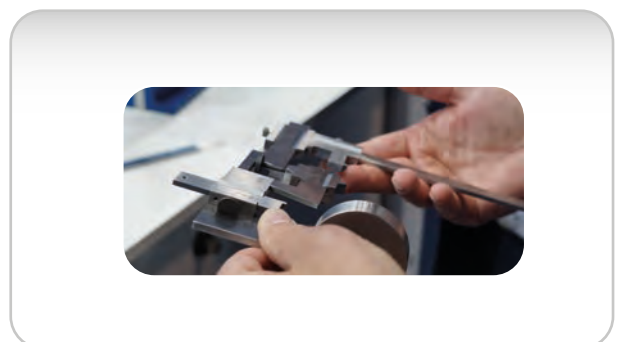

Custom-made products

## In Germany at home

In our new location in Gammertingen





„For more than 80 years,  
your reliable partner for  
everything about metrology“



HELIOS • PREISSER

Dear customers,

we are happy to present to you our new, revised catalogue 2023 with an updated range of measuring tools.

In this issue we are again offering the familiar wide and deep assortment of precise, high-quality measuring tools and inspection equipment, fitted to your requirements and demands.

As a strong and reliable partner, we are not only providing you with our comprehensive full-range offering but also with professional service and expert advice from our team in Gammertingen.

We would also like to bring your attention to the fact that we are still manufacturing individual, custom-made products for you at our new location in Gammertingen.

Challenge us, we are here for you.

Dustin Schmidt  
Head of Brand HELIOS-PREISSER



# SAMPLES CALIPER

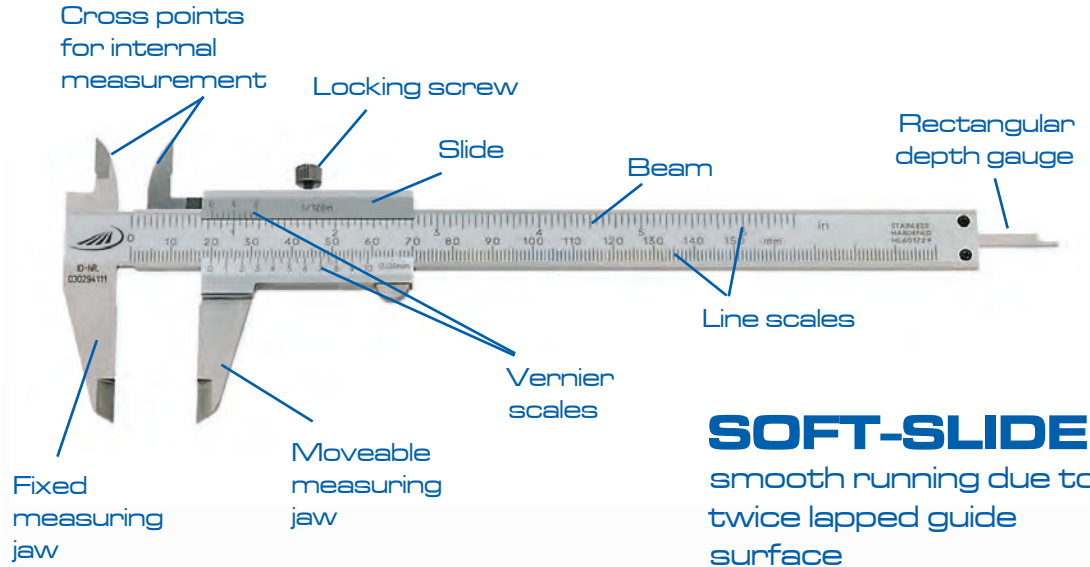

**SOFT-SLIDE**  
smooth running due to twice lapped guide surface

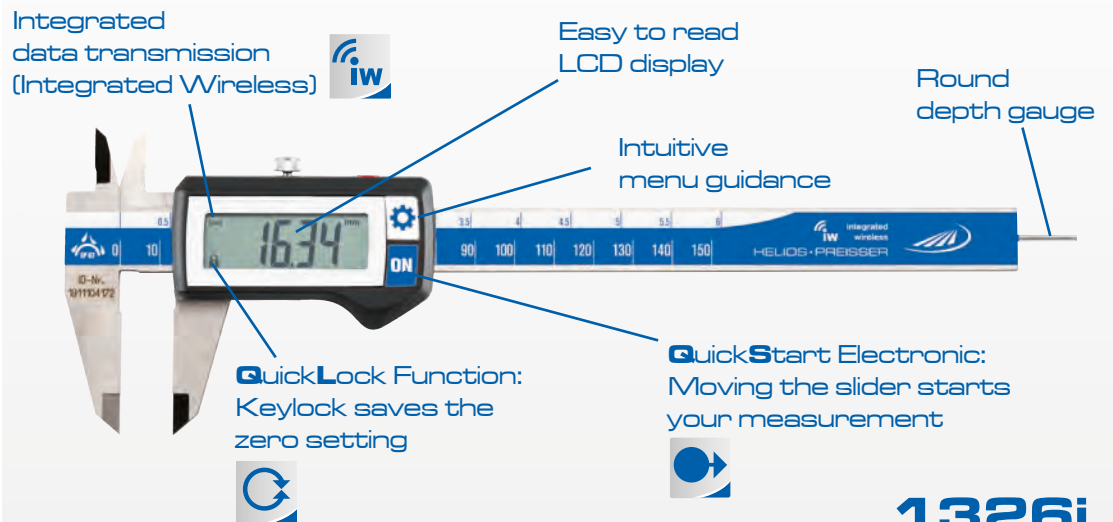

**1326i**  
with integrated wireless

## Possible application for **calipers**

### External measurement

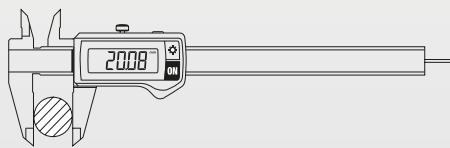

### Internal measurement

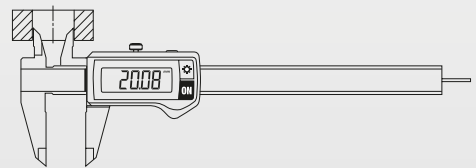

### Depth measurement

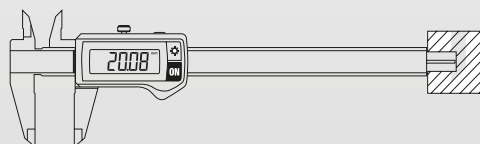

### Step (distance) measurement

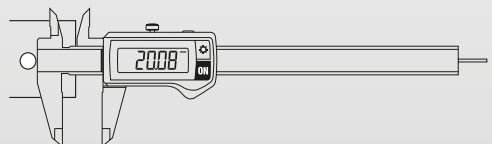

# 1. CHAPTER CALIPERS

8	Pocket vernier calipers
14	Pocket calipers / Tyre profile depth gauge
15	Pocket calipers with dial
16	Measuring tool sets
18	Digital pocket calipers
22	Universal calipers
24	Digital pocket calipers for specific measuring tasks
30	Vernier workshop calipers
38	Analogue caliper with cross points / gripper points
34	Digital workshop calipers
40	Calipers for external locking grooves
41	Calipers for internal locking grooves
42	Calipers for 3/5 point measurement / for milling tool setting
43	Chamfer / Radius gauges
44	Gear tooth calipers
45	Vernier depth gauges
48	Digital depth gauges
56	Steel gauge block inspection set for calipers
57	Wooden cases for calipers



## 0184 Pocket vernier calipers



ISO  
13385



### Model

- Stainless steel
- Reading parts have a satin chrome finish
- ISO 13385
- Inside cross points
- Low-set master scale
- Four way measurement
- Includes thread table

### Delivery

- Imitation leather case

✕	📏	Measuring range		Jaw length		Reading		Error limit	Depth gauge	Order no.	List price
		mm	inch	mm	inch	mm	inch	mm			EUR
<b>With thumb clamp</b>											
		0 - 150	0 - 6	40	1.6	0.05	1/128	0.05	rectangular	0184 501	29.40
		0 - 200	0 - 8	50	1.6	0.05	1/128	0.05	rectangular	0184 505	38.90
		0 - 300	0 - 12	60	2.0	0.05	1/128	0.05	none	0184 508	58.00

## 0185 Pocket vernier calipers



ISO  
13385



### Model

- Stainless steel
- Reading parts have a satin chrome finish
- ISO 13385
- Inside cross points
- Low-set master scale
- Four way measurement
- Includes thread table

### Delivery

- Imitation leather case

✕	📏	Measuring range		Jaw length		Reading		Error limit	Depth gauge	Order no.	List price
		mm	inch	mm	inch	mm	inch	mm			EUR
<b>With locking screw</b>											
		0 - 100	0 - 4	30	1.2	0.05	-	0.05	rectangular	0185 500	22.60
		0 - 150	0 - 6	40	1.6	0.05	1/128	0.05	rectangular	0185 501	29.40
		0 - 200	0 - 8	50	2.0	0.05	1/128	0.05	rectangular	0185 505	38.90
		0 - 300	0 - 12	60	2.4	0.05	1/128	0.05	none	0185 508	58.00
<b>With reading 0.02 mm</b>											
		0 - 150	0 - 6	40	1.6	0.02	0.001	0.03	rectangular	0185 50105	29.40
		0 - 200	0 - 8	50	2.0	0.02	0.001	0.03	rectangular	0185 50505	38.90





## 0188 / 0189 Pocket vernier calipers



ISO  
13385

1

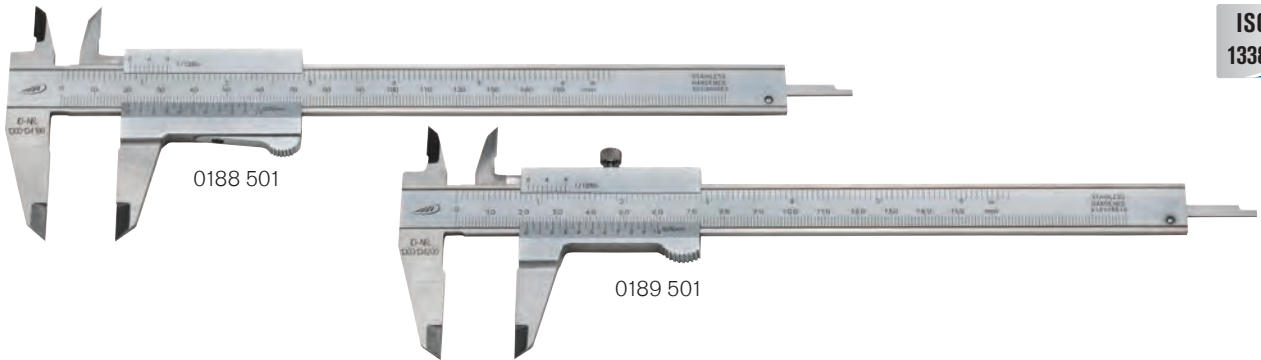

### Model

- Stainless steel
- Reading parts have a satin chrome finish
- ISO 13385
- Inside cross points
- Low-set master scale
- Four way measurement
- Includes thread table

### Delivery

- Imitation leather case

Icon	Measuring range		Jaw length		Reading		Error limit	Depth gauge	Order no.	List price
	mm	inch	mm	inch	mm	inch				
With thumb clamp	0 - 150	0 - 6	40	1.6	0.05	1/128	0.05	rectangular	0188 501	26.00
With locking screw	0 - 150	0 - 6	40	1.6	0.05	1/128	0.05	rectangular	0189 501	26.00

## 0194 / 0195 Pocket vernier calipers with round depth rod



ISO  
13385

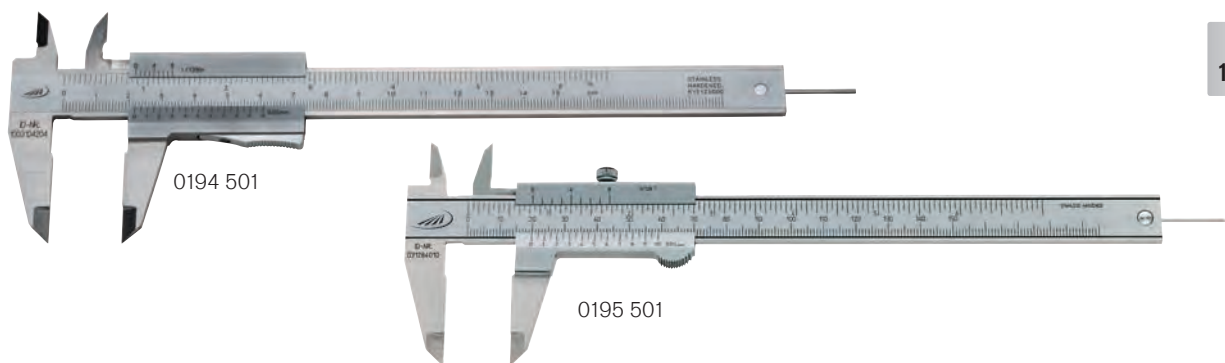

### Model

- Stainless steel
- Reading parts have a satin chrome finish
- ISO 13385
- Inside cross points
- Low-set master scale
- Four way measurement
- Includes thread table

### Delivery

- Imitation leather case

Icon	Measuring range		Jaw length		Reading		Error limit	Depth gauge	Order no.	List price
	mm	inch	mm	inch	mm	inch				
With thumb clamp	0 - 150	0 - 6	40	1.6	0.05	1/128	0.05	round 1.6	0194 501	30.50
With locking screw	0 - 150	0 - 6	40	1.6	0.05	1/128	0.05	round 1.6	0195 501	30.50



## 0196 Pocket vernier calipers with reading 0.02 mm



### Model

- Stainless steel
- Reading parts have a satin chrome finish
- ISO 13385
- Inside cross points
- Low-set master scale
- Four way measurement
- Includes thread table

### Delivery

- Imitation leather case

ISO  
13385

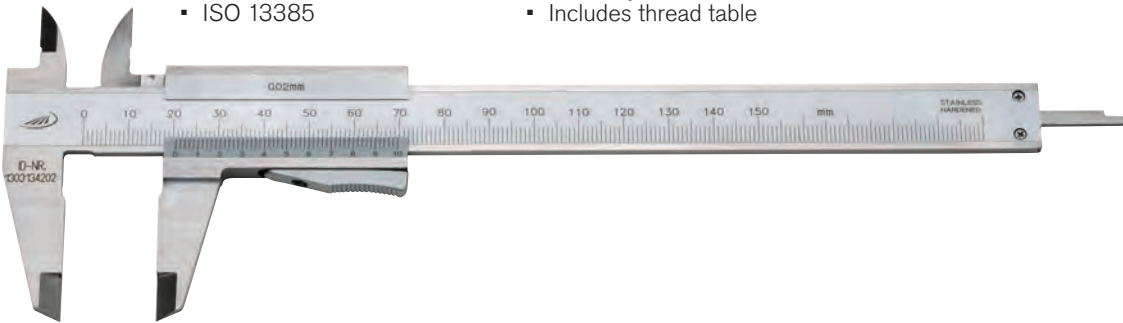

	Measuring range		Jaw length		Reading	Error limit	Depth gauge	Order no.	List price
	mm	inch	mm	inch					
With thumb clamp	0 - 150	0 - 6	40	1.6	0.02	0.03	rectangular	019650 105	28.30

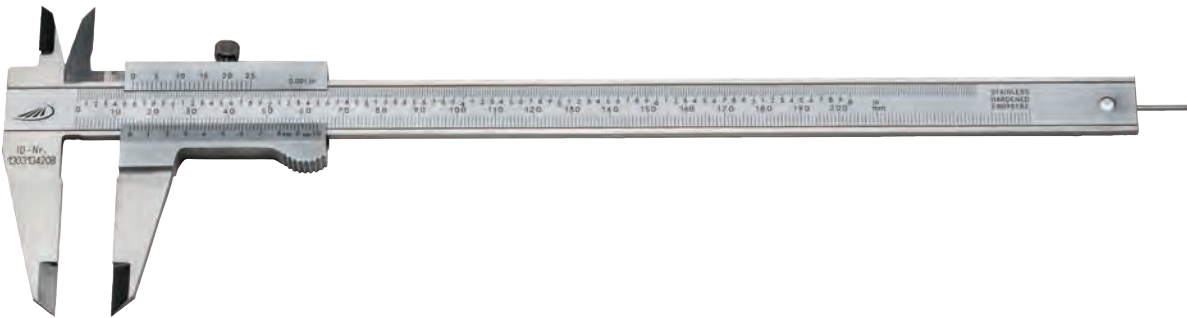

	Measuring range		Jaw length		Reading	Error limit	Depth gauge	Order no.	List price
	mm	inch	mm	inch					
With locking screw	0 - 200	0 - 8	40	2.0	0.02	0.03	round 1.6	019650 516	40.50



	Measuring range		Jaw length		Reading	Error limit	Depth gauge	Order no.	List price
	mm	inch	mm	inch					
With locking screw	0 - 150	0 - 6	40	1.6	0.02	0.03	rectangular	019650 116	28.30



## 0197 Pocket vernier calipers SOFT - SLIDE



ISO  
13385

1

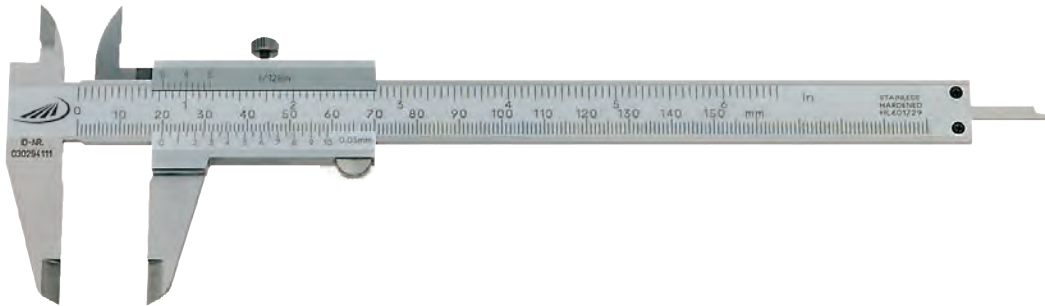

### Model

- Smooth running due to twice lapped guide surface
- Stainless steel
- Reading parts have a satin chrome finish

### Delivery

- ISO 13385
- Inside cross points
- Low-set master scale
- Four way measurement
- Includes thread table
- Imitation leather case

Icon	Measuring range		Jaw length		Error limit	Depth gauge	Order no.	List price
	mm	inch	mm	inch				
	0 - 150	0 - 6	40	1.6	0.05	rectangular	0197 501	37.20
	0 - 200	0 - 8	50	2.0	0.05	rectangular	0197 505	85.00
	0 - 300	0 - 12	60	2.4	0.05	none	0197 508	168.00

## 0198 / 0199 Pocket vernier calipers with parallax-free reading



ISO  
13385

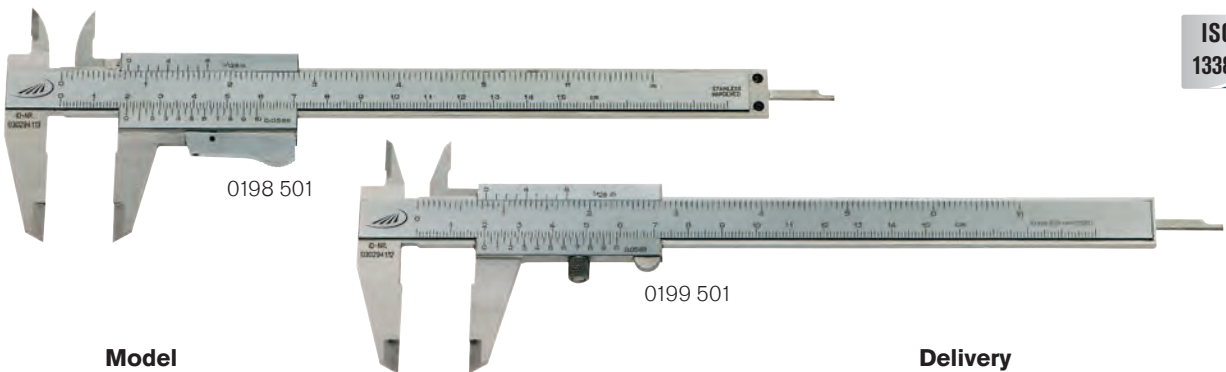

### Model

- **Parallax-free reading**
- Stainless steel
- Reading parts have a satin chrome finish
- ISO 13385

### Delivery

- Inside cross points
- Four way measurement
- Includes thread table
- Imitation leather case

Icon	Measuring range		Jaw length		Reading		Error limit	Depth gauge	Order no.	List price
	mm	inch	mm	inch	mm	inch				
<b>With thumb clamp</b>										
	0 - 150	0 - 6	40	1.6	0.05	1/128	0.05	rectangular	0198 501	34.40
<b>With locking screw</b>										
	0 - 150	0 - 6	40	1.6	0.05	1/128	0.05	rectangular	0199 501	34.40



## 0190 Pocket vernier caliper DUO-FIX



ISO  
13385

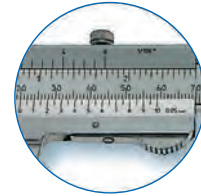
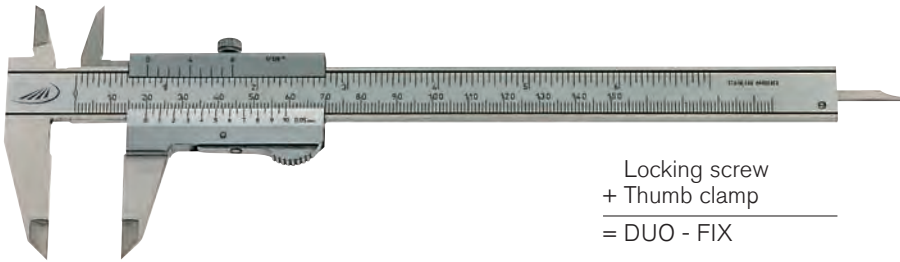

Locking screw  
+ Thumb clamp  
= DUO - FIX

### Model

- Stainless steel
- Reading parts have a satin chrome finish
- ISO 13385
- Thumb clamp **and** locking screw
- Inside cross points
- Low-set master scale
- Four way measurement
- Includes thread table

### Delivery

- Imitation leather case

Marked	Measuring range		Jaw length		Reading		Error limit	Depth gauge	Order no.	List price
	mm	inch	mm	inch	mm	inch				
	0 - 150	0 - 6	40	1.6	0.05	1/128	0.05	rectangular	0190 501	30.50

## 0203 Precision pocket vernier caliper PRISMA



ISO  
13385

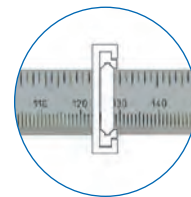

### Model

- **Parallax-free reading**
- **Double prisma guide with excellent sliding characteristics**
- Stainless steel
- Reading parts have a satin chrome finish
- ISO 13385
- Low-set locking screw
- Inside cross points
- Four way measurement
- Includes thread table

### Delivery

- Imitation leather case

Marked	Measuring range		Jaw length		Reading		Error limit	Depth gauge	Order no.	List price
	mm	inch	mm	inch	mm	inch				
	0 - 150	0 - 6	40	1.6	0.05	1/128	0.05	rectangular	0203 501	59.00



## 0182 Pocket vernier caliper for lefthanded

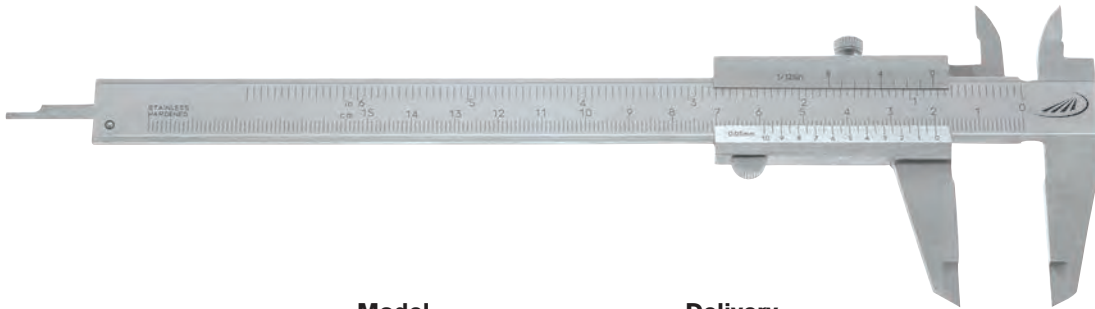

1

### Model

- Stainless steel
- Reading parts have a satin chrome finish
- Locking screw
- Factory standard

### Delivery

- Imitation leather case

☒ ☒	Measuring range		Jaw length		Reading		Error limit	Depth gauge	Order no.	List price
	mm	inch	mm	inch	mm	inch	mm			EUR
	0 - 150	0 - 6	40	1.6	0.05	1/128	0.05	rectangular	0182 501	38.90



## 0180 Pocket caliper



### Model

- Made from hard brass
- Factory standard

### Delivery

- Cardboard box

	Measuring range		Jaw length		Reading		Order no.	List price
	mm	inch	mm	inch	mm	inch		
	0 - 100	0 - 6	25	1.0	0.1	1/16	0180 320	EUR 8.10

## 0180 Pocket caliper



### Model

- Made from hard brass
- Stepped jaw 5 mm for internal measurement
- Factory standard

### Delivery

- Cardboard box

	Measuring range		Jaw length		Reading		Order no.	List price
	mm	inch	mm	inch	mm	inch		
	0 - 100	0 - 6	25	1.0	0.1	1/16	0180 330	EUR 8.10

## 0180 Tyre profile depth gauge



### Model

- Made from hard brass
- Factory standard

### Delivery

- Cardboard box

	Measuring range		Jaw length		Reading		Order no.	List price
	mm	inch	mm	inch	mm	inch		
	0 - 30	0 - 1.18	30	1.2	0.1	1/16	0180 310	EUR 5.00



## 0217 / 0218 Dial calipers



ISO  
13385

1



### Model

- Stainless steel
- Satin chrome scale
- ISO 13385
- Locking screw
- Inside cross points

### Delivery

- One pointer revolution with 0217 = 2 mm with 0218 = 1 mm
- Four way measurement
- Fitted case

✕	Measuring range		Jaw length		Reading	Error limit	Depth gauge	Order no.	List price EUR
	mm	inch	mm	inch	mm	mm			
▪	0 - 150	0 - 6	40	1.6	0.02	0.03	rectangular	0217 501	76.00
▪	0 - 200	0 - 8	40	1.6	0.02	0.03	rectangular	0217 502	153.00
▪	0 - 150	0 - 6	40	1.6	0.01	0.03	rectangular	0218 501	102.00



## 0212 Quality measuring tool set, 8 piece



### Content

- Pocket calipers DUO-FIX
- External micrometer with carbide measuring faces, measuring range 0-25 mm, reading 0.01 mm
- Flexible steel rule, stainless steel, measuring range 200 mm, graduation mm / mm, 13 x 0.5 mm
- Knife square, hardened, DIN 875/00, 100 x 70 mm, with non-glare knife edge
- Knife edge, hardened and ground, DIN 874/00, length 100 mm
- Scriber, carbide tipped, hexagonal handle made of one piece, with pocket clip, length 180 mm
- Radius gauge, special steel, 17 sheets, concave and convex, with locking nut, measuring range 1.0 – 7.0 mm
- Screw pitch gauge, combined metric ISO- and Whitworth thread, 48 blades, increments 0.4 – 7.0 / 4 – 62

### Shipment

- Wooden case

	Measuring range mm	Ablesung mm	Ablesung inch	Tiefenmaß mm	Best. Nr.	Listenpreis EUR
<b>Set mit Taschenmessschieber DUO - FIX (0190 501)</b>	0 - 150	0.05	1/128	rect.	0212 520	150.00





## DIGI-MET® QuickStart Electronic



1

### QuickStart-Electronic with the QuickLock-Function for only one zero setting

All digital calipers with the QuickStart-Electronic also have the **QuickLock** Function. Only set the zero position once, zero position remains stored for all further measurements. When the **QuickLock** Function is activated a lock symbol appears in the display, this ensures that the zero position is protected against any operating error caused by accidental usage of the operating keys (keys are locked). The caliper is immediately ready for measurement; once the caliper is switched ON or the slide is moved, the display is automatically activated.

The need to reset to zero as with a conventional caliper once it is switched on is obsolete.

### Conventional

- ① Switch ON
- ② Close the measuring jaws
- ③ Set to zero
- ④ Result of measurement

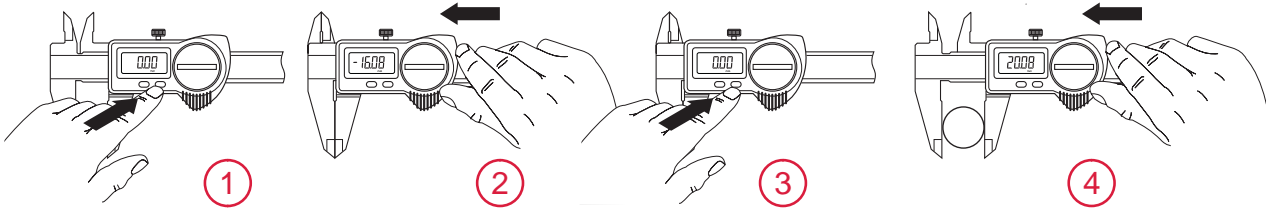

### QuickStart Electronic



Press the ON key or move the slide

## DIGI-MET® QuickLock-Function



- 1. Set to zero
- 2. Activate the QuickLock Function

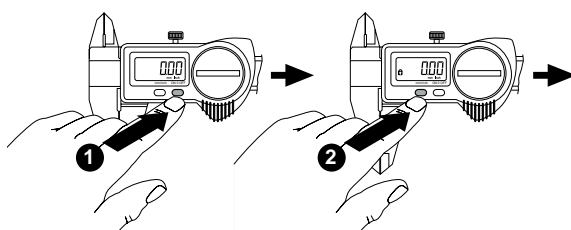

### Advantages of the QuickLock Function

- The caliper is immediately ready for measurement
- Lock symbol appears in the display. This ensures that the zero position is protected against any operating error caused by accidental usage of the operating keys (keys are locked)



## 1326i DIGI-MET® Pocket calipers IP67 with integrated wireless



1326 41660

## integrated IW wireless

Wireless Data Transmission



### Model

- Measuring system is insensitive to cooling agents and dust
- Protection class IP67
- Stainless steel
- LCD display 11 mm
- ISO 13385
- Housing and operating keys have an excellent chemical resistance
- Locking screw
- Inside cross points
- Four way measurements

### Functions

- ON / OFF
- **Quick-Start**
- **Quick-Lock** (key lock)
- Set to zero at any point
- mm / inch switching
- PRESET-Function (setting a numerical value)
- Integrated Wireless

### Delivery

- Plastic case

More information on our i-series and Integrated Wireless on page 224

✕	Measuring range		Jaw length		Reading		Error limit	Depth gauge	Order no.	List price
	mm	inch	mm	inch	mm	inch				
▪	0 - 150	0 - 6	40	1.6	0.01	.0005	0.03	round 1.5	1326 41660	246.00
▪	0 - 150	0 - 6	40	1.6	0.01	.0005	0.03	rectangular	1326 41760	246.00
▪	0 - 200	0 - 8	50	2.0	0.01	.0005	0.03	rectangular	1326 41860	315.00
▪	0 - 300	0 - 12	65	2.5	0.01	.0005	0.04	none	1326 42260	380.00



1998780

### Accessories

	Order no.	List price
i-Stick USB-receiver for Integrated Wireless	1998 780	108.00

Integrated Wireless is intended to be sold within the European Economic Area only



# HELIOS · PREISSER

## 1320 DIGI-MET® Pocket calipers



1320 416

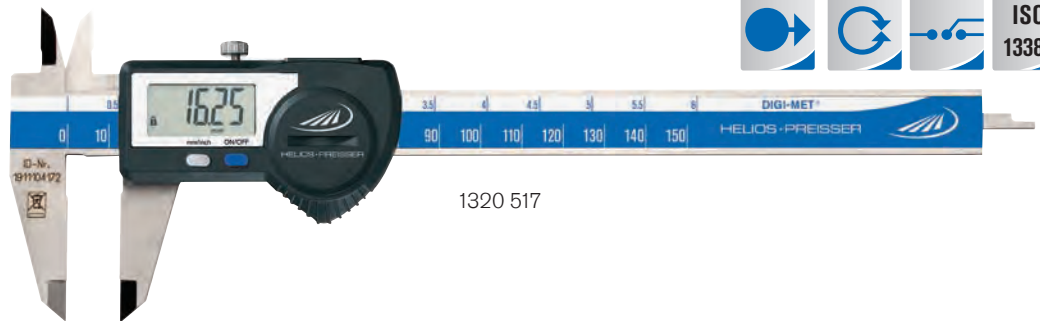

1320 517



### Model

- Inductive measuring system, resistant to moisture and sweat
- Stainless steel
- LCD display 11 mm without data output, 7.5 mm with data output
- ISO 13385
- Locking screw
- Inside cross points

- Four way measurement with measuring ranges 150 and 200 mm
- Three way measurement with measuring range 300 mm

### Functions

- ON / OFF
- **Quick-Start**
- **Quick-Lock** (key lock)
- Set to zero at any point
- mm / inch switching
- PRESET-Function (setting a numerical value 1320 4xx only)
- Variable data output RS 232 + Digimatic + USB (1320 5xx only)

### Delivery

- Plastic case

Icon	Measuring range		Jaw length		Reading		Error limit	Depth gauge	Order no.	List price EUR
	mm	inch	mm	inch	mm	inch				
<b>Without data output</b>										
▪	0 - 150	0 - 6	40	1.6	0.01	.0005	0.03	round 1.5	1320 416	130.00
▪	0 - 150	0 - 6	40	1.6	0.01	.0005	0.03	rectangular	1320 417	130.00
<b>With DATA VARIABLE</b>										
▪	0 - 150	0 - 6	40	1.6	0.01	.0005	0.03	round 1.5	1320 516	164.00
▪	0 - 150	0 - 6	40	1.6	0.01	.0005	0.03	rectangular	1320 517	164.00
▪	0 - 200	0 - 8	50	2.0	0.01	.0005	0.03	rectangular	1320 519	209.00
▪	0 - 300	0 - 12	65	2.5	0.01	.0005	0.04	none	1320 522	265.00
<b>With DATA VARIABLE, with extra long cross points (40 mm)</b>										
▪	0 - 150	0 - 6	40	1.6	0.01	.0005	0.03	round 1.5	1320 518	446.00

More information on 1320 518 on page 39



1998720

1998501

1997501

### Accessories

	Order no.	List price EUR
Data cable DATA VARIABLE to digimatic	1998 501	73.00
Data cable DATA VARIABLE to RS232	1997 501	57.00
Data cable DATA VARIABLE to USB	1998 720	82.00



## 1326 DIGI-MET® Pocket calipers IP67

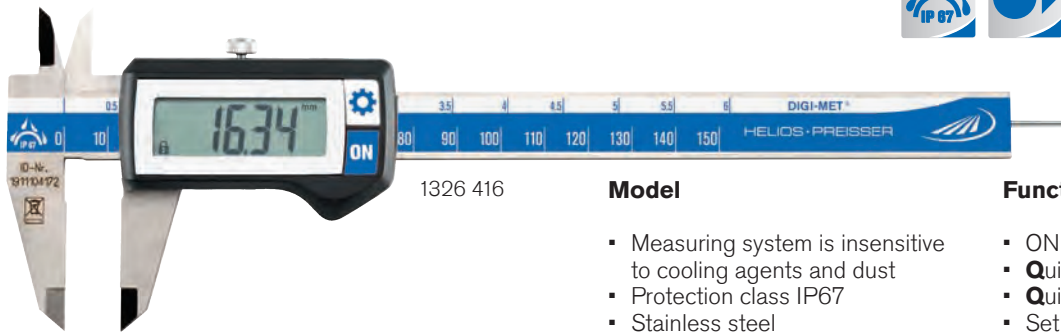

1326 416

### Model

- Measuring system is insensitive to cooling agents and dust
- Protection class IP67
- Stainless steel
- LCD display 11 mm
- ISO 13385
- Housing and operating keys have an excellent chemical resistance
- Locking screw
- Inside cross points
- Four way measurement with measuring ranges 150 and 200 mm
- Three way measurement with measuring range 300 mm

### Functions

- ON / OFF
- Quick-Start**
- Quick-Lock** (key lock)
- Set to zero at any point
- mm / inch switching
- PRESET-Function (setting a numerical value)

### Delivery

- Plastic case

Marked	Measuring range		Jaw length		Reading		Error limit	Depth gauge	Order no.	List price
	mm	inch	mm	inch	mm	inch				
▪	0 - 150	0 - 6	40	1.6	0.01	.0005	0.03	round 1.5	1326 416	180.00
▪	0 - 150	0 - 6	40	1.6	0.01	.0005	0.03	rectangular	1326 417	180.00
▪	0 - 200	0 - 8	50	2.0	0.01	.0005	0.03	rectangular	1326 418	254.00
▪	0 - 300	0 - 12	65	2.5	0.01	.0005	0.04	none	1326 422	322.00
<b>With carbide-tipped measuring jaws</b>										
▪	0 - 150	0 - 6	40	1.6	0.01	.0005	0.03	round 1.5	1326 914	387.00

## 0220 Additional depth measuring base

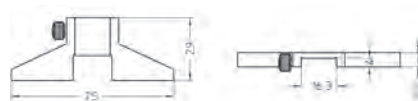

### Model

- Stainless steel
- Bridge length: 75 mm
- Dimensions: 75 x 6.5 mm

Marked	Order no.	List price
	0220 705	25.30



# HELIOS · PREISSER

## 1326 DIGI-MET® Pocket calipers IP67 with data output



1

### Model

- Measuring system is insensitive to cooling agents and dust
- Protection class IP67
- Stainless steel
- LCD display 7,5 mm
- ISO 13385
- Locking screw
- Inside cross points
- Four way measurement

### Functions

- ON / OFF
- **Quick-Start**
- **Quick-Lock** (key lock)
- Set to zero at any point
- mm / inch switching
- Variable data output RS 232 + Digimatic + USB

### Delivery

- Plastic case

✕	Measuring range		Jaw length		Reading		Error limit	Depth gauge	Order no.	List price
	mm	inch	mm	inch	mm	inch	mm			EUR
▪	0 - 150	0 - 6	40	1.6	0.01	.0005	0.03	round 1.5	1326 516	180.00
▪	0 - 150	0 - 6	40	1.6	0.01	.0005	0.03	rectangular	1326 517	180.00
▪	0 - 200	0 - 8	50	2.0	0.01	.0005	0.03	rectangular	1326 518	265.00



### Accessories

	Order no.	List price
		EUR
Data cable DATA VARIABLE to RS232	1997 501	57.00
Data cable DATA VARIABLE to digimatic	1998 501	73.00
Data cable DATA VARIABLE to USB	1998 720	82.00



## 1348 DIGI-MET® Universal calipers

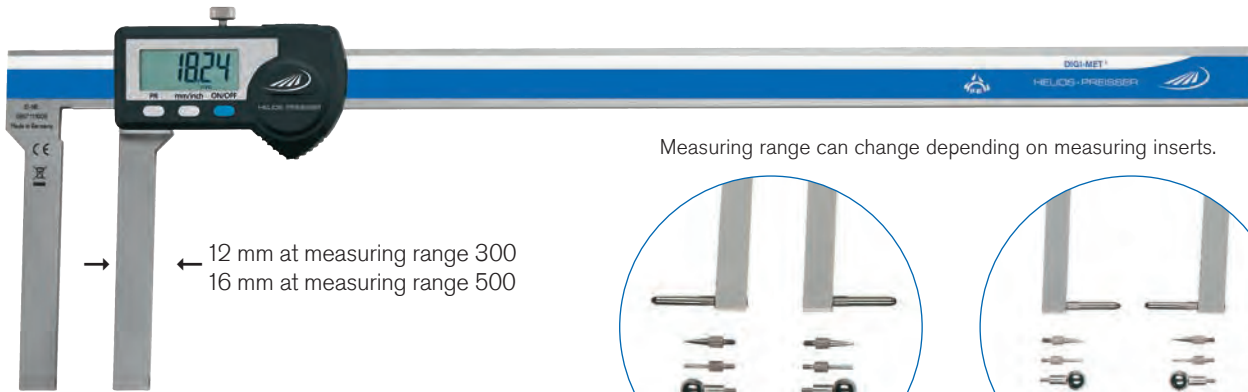

→ ← 12 mm at measuring range 300  
16 mm at measuring range 500

Measuring range can change depending on measuring inserts.

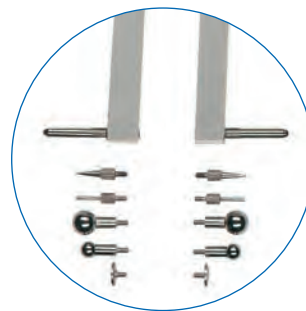

for internal measurements



for external measurements

### Model

- Stainless steel
- Factory standard
- Protection class IP65
- LCD display 10 or 12.5 mm
- Locking screw
- For internal and external measurements
- Individually adaptable on problematic tasks through measuring inserts with thread M 2.5

### Functions

- ON / OFF
- **Quick-Start**
- **Quick-Lock** (key lock)
- Set to zero at any point
- mm / inch switching
- **PRESET-Function** (setting a numerical value)
- Variable data output RS 232 + Digimatic + USB

### Delivery

- 300 mm measuring range in plastic case
- 500 mm measuring range in wooden case
- Without measuring inserts ([correct measuring inserts with thread M 2.5, see pages 108-111](#))

✕	Measuring range		Jaw length		Reading		Error limit	Order no.	List price
	mm	inch	mm	inch	mm	inch	mm		EUR
	0 - 300	0 - 12	90	3.5	0.01	.0005	0.06	1348 722	685.00
	0 - 500	0 - 20	100	4.0	0.01	.0005	0.08	1348 728	877.00



1998720    1998501    1997501

### Accessories

	Order no.	List price
Data cable DATA VARIABLE to RS232	1997 501	57.00
Data cable DATA VARIABLE to digimatic	1998 501	73.00
Data cable DATA VARIABLE to USB	1998 720	82.00



# HELIOS · PREISSER

## 1326 Universal pocket caliper „Pocket Talent“

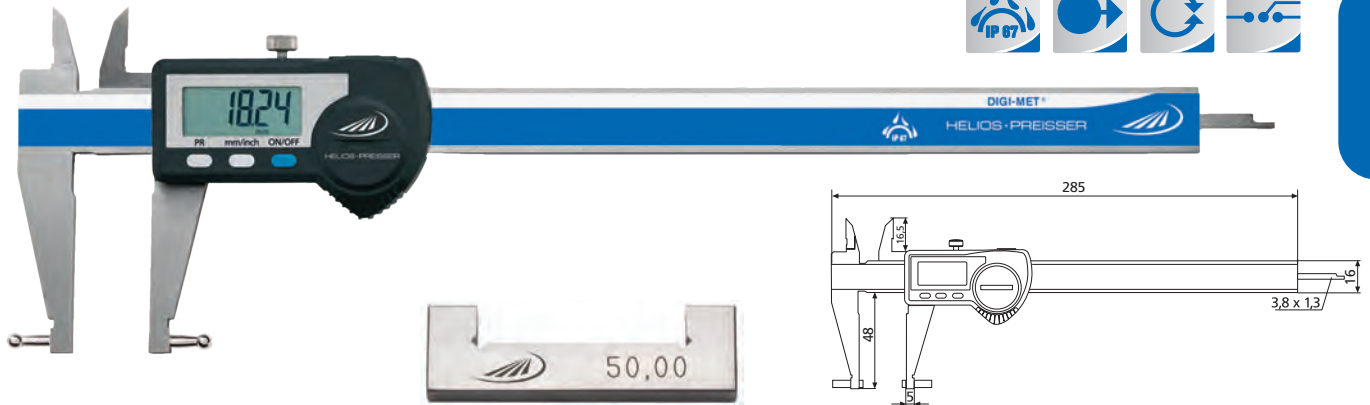

1

Incl. setting standard

### Model

- Stainless steel
- Protection class IP67
- Factory standard
- LCD display 7.5 mm
- Locking screw
- For internal and external measurements
- Individually adaptable on problematic tasks through measuring inserts with thread M 2.5

### Functions

- ON / OFF
- **Quick-Start**
- **Quick-Lock** (key lock)
- Set to zero at any point
- mm / inch switching
- PRESET-Function (setting a numerical value)
- Variable data output RS 232 + Digimatic + USB

### Delivery

- Plastic case
- Measuring inserts No. 0710161\* and 0710177\*  
Planar surface Ø 4.8 mm /  
Ball inserts Ø 5.0 mm
- Setting standard 50 mm

Icon	Measuring range		Jaw length	Reading		Order no.	List price
	mm	inch		mm	mm		
	0 - 200	0 - 8	48	0.01	.0005	1326 932	405.00

Our all-round talent can be combined with all common types of measuring inserts for indicators with a standard M 2.5 thread. This way, the Pocket Talent offers you various solutions for numerous measurement applications.

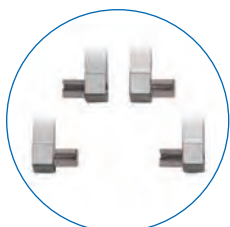

0710161\*

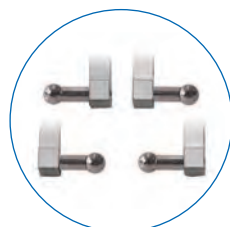

0710177\*

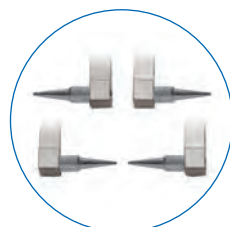

0710166

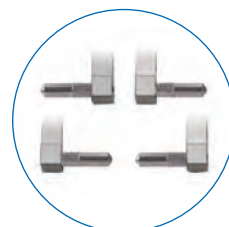

0710167

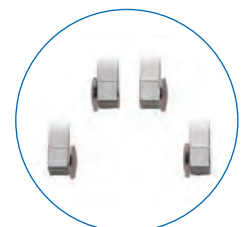

0710163



1998720



1998501



1997501

### Accessories

	Order no.	List price
		EUR
Measuring inserts M 2.5	0710 161	4.90
Measuring inserts M 2.5	0710 163	7.40
Measuring inserts M 2.5	0710 166	6.70
Measuring inserts M 2.5	0710 167	4.70
Measuring inserts M 2.5	0710 177	9.30
Setting standard for Pocket Talent	1326 990	44.00
Data cable DATA VARIABLE to RS232	1997 501	57.00
Data cable DATA VARIABLE to digimatic	1998 501	73.00
Data cable DATA VARIABLE to USB	1998 720	82.00



## 1326 DIGI-MET® Pocket calipers for specific measuring tasks

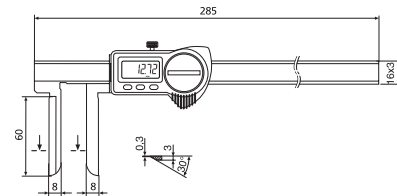
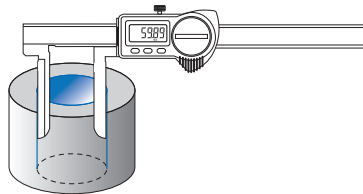
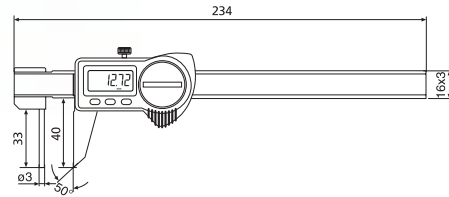
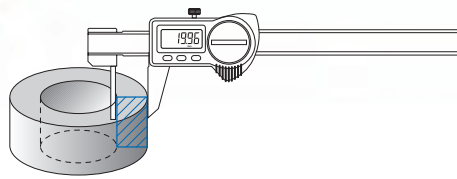

### Model

- Protection class IP67
- Stainless steel
- LCD display 7.5 mm
- Factory standard
- Measuring system is insensitive to cooling agents and dust

- Housing and operating keys have an excellent chemical resistance
- Inside cross points
- Locking screw

### Functions

- ON / OFF
- Quick-Start
- Quick-Lock (key lock)
- Set to zero at any point
- mm / inch switching
- PRESET-Function (setting a numerical value)
- Variable data output RS 232 + Digimatic + USB

### Delivery

- Plastic case

	Measuring range		Jaw length		Reading		Order no.	List price EUR
	mm	inch	mm	inch	mm	inch		
<b>Wall thickness caliper</b>	0 - 150	0 - 6	40	1.6	0.01	.0005	1326 918	567.00
<b>With long cross jaws for inner measurements</b>	10 - 200	0.4 - 8	60	2.4	0.01	.0005	1326 930	736.00

### Accessories



1998720

1997501

1998501

Data cable DATA VARIABLE to RS232

Order no.

1997 501

List price  
EUR

57.00

Data cable DATA VARIABLE to digimatic

1998 501

73.00

Data cable DATA VARIABLE to USB

1998 720

82.00





# HELIOS · PREISSER

## 1326 DIGI-MET® Pocket calipers for specific measuring tasks

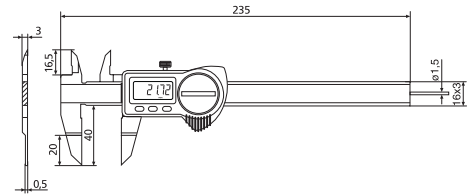
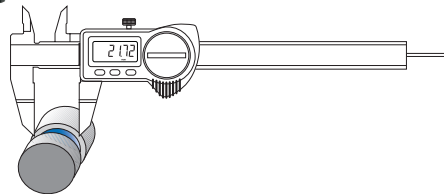
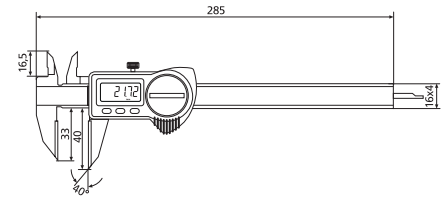
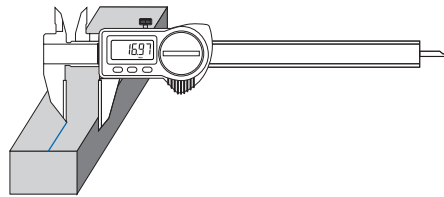
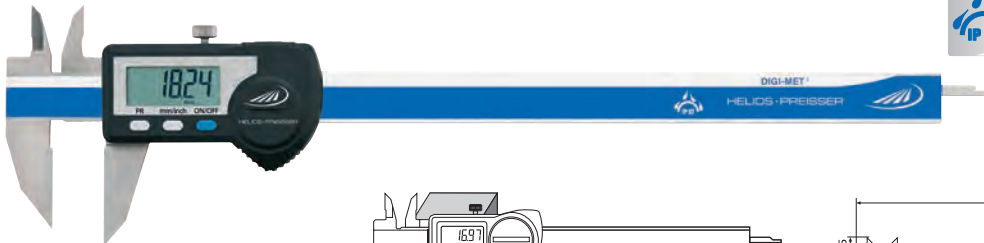

### Model

- Protection class IP67
- Stainless steel
- LCD display 7,5 mm
- Factory standard
- Measuring system is insensitive to cooling agents and dust

- Housing and operating keys have an excellent chemical resistance
- Inside cross points
- Locking screw

### Functions

- ON / OFF
- Quick-Start
- Quick-Lock (key lock)
- Set to zero at any point
- mm / inch switching
- PRESET-Function (setting a numerical value)
- Variable data output RS 232 + Digimatic + USB

### Delivery

- Plastic case

Icon	Measuring range		Jaw length		Reading		Depth gauge	Order no.	List price EUR
	mm	inch	mm	inch	mm	inch			
<b>Scribing caliper with carbide-tipped outer measuring surfaces</b>									
	0 - 200	0 - 8	33	1.3	0.01	.0005	rectangular	1326 912	361.00
<b>With flat measuring surfaces e.g. for outer recesses</b>									
	0 - 150	0 - 6	40	1.6	0.01	.0005	round 1.5	1326 920	615.00

### Accessories



1998720

1997501

1998501

	Order no.	List price EUR
Data cable DATA VARIABLE to RS232	1997 501	57.00
Data cable DATA VARIABLE to digimatic	1998 501	73.00
Data cable DATA VARIABLE to USB	1998 720	82.00



## 1326 DIGI-MET® Pocket calipers for specific measuring tasks

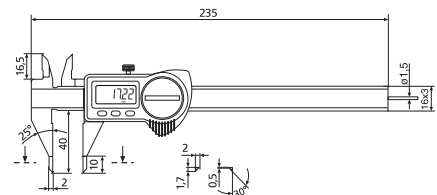
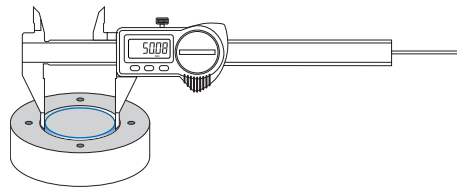
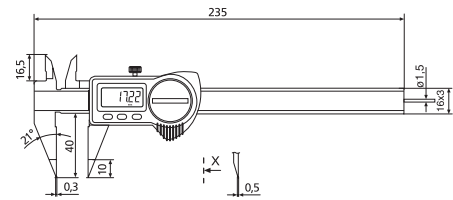
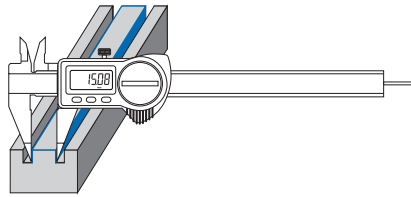

### Model

- Protection class IP67
- Stainless steel
- LCD display 7.5 mm
- Factory standard
- Measuring system is insensitive to cooling agents and dust

- Housing and operating keys have an excellent chemical resistance
- Inside cross points
- Locking screw

### Functions

- ON / OFF
- **Quick-Start**
- **Quick-Lock** (key lock)
- Set to zero at any point
- mm / inch switching
- PRESET-Function (setting a numerical value)
- Variable data output RS 232 + Digimatic + USB

### Delivery

- Plastic case

Icon	Measuring range		Jaw length		Reading		Order no.	List price EUR
	mm	inch	mm	inch	mm	inch		
	With pointed jaws							
	0 - 150	0 - 6	40	1.6	0.01	.0005	1326 916	447.00
	With fine measuring tips							
	0 - 150	0 - 6	40	1.6	0.01	.0005	1326 922	504.00



1998720

1998501

1997501

### Accessories

	Order no.	List price EUR
Data cable DATA VARIABLE to RS232	1997 501	57.00
Data cable DATA VARIABLE to digimatic	1998 501	73.00
Data cable DATA VARIABLE to USB	1998 720	82.00



# HELIOS · PREISSER

## 1326 DIGI-MET® Pocket calipers for specific measuring tasks



1

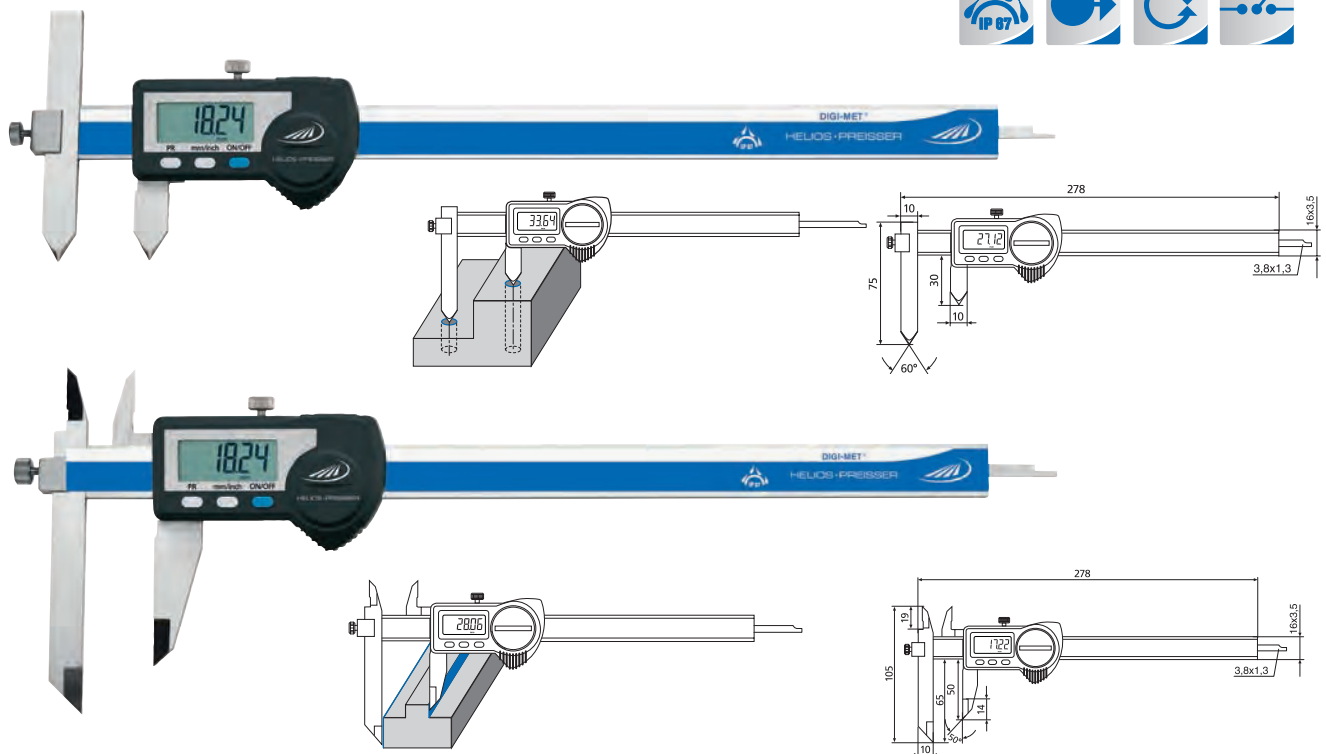

### Model

- Protection class IP67
- Stainless steel
- LCD display 7.5 mm
- Factory standard
- Measuring system is insensitive to cooling agents and dust

- Housing and operating keys have an excellent chemical resistance
- Inside cross points
- Locking screw

### Functions

- ON / OFF
- Quick-Start
- Quick-Lock (key lock)
- Set to zero at any point
- mm / inch switching
- PRESET-Function (setting a numerical value)
- Variable data output RS 232 + Digimatic + USB

### Delivery

- Plastic case

Icon	Measuring range		Jaw length		Reading		Order no.	List price EUR
	mm	inch	mm	inch	mm	inch		
	<b>Moving jaws for measuring the distance between bores</b>							
	10 - 210	0.4 - 8.3	75	3.0	0.01	.0005	1326 924	500.00
	<b>Moving jaws + cross tips</b>							
	0 - 200	0 - 8	65	2.5	0.01	.0005	1326 928	537.00



1998720

1998501

1997501

### Accessories

	Order no.	List price EUR
Data cable DATA VARIABLE to RS232	1997 501	57.00
Data cable DATA VARIABLE to digimatic	1998 501	73.00
Data cable DATA VARIABLE to USB	1998 720	82.00



## 1326 DIGI-MET® Pocket calipers for specific measuring tasks

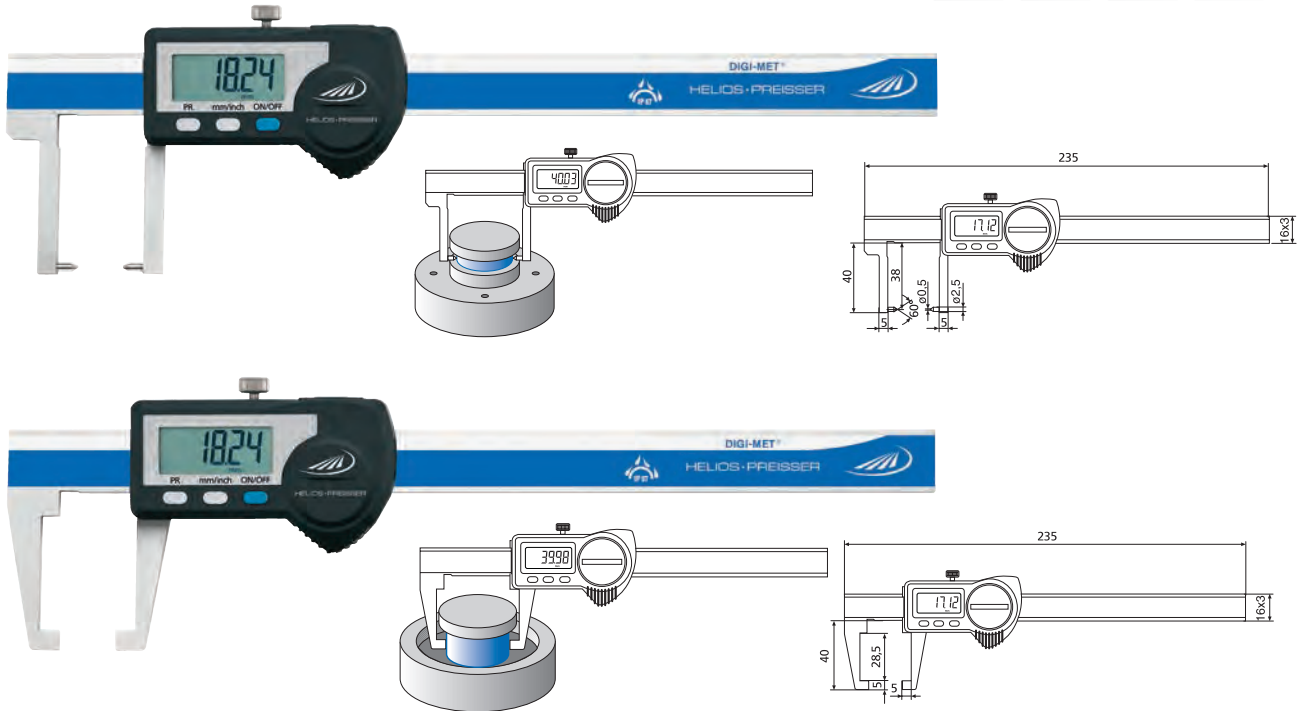

### Model

- Protection class IP67
- Stainless steel
- LCD display 7.5 mm
- Factory standard
- Measuring system is insensitive to cooling agents and dust

- Housing and operating keys have an excellent chemical resistance
- Inside cross points
- Locking screw

### Functions

- ON / OFF
- Quick-Start
- Quick-Lock (key lock)
- Set to zero at any point
- mm / inch switching
- PRESET-Function (setting a numerical value)
- Variable data output RS 232 + Digimatic + USB

### Delivery

- Plastic case

Measuring tips angled inwards	Measuring range		Jaw length		Reading		Order no.	List price EUR
	mm	inch	mm	inch	mm	inch		
	0 - 140	0 - 5,5	40	1.6	0.01	.0005	1326 904	646.00
Measuring jaws angled inwards	0 - 150	0 - 6	40	1.6	0.01	.0005	1326 908	552.00

### Accessories



1998720

1997501

1998501

- data cable DATA VARIABLE to RS232
- data cable DATA VARIABLE to digimatic
- data cable DATA VARIABLE to USB

### Order no.

### List price EUR

1997 501

57.00

1998 501

73.00

1998 720

82.00



# HELIOS · PREISSER

## 1326 DIGI-MET® Pocket calipers for specific measuring tasks



### Model

- Protection class IP67
- Stainless steel
- LCD display 7.5 mm
- Factory standard
- Measuring system is insensitive to cooling agents and dust

- Housing and operating keys have an excellent chemical resistance
- Inside cross points
- Locking screw

### Functions

- ON / OFF
- Quick-Start
- Quick-Lock (key lock)
- Set to zero at any point
- mm / inch switching
- PRESET-Function (setting a numerical value)
- Variable data output RS 232 + Digimatic + USB

### Delivery

- Plastic case

Measuring range	Measuring range		Jaw length		Reading		Order no.	List price EUR
	mm	inch	mm	inch	mm	inch		
<b>Measuring tips angled outwards</b>								
	20 - 170	0.8 - 6.7	40	1.6	0.01	.0005	1326 906	641.00
<b>Measuring jaws angled outwards</b>								
	10 - 160	0.4 - 6.7	40	1.6	0.01	.0005	1326 910	634.00

### Accessories



1998720      1997501      1998501

Accessories	Order no.	List price EUR
Data cable DATA VARIABLE to RS232	1997 501	57.00
Data cable DATA VARIABLE to digimatic	1998 501	73.00
Data cable DATA VARIABLE to USB	1998 720	82.00



## 0234 / 0235 Workshop calipers



ISO  
13385



0234 503



0235 503

### Model

- Stainless steel
- Vernier and reading parts have a satin chrome finish
- ISO 13385
- Factory standard from 1500 mm measuring range
- Locking screw
- Knife points
- Stepped jaws for inside measurement: 10 mm, 20 mm\* and 30 mm\*\*
- Low-set master scale
- High-precision laser graduation on vernier and scale

### Delivery

- 300 mm Measuring range in plastic case
- From 500 mm measuring range in carton

⌘	📏	Measuring range		Jaw length		Reading		Error limit mm	Order no.	List price EUR
		mm	inch	mm	inch	mm	inch			
<b>Without fine adjustment</b>										
▪		0 - 300	0 - 12	90	3.5	0.05	1/128	0.05	0234 503	185.00
▪		0 - 500	0 - 20	150	6.0	0.05		0.07	0234 508*	552.00
▪		0 - 800	0 - 31	150	6.0	0.05		0.1	0234 514*	708.00
▪		0 - 1000	0 - 39	150	6.0	0.05		0.12	0234 518*	850.00
	▪	0 - 1500	0 - 59	200	8.0	0.05		0.18	0234 524**	1787.00
	▪	0 - 2000	0 - 79	200	8.0	0.05		0.22	0234 526**	2616.00
<b>With fine adjustment</b>										
▪		0 - 300	0 - 12	90	3.5	0.05	1/128	0.05	0235 503	214.00
▪		0 - 500	0 - 20	150	6.0	0.05		0.07	0235 508*	596.00
▪		0 - 800	0 - 31	150	6.0	0.05		0.1	0235 514*	780.00
▪		0 - 1000	0 - 39	150	6.0	0.05		0.12	0235 518*	921.00
	▪	0 - 1500	0 - 59	200	8.0	0.05		0.18	0235 524**	1895.00



## 0236 / 0237 Workshop calipers



ISO  
13385

1

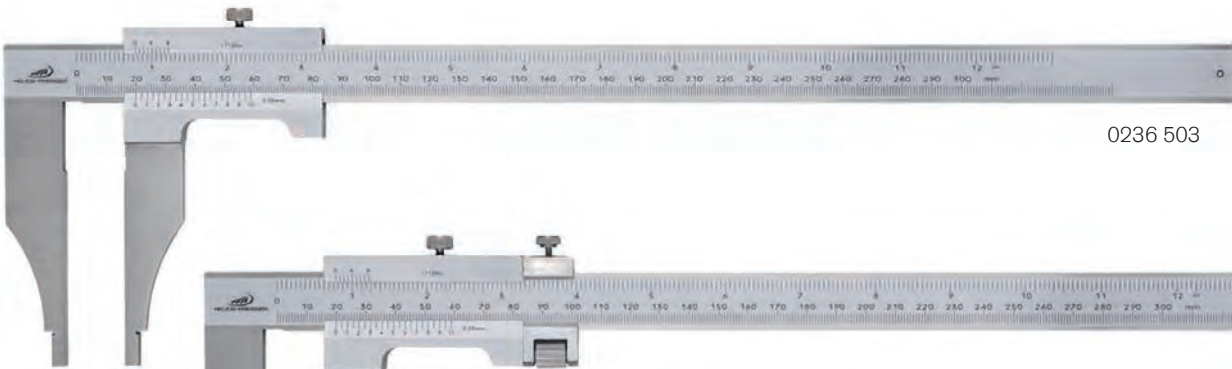

0236 503

0237 503

### Model

- Stainless steel
- Vernier and reading parts have a satin chrome finish
- ISO 13385
- Factory standard from 1500 mm measuring range
- Locking screw

- Fine adjustment
- Low-set master scale
- Stepped jaws for inside measurement: 10 mm, 20 mm\*, 30 mm\*\* and 50 mm
- High-precision laser graduation on vernier and scale

### Delivery

- 300 mm Measuring range in plastic case
- From 500 mm measuring range in carton

Icon	Measuring range		Jaw length		Reading		Error limit	Order no.	List price	
	mm	inch	mm	inch	mm	inch				mm
<b>Without fine adjustment</b>										
▪	0 - 300	0 - 12	90	3.5	0.05	1/128	0.05	0236 503	165.00	
▪	0 - 500	0 - 20	150	6.0	0.05		0.07	0236 508*	459.00	
▪	0 - 800	0 - 31	150	6.0	0.05		0.1	0236 514*	569.00	
▪	0 - 1000	0 - 39	150	6.0	0.05		0.12	0236 518**	709.00	
<b>With fine adjustment</b>										
▪	0 - 300	0 - 12	90	3.5	0.05	1/128	0.05	0237 503	197.00	
▪	0 - 500	0 - 20	150	6.0	0.05		0.07	0237 508*	516.00	
▪	0 - 800	0 - 31	150	6.0	0.05		0.1	0237 514*	640.00	
▪	0 - 1000	0 - 39	150	6.0	0.05		0.12	0237 518*	782.00	
▪	0 - 1500	0 - 59	200	8.0	0.05		0.18	0237 524**	1673.00	
▪	0 - 2000	0 - 79	200	8.0	0.05		0.22	0237 526**	2535.00	



## 0236 / 0237 Workshop calipers with long measuring jaws

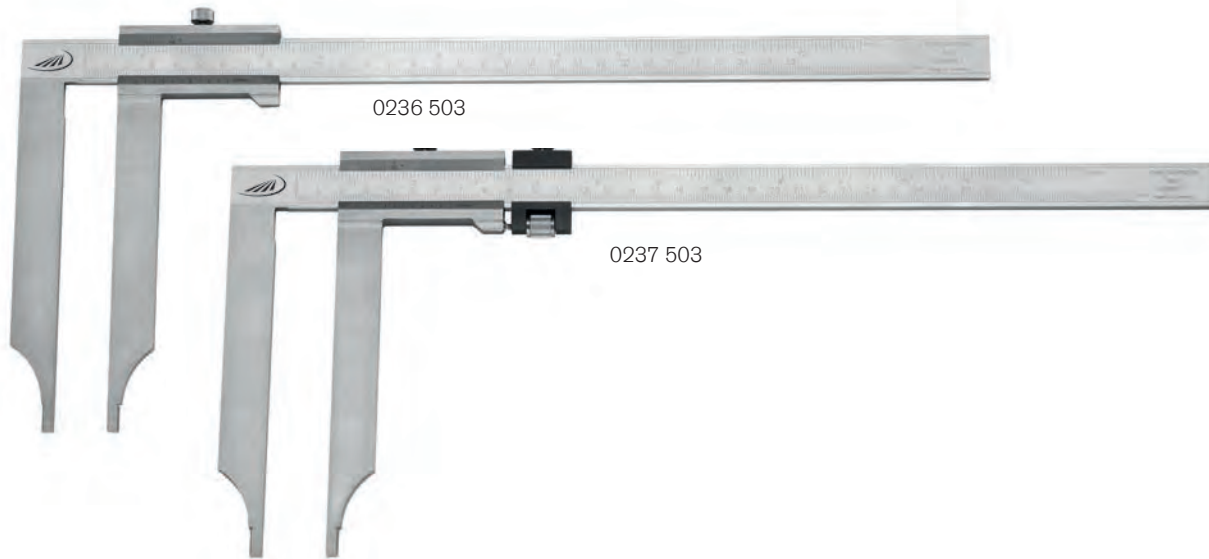

### Model

- Stainless steel
- Vernier and reading parts have a satin chrome finish
- Factory standard
- Locking screw
- Low-set master scale
- Stepped jaws for inside measurement: 10 mm, 20 mm\*, 30 mm\*\* and 50 mm
- High-precision laser graduation on vernier and scale

### Delivery

- Carton

	Measuring range		Jaw length		Reading		Error limit mm	Order no.	List price EUR	
	mm	inch	mm	inch	mm	inch				
<b>Without fine adjustment</b>										
	0 - 300	12	150	6.0	0.05	1/128	0.1	0236 504	291.00	
	0 - 500	20	200	8.0	0.05		0.14	0236 509*	605.00	
	0 - 500	20	300	12.0	0.05		0.14	0236 510*	722.00	
	0 - 800	31	300	12.0	0.05		0.2	0236 516*	1121.00	
	0 - 1000	39	300	12.0	0.05		0.24	0236 520*	1360.00	
▪	0 - 1500	59	300	12.0	0.05		0.36	0236 525**	1907.00	
▪	0 - 2000	79	300	12.0	0.05		0.44	0236 527**	2825.00	
<b>With fine adjustment</b>										
	0 - 300	0 - 12	150	6.0	0.05	1/128	0.1	0237 504	319.00	
	0 - 500	0 - 20	300	12.0	0.05		0.14	0237 510*	779.00	
	0 - 800	0 - 31	300	12.0	0.05		0.2	0237 516*	1189.00	
	0 - 1000	0 - 39	300	12.0	0.05		0.24	0237 520*	1431.00	
	0 - 1000	0 - 39	500	20.0	0.05		0.24	0237 521**	1931.00	
▪	0 - 1500	0 - 59	300	12.0	0.05		0.36	0237 525**	2020.00	





## 0230 / 0231 Workshop calipers with parallax-free reading



ISO  
13385

1

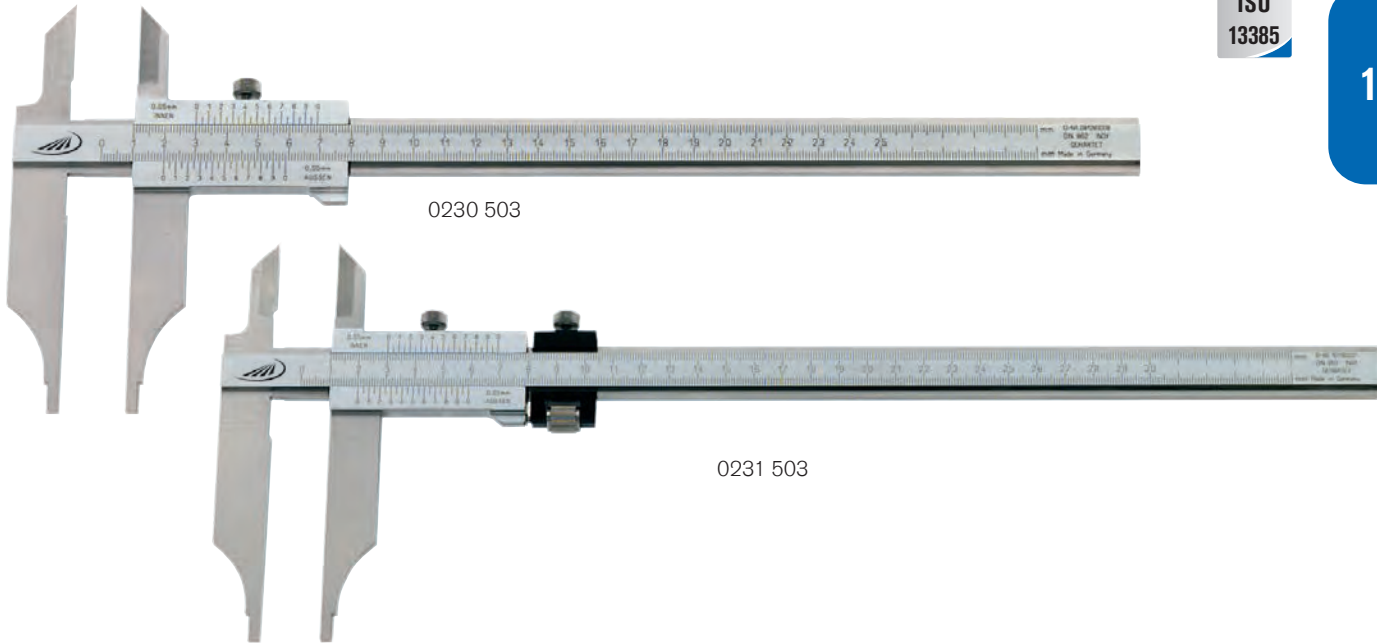

### Model

- **Parallax-free reading**
- Stainless steel
- Reading parts have a satin chrome finish
- ISO 13385
- Locking screw
- Knife points
- Stepped jaws for inside measurement: 10 mm, for measuring range 500 mm: 20 mm
- Direct reading of internal and external measurements
- High-precision laser graduation on vernier and scale

### Delivery

- 300 mm Measuring range in plastic case
- From 500 mm measuring range in carton

	Measuring range		Jaw length		Reading	Error limit	Order no.	List price
	mm	inch	mm	inch				
<b>Without fine adjustment</b>								
▪	0 - 300	0 - 12	90	3.5	0.05	0.05	0230 503	201.00
▪	0 - 500	0 - 20	150	6.0	0.05	0.07	0230 508	575.00
<b>With fine adjustment</b>								
▪	0 - 300	0 - 12	90	3.5	0.05	0.05	0231 503	232.00
▪	0 - 500	0 - 20	150	6.0	0.05	0.07	0231 508	628.00



## 1330 / 1331 DIGI-MET® Workshop calipers



1330 522

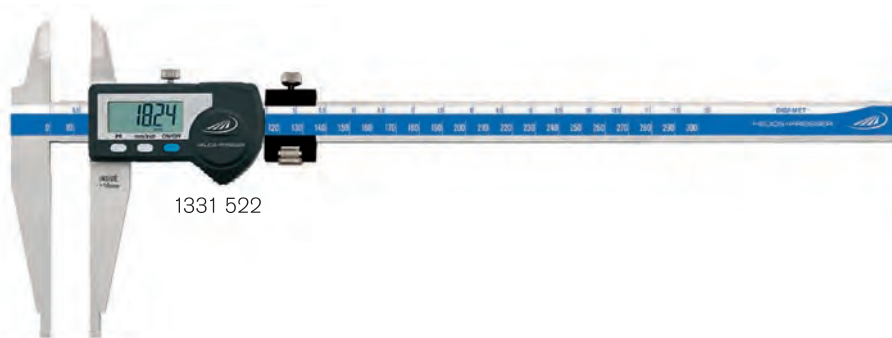

1331 522

### Model

- Stainless steel
- Inductive measuring system, resistant to damp and sweat
- Factory standard
- Knife points
- LCD display:
  - 10 mm with measuring range 300 mm;
  - 12.5 mm from measuring range 500 mm
- Locking screw

### Functions

- ON / OFF
- **Quick-Start**
- **Quick-Lock** (key lock)
- Set to zero at any point
- mm / inch switching
- PRESET-Function (setting a numerical value)
- Variable data output RS 232 + Digimatic + USB

### Delivery

- 300 mm Measuring range in plastic case
- From 500 mm measuring range in wooden case

☒	🇩🇪	Measuring range		Jaw length		Reading		Stepped jaws mm	Error limit mm	Order no.	List price EUR
		mm	inch	mm	inch	mm	inch				
<b>With knife points, without fine adjustment</b>											
▪		0 - 300	0 - 12	90	3.5	0.01	.0005	10	0.03	1330 522	449.00
▪		0 - 500	0 - 20	150	6.0	0.01	.0005	20	0.04	1330 528	685.00
▪		0 - 800	0 - 31	150	6.0	0.01	.0005	20	0.05	1330 532	1118.00
▪		0 - 1000	0 - 39	150	6.0	0.01	.0005	20	0.06	1330 534	1353.00
<b>With knife points, with fine adjustment</b>											
▪		0 - 300	0 - 12	90	3.5	0.01	.0005	10	0.03	1331 522	521.00
▪		0 - 500	0 - 20	150	6.0	0.01	.0005	20	0.04	1331 528	768.00
▪		0 - 800	0 - 31	150	6.0	0.01	.0005	20	0.05	1331 532	1183.00
▪		0 - 1000	0 - 39	150	6.0	0.01	.0005	20	0.06	1331 534	1360.00



1998720

1997501

1998501

### Accessories

- Data cable DATA VARIABLE to USB
- Data cable DATA VARIABLE to RS232
- Data cable DATA VARIABLE to Digimatic

### Order no.

- 1998 720
- 1997 501
- 1998 501

### List price EUR

- 82.00
- 57.00
- 73.00



# HELIOS · PREISSER

## 1340 / 1341 DIGI-MET® Workshop calipers IP65



1

### Model

- Stainless steel
- Inductive measuring system, protection class IP65
- Factory standard
- Knife points
- LCD display:
  - 10 mm with measuring range 300 mm;
  - 12.5 mm from measuring range 500 mm
- Locking screw

### Functions

- ON / OFF
- **Quick-Start**
- **Quick-Lock** (key lock)
- Set to zero at any point
- mm / inch switching
- PRESET-Function (setting a numerical value)
- Variable data output RS 232 + Digimatic + USB

### Delivery

- 300 mm Measuring range in plastic case
- From 500 mm measuring range in wooden case

✕	📏	Measuring range		Jaw length		Reading		Stepped jaws mm	Error limit mm	Order no.	List price EUR
		mm	inch	mm	inch	mm	inch				
<b>With knife points, without fine adjustment</b>											
▪		0 - 300	0 - 12	90	3.5	0.01	.0005	10	0.03	1340 522	486.00
▪		0 - 500	0 - 20	150	6.0	0.01	.0005	20	0.04	1340 528	927.00
▪		0 - 800	0 - 31	150	6.0	0.01	.0005	20	0.05	1340 532	1251.00
▪		0 - 1000	0 - 39	150	6.0	0.01	.0005	20	0.06	1340 534	1539.00
<b>With knife points, with fine adjustment</b>											
▪		0 - 300	0 - 12	90	3.5	0.01	.0005	10	0.03	1341 522	550.00
▪		0 - 500	0 - 20	150	6.0	0.01	.0005	20	0.04	1341 528	990.00
▪		0 - 800	0 - 31	150	6.0	0.01	.0005	20	0.05	1341 532	1313.00
▪		0 - 1000	0 - 39	150	6.0	0.01	.0005	20	0.06	1341 534	1601.00



### Accessories

- Data cable DATA VARIABLE to USB
- Data cable DATA VARIABLE to RS232
- Data cable DATA VARIABLE to digimatic

### Order no.

### List price EUR

1998720

1997501

1998501

1998 720

1997 501

1998 501

82.00

57.00

73.00



## 1334 / 1335 DIGI-MET® Workshop calipers



### Model

- Stainless steel
- Inductive measuring system, resistant to damp and sweat
- Factory standard
- LCD display:
  - 10 mm with measuring range 300 mm;
  - 12.5 mm from measuring range 500 mm
- Locking screw

### Functions

- ON / OFF
- **Quick-Start**
- **Quick-Lock** (key lock)
- Set to zero at any point
- mm / inch switching
- PRESET-Function (setting a numerical value)
- Variable data output RS 232 + Digimatic + USB

### Delivery

- 300 mm Measuring range in plastic case
- From 500 mm measuring range in wooden case

☒	☒	Measuring range		Jaw length		Reading		Stepped jaws mm	Error limit mm	Order no.	List price EUR
		mm	inch	mm	inch	mm	inch				
<b>Without fine adjustment</b>											
☒		0 - 300	0 - 12	90	3.5	0.01	.0005	10	0.03	1334 522	416.00
☒		0 - 500	0 - 20	150	6.0	0.01	.0005	20	0.04	1334 528	584.00
☒		0 - 800	0 - 31	150	6.0	0.01	.0005	20	0.05	1334 532	1020.00
☒		0 - 1000	0 - 39	150	6.0	0.01	.0005	20	0.06	1334 534	1208.00
<b>With fine adjustment</b>											
☒		0 - 300	0 - 12	90	3.5	0.01	.0005	10	0.03	1335 522	476.00
☒		0 - 500	0 - 20	150	6.0	0.01	.0005	20	0.04	1335 528	672.00
☒		0 - 800	0 - 31	150	6.0	0.01	.0005	20	0.05	1335 532	1097.00
☒		0 - 1000	0 - 39	150	6.0	0.01	.0005	20	0.06	1335 534	1260.00



### Accessories

- Data cable DATA VARIABLE to USB
- Data cable DATA VARIABLE to RS232
- Data cable DATA VARIABLE to Digimatic

### Order no.

### List price EUR

- 1998 720 82.00
- 1997 501 57.00
- 1998 501 73.00



# HELIOS · PREISSER

## 1342 / 1343 DIGI-MET® Workshop calipers IP65



1

### Model

- Stainless steel
- Inductive measuring system, protection class IP65
- Factory standard
- LCD display:
  - 10 mm with measuring range 300 mm;
  - 12.5 mm from measuring range 500 mm
- Locking screw

### Functions

- ON / OFF
- **Quick-Start**
- **Quick-Lock** (key lock)
- Set to zero at any point
- mm / inch switching
- PRESET-Function (setting a numerical value)
- Variable data output RS 232 + Digimatic + USB

### Delivery

- 300 mm Measuring range in plastic case
- From 500 mm measuring range in wooden case

Icon	Measuring range		Jaw length		Reading		Stepped jaws	Error limit	Order no.	List price
	mm	inch	mm	inch	mm	inch				
<b>Without fine adjustment</b>										
▪	0 - 300	0 - 12	90	3.5	0.01	.0005	10	0.03	1342 522	447.00
▪	0 - 500	0 - 20	150	6.0	0.01	.0005	20	0.04	1342 528	824.00
▪	0 - 800	0 - 31	150	6.0	0.01	.0005	20	0.05	1342 532	1141.00
▪	0 - 1000	0 - 39	150	6.0	0.01	.0005	20	0.06	1342 534	1419.00
<b>With fine adjustment</b>										
▪	0 - 300	0 - 12	90	3.5	0.01	.0005	10	0.03	1343 522	510.00
▪	0 - 500	0 - 20	150	6.0	0.01	.0005	20	0.04	1343 528	889.00
▪	0 - 800	0 - 31	150	6.0	0.01	.0005	20	0.05	1343 532	1204.00
▪	0 - 1000	0 - 39	150	6.0	0.01	.0005	20	0.06	1343 534	1481.00



### Accessories

	Order no.	List price
Data cable DATA VARIABLE to USB	1998 720	82.00
Data cable DATA VARIABLE to RS232	1997 501	57.00
Data cable DATA VARIABLE to digimatic	1998 501	73.00



## 0266 Caliper with gripper points

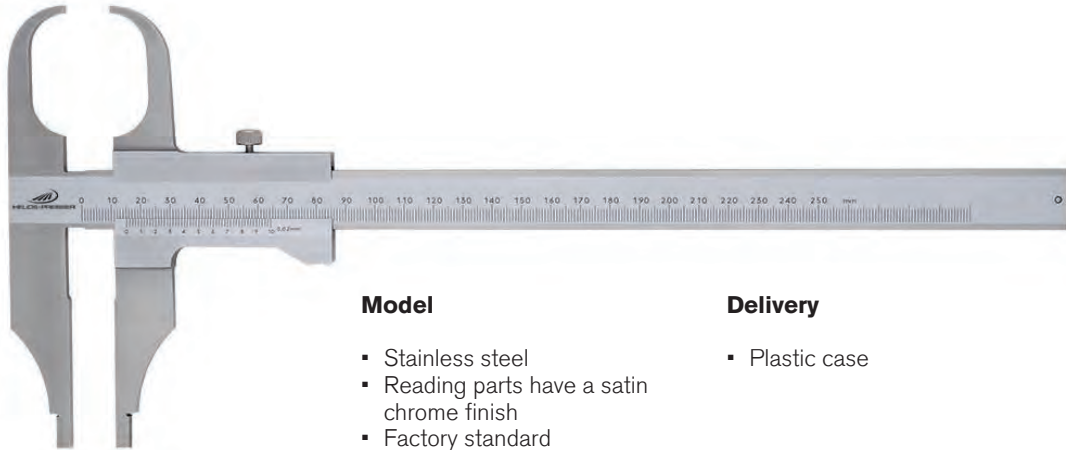

### Model

- Stainless steel
- Reading parts have a satin chrome finish
- Factory standard
- Locking screw
- Gripper points length 55 mm

### Delivery

- Plastic case

▶▶	▶▶	Measuring range		Jaw length		Reading	Error limit	Order no.	List price
		mm		mm	inch	mm	mm		EUR
		0 - 250		75	3.0	0.02	0.03	0266 52005	408.00



# HELIOS · PREISSER

## 1320 DIGI-MET® Pocket caliper with 40 mm inside cross points



1



### Model

- Inductive measuring system, resistant to damp and sweat
- Stainless steel
- LCD display 7.5 mm
- ISO 13385
- Locking screw
- Inside cross points
- Four way measurement

### Functions

- ON / OFF
- **Quick-Start**
- **Quick-Lock** (key lock)
- Set to zero at any point
- mm / inch switching
- Variable data output RS 232 + Digimatic + USB

### Delivery

- Plastic case

Icon	Measuring range		Jaw length		Reading		Error limit	Depth gauge	Order no.	List price
	mm	inch	mm	inch	mm	inch	mm	dia. mm		EUR
▪	0 - 150	0 - 6	40	1.6	0.01	.0005	0.03	round 1.5	1320 518	446.00

### Accessories



1998720



1998501



1997501

Data cable DATA VARIABLE to USB

Order no.

List price

EUR

1998 720

82.00

Data cable DATA VARIABLE to RS232

1997 501

57.00

Data cable DATA VARIABLE to digimatic

1998 501

73.00



## 1353 DIGI-MET® Caliper for external locking grooves

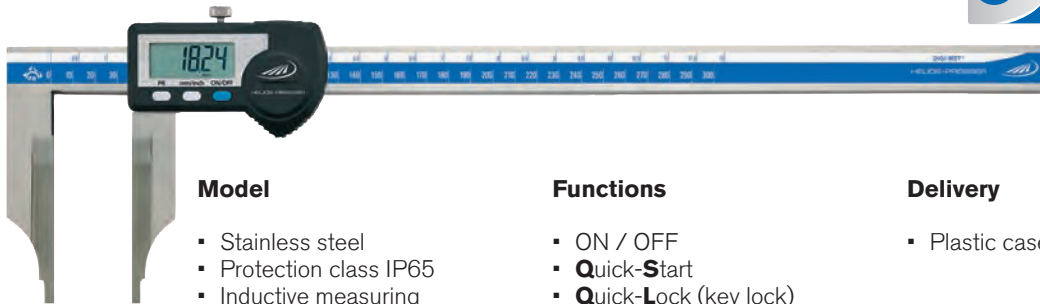

### Model

- Stainless steel
- Protection class IP65
- Inductive measuring system
- LCD display 10 mm
- Locking screw
- Factory standard

### Functions

- ON / OFF
- **Quick-Start**
- **Quick-Lock** (key lock)
- Set to zero at any point
- mm / inch switching
- PRESET-Function (setting a numerical value)
- Variable data output RS 232 + Digimatic + USB

### Delivery

- Plastic case

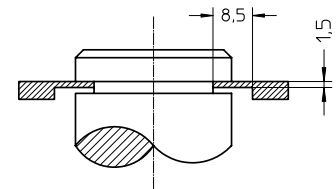

	Measuring range		Jaw length		Reading		Error limit	Order no.	List price
	mm	inch	mm	inch	mm	inch	mm		EUR
	0 - 300	0 - 12	90	3.5	0.01	.0005	0.03	1353 522	554.00

### Accessories

	Order no.	List price
		EUR
Data cable DATA VARIABLE to RS232	1997 501	57.00
Data cable DATA VARIABLE to digimatic	1998 501	73.00
Data cable DATA VARIABLE to USB	1998 720	82.00

## 0262 Caliper for external locking grooves

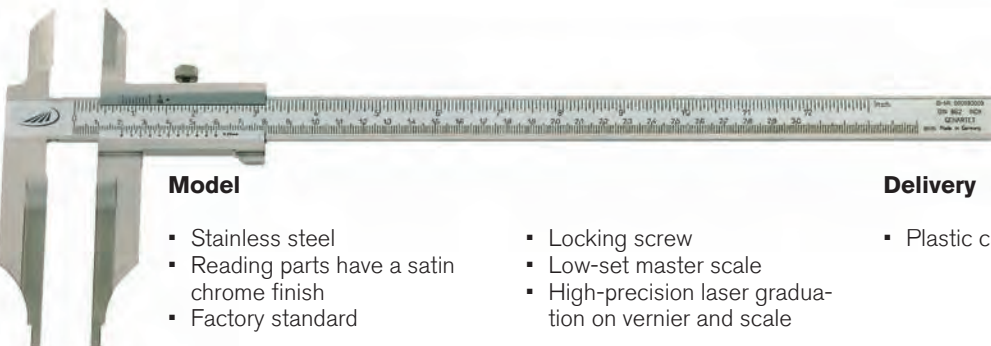

### Model

- Stainless steel
- Reading parts have a satin chrome finish
- Factory standard

- Locking screw
- Low-set master scale
- High-precision laser graduation on vernier and scale

### Delivery

- Plastic case

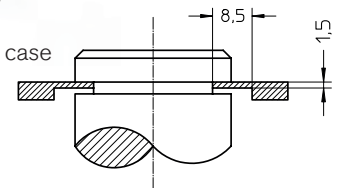

	Measuring range		Jaw length		Reading		Error limit	Order no.	List price
	mm	inch	mm	inch	mm	inch	mm		EUR
	0 - 300	0 - 12	90	3.5	0.05	1/128	0.03	0262 503	306.00





# HELIOS · PREISSER

## 1352 DIGI-MET® Calipers for internal grooves



1

### Model

- Stainless steel
- LCD display 7.5 mm
- Factory standard
- Locking screw
- IP67: up to 200 mm
- IP65: from 300 mm

### Functions

- ON / OFF
- **Quick-Start**
- **Quick-Lock** (key lock)
- Set to zero at any point
- mm / inch switching
- PRESET-Function (setting a numerical value)

### Delivery

- Variable data output RS 232 + Digimatic + USB
- Plastic case
- Setting ring sold separately

Measuring range	Jaw length		Reading		Error limit	Order no.	List price
	mm	mm	inch	mm			
10 - 160	25	1.0	0.01	0.06	1352 516	438.00	
20 - 160	40	1.5	0.01	0.06	1352 517	493.00	
26 - 200	60	2.3	0.01	0.06	1352 518	902.00	
35 - 300	100	3.9	0.01	0.06	1352 522	1059.00	

## 0258 Calipers for internal grooves

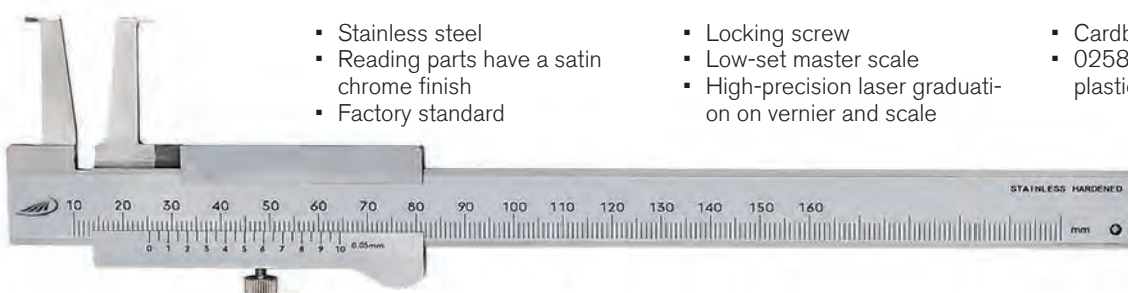

### Model

- Stainless steel
- Reading parts have a satin chrome finish
- Factory standard

### Delivery

- Locking screw
- Low-set master scale
- High-precision laser graduation on vernier and scale
- Cardboard box
- 0258503 in plastic case

Measuring range	Jaw length		Reading	Error limit	Order no.	List price
	mm	mm				
10 - 160	25	1.0	0.05	0.1	0258 501	163.00
20 - 160	40	1.5	0.05	0.1	0258 502	217.00
26 - 200	60	2.3	0.05	0.1	0258 503	333.00

Dimensions of 0258 and 1352

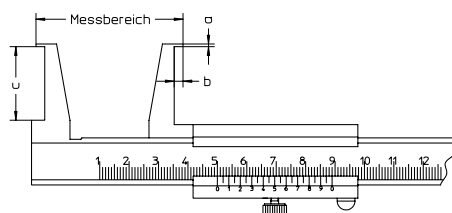

Measuring range mm	a	b	c
10 - 160	0.9	3.0	25
20 - 160	2.0	5.0	40
26 - 200	3.0	7.0	60
35 - 300	5.0	10.0	100



## 0260 Calipers for 3/5 point measurement

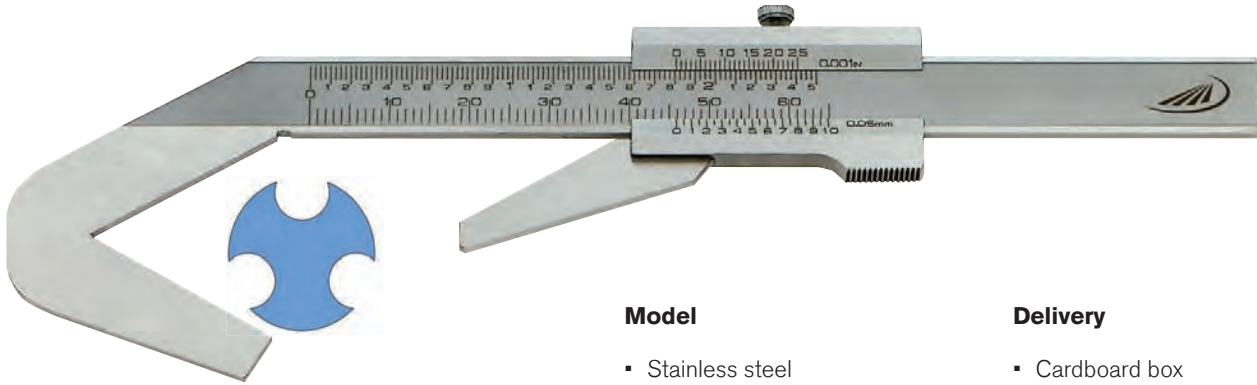

### Model

- Stainless steel
- Reading parts have a satin chrome finish
- Locking screw
- Factory standard

### Delivery

- Cardboard box

Measuring range	Reading		Error limit	Order no.	List price
	mm	mm    inch			
<b>3 point measurement</b>					
4 - 40	0.05	1/128	0.05	0260 501	84.00
<b>5 point measurement</b>					
2 - 40	0.05	1/128	0.05	0260 502	84.00



## 0597 Chamfer gauge

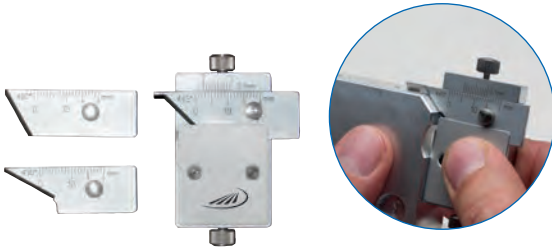

### Model

- Stainless steel
- Reading 0.1 mm
- Reading parts have a satin chrome finish
- For simultaneously testing of the chamfer angle and the dimensional accuracy
- Dimensions: 48 x 30 x 8.5 mm

### Delivery

- 3 interchangeable blades: 30°, 45°, 60°
- Plastic case

Icon	Measuring range	Reading	Order no.	List price
☒	mm	mm		EUR
	0 - 10	0.10	0597 301	198.00

1

## 0597 Radius gauge



### Model

- To determine radius size workpieces
- Stainless steel
- Reading parts are satin chrome finished

### Delivery

- Plastic case

Icon	Measuring range	Reading	Order no.	List price
☒	mm	mm		EUR
	0 - 10	0.10	0597 305	198.00



## 0268 Gear tooth calipers

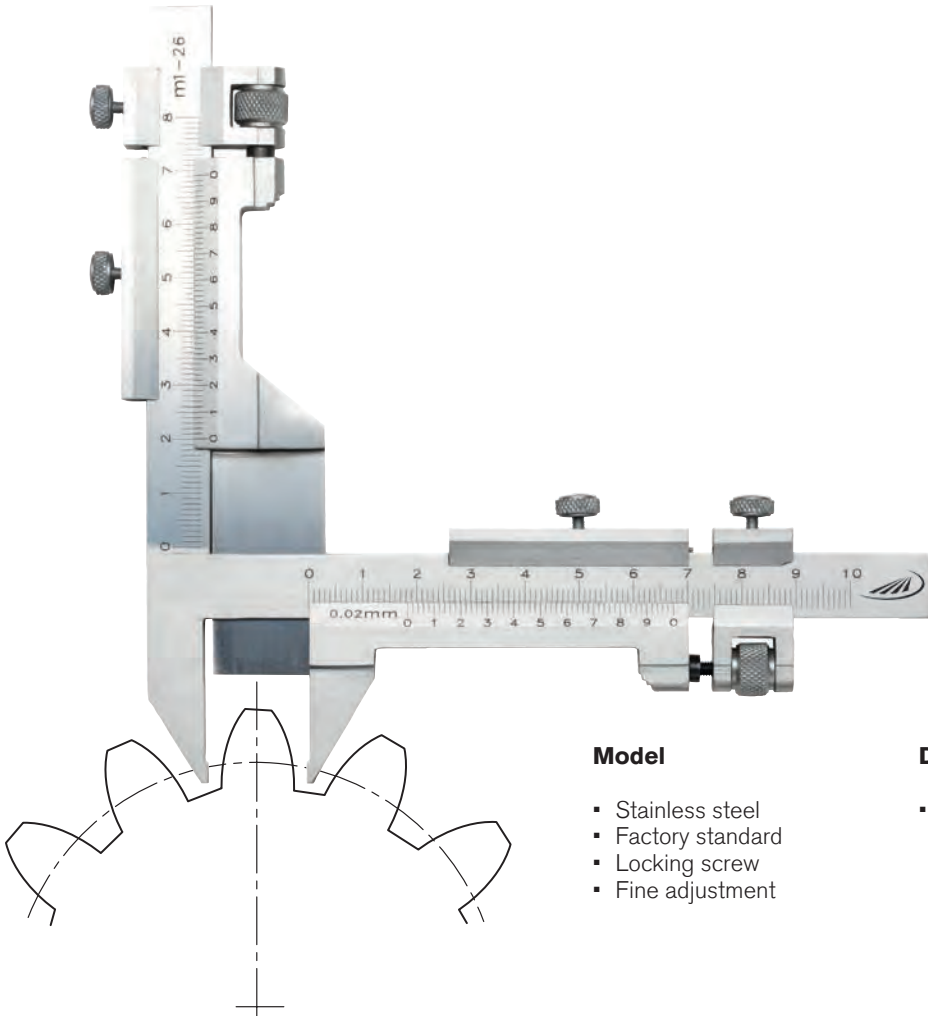

### Model

- Stainless steel
- Factory standard
- Locking screw
- Fine adjustment

### Delivery

- Wooden case

✂	🏠	Module	Reading mm	Error limit mm	Order no.	List price EUR
<b>Hardened jaw tips</b>						
		1 - 26	0.02	0.1	0268 201	348.00
<b>Carbide tipped jaw tips</b>						
		1 - 26	0.02	0.1	0268 211	424.00



## 0281 Vernier depth gauges



ISO  
13385

1

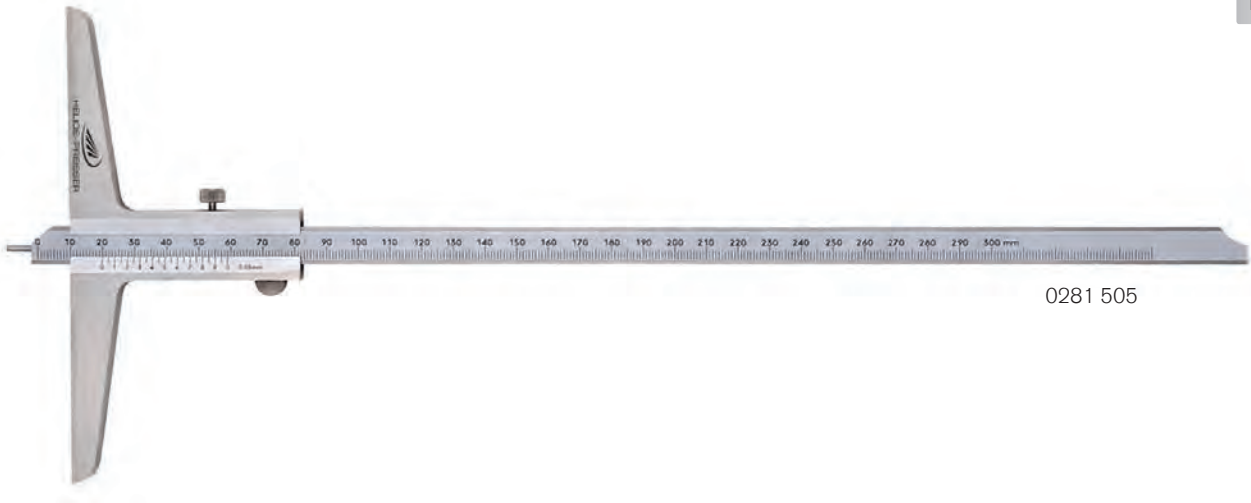

0281 505

### Model

- Stainless steel
- Reading parts have a satin chrome finish
- ISO 13385
- Low-set master scale
- Locking screw
- Measuring rod with interchangeable pin
- Double sided scale
- High-precision laser graduation on vernier and scale

### Delivery

- Plastic case

Icon	Measuring range mm	Length of beam mm	Reading mm	Error limit mm	Order no.	List price EUR
▪	0 - 150	100	0.05	0.05	0281 501	101.00
▪	0 - 200	100	0.05	0.05	0281 502	104.00
▪	0 - 300	150	0.05	0.05	0281 505	130.00

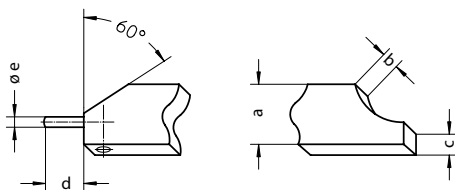

Measuring range mm	a	b	c	d	e
150 - 200	8.0	3.0	3.5	8.0	1.5
300	12.0	4.0	4.0	8.0	2.0



## 0282 Vernier depth gauges



ISO  
13385



### Model

- ISO 13385
- Locking screw
- Straight measuring rod
- Low-set master scale
- High-precision laser graduation on vernier and scale

### Delivery

- Plastic case

✕	Measuring range mm	Length of beam mm	Reading mm	Error limit mm	Order no.	List price EUR
<b>Stainless steel, vernier + scale satin chrome finished</b>						
▪	0 - 150	100	0.05	0.05	0282 501	88.00
▪	0 - 200	100	0.05	0.05	0282 502	93.00
▪	0 - 300	100	0.05	0.05	0282 503	105.00
▪	0 - 300	150	0.05	0.05	0282 505	112.00
▪	0 - 500	150	0.05	0.07	0282 507	172.00
▪	0 - 500	250	0.05	0.07	0282 508	262.00
▪	0 - 800	250	0.05	0.10	0282 509	437.00
▪	0 - 1000	250	0.05	0.12	0282 510	618.00

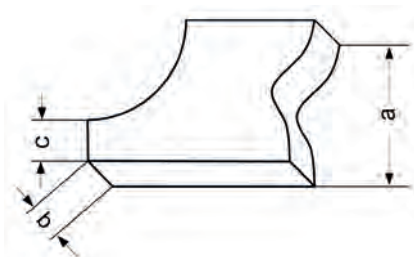

Measuring range mm	a	b	c
150 - 200	8.0	3.0	3.5
250 - 500	12.0	4.0	4.0
500 - 1000	20.0	5.0	10.0



## 0286 Vernier depth gauges



ISO  
13385

1

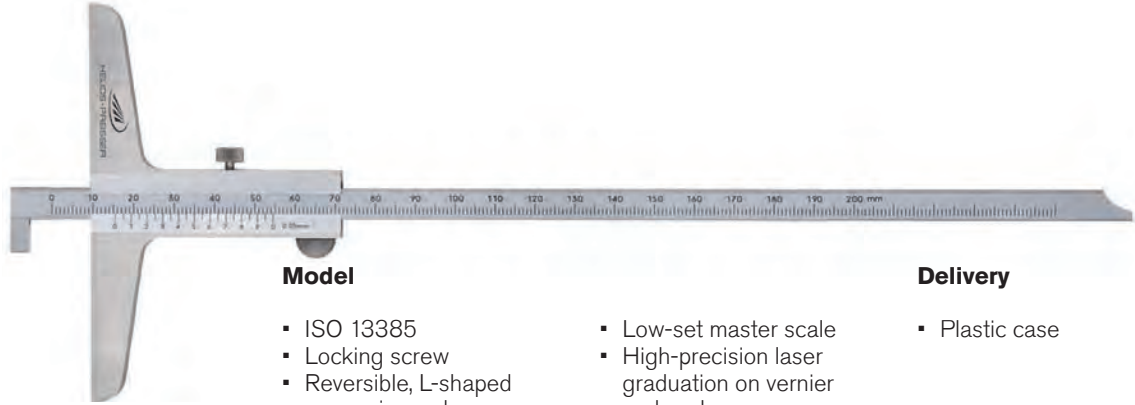

### Model

- ISO 13385
- Locking screw
- Reversible, L-shaped measuring rod
- Scales on both sides

### Delivery

- Plastic case

Measuring range mm	Length of beam mm	Reading mm	Error limit mm	Order no.	List price EUR
<b>Stainless steel, vernier + scale satin chrome finished</b>					
0 - 150	100	0.05	0.05	0286 501	105.00
0 - 200	100	0.05	0.05	0286 502	106.00
0 - 300	150	0.05	0.05	0286 505	130.00
0 - 500	150	0.05	0.07	0286 507	208.00

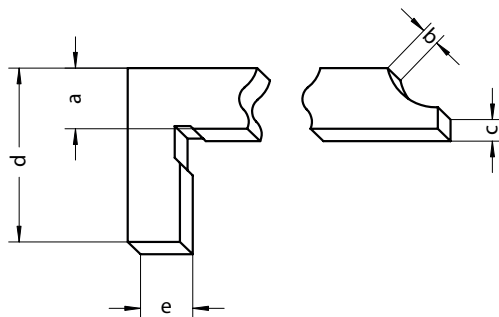

Measuring range mm	a	b	c	d	e
150 - 200	8,0	3,0	3,5	20,0	5,0
250 - 500	12,0	4,0	4,0	28,0	10,0

## 0292 Offset vernier depth gauges



### Model

- Stainless steel
- Reading parts have a satin chrome finish
- Factory standard
- Locking screw
- Reversible, offset meas. rod

### Delivery

- Plastic case

Measuring range mm	Length of beam mm	Reading mm	Error limit mm	Order no.	List price EUR
0 - 200	100	0.05	0.05	0292 501	100.00
0 - 300	100	0.05	0.05	0292 502	113.00

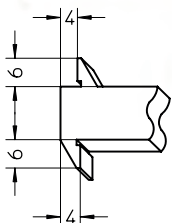



## 1361 DIGI-MET® Depth gauges

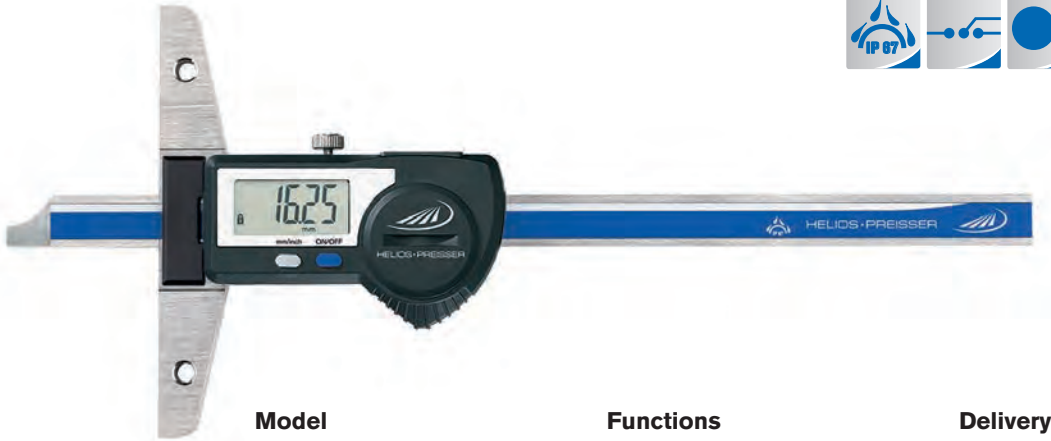

### Model

- Stainless steel
- Protection class IP67
- LCD display 7,5 mm
- ISO 13385
- Locking screw
- Straight measuring rod

### Functions

- ON / OFF
- **Quick-Start**
- **Quick-Lock** (key lock)
- Set to zero at any point
- mm / inch switchin
- Variable data output RS 232 + Digimatic + USB

### Delivery

- Plastic case
- From 500 mm measuring range in wooden case
- Screw-on extended measuring bridges must be ordered separately (page 53)

Marked	Measuring range	Length of beam		Reading		Error limit	Order no.	List price
		mm	inch	mm	inch			
▪	0 - 150	0 - 6	100	0.01	.0005	0.03	1361 716	371.00
▪	0 - 200	0 - 8	100	0.01	.0005	0.03	1361 718	421.00
▪	0 - 300	0 - 12	150	0.01	.0005	0.04	1361 722	473.00
▪	0 - 500	0 - 20	150	0.01	.0005	0.05	1361 728	543.00



1998720

1997501

1998501

### Accessories

- Data cable DATA VARIABLE to RS232
- Data cable DATA VARIABLE to digimatic
- Data cable DATA VARIABLE to USB

### Order no.

- 1997 501
- 1998 501
- 1998 720

### List price

- EUR 57.00
- EUR 73.00
- EUR 82.00





## 1363 DIGI-MET® Depth gauges



1



### Model

- Stainless steel
- Protection class IP67
- LCD display 7.5 mm
- ISO 13385
- Locking screw
- L-shaped measuring rod

### Functions

- ON / OFF
- Set to zero at any point
- mm / inch switching
- **Quick-Start**
- **Quick-Lock** (key lock)
- PRESET-Function (setting a numerical value)
- Variable data output RS 232 + Digimatic + USB

### Delivery

- 300 mm measuring range in plastic case
- 500 mm measuring range in wooden case
- Screw-on extended measuring bridges must be ordered separately (page 53)

Icon	Measuring range		Length of beam mm	Reading		Error limit mm	Order no.	List price EUR
	mm	inch		mm	inch			
▪	0 - 300	0 - 12	150	0.01	.0005	0.03	1363 722	484.00
▪	0 - 500	0 - 20	150	0.01	.0005	0.04	1363 728	563.00



1998720      1997501      1998501

### Accessories

	Order no.	List price EUR
Data cable DATA VARIABLE to RS232	1997 501	57.00
Data cable DATA VARIABLE to digimatic	1998 501	73.00
Data cable DATA VARIABLE to USB	1998 720	82.00

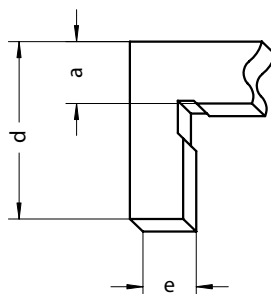

Measuring range mm	a	e	d
300	11.6	10	28
500	11.6	10	28



## 1365 DIGI-MET® Depth gauges



### Model

- Stainless steel
- Protection class IP67
- LCD display 7.5 mm
- ISO 13385
- Locking screw
- Replaceable pin

### Functions

- ON / OFF
- **Quick-Start**
- **Quick-Lock** (key lock)
- Set to zero at any point
- mm / inch switching
- Variable data output RS 232 + Digimatic + USB

### Delivery

- Plastic case
- Screw-on extended measuring bridges must be ordered separately (page 53)

Marked	Marked	Measuring range		Length of beam mm	Reading		Error limit mm	Order no.	List price EUR
		mm	inch		mm	inch			
▪		0 - 200	0 - 8	100	0.01	.0005	0.03	1365 722	458.00
▪		0 - 300	0 - 12	150	0.01	.0005	0.04	1365 728	510.00

### Accessories



1998720

1997501

1998501

Data cable DATA VARIABLE to RS232

Order no.

List price

EUR

Data cable DATA VARIABLE to digimatic

1997 501

57.00

Data cable DATA VARIABLE to USB

1998 501

73.00

1998 720

82.00



## 1367 DIGI-MET® Offset depth gauges



1

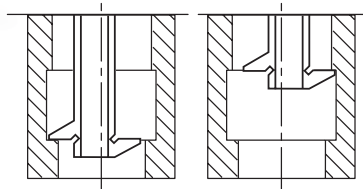

### Model

- Stainless steel
- Inductive measuring system, protection class IP67
- LCD display 7.5 mm
- Factory standard
- Housing and operating keys have an excellent chemical resistance
- Locking screw

### Functions

- ON / OFF
- **Quick-Start**
- **Quick-Lock** (key lock)
- Set to zero at any point
- mm / inch switching
- Variable data output RS 232 + Digimatic + USB

### Delivery

- Up to 300 mm measuring range in plastic case
- From 500 mm measuring range in wooden case
- Screw-on extended measuring bridges must be ordered separately (page 53)

Icon	Measuring range		Length of beam	Reading		Error limit	Order no.	List price
	mm	inch		mm	inch			
▪	0 - 200	0 - 8	100	0.01	.0005	0.03	1367 718	476.00
▪	0 - 300	0 - 12	150	0.01	.0005	0.03	1367 722	575.00
▪	0 - 500	0 - 20	150	0.01	.0005	0.03	1367 728	724.00



### Accessories

	Order no.	List price
		EUR
Data cable DATA VARIABLE to RS232	1997 501	57.00
Data cable DATA VARIABLE to digimatic	1998 501	73.00
Data cable DATA VARIABLE to USB	1998 720	82.00

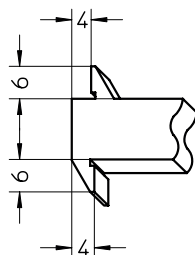



## 1372i DIGI-MET® Depth gauges IP67 with integrated wireless



1372 41660

## integrated IW wireless

Wireless Data Transmission

### Model

- Stainless steel
- Inductive measuring system, protection class IP67
- ISO 13385
- Locking screw
- LCD display 11 mm
- Measuring pin dia. 1.5 mm

### Functions

- ON / OFF
- **Quick-Start**
- **Quick-Lock** (key lock)
- **PRESET-Function** (setting a numerical value)
- Set to zero at any point
- mm / inch switching
- Integrated Wireless

### Delivery

- Plastic case
- Screw-on extended measuring bridges must be ordered separately (page 53)



More information on our i-series and Integrated Wireless on page 224

Marked *	Measuring range		Length of beam mm	Reading		Error limit mm	Order no.	List price EUR
	mm	inch		mm	inch			
▪	0 - 150	0 - 6	100	0.01	.0005	0.03	1372 41660	487.00
▪	0 - 200	0 - 8	100	0.01	.0005	0.03	1372 41860	518.00
▪	0 - 300	0 - 12	150	0.01	.0005	0.04	1372 42260	582.00
▪	0 - 500	0 - 20	150	0.01	.0005	0.05	1372 42860	660.00



1998780

### Accessories

	Order no.	List price EUR
i-Stick USB-receiver for Integrated Wireless	1998 780	108.00

Integrated Wireless is intended to be sold within the European Economic Area only



## 1372 DIGI-MET® Depth gauges IP67



1372 416

### Model

- Stainless steel
- Inductive measuring system, protection class IP67
- ISO 13385
- Locking screw
- LCD display 11 mm
- Measuring pin dia. 1.5 mm

### Functions

- ON / OFF
- **Quick-Start**
- **Quick-Lock** (key lock)
- PRESET-Function (setting a numerical value)
- Set to zero at any point
- mm / inch switching

### Delivery

- Plastic case
- Screw-on extended measuring bridges must be ordered separately (page 53)

⌘	Measuring range		Length of beam mm	Reading		Error limit mm	Order no.	List price EUR
	mm	inch		mm	inch			
▪	0 - 150	0 - 6	100	0.01	.0005	0.03	1372 416	438.00
▪	0 - 200	0 - 8	100	0.01	.0005	0.03	1372 418	481.00
▪	0 - 300	0 - 12	150	0.01	.0005	0.04	1372 422	536.00
▪	0 - 500	0 - 20	150	0.01	.0005	0.05	1372 428	617.00

## 1271 Extension depth attachment base



1271 451

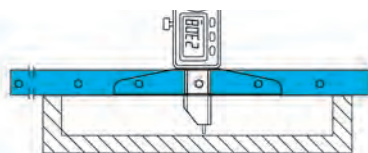

⌘	Measuring bridge length mm	Order no.	List price EUR
	200	1271 451	101.00
	300	1271 452	117.00

## 1271 Measuring insert for distance measurements



### Model

- To be attached to the measuring pin
- Ball dia. 4 mm

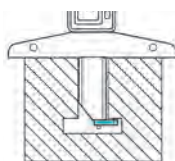

⌘	Order no.	List price EUR
	1271 455	67.00



## 1376 DIGI-MET® Depth gauge



### Example of use

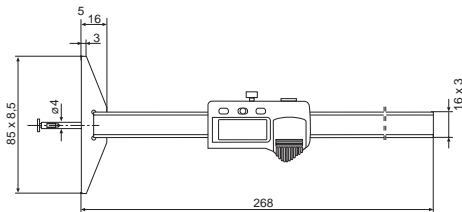
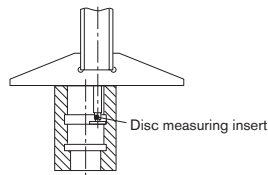
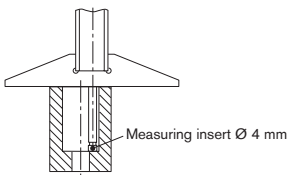

### Model

- Stainless steel
- Protection class IP67
- LCD display 7.5 mm
- Locking screw
- ISO 13385

### Functions

- ON / OFF
- **Quick-Start**
- **Quick-Lock** (key lock)
- Set to zero at any point
- mm / inch switching
- Reversal of counting direction

- PRESET-Function (setting a numerical value)
- Variable data output RS 232 + Digimatic + USB

### Delivery

- Plastic case
- Disc type insert Ø 7.5 x 1 mm
- Inserts Ø 4 mm, flat and spherical

Measuring range	Length of beam		Reading		Error limit	Order no.	List price
	mm	inch	mm	inch			
0 - 100	0 - 4	85	0.01	.0005	0.02	1376 514	583.00



### Accessories

	Order no.	List price
Disc type measuring insert Ø 7.5 x 1 mm	1276 591	21.20
Flat measuring insert Ø 4 mm	1276 592	20.30
Spherical measuring insert Ø 4 mm	1276 593	28.20
Data cable DATA VARIABLE to RS232	1997 501	57.00
Data cable DATA VARIABLE to digimatic	1998 501	73.00
Data cable DATA VARIABLE to USB	1998 720	82.00



# HELIOS · PREISSER

## 1375 DIGI-MET® Small depth gauge



1

### Model

- Beam made from stainless steel
- Aluminium body black anodized
- Protection class IP67
- LCD display 7.5 mm
- Factory standard
- Measuring pin Ø 2 mm

### Functions

- ON / OFF
- **Quick-Start**
- **Quick-Lock** (key lock)
- Set to zero at any point
- PRESET-Function (setting a numerical value)
- mm / inch switching
- Variable data output RS 232 + Digimatic + USB

### Delivery

- Case

Icon	Measuring range		Length of beam	Reading		Error limit	Order no.	List price
	mm	inch	mm	mm	inch	mm		EUR
	0 - 25	0 - 1	48	0.01	.0005	0.01	1375 502	281.00



### Accessories

	Order no.	List price
		EUR
Data cable DATA VARIABLE to RS232	1997 501	57.00
Data cable DATA VARIABLE to digimatic	1998 501	73.00
Data cable DATA VARIABLE to USB	1998 720	82.00



## 0633 Steel gauge block inspection set for calipers

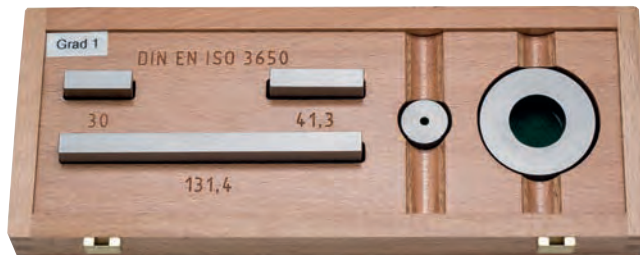

### Model

- EN ISO 3650
- Special steel, hardened
- Tolerance class 1
- Supplied with: setting rings 4 mm and 25 mm

### Delivery

- Wooden box

	For measuring range mm	Max. nominal size mm	Order no.	List price EUR
<b>3 pieces</b>	200	30.0 / 41.3 / 131.4	0633 833	635.00
<b>4 pieces</b>	300	30.0 / 41.3 / 131.4 / 243.5	0633 834	847.00
<b>6 pieces</b>	500	30.0 / 41.3 / 131.4 / 243.5 / 281.2 / 481.1	0633 836	1512.00
<b>5 pieces</b>	1000	131.4 / 243.5 / 281.2 / 481.1 / 900	0633 838	2673.00





## 0003 Wooden cases for calipers



0003 219



0003 231



0003 247

1

	Internal dimensions L x W x H mm	Order no.	List price EUR
<b>With flat foam inlay</b>			
	250 x 90 x 20	0003 219	8.70
	315 x 145 x 20	0003 220	10.40
	370 x 145 x 20	0003 221	13.10
	435 x 175 x 20	0003 222	18.10
	435 x 205 x 20	0003 223	20.20
	610 x 180 x 20	0003 224	30.50
	590 x 220 x 20	0003 225	39.60
	690 x 200 x 20	0003 228	53.00
	690 x 250 x 25	0003 229	54.00
	700 x 315 x 25	0003 230	56.00
	700 x 350 x 21	0003 231	57.00
	1000 x 270 x 25	0003 237	75.00
	1100 x 480 x 25	0003 241	97.00
	1200 x 220 x 25	0003 242	93.00
	1300 x 600 x 25	0003 247	153.00
▪	1800 x 310 x 25	0003 251	172.00
▪	1800 x 380 x 25	0003 252	186.00

Matching wooden boxes on request!



# SAMPLES MICROMETERS

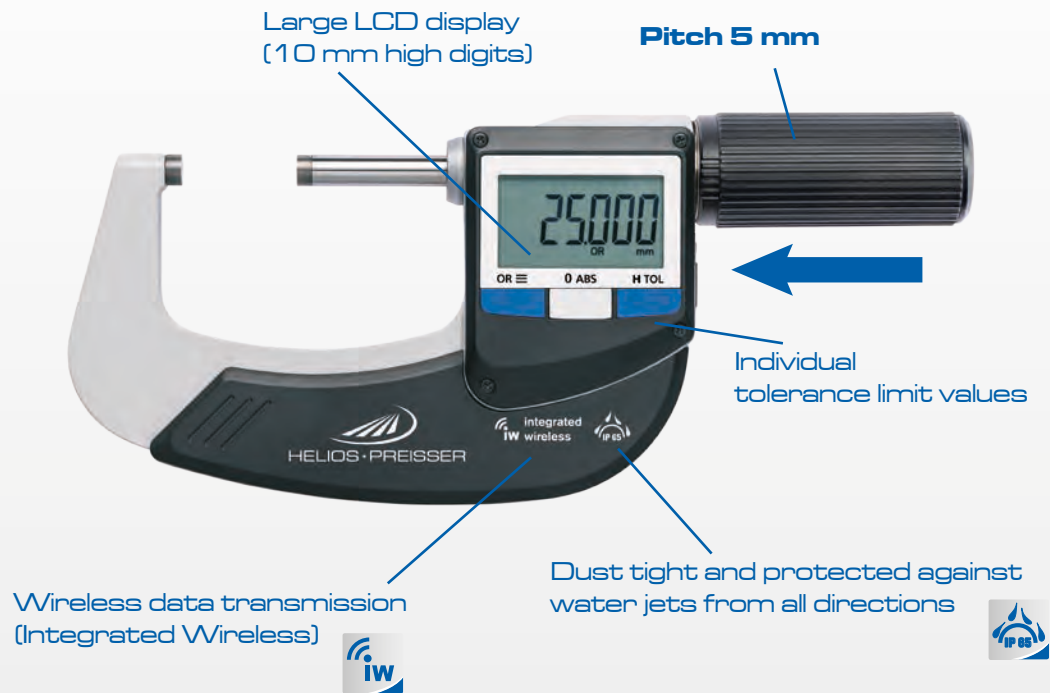
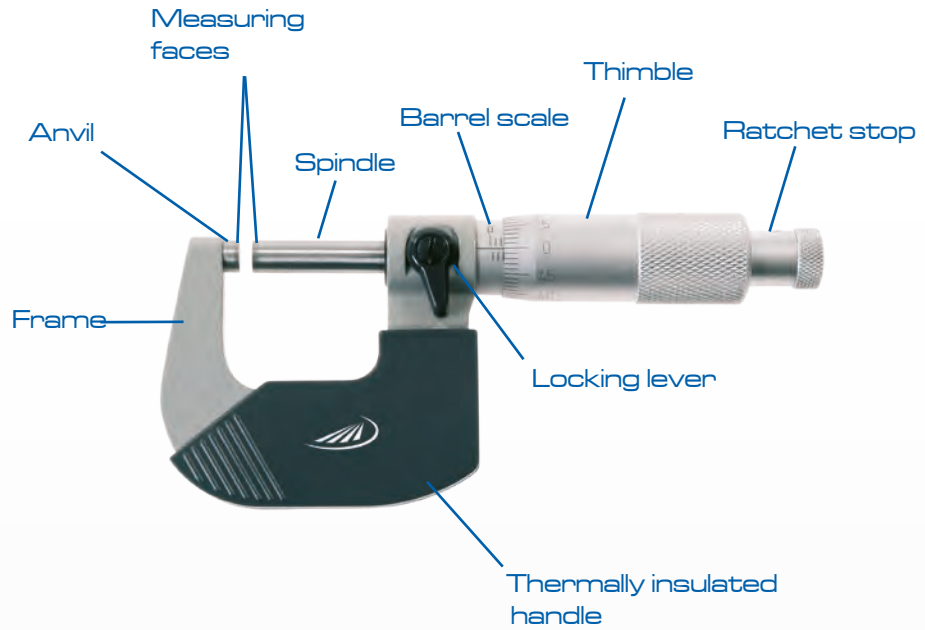

## Micrometer highlights from our assortment



INTERNAL MICROMETERS



SPECIAL MICROMETERS



HOLDER & SETTING STANDARDS

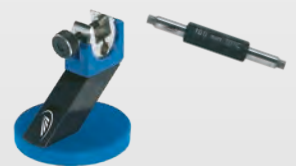

## 2. CHAPTER MICROMETERS

60	External micrometers
67	Digital external micrometers
72	Precision dial micrometers
74	External micrometers with special measuring faces
75	Setting standards for micrometers
76	External micrometers for thread flank measurement
79	External micrometers for gear tooth measurements
79	Wire micrometer
84	Internal micrometers
86	Digital 3 point internal micrometers
88	Digital internal micrometers / with measuring pistol
90	Measuring heads and extensions
91	Depth micrometers



## 0800 External micrometers



0800 501

**DIN  
863-1**

### Model

- DIN 863-1
- Reading: 0.01 mm
- Reading parts are satin chrome finished
- Locking lever
- Ratchet stop
- Carbide measuring faces
- Thermally insulated

### Delivery

- Plastic case
- From measuring range 25 - 50 mm upwards includes a setting standard

✕	⚙	Measuring range mm	Pitch mm	Spindle dia. mm	Thimble dia. mm	Error limit mm	Order no.	List price EUR
		0 - 25	0.5	6.5	17	0.004	0800 501	21.40
		25 - 50	0.5	6.5	17	0.004	0800 502	25.90
		50 - 75	0.5	6.5	17	0.005	0800 503	29.70
		75 - 100	0.5	6.5	17	0.005	0800 504	35.10

## 0800 Set of external micrometers



### Delivery

- Includes 4 external micrometers
- Incl. setting gauges 25/50/75 mm
- Wooden case

**DIN  
863-1**

✕	⚙	Measuring range mm	Pitch mm	Spindle dia. mm	Thimble dia. mm	Order no.	List price EUR
		0 - 100	0.5	6.5	17	0800 513	124.00

## 0807 Holder for external micrometers



### Model

- With heavy cast iron base
- Vertically rotating and lockable

### Delivery

- Cardboard box

✕	⚙	Measuring range mm	Order no.	List price EUR
		0 - 300	0807 101	64.00



## 0806 External micrometers with friction clutch



**DIN**  
**863-1**



0806 501

### Model

- DIN 863-1
- Reading: 0.01 mm
- Reading parts are satin chrome finished
- Locking lever
- With friction clutch (ratchet)
- Fixed quick drive
- Carbide measuring faces
- Thermally insulated

### Delivery

- Plastic case
- From measuring range 25 - 50 mm upwards includes a setting gauge

⌘	⌘	Measuring range mm	Pitch mm	Spindle dia. mm	Thimble dia. mm	Error limit mm	Order no.	List price EUR
		0 - 25	0.5	6.5	18	0.004	0806 501	38.50
		25 - 50	0.5	6.5	18	0.004	0806 502	42.10
		50 - 75	0.5	6.5	18	0.005	0806 503	45.80
		75 - 100	0.5	6.5	18	0.005	0806 504	49.50

2

## 0806 Set of external micrometers with friction clutch



**DIN**  
**863-1**



0806 513

### Delivery

- Includes 4 external micrometers
- Incl. setting gauges 25/50/75 mm
- Wooden case

⌘	⌘	Measuring range mm	Pitch mm	Spindle dia. mm	Thimble dia. mm	Error limit mm	Order no.	List price EUR
		0 - 100	0.5	6.5	18	0.005	0806 513	181.00



## 0806 External micrometers



**DIN  
863-1**



### Model

- DIN 863-1
- Reading 0.01 mm
- Reading parts are satin chrome finished
- Locking lever
- Ratchet stop
- Carbide measuring faces
- Thermally insulated
- Coated steel frame

### Delivery

- Plastic case
- From measuring range 25 - 50 mm upwards includes a setting standard

✕	¼	Measuring range mm	Pitch mm	Spindle dia. mm	Thimble dia. mm	Error limit mm	Order no.	List price EUR
		0 - 25	0.5	6.5	17.5	0.004	0806 521	52.00
		25 - 50	0.5	6.5	17.5	0.004	0806 522	84.00
		50 - 75	0.5	6.5	17.5	0.005	0806 523	103.00
		75 - 100	0.5	6.5	17.5	0.005	0806 524	119.00
		100 - 125	0.5	6.5	17.5	0.006	0806 525	162.00
		125 - 150	0.5	6.5	17.5	0.006	0806 526	181.00
		150 - 175	0.5	6.5	17.5	0.007	0806 527	201.00
		175 - 200	0.5	6.5	17.5	0.007	0806 528	221.00

## 0806 Set of external micrometers



**DIN  
863-1**



### Delivery

- Includes 4 external micrometers
- Incl. setting gauges 25 + 75 mm or 125 + 175 mm
- Wooden case

✕	¼	Measuring range mm	Pitch mm	Spindle dia. mm	Thimble dia. mm	Order no.	List price EUR
		0 - 100	0.5	6.5	17.5	0806 540	310.00
		100 - 200	0.5	6.5	17.5	0806 542	682.00



## 0810 External micrometers



**DIN**  
**863-1**

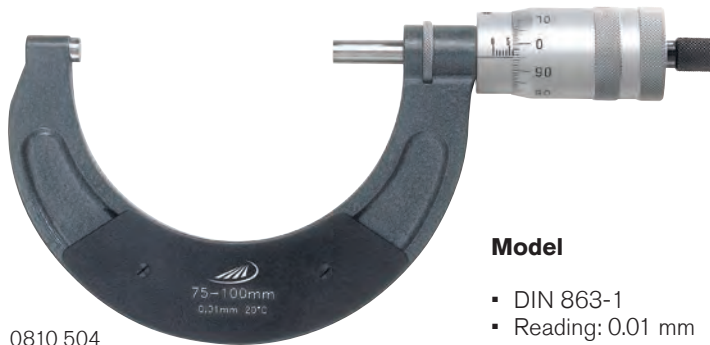

0810 504

### Model

- DIN 863-1
- Reading: 0.01 mm
- Reading parts are satin chrome finished
- Locking ring
- Spheroid ductile iron frame, lacquered
- Ratchet stop
- Carbide measuring faces
- Thermally insulated

### Delivery

- Wooden case

2

⌘	⊘	Measuring range mm	Pitch mm	Spindle dia. mm	Thimble dia. mm	Error limit mm	Order no.	List price EUR
		0 - 25	1	8	30	0.004	0810 501	312.00
		25 - 50	1	8	30	0.004	0810 502	330.00
		50 - 75	1	8	30	0.005	0810 503	346.00
		75 - 100	1	8	30	0.005	0810 504	367.00

## 0815 External micrometers with deep frame



**DIN**  
**863-1**



0815 530

### Model

- DIN 863-1
- Reading: 0.01 mm
- Reading parts are satin chrome finished
- Steel bracket lacquered
- Ratchet stop
- Carbide measuring faces

### Delivery

- Wooden case

⌘	⊘	Measuring range mm	Frame depth mm	Pitch mm	Spindle dia. mm	Thimble dia. mm	Error limit mm	Order no.	List price EUR
		0 - 25	100	1	8	24	0.004	0815 510	328.00
		0 - 25	150	1	6.5	24	0.004	0815 514	346.00
		0 - 25	250	1	6.5	24	0.004	0815 518	432.00
		0 - 50	50	1	8	24	0.004	0815 530	372.00
		0 - 50	100	1	8	24	0.004	0815 534	549.00
		50 - 100	100	1	8	24	0.005	0815 540	607.00



## 0816 External micrometers large spindle distance 50 mm



**DIN  
863-1**



### Model

- DIN 863-1
- Direct reading 0.01 mm, without addition because of thread pitch 1 mm
- Reading parts are satin chrome finished
- Locking ring
- Ratchet stop
- Carbide measuring faces
- Thermally insulated
- With 50 mm spindle movement and a wide measuring range
- Spheroid ductile iron frame, lacquered or coated light alloy frame

### Delivery

- Wooden case

✕	⊘	Measuring range mm	Pitch mm	Spindle dia. mm	Thimble dia. mm	Error limit mm	Order no.	List price EUR
		0 - 50	1	8	24	0.004	0816 501	393.00
		50 - 100	1	8	24	0.005	0816 502	443.00
		100 - 150	1	8	24	0.006	0816 503	511.00
		150 - 200	1	8	24	0.007	0816 504	583.00
		200 - 250	1	8	24	0.008	0816 505	664.00
		250 - 300	1	8	24	0.009	0816 506	749.00
		300 - 350	1	10	24	0.01	0816 507	1058.00
		350 - 400	1	10	24	0.011	0816 508	1117.00
		400 - 450	1	10	24	0.012	0816 509	1187.00
		450 - 500	1	10	24	0.013	0816 510	1274.00
		500 - 550	1	10	24	0.015	0816 511	1374.00
		550 - 600	1	10	24	0.017	0816 512	1470.00





## 0817 External micrometers with wide range of applications 100 mm



DIN  
863-3



2

### Model

- DIN 863-3
- Direct reading 0.01 mm, without addition because of thread pitch 1 mm
- Reading parts are satin chrome finished
- Spindle adjustment 50 mm
- Reversible anvil (screwed) for measuring range extension
- Locking ring
- Ratchet stop
- Carbide measuring faces
- Thermally insulated
- Robust coated light alloy frame

### Delivery

- Wooden case

⏏	⚙	Measuring range mm	Pitch mm	Spindle dia. mm	Thimble dia. mm	Error limit mm	Order no.	List price EUR
		200 - 300	1	10	24	0.006	0817 512	1263.00
		300 - 400	1	10	24	0.007	0817 514	1313.00
		400 - 500	1	10	24	0.008	0817 516	1470.00
		500 - 600	1	10	24	0.009	0817 518	1668.00
		600 - 700	1	10	24	0.009	0817 520	1866.00
	▪	700 - 800	1	10	24	0.009	0817 522	2070.00
	▪	800 - 900	1	10	24	0.01	0817 524	2278.00
	▪	900 - 1000	1	10	24	0.01	0817 526	2520.00



## 0819 External micrometers with interchangeable inserts

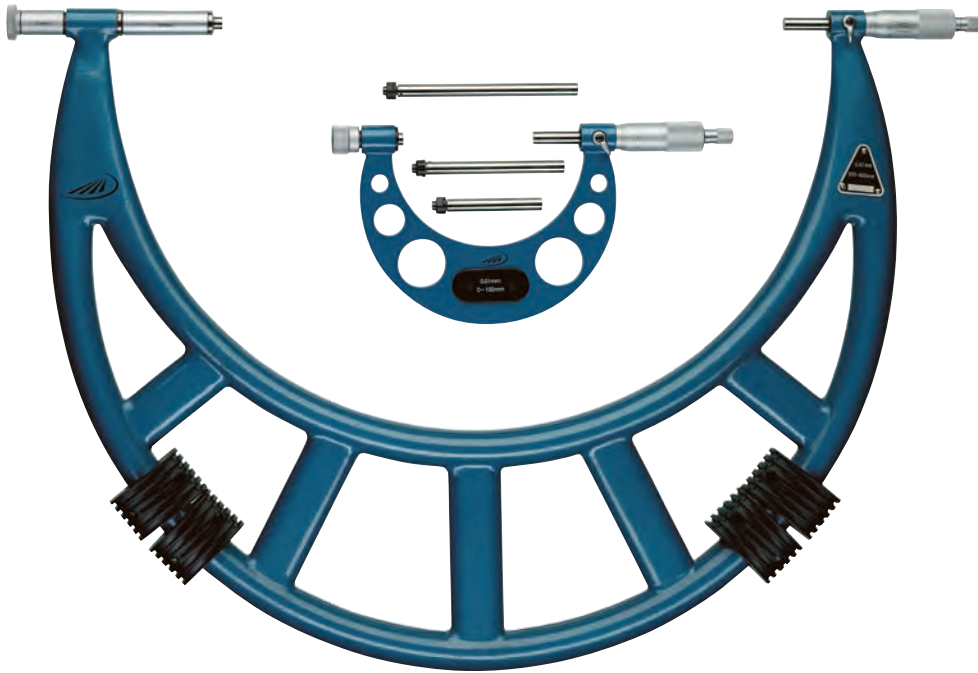

### Model

- Reading: 0.01 mm
- Reading parts are satin chrome finished
- Locking lever
- Ratchet stop
- Carbide measuring faces
- Thermally insulated
- Coated malleable cast iron frame\* or coated light alloy frame with interchangeable anvil

### Delivery

- Wooden case
- Includes setting standards

✕	¼	Measuring range mm	Pitch mm	Spindle dia. mm	Thimble dia. mm	Order no.	List price EUR
		0 - 100	0.5	8	20	0819 501	208.00
		0 - 150	0.5	8	20	0819 502	232.00
		100 - 200	0.5	8	20	0819 503	256.00
		150 - 300	0.5	8	20	0819 505	292.00
		200 - 300	0.5	8	20	0819 510	281.00
		300 - 400	0.5	8	24	0819 511	354.00
		400 - 500	0.5	8	24	0819 512	403.00
		500 - 600	0.5	8	24	0819 513	465.00
		600 - 700	0.5	8	24	0819 514	573.00
	▪	700 - 800	0.5	8	24	0819 515	660.00
	▪	800 - 900	0.5	8	24	0819 516	757.00
	▪	900 - 1000	0.5	8	24	0819 517	855.00
	▪	1000 - 1200	1	8	30	0819 519	1587.00
	▪	1200 - 1400	1	8	30	0819 521	1709.00
	▪	1400 - 1600	1	8	30	0819 523	2013.00
	▪	1600 - 1800	1	8	30	0819 525	2313.00
	▪	1800 - 2000	1	8	30	0819 527	2660.00



HELIOS · PREISSER

## 0912 Digital micrometers IP54



### Model

- Protection class IP54
- Reading: 0.001 mm / .00005 inch
- Locking lever
- Ratchet stop
- Carbide measuring faces
- Thermally insulated
- Factory standard

### Functions

- ON / OFF
- mm / inch switching
- Set to zero at any point

### Delivery

- Plastic case
- From measuring range 25 mm upwards includes a setting standard

Icon	Measuring range		Pitch	Spindle dia.	Error limit	Order no.	List price
	mm	inch					
	0 - 25	0 - 1	0.5	6.5	0.006	0912 501	92.00
	25 - 50	1 - 2	0.5	6.5	0.006	0912 502	104.00
	50 - 75	2 - 3	0.5	6.5	0.007	0912 503	119.00
	75 - 100	3 - 4	0.5	6.5	0.007	0912 504	136.00
	100 - 125	4 - 5	0.5	6.5	0.008	0912 505	149.00
	125 - 150	5 - 6	0.5	6.5	0.008	0912 506	164.00
	150 - 175	6 - 7	0.5	6.5	0.009	0912 507	176.00
	175 - 200	7 - 8	0.5	6.5	0.009	0912 508	190.00

## 0912 Set of digital micrometers



### Delivery

- Includes 4 micrometers
- Incl. setting gauges 25/50/75 mm
- Wooden case



Icon	Measuring range	Pitch	Spindle dia.	Order no.	List price
	mm	mm	mm		EUR
	0 - 100	0.5	6.5	0912 521	491.00



## 1866 Digital micrometers IP65



1866 410



1866 510



### Model

- Reading: 0.001 mm / .00005 inch
- Protection class IP65
- LCD display: 10 mm
- Rapid drive
- Carbide measuring faces
- Spindle stainless, hardened and smoothed
- Frame lacquered
- Thermally insulated
- Factory standard

### Functions

- ON / OFF
- **Quick-Start**
- **Quick-Lock** (key lock)
- Set to zero at any point
- mm / inch switching
- ABS (display can be set to zero without losing the ORIGIN)
- Hold

### ▪ Additionally 1866 5xx:

- ORIGIN (Preset value)
- Variable data output USB + Digimatic
- TOL (tolerance value input)

### Delivery

- Plastic case
- From measuring range 25 mm upwards includes a setting standard

✕	📏	Measuring range		Pitch mm	Spindle dia. mm	Error limit mm	Order no.	List price EUR
		mm	inch					
<b>Without data output</b>								
		0 - 25	0 - 1	0.5	6.5	0.002	1866 410	234.00
		25 - 50	1 - 2	0.5	6.5	0.002	1866 413	305.00
		50 - 75	2 - 3	0.5	6.5	0.003	1866 417	387.00
		75 - 100	3 - 4	0.5	6.5	0.003	1866 420	441.00
<b>With DataVariable bidirectional</b>								
		0 - 25	0 - 1	0.5	6.5	0.002	1866 510	281.00
		25 - 50	1 - 2	0.5	6.5	0.002	1866 513	337.00
		50 - 75	2 - 3	0.5	6.5	0.003	1866 517	439.00
		75 - 100	3 - 4	0.5	6.5	0.003	1866 520	491.00



1998801

1998802

### Accessories

	Order no.	List price EUR
Data cable bidirectional DataVariable to USB	1998 801	111.00
Data cable bidirectional DataVariable to Digimatic	1998 802	96.00



HELIOS • PREISSER

1866i Digital micrometers IP65 with integrated wireless



1866 41060



**integrated  
IW wireless**  
Wireless Data Transmission

2

**Model**

- Reading: 0.001 mm / .00005 inch
- Protection class IP65
- LCD display: 10 mm
- Rapid drive
- Carbide measuring faces
- Spindle stainless, hardened and smoothed
- Frame lacquered
- Thermally insulated
- Factory standard

**Functions**

- ON / OFF
- **Quick-Start**
- **Quick-Lock** (key lock)
- Set to zero at any point
- mm / inch switching
- ABS (display can be set to zero without losing the ORIGIN)
- Hold
- ORIGIN (Preset value)
- TOL (tolerance value input)
- Integrated Wireless

**Delivery**

- Plastic case
- From measuring range 25 mm upwards includes a setting standard

Measuring range	Measuring range		Pitch	Spindle dia.	Error limit	Order no.	List price
	mm	inch					
0 - 25	0 - 1	0.5	6.5	0.002	1866 41060	292.00	
25 - 50	1 - 2	0.5	6.5	0.002	1866 41360	360.00	
50 - 75	2 - 3	0.5	6.5	0.003	1866 41760	439.00	
75 - 100	3 - 4	0.5	6.5	0.003	1866 42060	491.00	

**Accessories**

i-Stick USB-receiver for Integrated Wireless

Order no.

1998 780

List price

EUR  
108.00



1998780

More information on our i-series and Integrated Wireless on page 224

Integrated Wireless is intended to be sold within the European Economic Area only



## 1866i Digital micrometers IP65 linear 5 mm pitch



### Specification

- Reading: 0,001 mm / .00005 inch
- Protection class IP65
- LCD display: 10 mm
- **Rapid drive**
- Sliding spindle
- Carbide measuring faces
- Spindle stainless, hardened and smoothed
- Frame lacquered
- Thermally insulated
- Factory standard

### Functions

- ON / OFF
- **Quick-Start**
- **Quick-Lock** (key lock)
- Set to zero at any point
- mm / inch switching
- ABS (display can be set to zero without losing the ORIGIN)
- ORIGIN (Preset value)
- Hold
- TOL (tolerance value input)

- Variable data output (1866) USB + Digimatic
- Integrated Wireless (1866i)

### Delivery

- Plastic case
- From measuring range 25 mm upwards includes a setting standard

✕	📏	Measuring range		Pitch mm	Spindle dia. mm	Error limit mm	Order no.	List price EUR
		mm	inch					
<b>With DataVariable bidirectional</b>								
		0 - 25	0 - 1	5	6.5	0.002	1866 610	383.00
		25 - 50	1 - 2	5	6.5	0.002	1866 613	439.00
		50 - 75	2 - 3	5	6.5	0.003	1866 617	552.00
		75 - 100	3 - 4	5	6.5	0.003	1866 620	597.00
<b>With Integrated Wireless</b>								
		0 - 25	0 - 1	5	6.5	0.002	186661 060	394.00
		25 - 50	1 - 2	5	6.5	0.002	186661 360	450.00
		50 - 75	2 - 3	5	6.5	0.003	186661 760	563.00
		75 - 100	3 - 4	5	6.5	0.003	186662 060	608.00

Integrated Wireless is intended to be sold within the European Economic Area only

### Accessories



1998725

1998802

1998780

	Order no.	List price EUR
Data cable bidirectional DataVariable to USB	1998 801	111.00
Data cable bidirectional DataVariable to Digimatic	1998 802	96.00
i-Stick USB-receiver for Integrated Wireless	1998 780	108.00



## 1866 Digital micrometer BASIC



### Model

- Reading: 0.001 mm / .00005 inch
- Protection class IP40
- LCD display: 10 mm
- Rapid drive
- Carbide measuring faces
- Spindle stainless, hardened and smoothed
- Frame lacquered
- Thermally insulated
- Factory standard

### Functions

- ON / OFF
- **Quick-Start**
- **Quick-Lock** (key lock)
- Set to zero at any point
- mm / inch switching
- Hold

### Delivery

- Plastic case

Icon	Measuring range		Pitch mm	Spindle dia. mm	Error limit mm	Order no.	List price EUR
	mm	inch					
	0 - 25	0 - 1	0.5	6.5	0.002	1866 210	198.00

## 1866i Sets of digital micrometers



### Delivery

- Plastic case
- From measuring range 25 mm upwards includes a setting standard

Icon	Measuring range		Spindle dia. mm	Order no.	List price EUR
	mm	inch			
<b>With Integrated Wireless</b>					
	0 - 100	0 - 4	6.5	1866 42160	1567.00
<b>With DataVariable bidirectional</b>					
	0 - 100	0 - 4	6.5	1866 521	1533.00

### Accessories

	Order no.	List price EUR
Data cable bidirectional DataVariable to USB	1998 801	111.00
Data cable bidirectional DataVariable to Digimatic	1998 802	96.00
i-Stick USB-receiver for Integrated Wireless	1998 780	108.00



## 0849 Precision dial micrometers



0849 501

**DIN**  
**863-3**

### Model

- DIN 863-3
- Reading: 0.01 mm
- Reading on the dial: 1  $\mu$ m
- Reading parts are satin chrome finished
- Retraction stroke 1.5 mm

- Spindle made of hardened stainless steel
- Constant measuring force
- Locking lever
- Carbide measuring faces
- Thermally insulated

### Delivery

- Plastic case

$\nabla$	$\frac{1}{2}$	Measuring range mm	Pitch mm	Spindle dia. mm	Thimble dia. mm	Order no.	List price EUR
		0 - 25	0.5	7.5	17.5	0849 501	831.00
		25 - 50	0.5	7.5	17.5	0849 502	988.00

## 0850 Precision dial micrometers

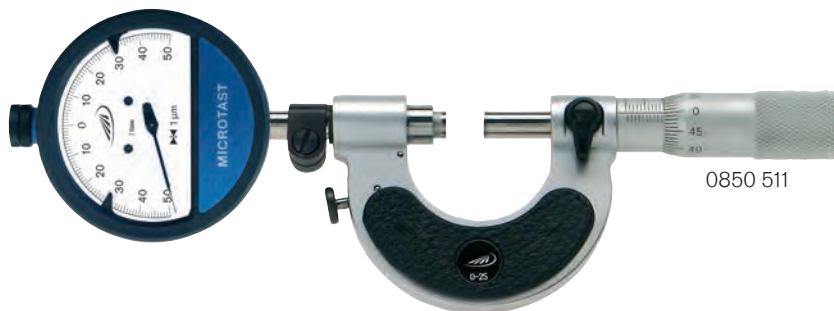

0850 511

**DIN**  
**863-3**

### Model

- DIN 863-3
- Reading: 0.01 mm
- Reading on the dial: 1  $\mu$ m
- Reading parts are satin chrome finished
- Retraction stroke 1.2 mm

- Locking lever
- Carbide measuring faces
- Constant measuring force
- Thermally insulated
- Spindle made of hardened stainless steel

- Adjustable tolerance markers

### Delivery

- Wooden case
- Incl. dial comparator gauge

$\nabla$	$\frac{1}{2}$	Measuring range mm	Pitch mm	Spindle dia. mm	Thimble dia. mm	Order no.	List price EUR
		0 - 25	0.5	7.5	17.5	0850 511	656.00
		25 - 50	0.5	7.5	17.5	0850 512	729.00
		50 - 100	0.5	7.5	17.5	0850 514	775.00
		100 - 150	0.5	7.5	17.5	0850 516	828.00
		150 - 200	0.5	7.5	17.5	0850 518	866.00





## 0822 Disc micrometers



### Model

- Factory standard
- Reading: 0.01 mm
- Carbide measuring faces
- Ratchet stop
- Disc dia. 60 mm
- Malleable cast iron frame, lacquered

### Delivery

- Wooden case

Measuring range mm	Pitch mm	Spindle dia. mm	Thimble dia. mm	Order no.	List price EUR
<b>Frame depth 50 mm</b>					
0 - 15	1	6.5	20	0822 301	108.00
0 - 25	1	6.5	20	0822 302	163.00
0 - 50	1	6.5	20	0822 303	299.00
<b>Frame depth 100 mm</b>					
0 - 50	1	6.5	20	0822 304	488.00

## 0824 Micrometers for tube wall measurement



**DIN**  
863-3

### Model

- DIN 863-3
- Reading: 0.01 mm
- Reading parts are satin chrome finished
- Ratchet stop
- Hardened measuring faces

- Malleable cast iron frame, lacquered

### Delivery

- Cardboard box

Measuring range mm	Pitch mm	Spindle dia. mm	Thimble dia. mm	Error limit mm	Order no.	List price EUR
<b>Ball dia. 2.5 mm</b>						
0 - 15	0.5	6.5	20	0.001	0824 302	219.00
<b>Ball dia. 6.5 mm</b>						
0 - 25	0.5	6.5	20	0.001	0824 303	221.00



## 0854 Blade micrometers



**DIN  
863-3**



### Model

- DIN 863-3
- Reading: 0.01 mm
- Reading parts are satin chrome finished

### Delivery

- Ratchet stop
- Thermally insulated
- Hardened spindle and anvil
- Coated steel frame
- Plastic case
- From measuring range 25 - 50 mm upwards includes a setting standard

⌘	¼	Measuring range mm	Pitch mm	Spindle dia. mm	Thimble dia. mm	Error limit mm	Order no.	List price EUR
<b>Measuring faces dia. 0.8 x 7 mm</b>								
		0 - 25	0.5	8	17.5	0.004	0854 301	290.00
		25 - 50	0.5	8	17.5	0.004	0854 302	352.00
		50 - 75	0.5	8	17.5	0.005	0854 303	377.00
		75 - 100	0.5	8	17.5	0.005	0854 304	410.00



## 0898 Settings gauges for micrometers



0898 104

### Model

- Rod
- Special steel, aged
- Hardened measuring faces
- Tolerance zone js2
- Thermally insulated
- Parallel lapped measuring faces

⊗	¼	Measuring range mm	Measuring surface dia. mm	Order no.	List price EUR
		25	6.5	0898 101	12.90
		50	6.5	0898 102	21.60
		75	6.5	0898 103	25.50
		100	6.5	0898 104	29.10
		125	6.5	0898 105	33.70
		150	6.5	0898 106	47.70
		175	6.5	0898 107	54.00
		200	6.5	0898 108	59.00
		225	6.5	0898 109	65.00
		250	6.5	0898 110	72.00
		275	6.5	0898 111	76.00
		300	10	0898 112	94.00
		325	10	0898 113	102.00
		350	10	0898 114	109.00
		375	10	0898 115	115.00
		400	10	0898 116	123.00
		425	10	0898 117	131.00
		450	10	0898 118	138.00
		475	10	0898 119	145.00

⊗	¼	Measuring range mm	Measuring surface dia. mm	Order no.	List price EUR
		500	10	0898 120	153.00
		525	10	0898 121	161.00
		550	10	0898 122	168.00
		575	10	0898 123	176.00
		600	10	0898 124	185.00
		625	10	0898 125	193.00
		650	10	0898 126	200.00
		675	10	0898 127	208.00
		700	10	0898 128	217.00
		800	10	0898 132	250.00
		900	10	0898 136	281.00
		1000	10	0898 140	313.00
	▪	1050	10	0898 142	327.00
	▪	1150	10	0898 146	359.00
	▪	1250	10	0898 150	394.00
	▪	1350	10	0898 154	424.00
	▪	1450	10	0898 158	457.00
	▪	1550	10	0898 162	732.00



## 0870 Precision micrometers for thread flank measurement



**DIN  
863-3**

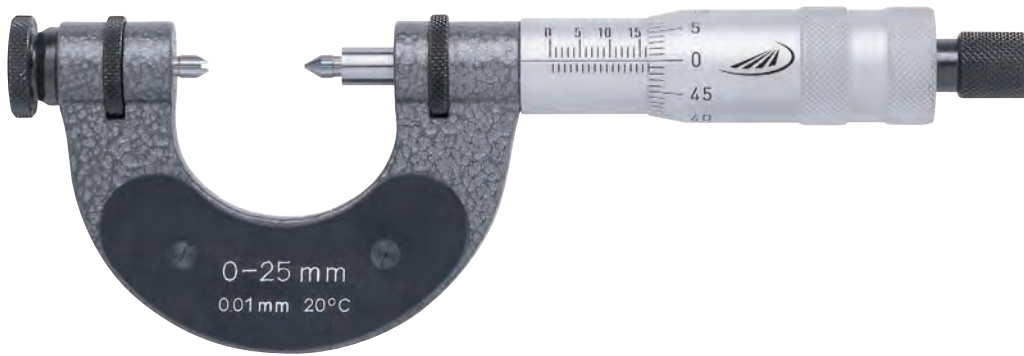

### Model

- DIN 863-3
- Reading 0.01 mm
- Reading parts are satin chrome finished
- Locking ring
- Ratchet stop
- Thermally insulated
- Spheroid ductile iron frame, lacquered

### Delivery

- Wooden case
- **Thread flank inserts and setting standards must be ordered separately**

✕	📏	Measuring range	Pitch	Thimble dia.	Error limit	Spindle adjustment	Required length of setting standard	Order no.	List price
		mm	mm	mm	mm	mm	mm		EUR
<b>For inserts with shank dimensions, dia. 3.5 x 13.5 mm</b>									
		0 - 25	0.5	20	0.004	25	-	0870 301	370.00
		25 - 50	0.5	20	0.004	25	25	0870 302	387.00
		50 - 75	0.5	20	0.005	25	50	0870 303	416.00
		75 - 100	0.5	20	0.005	25	75	0870 304	455.00
		100 - 125	0.5	20	0.006	25	100	0870 305	499.00
		125 - 150	0.5	20	0.006	25	125	0870 306	541.00
		150 - 200	0.5	20	0.007	50	175	0870 307	772.00
		200 - 250	0.5	20	0.008	50	225	0870 309	843.00
		250 - 300	0.5	20	0.009	50	275	0870 311	928.00



## 0870 Thread flank inserts for external measurement



### Model

- Made of hardened special steel and finely grinded
- Every insert is inscribed with the pitch details
- In a set (V-anvil + tapered anvil)
- Shank dimensions: 3.5 x 13.5 mm

Icon	Pitch angle in degrees	Pitch mm	Applicable for UNC, UNF 60°	Thread pitch in TPI mm	Order no.	List price EUR
<b>Metric ISO - threads</b>						
	60°	0.35 - 0.50	72 - 48		0870 901	140.00
	60°	0.60 - 0.80	44 - 32		0870 903	121.00
	60°	0.90 - 1.25	28 - 18		0870 905	121.00
	60°	1.5 - 2.0	16 - 11		0870 907	121.00
	60°	2.5 - 3.5	10 - 7		0870 909	121.00
	60°	4.0 - 6.0	6 - 4		0870 911	140.00
<b>Whitworth - threads</b>						
	55°			60 - 48	0870 921	153.00
	55°			40 - 32	0870 923	132.00
	55°			28 - 22	0870 925	132.00
	55°			20 - 16	0870 927	132.00
	55°			14 - 11	0870 929	132.00
	55°			10 - 7	0870 931	132.00
	55°			6 - 4	0870 933	153.00
<b>Metric ISO - Trapezoid threads (DIN 103)</b>						
	30°	1.5			0870 941	359.00
	30°	2.0			0870 943	261.00
	30°	3.0			0870 945	229.00
	30°	4.0			0870 947	229.00
	30°	5.0 - 6.0			0870 949	229.00
	30°	7.0 - 8.0			0870 951	229.00
	30°	9.0 - 10.0			0870 953	261.00
	30°	12.0 - 14.0			0870 955	359.00





## 0870 Thread flank setting gauges for external measurement



### Model

- Measuring faces made of hardened special steel
- One end is rounded, the lapped bore simplifies the fitting upon the conical insert
- Thermally insulated handle
- **Note: With trapezoid treads every pitch requires a separate setting standard**

		Length mm	Pitch angle in degrees	Available for following pitches mm	Error limit µm	Order no.	List price EUR
<b>Metric ISO - threads</b>							
		25	60°		3	0870 801	88.00
		50	60°		3	0870 802	90.00
		75	60°		3	0870 803	91.00
		100	60°		4	0870 804	92.00
		125	60°		4	0870 805	93.00
		175	60°		4	0870 807	103.00
		225	60°		4	0870 809	117.00
		275	60°		4	0870 811	128.00
<b>Whitworth - threads</b>							
		25	55°		3	0870 821	88.00
		50	55°		3	0870 822	90.00
		75	55°		3	0870 823	91.00
		100	55°		4	0870 824	97.00
		125	55°		4	0870 825	99.00
		175	55°		4	0870 827	113.00
		225	55°		4	0870 829	129.00
		275	55°		4	0870 831	148.00
<b>Metric ISO - Trapezoid threads (DIN 103)*</b>							
		25	30°	2 / 3 / 4 / 5 - 6 / 7 - 8 / 9 - 10	4	0870 841	192.00
		50	30°	2 / 3 / 4 / 5 - 6 / 7 - 8 / 9 - 10	4	0870 842	198.00
		75	30°	2 / 3 / 4 / 5 - 6 / 7 - 8 / 9 - 10	4	0870 843	203.00
		100	30°	3 / 4 / 5 - 6 / 7 - 8 / 9 - 10 / 12 - 14	5	0870 844	211.00
		125	30°	4 / 5 - 6 / 7 - 8 / 9 - 10 / 12 - 14	5	0870 845	229.00
		175	30°	4 / 5 - 6 / 7 - 8 / 9 - 10 / 12 - 14	5	0870 847	273.00
		225	30°	5 - 6 / 7 - 8 / 9 - 10 / 12 - 14	5	0870 849	333.00
		275	30°	5 - 6 / 7 - 8 / 9 - 10 / 12 - 14	5	0870 851	408.00

\* When ordering the respective pitch must be specified



## 0864 Disc micrometers to measure gear tooth



**DIN**  
**863-3**

### Model

- DIN 863-3
- Reading: 0.01 mm
- Reading parts are satin chrome finished
- Modul 0.8 - 6
- Ratchet stop
- Hardened measuring faces
- Locking ring
- Friction coupling
- Thermally insulated

### Delivery

- Wooden case

⌘	⌘	Measuring range mm	Disc dia. mm	Pitch mm	Thimble dia. mm	Error limit mm	Order no.	List price EUR
		0 - 25	25	0.5	20	0.004	0864 321	372.00
		25 - 50	25	0.5	20	0.004	0864 322	447.00
		50 - 75	25	0.5	20	0.005	0864 323	484.00
		75 - 100	25	0.5	20	0.005	0864 324	526.00
		100 - 125	25	0.5	20	0.006	0864 325	567.00
		125 - 150	25	0.5	20	0.006	0864 326	608.00
		150 - 175	25	0.5	20	0.007	0864 327	653.00
		175 - 200	25	0.5	20	0.007	0864 328	698.00

## 0890 Wire thickness micrometer



### Model

- Factory standard
- Reading: 0.01 mm
- Readings parts are satin chrome finished
- Ratchet stop
- Carbide measuring faces

### Delivery

- Cardboard box

⌘	⌘	Measuring range mm	Pitch mm	Spindle dia. mm	Thimble dia. mm	Order no.	List price EUR
		0 - 10	0.5	6	18	0890 511	78.00



## 0884 Internal micrometer with measuring jaws

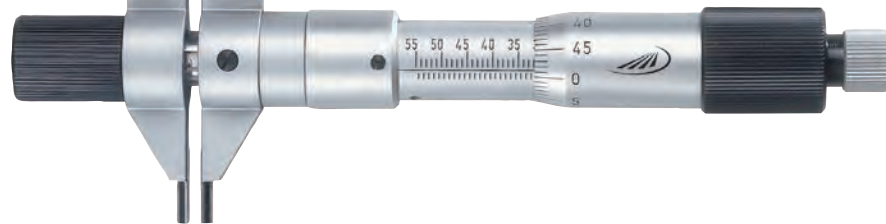
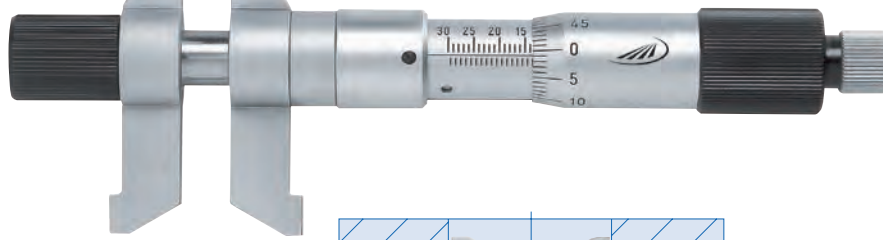

### Model

**DIN  
863-4**

- DIN 863-4
- Reading: 0.01 mm
- Reading parts are satin chrome finished
- Forward friction coupling
- Cylindrical carbide tipped measuring faces
- Measuring jaws on both sides (measuring ranges 5-30 mm, 30-55 mm)
- Divisions on both sides

### Delivery

- Wooden case

✕	¼	Measuring range mm	Thimble dia. mm	Pitch mm	Error limit µm	Order no.	List price EUR
		5 - 55	20	0.5	2.5	0884 501	998.00

## 0885 Internal micrometers with measuring jaws



0885 502

### Model

- Factory standard
- Reading: 0.01 mm
- Reading parts and body are satin chrome finished
- Ratchet stop
- Carbide measuring faces
- Cylindrical carbide tipped measuring faces

### Delivery

- Plastic case

✕	¼	Measuring range mm	Thimble dia. mm	Pitch mm	Order no.	List price EUR
		5 - 30	17	0.5	0885 501*	207.00
		25 - 50	17	0.5	0885 502	229.00
		50 - 75	17	0.5	0885 503	241.00
		75 - 100	17	0.5	0885 504	288.00
		100 - 125	17	0.5	0885 505	366.00
		125 - 150	17	0.5	0885 506	422.00
		150 - 175	17	0.5	0885 507	537.00
		175 - 200	17	0.5	0885 508	609.00





## 0888 Internal micrometers cylindrical version



### Model

**DIN**  
**863-4**

- DIN 863-4
- Reading: 0.01 mm
- Reading parts are satin chrome finished
- Carbide measuring faces dia. 6 mm, spherical lapped
- From measuring range 100 - 125 mm with thermal insulation

- From measuring range 100 - 125 mm with locking ring

### Delivery

- Wooden case

»	¼	Measuring range mm	Thimble dia. mm	Pitch mm	Error limit µm	Order no.	List price EUR
		25 - 30	15	0.5	4	0888 501	193.00
		30 - 35	15	0.5	4	0888 502	193.00
		35 - 50	15	0.5	4	0888 503	193.00
		50 - 75	16	0.5	5	0888 504	202.00
		75 - 100	17	0.5	5	0888 505	209.00
		100 - 125	20	0.5	6	0888 506	234.00
		125 - 150	20	0.5	6	0888 507	239.00
		150 - 175	20	0.5	7	0888 508	247.00
		175 - 200	20	0.5	7	0888 509	257.00
		200 - 225	20	0.5	8	0888 510	264.00
		225 - 250	20	0.5	8	0888 511	272.00
		250 - 275	20	0.5	9	0888 512	281.00
		275 - 300	20	0.5	9	0888 513	292.00
		300 - 325	20	0.5	10	0888 514	304.00
		325 - 350	20	0.5	10	0888 515	310.00
		350 - 375	20	0.5	11	0888 516	324.00
		375 - 400	20	0.5	11	0888 517	331.00
		400 - 425	20	0.5	12	0888 518	343.00
		425 - 450	20	0.5	12	0888 519	354.00
		450 - 475	20	0.5	13	0888 520	362.00
		475 - 500	20	0.5	13	0888 521	370.00

## 0888 Holder for internal micrometers



### Model

- Ideal for all internal micrometers from series 0888 / 0892
- Length 200 mm

»	¼	Order no.	List price EUR
		0888 101	62.00



## 0892 Internal micrometers with interchangeable extensions



DIN  
863-4



0892 501

### Model

- DIN 863-4
- Reading: 0.01 mm
- Reading parts are satin chrome finished

### Delivery

- Threaded extension rods with thermally insulated handle
- Carbide measuring faces, spherical lapped
- Wooden case

✂	☞	Measuring range	Thimble dia.	Pitch	Extensions	Error limit	Order no.	List price
		mm	mm	mm		µm		EUR
		50 - 150	17	0.5	25 / 50	6	0892 501	473.00
		50 - 250	17	0.5	25 / 50 / 100	8	0892 502	580.00
		50 - 450	17	0.5	25 / 50 / 100 / 200	10	0892 503	714.00
		50 - 850	17	0.5	25 / 50 / 100 / 200 / 400	12	0892 504	900.00
		50 - 1450	17	0.5	25 / 50 / 100 / 200 / 400 / 600	15	0892 505	1142.00

## 0892 Extensions for internal micrometers



0892 334

✂	☞	Length mm	Order no.	List price EUR
		25	0892 332	90.00
		50	0892 333	91.00
		100	0892 334	101.00
		200	0892 336	123.00
		400	0892 339	163.00
		600	0892 340	229.00



## 0894 Precision internal micrometers with extensions

DIN 863-4

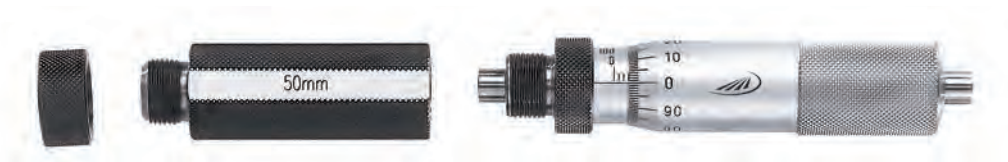

### Model

- DIN 863-4
- Measuring ends: dia. 7 mm x 6 mm long, carbide tipped spherical lapped
- Thread pitch 1 mm
- Internal spring mounted rods with thermal protective sleeves

- Extensions greater than 100 mm: external steel tube dia. 17 mm, with thermal insulation
- Extensions 500 and 1000 mm: strengthened specification - steel tube dia. 32 mm

- Basic internal micrometer is adjustable: 50 mm. The spindle is tight, so that during measurement the thimble does not adjust itself.

### Delivery

- Wooden case

✕	⊘	Measuring range mm	Length of extensions mm (tube dia. 17 mm)	Length of extensions mm (tube dia. 32 mm)	Error limit μm	Order no.	List price EUR
		100 - 150	only micrometer, excludes case	-	4	0894 504	281.00
		100 - 300	50 / 100	-	7	0894 510	748.00
		100 - 500	50 / 100 / 200	-	9	0894 514	1009.00
		100 - 900	50 / 100 / 200 / 400	-	11	0894 518	1303.00
		100 - 1300	50 / 100 / 200 / 400 / 400	-	13	0894 522	1604.00
		100 - 1700	50 / 100 / 200 / 400 / 800	-	15	0894 526	1650.00
		100 - 2100	50 / 100 / 200 / 400 / 400 / 800	-	18	0894 530	1936.00
		100 - 2500	50 / 100 / 200 / 400 / 800 / 800	-	21	0894 534	1987.00
		100 - 2000	50 / 100 / 200 / 200	500 / 1 x 1000	18	0894 538	3469.00
		100 - 3000	50 / 100 / 200 / 200	500 / 2 x 1000	30	0894 542	4525.00
		100 - 4000	50 / 100 / 200 / 200	500 / 3 x 1000	40	0894 546	5617.00
	▪	100 - 5000	50 / 100 / 200 / 200	500 / 4 x 1000	50	0894 550	6673.00
	▪	100 - 6000	50 / 100 / 200 / 200	500 / 5 x 1000	60	0894 554	7731.00

With the larger measuring ranges we recommend that the ends of the precision internal micrometer to be placed and/or held on 2 points with an approximate distance of 22% of the measuring length, thus minimizing deflection. The error indicated in the table above refers to the maximum deflection of the appropriate set. When smaller dimensions are measured, the error is smaller and corresponds to the error value of the smaller sets.

## 0894 Individual extensions



✕	⊘	Length mm	Tube dia. mm	Order no.	List price EUR
		50	17	0894 804	202.00
		100	17	0894 806	229.00
		200	17	0894 810	247.00
		400	17	0894 820	273.00
		800	17	0894 834	310.00
		500	32	0894 854	1019.00
		1000	32	0894 872	1058.00



## 1921 3 point internal micrometers



**DIN  
863-4**



1921 512



1921 534

### Model

- DIN 863-4
- Reading: 0.001 mm\*
- Reading: 0.005 mm
- Reading parts are satin chrome finished
- Pitch 0.5 mm
- Carbide tipped measuring pins from measuring range 12 mm

### Delivery

- Plastic case
- Incl. setting ring
- Calibration certificate for ring and micrometer



**Inclusive!**

✕	☒	Measuring range mm	Measuring depth mm	Thimble dia. mm	Error limit µm	Order no.	List price EUR
▪		6 - 8	58	16	4	1921 510*	449.00
▪		8 - 10	58	16	4	1921 512*	449.00
▪		10 - 12	58	16	4	1921 514*	449.00
▪		12 - 16	64	16	4	1921 516*	449.00
▪		16 - 20	64	16	4	1921 518*	476.00
▪		20 - 25	68	25	4	1921 520	488.00
▪		25 - 30	68	25	4	1921 522	495.00
▪		30 - 40	76	25	4	1921 524	556.00
▪		40 - 50	76	25	4	1921 526	556.00
▪		50 - 60	79	25	5	1921 528	641.00
▪		60 - 70	79	25	5	1921 530	660.00
▪		70 - 85	97	25	5	1921 532	678.00
▪		85 - 100	97	25	5	1921 534	696.00
▪		100 - 125	132	25	6	1921 536	976.00
▪		125 - 150	132	25	6	1921 538	1153.00
▪		150 - 175	132	25	7	1921 540	1214.00
▪		175 - 200	132	25	7	1921 542	1282.00



## 1920 Set of 3 point internal micrometers



**DIN  
863-4**



### Model

- DIN 863-4
- Reading: 0.001 mm\*
- Reading: 0.005 mm
- Reading parts are satin chrome finished
- Pitch 0.5 mm
- Carbide tipped measuring pins from measuring range 12 mm
- Ratchet stop
- From measuring range 12 mm for through and blind holes

### Delivery

- Plastic case
- Incl. setting ring
- Calibration certificate for ring and micrometer

2

⌘	⚙	Measuring range mm	Thimble dia. mm	Number of devices	Order no.	List price EUR
▪		6 - 12	16	3	1920 574	1270.00
▪		12 - 20	16	2	1920 576	891.00
▪		20 - 50	25	4	1920 578	2197.00
▪		50 - 100	25	4	1920 580	2624.00

## 1920 Measuring depth extensions for 3 point internal micrometers



### Model

- Suitable for devices 1920, 1921, 1923 and 1924



⌘	⚙	Measuring range mm	Length mm	Order no.	List price EUR
		6 - 12	75	1920 910	104.00
		12 - 20	75	1920 914	111.00
		20 - 30	100	1920 920	117.00
		30 - 200	100	1920 924	140.00



## 1923 DIGI-MET® 3 point internal micrometers



### Model

- DIN 863-4
- Reading: 0.001 mm / .00005 inch
- Protection class IP52
- LCD display 8.5 mm
- Ratchet stop
- For through holes
- From measuring range 12 mm for through and blind holes
- From measuring range 12 mm with carbide tipped measuring faces

### Functions

- ON / OFF
- Set to zero at any point
- mm / inch switching
- ABS (display can be set to zero without losing the Preset value)
- **Quick-Lock** (key lock)
- PRESET-Function (setting a numerical value)
- Variable data output RS 232 + Digimatic + USB

### Delivery

- Plastic case
- Incl. setting ring
- Calibration certificate for setting ring and micrometer



Inclusive!

✕	☒	Measuring range mm	Measuring depth mm	Error limit µm	Order no.	List price EUR
▪		6 - 8	58	4	1923 510	1239.00
▪		8 - 10	58	4	1923 512	1239.00
▪		10 - 12	58	4	1923 514	1251.00
▪		12 - 16	64	4	1923 516	1251.00
▪		16 - 20	64	4	1923 518	1304.00
▪		20 - 25	68	4	1923 520	1327.00
▪		25 - 30	68	4	1923 522	1339.00
▪		30 - 40	76	4	1923 524	1398.00
▪		40 - 50	76	4	1923 526	1404.00
▪		50 - 60	79	5	1923 528	1510.00
▪		60 - 70	79	5	1923 530	1544.00
▪		70 - 85	97	5	1923 532	1579.00
▪		85 - 100	97	5	1923 534	1639.00
▪		100 - 125	132	6	1923 536	1991.00
▪		125 - 150	132	6	1923 538	2226.00
▪		150 - 175	132	7	1923 540	2397.00
▪		175 - 200	132	7	1923 542	2602.00



1998720



1998501



1997501

### Accessories

- Data cable DATA VARIABLE to RS232
- Data cable DATA VARIABLE to digimatic
- Data cable DATA VARIABLE to USB

### Order no.

- 1997 501
- 1998 501
- 1998 720

### List price EUR

- 57.00
- 73.00
- 82.00



# HELIOS · PREISSER

## 1923 DIGI-MET® Set of 3 point internal micrometers



### Delivery

- Plastic case
- Incl. setting ring
- Calibration certificate for setting ring and micrometer



Measuring range	Error limit	Number of devices	Order no.	List price
				EUR
6 - 12	4 $\mu\text{m}$	3	1923 574	1996.00
12 - 20	4 $\mu\text{m}$	2	1923 576	1762.00
20 - 50	4 $\mu\text{m}$	4	1923 578	2584.00
50 - 100	5 $\mu\text{m}$	4	1923 580	3171.00



1998720



1998501



1997501

### Accessories

	Order no.	List price
		EUR
Data cable DATA VARIABLE to RS232	1997 501	57.00
Data cable DATA VARIABLE to digimatic	1998 501	73.00
Data cable DATA VARIABLE to USB	1998 720	82.00

## 1923 DIGI-MET® Basic unit for 3 point internal micrometers



### Model

- Reading: 0.001 mm / .00005 inch
- Protection class IP52
- LCD display 8,5 mm
- Ratchet stop
- Mounting thread for changing of measuring heads

### Functions

- ON / OFF
- Set to zero at any point
- mm / inch switching
- ABS (display can be set to zero without losing the Preset value)
- Quick-Lock (key lock)
- PRESET-Function (setting a numerical value)
- Variable data output RS 232 + Digimatic + USB

Measuring range	Order no.	List price
mm		EUR
6 - 20	1923 100	899.00
20 - 100	1923 200	899.00
100 - 200	1923 300	899.00

Single measuring heads on page 116



## 1924 DIGI-MET® 3 point internal measuring pistols



### Model

- For through holes
- Mounting thread for changing of measuring heads
- From measuring range 12 mm for through and blind holes
- From measuring range 12 mm with carbide tipped measuring faces
- Digital indicator recommended as display device

### Delivery

- Plastic case
- Incl. setting ring
- Without display device
- Calibration certificate  
**for setting ring** included



**Inclusive!**

⌘	⚙	Measuring range mm	Measuring depth mm	Order no.	List price EUR
▪		6 - 8	58	1924 510	922.00
▪		8 - 10	58	1924 512	922.00
▪		10 - 12	58	1924 514	934.00
▪		12 - 16	64	1924 516	946.00
▪		16 - 20	64	1924 518	981.00
▪		20 - 25	68	1924 520	981.00
▪		25 - 30	68	1924 522	1016.00
▪		30 - 40	76	1924 524	1069.00
▪		40 - 50	76	1924 526	1075.00
▪		50 - 60	79	1924 528	1169.00
▪		60 - 70	79	1924 530	1215.00
▪		70 - 85	97	1924 532	1257.00
▪		85 - 100	97	1924 534	1316.00
▪		100 - 125	132	1924 536	1621.00
▪		125 - 150	132	1924 538	1868.00
▪		150 - 175	132	1924 540	1996.00
▪		175 - 200	132	1924 542	2232.00



1726506

172650660

### Accessories

- DIGI-MET® Indicator
- DIGI-MET® Indicator with integrated wireless

Order no.

1726 506

172650 660

List price  
EUR

429.00

479.00

Calibration certificate for pistol and head only possible in combination with an Indicator





## 1924 DIGI-MET® Set of 3 point internal measuring pistols



### Model

- For through holes
- From measuring range 12 mm for through and blind holes
- From measuring range 12 mm with carbide tipped measuring faces
- Digital indicator recommended as display device

### Delivery

- Plastic case
- Incl. setting ring
- Without display device
- Calibration certificate **for setting ring** included

Measuring range mm	Number of devices	Order no.	List price EUR
6 - 12	3	1924 574	1645.00
12 - 20	2	1924 576	1409.00
20 - 50	4	1924 578	2349.00
50 - 100	4	1924 580	3054.00

Calibration certificate for pistol and head on request, only possible in combination with an Indicator

## 1924 DIGI-MET® Basic unit for 3 point internal measuring pistols



### Model

- Mounting thread for changing of measuring heads
- Support for indicators with shaft Ø 8 mm
- Measuring range 6-100 mm incl. adapter for 6-20 mm

### Delivery

- Plastic case

Measuring range mm	Order no.	List price EUR
6 - 100	1924 100	564.00
20 - 100	1924 200	564.00
100 - 200	1924 300	659.00

### Accessories

Accessories	Order no.	List price EUR
Replacement adapter 6-20 mm for measuring pistol 1924 100	1924 190	90.00

Single measuring heads on page 90



## 1922 Individual measuring heads for 1923 / 1924



1922 512



1922 534

### Model

- Self centering measuring head with three anvils, offset at intervals of 120°
- From measuring range 12 mm with carbide tipped measuring faces
- From measuring range 12 mm for through and blind holes
- From measuring range 40 mm, measuring heads are made of aluminium to reduce weight
- Can only be used on digital internal micrometers

✂	📏	Measuring range mm	Order no.	List price EUR
		6 - 8	1922 510	341.00
		8 - 10	1922 512	341.00
		10 - 12	1922 514	346.00
		12 - 16	1922 516	346.00
		16 - 20	1922 518	359.00
		20 - 25	1922 520	370.00
		25 - 30	1922 522	383.00
		30 - 40	1922 524	429.00
		40 - 50	1922 526	429.00
		50 - 60	1922 528	511.00
		60 - 70	1922 530	523.00
		70 - 85	1922 532	540.00
		85 - 100	1922 534	558.00
		100 - 125	1922 536	816.00
		125 - 150	1922 538	992.00
		150 - 175	1922 540	1075.00
		175 - 200	1922 542	1111.00

## 1920 Measuring depth extensions for 3 point internal micrometers



### Model

- Suitable for devices 1920, 1921, 1923 and 1924



✂	📏	Measuring range mm	Length mm	Order no.	List price EUR
		6 - 12	75	1920 910	104.00
		12 - 20	75	1920 914	111.00
		20 - 30	150	1920 920	117.00
		30 - 200	150	1920 924	140.00



## 0882 Depth micrometers



DIN  
863-2

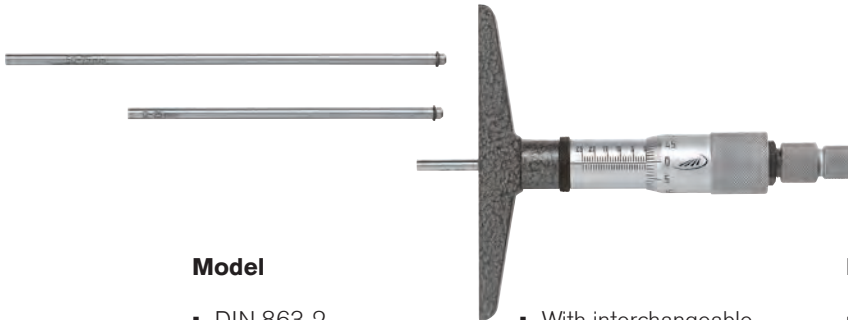

### Model

- DIN 863-2
- Reading: 0.01 mm
- Reading parts are satin chrome finished
- Locking ring
- Friction coupling

### Delivery

- Wooden case

- With interchangeable steel measuring inserts dia. 4 mm
- Hardened measuring faces

»	¼	Measuring range mm	Length of beam mm	Pitch mm	Thimble dia. mm	Error limit mm	Order no.	List price EUR
<b>Measuring faces dia. 0.8 mm, length 8.5 mm</b>								
		0 - 50	50	0.5	20	0.004	0882 300	331.00
		0 - 75	50	0.5	20	0.005	0882 301	360.00
		0 - 100	100	0.5	20	0.005	0882 303	395.00
		0 - 150	100	0.5	20	0.006	0882 304	463.00
		0 - 300	100	0.5	20	0.009	0882 306	744.00

## 0886 Micrometer heads



DIN  
863-2



0886 503

### Model

- DIN 863-2
- Reading: 0.01 mm
- Reading parts are satin chrome finished
- Carbide measuring faces

### Delivery

- Plastic case



0886 507

»	¼	Measuring range mm	Spindle dia. mm	Thimble dia. mm	Attachement dia. mm	Error limit mm	Description	Order no.	List price EUR
		0 - 6.5	3.5	9.5	6.0	0.003	without ratchet stop	0886 503	27.50
		0 - 13	6.5	13.5	9.5	0.003	without ratchet stop	0886 505	31.70
		0 - 25	6.5	18	12	0.003	with ratchet stop	0886 507	27.50
		0 - 25	8	18	12	0.003	ratchet stop, non-rotating spindle	0886 513	48.80



# SAMPLES INDICATORS

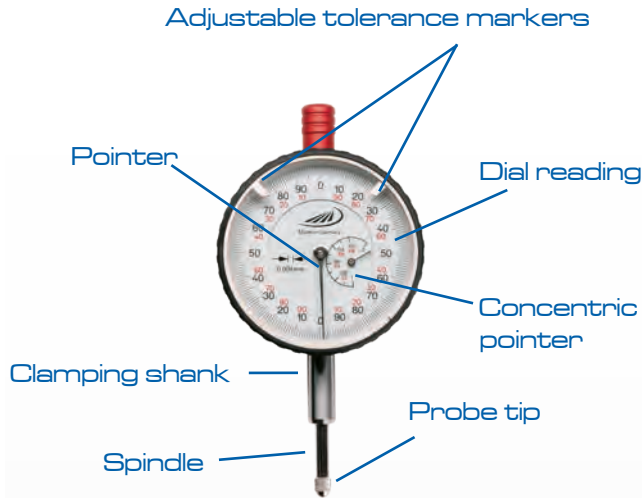

## Specifications

- Housing made from metal or polyamide
- Replacement probe tips M 2.5
- Shockproof devices available
- Water and oil proof devices available

## Electronic functions

**QuickStart Electronic:**  
Moving the spindle starts your measurement



**QuickLock Function:**  
Single keys can be locked individually



**Data Variable:**  
Interface for USB, RS 232 & Digimatic



**Integrated data transmission**  
(Integrated Wireless)



Individual tolerance limit values

Data Variable Interface



Combined analogue / digital display

# 1734i

with integrated wireless

## Matching accessories for our Indicators



MEASURING TABLES



MEASURING STANDS

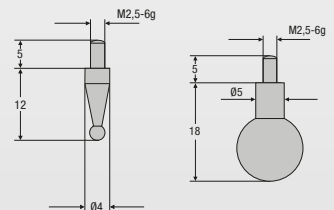

MEASURING INSERTS

### **3. CHAPTER INDICATORS**

<b>94</b>	<b>Indicators</b>
<b>100</b>	<b>Dial gauges</b>
<b>105</b>	<b>Precision indicators</b>
<b>106</b>	<b>Accessories for dial gauges and precision indicators</b>
<b>108</b>	<b>Measuring inserts for dial gauges</b>
<b>112</b>	<b>Dial test indicators</b>
<b>113</b>	<b>Dial thickness gauge</b>
<b>114</b>	<b>Internal bore gauges for blind holes</b>
<b>115</b>	<b>Crankshaft gauges / Length measuring instruments</b>
<b>116</b>	<b>Comparator gauge UHRTAST</b>
<b>122</b>	<b>Magnetic measuring stands</b>
<b>126</b>	<b>Measuring tables</b>
<b>129</b>	<b>Bench centres</b>
<b>136</b>	<b>Shaft measuring instruments</b>



## 1722 / 1723 / 1724 DIGI-MET® Indicators



1722 502



1723 502



1724 502

### Model

- Outer ring (Bezel) Ø 60 mm
- Replacement probe tip M 2.5
- Protection class IP52
- Clamping shank Ø 8 mm
- LCD display with 12 mm high numerals
- Accuracy according to factory standard

### Functions

- ON / OFF
- **Quick-Start**
- **Quick-Lock** (key lock)
- Set to zero at any point
- Reversal of counting direction
- mm / inch switching
- Individual key lock

### Delivery

- Cardboard box

- PRESET-Function (setting a numerical value)
- Variable data output RS 232 + Digimatic + USB

Measuring span	Resolution		Error limit	Measuring force	Order no.	List price
	mm	inch				
12.5	0.01	.0005	0.02	0.5 - 1	1722 502	161.00
12.5	0.005	.0001	0.015	0.5 - 1	1723 502	202.00
12.5	0.001	.00005	0.005	0.5 - 1	1724 502	334.00



1998720

1997501

1998501

### Accessories

	Order no.	List price
Data cable Data Variable to USB	1998 720	82.00
Data cable Data Variable to RS232	1997 501	57.00
Data cable Data Variable to digimatic	1998 501	73.00
Cable release (12,5 mm)	1739 920	16.80



## 1726 / 1728 DIGI-MET® Indicators



1726 502



1728 502

### Model

- Aluminium housing
- Hardened stainless steel spindle
- Outer ring (Bezel) Ø 60 mm
- Replacement probe tip M 2.5
- Protection class IP42
- Clamping shank Ø 8 mm
- Display unit can be rotated through 280°
- LCD display with 11 mm high numerals
- Factory standard

### Functions

- ON / OFF
- Quick-Start
- Quick-Lock (key lock)
- Set to zero at any point
- mm / inch switching
- ABS (display can be set to zero without losing the Preset value)
- TOL (tolerance value input)
- Reversal of counting direction
- Factor input

### Delivery

- Cardboard box

Measuring span	Resolution		Error limit		Repeatability	Measuring force	Order no.	List price	
	mm	mm	inch	total span mm					partial span** mm
<b>Reading 0.001 mm</b>									
12.5	0.001*	.00005		0.004	0.002	0.001	0.65 - 0.9	1726 502	389.00
25	0.001*	.00005		0.004	0.002	0.001	0.65 - 1.15	1726 506	429.00
50	0.001*	.00005		0.007	0.002	0.001	1.25 - 2.7	1726 510	754.00
100	0.001*	.00005		0.008	0.002	0.001	1.6 - 3.5	1726 514	934.00
<b>Reading 0.01 mm</b>									
12.5	0.01	.0005		0.02		0.01	0.65 - 0.9	1728 502	326.00
25	0.01	.0005		0.02		0.01	0.65 - 1.15	1728 506	415.00
50	0.01	.0005		0.02		0.01	1.25 - 2.7	1728 510	677.00
100	0.01	.0005		0.02		0.01	1.6 - 3.5	1728 514	866.00

\* Reading switchable: 0.0005 / 0.001 / 0.002 / 0.005 / 0.010 mm

\*\* Partial span = 25 steps by step value 0.0005 mm



1998720

1998501

1997501

### Accessories

	Order no.	List price EUR
Data cable Data Variable to USB	1998 720	82.00
Data cable Data Variable to RS232	1997 501	57.00
Data cable Data Variable to digimatic	1998 501	73.00
Cable release (12,5 mm)	1739 910	45.10



## 1730 DIGI-MET® Indicators



### Model

- Aluminium housing
- Outer ring (Bezel) Ø 60 mm
- Replacement probe tip M 2.5
- Protection class IP54
- Clamping shank Ø 8 mm
- Display unit can be rotated through 280°
- LCD display with 11 mm high numerals
- Factory standard

### Functions

- ON / OFF
- Quick-Start**
- Quick-Lock** (key lock)
- Set to zero at any point
- mm / inch switching
- ABS (display can be set to zero without losing the Preset value)
- TOL (tolerance value input)
- Reversal of counting direction

### Delivery

- Cardboard box

Measuring span	Resolution		Error limit		Repeatability	Measuring force	Order no.	List price
	mm	mm	inch	total span mm				
12.5	0.001	.00005	0.004	0.002	0.001	0.65 - 0.9	1730 502	431.00
25	0.001	.00005	0.004	0.002	0.001	0.65 - 1.15	1730 506	486.00

\* Reading switchable: 0.0005 / 0.001 / 0.002 / 0.005 / 0.010 mm

\*\* Partial span= 25 steps by step value 0.0005 mm



1998720      1998501      1997501

### Accessories

	Order no.	List price
Data cable Data Variable to USB	1998 720	82.00
Data cable Data Variable to RS232	1997 501	57.00
Data cable Data Variable to digimatic	1998 501	73.00
Cable release (12,5 mm)	1739 910	45.10





## 1734 DIGI-MET® indicators with combined analogue / digital display



1734 502



1734 506

### Model

- Aluminium housing
- Hardened stainless steel spindle
- Outer ring (Bezel) Ø 60 mm
- Replacement probe tip M 2.5
- Protection class IP42
- Clamping shank Ø 8 mm
- Display unit can be rotated through 280°
- LCD display with 8.5 mm high numerals
- Factory standard

### Functions

- ON / OFF
- Quick-Start
- Quick-Lock (key lock)
- Set to zero at any point
- mm / inch switching
- ABS (display can be set to zero without losing the Preset value)
- TOL (tolerance value input)
- MIN / MAX
- TIR (MIN-MAX differential)
- Reversal of counting direction

### Delivery

- Cardboard box

Measuring span	Resolution		Error limit		Repeatability	Measuring force	Order no.	List price
	mm	inch	total span mm	partial span** mm				
12.5	0.001	.00005	0.004	0.002	0.001	0.65 - 0.9	1734 502	448.00
25	0.001	.00005	0.004	0.002	0.001	0.65 - 1.15	1734 506	513.00

\* Reading switchable: 0.0005 / 0.001 / 0.002 / 0.005 / 0.010 mm

\*\* Partial span= 25 steps by step value 0.0005 mm



1998720

1998501

1997501

### Accessories

	Order no.	List price EUR
Data cable Data Variable to USB	1998 720	82.00
Data cable Data Variable to RS232	1997 501	57.00
Data cable Data Variable to digimatic	1998 501	73.00
Cable release (12,5 mm)	1739 910	45.10



## 1734 DIGI-MET® indicator with combined analogue / digital display

for comparator gauges



1734 522

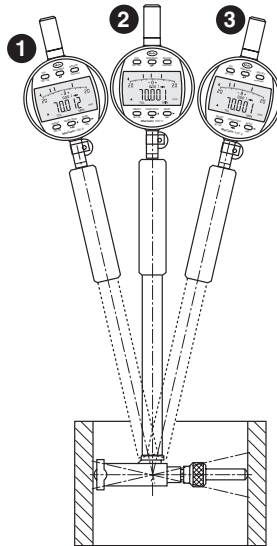

### Application

The turning point can be determined automatically in measurements with a 2 point internal measuring device through commuting. The actual value is detected and stored by the MIN function and appears on the display.

### Model

- Aluminium housing
- Hardened stainless steel spindle
- Outer ring (Bezel) Ø 60 mm
- Replacement probe tip M 2.5
- Protection class IP42
- Clamping shank Ø 8 mm
- Display unit can be rotated through 280°
- LCD display with 8.5 mm high numerals
- Factory standard

### Functions

- ON / OFF
- Quick-Start**
- Quick-Lock** (key lock)
- Set to zero at any point
- mm / inch switching
- ABS (display can be set to zero without losing the Preset value)
- TOL (tolerance value input)
- MIN / MAX
- Reversal of counting direction
- Factor input
- Individual key lock
- Variable data output RS 232 + Digimatic + USB
- PRESET-Function (setting a numerical value)

### Delivery

- Cardboard box

Measuring span	Resolution		Error limit		Repeatability	Measuring force	Order no.	List price
	mm	inch	total span mm	partial span** mm				
12.5	0.001	.00005	0.004	0.002	0.001	0.65 - 0.9	1734 522	581.00

\* Reading switchable: 0.0005 / 0.001 / 0.002 / 0.005 / 0.010 mm

\*\* Partial span = 25 steps by step value 0.0005 mm

### Accessories

	Order no.	List price
<b>Cable release (12,5 mm)</b>	<b>1739 910</b>	<b>45.10</b>
<b>Data cable Data Variable to RS232</b>	<b>1997 501</b>	<b>57.00</b>
<b>Data cable Data Variable to digimatic</b>	<b>1998 501</b>	<b>73.00</b>
<b>Data cable Data Variable to USB</b>	<b>1998 720</b>	<b>82.00</b>



1998720

1998501

1997501



## 1726i / 1734i DIGI-MET® Indicators with integrated wireless



1726 50260



1734 50260



## integrated IW wireless

Wireless Data Transmission



### Model

- Aluminium housing
- Outer ring (Bezel) Ø 60 mm
- Replacement probe tip M2.5
- Protection class IP42
- Clamping shank Ø 8mm
- Display can be rotated through 280°
- LCD display with 11 mm high numerals
- Factory standard

### Functions

- ON / OFF
- Quick-Start
- Quick-Lock (key lock)
- Set to zero at any point
- mm / inch switching
- ABS (display can be set to zero without losing the Preset value)
- TOL (tolerance value input)
- Reversal of counting direction

- Factor input
- Individual key lock
- PRESET-Function (setting a numerical value)
- Variable data output RS 232 + Digimatic + USB
- Integrated Wireless

### Delivery

- Cardboard box

More information on our i-series and Integrated Wireless on page 224

Measuring span	Resolution		Error limit		Repeatability	Measuring force	Order no.	List price
	mm	mm	inch	total span mm				
12.5	0.0005	.00002	0.004	0.002	0.001	0.65 - 0.9	1726 50260	441.00
25	0.0005	.00002	0.004	0.002	0.001	0.65 - 1.15	1726 50660	479.00
<b>With combined analogue / digital display and MIN / MAX / TIR Function</b>								
12.5	0.0005	.00002	0.004	0.002	0.001	0.65 - 0.85	1734 50260	498.00
25	0.0005	.00002	0.004	0.002	0.001	0.65 - 0.9	1734 50660	561.00

\* Reading switchable: 0.0005 / 0.001 / 0.002 / 0.005 / 0.010 mm  
 \*\* Partial span= 25 steps by step value 0.0005 mm

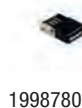

1998780

Accessories	Order no.	List price
Data cable Data Variable to USB	1998 720	82.00
Data cable Data Variable to RS232	1997 501	57.00
Data cable Data Variable to digimatic	1998 501	73.00
Cable release (12,5 mm)	1739 910	45.10
i-Stick USB-receiver for Integrated Wireless	1998 780	108.00

Integrated Wireless is intended to be sold in the European Economic Area only



## 0701 Small dial gauges with lightweight plastic housing



### Model

- Lightweight housing made of polyamide
- Measuring spindle is made of stainless steel
- Replacement probe tip M 2.5
- Clamping shank Ø 8 mm
- DIN 878

### Delivery

- Fitted case

DIN  
878

☒	☒	Measuring span mm	Scale graduation value mm	Range per rev. mm	Outer ring (Bezel) Ø mm	Order no.	List price EUR
		<b>Small dial gauge</b>					
		5	0.01	0.5	40	0701 101	51.00
		<b>Shockproof small dial gauge</b>					
		5	0.01	0.5	40	0701 102	64.00

## 0708 Small dial gauges



0708 101



0708 102

### Model

- Metal housing
- Measuring spindle is made of stainless steel
- Replacement probe tip M 2.5
- Clamping shank Ø 8 mm
- With a revolution counter
- DIN 878

### Delivery

- Fitted case

DIN  
878

☒	☒	Measuring span mm	Scale graduation value mm	Range per rev. mm	Outer ring (Bezel) Ø mm	Order no.	List price EUR
		10	0.01	1.0	40	0708 101	109.00
		5	0.01	0.5	40	0708 102	69.00
		3	0.01	0.5	32	0708 103	84.00
		3	0.01	0.5	40	0708 104	57.00
		<b>Shockproof small dial gauge</b>					
		3	0.01	0.5	40	0708 105	69.00
		5	0.01	0.5	40	0708 106	92.00



## 0701 Dial gauges



**DIN  
878**



0701 106



0701 110

### Model

- Measuring spindle is made of stainless steel
- Replacement probe tip M 2.5
- Clamping shank Ø 8 mm
- DIN 878
- 0701 103 = Factory standard

### Delivery

- Fitted case

☒ ☒	Measuring span mm	Scale graduation value mm	Range per rev. mm	Outer ring (Bezel) Ø mm	Order no.	List price EUR
<b>Dial gauge, plastic housing</b>						
	10	0.01	1	58	0701 103	27.10
<b>Dial indicator with shock protection, injection-molded housing</b>						
	10	0.01	1	58	0701 106	28.20
<b>Dial gauge, metal housing</b>						
	10	0.01	1	58	0701 110	47.00
<b>Shockproof dial gauge, metal housing</b>						
	10	0.01	1	58	0701 111	54.00

3

## 0703 Dial gauges with extended measuring range



0703 101

### Model

- Metal housing
- Measuring spindle is made of stainless steel
- Replacement probe tip M 2.5
- Clamping shank Ø 8 mm
- With a concentric pointer
- Factory standard

### Delivery

- Fitted case

☒ ☒	Measuring span mm	Scale graduation value mm	Range per rev. mm	Outer ring (Bezel) Ø mm	Order no.	List price EUR
	30	0.01	1	58	0703 101	124.00
	50	0.01	1	58	0703 104	173.00
	80	0.01	1	58	0703 107	346.00



## 0704 Shockproof dial gauges



**DIN  
878**



0704 105



0704 109

### Model

- Metal housing
- Measuring spindle is made of stainless steel
- Replacement probe tip M 2.5
- Clamping shank Ø 8 mm
- Shockproof

### Delivery

- Fitted case

☒	☒	Measuring span mm	Scale graduation value mm	Range per rev. mm	Outer ring (Bezel) Ø mm	Order no.	List price EUR
<b>Revolution counter: DIN 878</b>							
		10	0.01	1	58	0704 105	88.00
<b>With fine adjustment of the pointer: DIN 878</b>							
		10	0.01	1	58	0704 106	109.00
<b>Concentric pointer: Factory standard</b>							
		30	0.01	1	58	0704 109	143.00
		50	0.01	1	58	0704 110	184.00

## 0707 Water and oil proof dial gauges



**DIN  
878**



0707 102

### Model

- Metal housing, water and oil proof
- Protection class IP67
- Measuring spindle is made of stainless steel
- Replacement probe tip M 2.5
- Clamping shank Ø 8 mm
- Rubber bellows
- Shockproof
- Outer ring (Bezel) can be rotated through 360°
- DIN 878

### Delivery

- Fitted case

☒	☒	Measuring span mm	Scale graduation value mm	Range per rev. mm	Outer ring (Bezel) Ø mm	Order no.	List price EUR
		3	0.01	0.5	44.5	0707 101	156.00
		10	0.01	1	61.5	0707 102	133.00



## 0700 Dial gauges, graduation 0.1 mm



0700 102



0700 104

### Model

- Metal housing
- Measuring spindle is made of stainless steel
- Replacement probe tip M 2.5
- Clamping shank Ø 8 mm
- Factory standard

### Delivery

- Fitted case

	Measuring span mm	Scale graduation value mm	Range per rev. mm	Outer ring (Bezel) Ø mm	Order no.	List price EUR
	10	0.1	10	40	0700 100	76.00
	5	0.1	5	40	0700 101	76.00
	10	0.1	10	58	0700 102	58.00
<b>Straight line revolution counter</b>						
	30	0.1	10	58	0700 104	67.00

3

## 0702 Dial gauge with concentric mm display



0702 106

### Model

- Metal housing
- Measuring spindle is made of stainless steel
- Replacement probe tip M 2.5
- Clamping shank Ø 8 mm
- With a concentric pointer
- DIN 878

### Delivery

- Fitted case

DIN  
878

	Measuring span mm	Scale graduation value mm	Range per rev. mm	Outer ring (Bezel) Ø mm	Order no.	List price EUR
	10	0.01	1	58	0702 106	77.00



## 0705 Precision dial gauges



0705 102

### Model

- Metal housing
- Measuring spindle is made of stainless steel
- Replacement probe tip M 2.5
- Clamping shank  $\varnothing$  8 mm
- With a revolution counter
- Factory standard

### Delivery

- Fitted case

		Measuring span mm	Scale graduation value mm	Range per rev. mm	Outer ring (Bezel) $\varnothing$ mm	Order no.	List price EUR
		1	0.001	0.2	40	0705 102	137.00
		1	0.001	0.2	58	0705 104	137.00
		5	0.001	0.2	58	0705 105	143.00
<b>Precision shockproof dial gauge</b>							
		1	0.001	0.2	40	0705 107	145.00
		5	0.001	0.2	58	0705 109	176.00

## 0706 Error free, shockproof dial gauge



**DIN  
878**



0706 102

### Model

- Metal housing
- Measuring spindle is made of stainless steel
- Replacement probe tip M 2.5
- Clamping shank  $\varnothing$  8 mm
- DIN 878

### Delivery

- Fitted case

		Measuring span mm	Scale graduation value mm	Dial reading	Overtravel mm	Outer ring (Bezel) $\varnothing$ mm	Order no.	List price EUR
		0.8	0.01	40-0-40	1	58	0706 102	88.00





## 0709 Dial gauges with reverse action plunger



### Model

- Metal housing
- Measuring spindle is made of stainless steel
- Replacement probe tip M 2.5
- Clamping shank Ø 8 mm
- Factory standard

### Delivery

- Fitted case

☒ ☒	Measuring span	Scale graduation value	Range per rev.	Outer ring (Bezel)	Order no.	List price
	mm	mm	mm	Ø mm		EUR
	3	0.01	0.5	40	0709 101	131.00
	5	0.01	1	58	0709 108	156.00

3

## 0712 Dial comparator gauge MICROTAST



0712 121



0712 124

### Model

- Measuring spindle is made of hardened stainless steel
- Longer measuring spindle
- Replacement probe tip M 2.5
- Clamping shank Ø 8 mm
- Tolerance markers
- Shockproof
- Fine adjustment
- DIN 879

### Delivery

- Fitted case

DIN 879

☒ ☒	Measuring span	Scale graduation value	Dial reading	Overtravel	Order no.	List price
	mm	mm		mm		EUR
	0.5	0.01	25-0-25	2.5	0712 121	175.00
	0.1	0.001	50-0-50	3	0712 124	215.00



## 0710 Magnetic back



### Model

- For dial gauges with outer ring (Bezel) Ø 58 mm
- Allows dial gauges to be used without a holder or a stand
- Magnetic force 220 N
- Cannot be used in conjunction with dial gauges 0701103 and 0701106 or any digital gauges

		Order no.	List price EUR
		0710 101	60.00

## 0710 Lug back

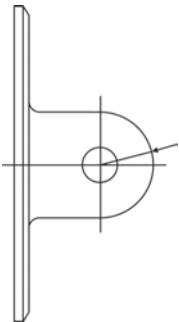

### Model

- Ø 5 mm
- For retrofitting
- Cannot be used in conjunction with dial gauges 0701103 and 0701106 or any digital gauges

		Diameter mm	Order no.	List price EUR
<b>For dial gauges with an outer ring (Bezel) dia. 40 mm</b>				
		5	0710 102	7.50
<b>For dial gauges with an outer ring (Bezel) dia. 58 mm</b>				
		5	0710 103	7.70

## 0710 Spindle lifting lever

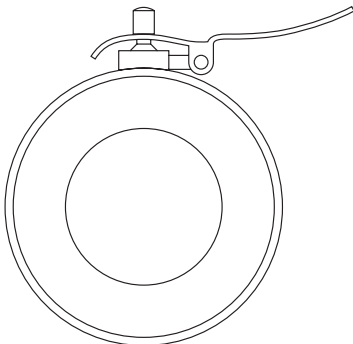

### Model

- For dial gauges with a measuring span of max. 10 mm
- Cannot be used in conjunction with dial gauges 0701103 and 0701106 or any digital gauges

		Diameter mm	Order no.	List price EUR
<b>For dial gauges with an outer ring (Bezel) dia. 40 mm</b>				
		5	0710 104	11.90
<b>For dial gauges with an outer ring (Bezel) dia. 58 mm</b>				
		5	0710 105	11.90



0710 Extensions for dial gauges



Model

- Special steel
- Thread M 2.5

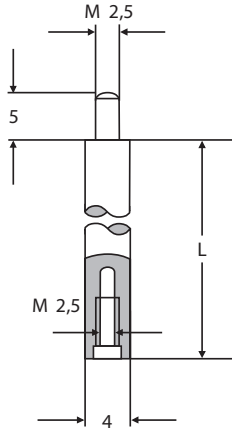

☒	☒	Length mm	Order no.	List price EUR
		10	0710 111	5.10
		15	0710 112	5.10
		20	0710 113	5.10
		25	0710 114	5.10
		30	0710 115	5.10
		35	0710 116	5.10
		40	0710 117	5.10
		45	0710 118	5.10
		50	0710 119	5.10
		55	0710 120	5.10
		60	0710 121	5.10
		65	0710 122	5.10
		70	0710 123	5.10
		75	0710 124	5.10
		80	0710 125	5.10
		85	0710 126	5.10
		90	0710 127	5.10
		95	0710 128	5.10
		100	0710 129	5.10

3



## 0710 Measuring inserts M 2.5

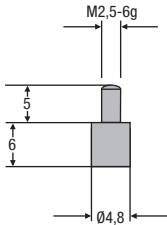

Material contact surface	Length mm	Order no.	List price EUR
Special steel	6	0710 161	4.90
Carbide	6	0710 261	33.60

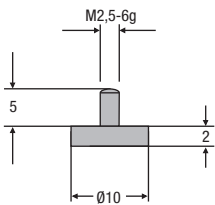

Material contact surface	Length mm	Order no.	List price EUR
Special steel	2	0710 162	6.40
Carbide	2	0710 262	55.00

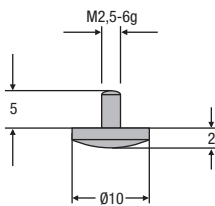

Material contact surface	Length mm	Order no.	List price EUR
Special steel	2	0710 163	7.40
Carbide	2	0710 263	85.00

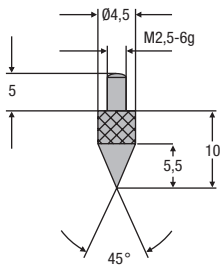

Material contact surface	Length mm	Order no.	List price EUR
Special steel	10	0710 164	7.40
Carbide	10	0710 264	64.00

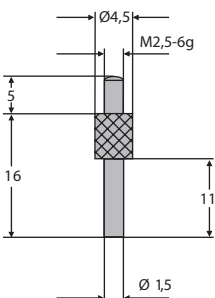

Material contact surface	Length mm	Diameter	Order no.	List price EUR
Special steel	16	1.5 mm	0710 165	9.30
Carbide	16	1.5 mm	0710 265	29.10



## 0710 Measuring inserts M 2.5

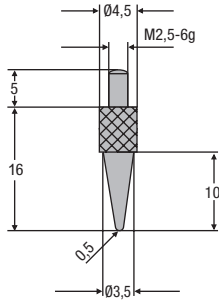

Material contact surface	Length mm	Order no.	List price EUR
Special steel	16	0710 166	6.70

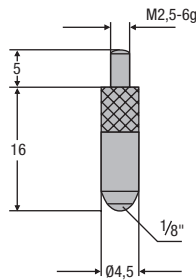

Material contact surface	Length mm	Order no.	List price EUR
Special steel	16	0710 167	4.70
Carbide	16	0710 267	15.50
Ruby	16	0710 367	12.10
Sapphire	16	0710 467	12.10

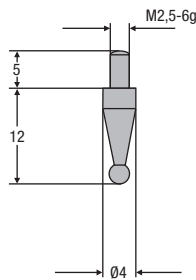

Material contact surface	Length mm	Ball diameter mm	Order no.	List price EUR
<b>Tolerance of the ball diameter +/- 1 µm</b>				
Special steel	12	1	0710 169	9.30
Special steel	12	1.5	0710 170	9.30
Special steel	12	2	0710 171	9.30
Special steel	12	2.5	0710 172	9.30
Special steel	12	3	0710 173	9.30
Special steel	12	3.5	0710 174	9.30
Special steel	12	4	0710 175	9.30
Special steel	12	4.5	0710 176	9.30
Special steel	12	5	0710 177	9.30
Special steel	12	5.5	0710 178	9.30
Special steel	12	6	0710 179	9.30
Special steel	12	6.5	0710 180	9.30

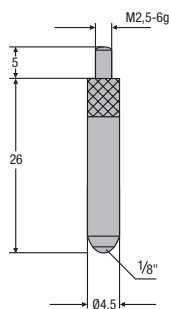

Material contact surface	Length mm	Order no.	List price EUR
Special steel	26	0710 168	4.70
Carbide	26	0710 268	15.50
Ruby	26	0710 368	12.10
Sapphire	26	0710 468	12.10



## 0710 Measuring inserts M 2.5

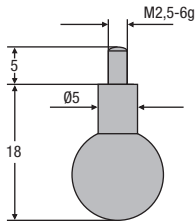

Material contact surface	Length mm	Ball diameter mm	Order no.	List price EUR
Special steel	18	7	0710 181	9.30
Special steel	18	7.5	0710 182	9.30
Special steel	18	8	0710 183	9.30
Special steel	18	8.5	0710 184	9.30
Special steel	18	9	0710 185	9.30
Special steel	18	9.5	0710 186	9.30
Special steel	18	10	0710 187	9.30
Special steel	18	10.5	0710 188	9.30
Special steel	18	11	0710 189	9.30

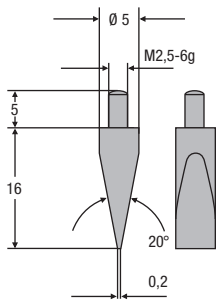

Material contact surface	Length mm	Order no.	List price EUR
<b>With locknut</b>			
Special steel	16	0710 192	11.40
Carbide	16	0710 292	81.00

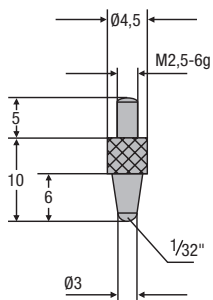

Material contact surface	Length mm	Order no.	List price EUR
Special steel	10	0710 193	4.90

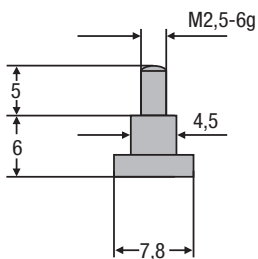

Material contact surface	Length mm	Order no.	List price EUR
Special steel	6	0710 194	6.70



## 0710 Measuring inserts M 2.5

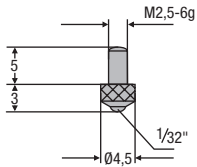

	Material contact surface	Length mm	Order no.	List price EUR
	Special steel	3	0710 195	1.70

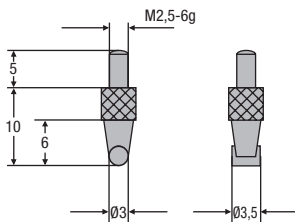

	Material contact surface	Length mm	Diameter mm	Order no.	List price EUR
<b>With locknut</b>					
	Special steel	10	3 x 3.5	0710 196	12.60

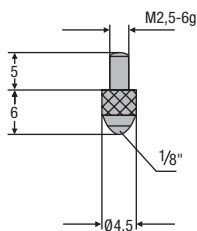

	Material contact surface	Length mm	Order no.	List price EUR
	Special steel	6	0710 197	1.50
	Carbide	6	0710 297	6.50
	Ruby	6	0710 397	9.10
	Sapphire	6	0710 497	9.10



## 0715 Dial test indicators



0715 101



0715 201

### Model

- Carbide tipped measuring inserts,  $\varnothing$  2.0 mm
- Form A in accordance to DIN 2270
- Revolving dial
- 3-piece swallow tail guide
- Automatic reversal of the counting direction
- Measuring force 0.15 N

### Delivery

- Fitted case

**DIN  
2270**

	Measuring range mm	Scale graduation value mm	Range per rev. mm	Stylus length mm	Dial reading	Outer ring (Bezel) $\varnothing$ mm	Order no.	List price EUR
	$\pm 0.4$	0.01	0.8	14.5	0-40-0	30	0715 101	91.00
	$\pm 0.4$	0.01	0.8	14.5	0-40-0	40.5	0715 103	102.00
	$\pm 0.25$	0.01	0.5	41.2	0-25-0	30	0715 201	143.00
	$\pm 0.1$	0.002	0.2	14.5	0-100-0	40.5	0715 303	128.00
	$\pm 0.1$	0.002	0.2	14.5	0-100-0	30	0715 305	121.00
	$\pm 0.5$	0.01	0.5	32.3	0-50-0	40.5	0715 307	181.00

## 0715 Clamping shanks for dial test indicators

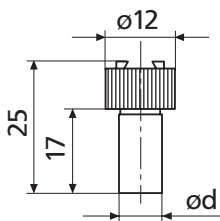

### Model

- With swallow tail mounting for dial test indicators and clamping nut

	Diameter	Order no.	List price EUR
	4h6	0715 903	13.70
	8h6	0715 907	13.70

## 0715 Measuring inserts with carbide ball

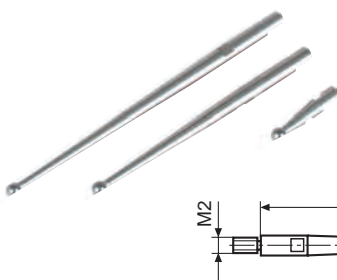

	Length mm	Ball diameter mm	Order no.	List price EUR
	14.5	1	0715 915	19.10
	14.5	2	0715 917	15.00
	14.5	3	0715 919	15.00
	32.3	1	0715 921	21.10
	32.3	2	0715 922	15.90
	32.3	3	0715 923	15.80
	41.2	1	0715 925	19.30
	41.2	2	0715 926	15.00
	41.2	3	0715 929	15.00





### 0715 Key for measuring inserts



Order no.	List price EUR
0715 940	2.90

### 0715 Universal clamp

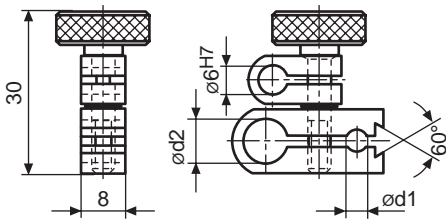

Diameter mm	Order no.	List price EUR
8	0715 950	28.60

### 0715 Holder

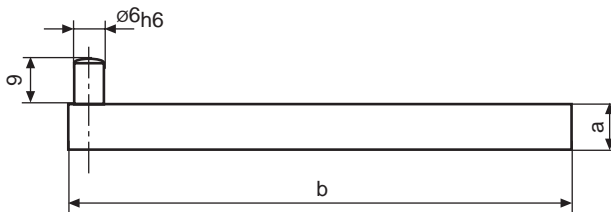

Length mm	Cross-section mm	Order no.	List price EUR
100	9 x 9	0715 955	18.10

### 0720 Foil thickness gauges



#### Model

- With a lifting device
- Factory standard
- Frame is made of aluminium alloy
- Revolution counter
- measuring insert dia. 6.35 mm, flat, thermally insulated

#### Delivery

- Cardboard box

Measuring range mm	Reading mm	Range per rev. mm	Throat depth mm	Order no.	List price EUR
0 - 1	0.001	0.2	30	0720 103	274.00



## 0728 Internal precision bore gauges for large and deep bores



### Model

- 2 point comparator measuring instrument with split probe + measuring pin
- Centering plate
- Mounting hole Ø 8 mm
- Ideal in conjunction with dial gauges or dial comparator gauges

### Delivery

- Wooden case
- Without dial gauge

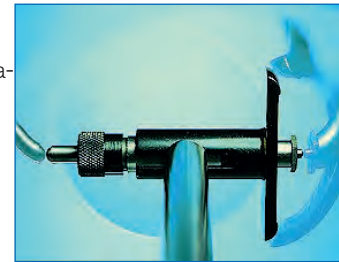

⌘	📏	Measuring range	Repeatability	Measuring depth	Measuring pins	Measuring discs	Order no.	List price EUR
		mm	µm	mm	pcs	pcs		
<b>Fixed measuring pins, hardened special steel, interchangeable contact pins are carbide tipped</b>								
		18 - 35	0.5	110	9	2	0728 105	468.00
		35 - 60	0.5	138	7	2	0728 106	455.00
		50 - 100	0.5	177	11	3	0728 107	520.00
		100 - 160	0.5	234	7	4	0728 108	725.00
		160 - 290	0.5	234	7	4	0728 109	1045.00
		280 - 510	1.5	400	7	4	0728 110	2466.00
<b>Fixed measuring pins and interchangeable contact pins, both pins are carbide tipped</b>								
		4.5 - 6	0.5	80	9		0728 201	1192.00
		6 - 8	0.5	100	7		0728 202	853.00
		8 - 12	0.5	100	9		0728 203	795.00
		12 - 20	0.5	110	9	1	0728 204	552.00
		18 - 35	0.5	110	9	2	0728 205	558.00
		35 - 60	0.5	138	7	2	0728 206	531.00
		50 - 100	0.5	177	11	3	0728 207	621.00
		100 - 160	0.5	234	7	4	0728 208	809.00
		160 - 290	0.5	234	7	4	0728 209	1070.00
		280 - 510	1.5	400	7	4	0728 210	2525.00

## 0728 Setting device for internal precision bore gauges



### Model

- Setting device for accurate adjustment of internal precision bore gauges to the required nominal dimension, with gauge blocks
- The setting jaws are made of carbide and are lapped to gauge block quality
- Setting device can be used in both, the vertical and horizontal measuring axis

### Delivery

- Wooden case
- Incl. stand (excludes gauge blocks)

⌘	📏	For measuring range	Error limit	Order no.	List price EUR
		mm	µm		
		4.5 - 160	2	0728 910	1473.00
		18 - 290	2	0728 915	1461.00
		160 - 510	2	0728 920	2114.00



### 0735 Crankshaft gauges



☒	☒	Measuring range mm	Reading mm	Order no.	List price EUR
		45 - 150	0.01	0735 101	460.00
		60 - 300	0.01	0735 102	415.00
		60 - 500	0.01	0735 103	482.00

### 0735 Replacement gauge for 0735



**Model**

- Without backplate

☒	☒	Order no.	List price EUR
<b>For measuring range 45 - 150 mm</b>			
		0735 901	254.00
<b>For measuring range 60 - 300 / 60 - 500 mm</b>			
		0735 902	211.00



## 0744 Universal comparator gauge UHRTAST





## 0744 Comparator gauge UHRTAST



### Model

- Comparator gauge for **external and internal measurements** for checking workpieces and setting of machines
- Versatile in use due to wide range of probes and inserts
- Measuring range up to 2000 mm by using optional extensions
- Without indicator
- The direction of the measuring force can be switched, the gauge can be used for external and internal measurements

- The adjustment can be conducted with a setting gauge, a combination of gauge blocks, setting ring or a micrometer
- The measuring range of the moveable measuring arm is 12 mm

### Delivery

- Wooden case
- Basic instrument without digital indicator, measuring arms and measuring probes (optional)
- Adapter 0744 189

### Accessories

Adapter accessories from 0744 to 0741  
 Adapter accessoried from 0741 to 0744

### Order no.

0744 188  
 0744 189

### List price EUR

89.00  
 89.00

	Measuring range		Measuring forces	Order no.	List price EUR
	mm	mm			
	0 - 200	25 - 250	external: ~5 N internal: ~5 N	0744 101	2099.00

## 0744 Pair of probe mounting block



\* for external measurement  
 \*\* for internal measurement

	Order no.	List price EUR
	0744 170*	289.00
	0744 171**	289.00

## 0744 Extensions



### Model

- Combinable with the basic instrument and further extensions by sticking together the pipe construction



0744 112



0744 114

	Length mm	Order no.	List price EUR
	100	0744 112	292.00
	200	0744 114	310.00
	400	0744 116	474.00



## 0744 Measuring inserts



0741 178

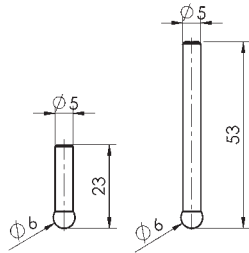

	Length mm	Diameter mm	Order no.	List price
				EUR
	23	6	0741 178	130.00
	53	6	0741 179	130.00

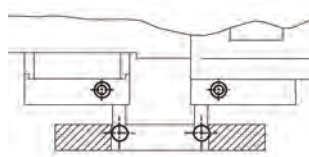

## 0744 Measuring inserts

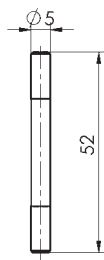

	Length mm	Diameter mm	Order no.	List price
				EUR
	52	5	0741 180	130.00

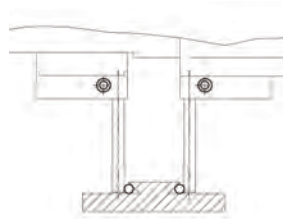

## 0744 Pair of offset measuring inserts

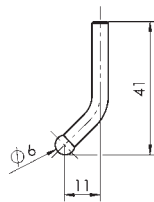

	Length mm	Diameter mm	Order no.	List price
				EUR
	41	6	0741 182	216.00

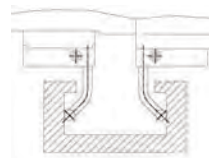



0744 Measuring inserts

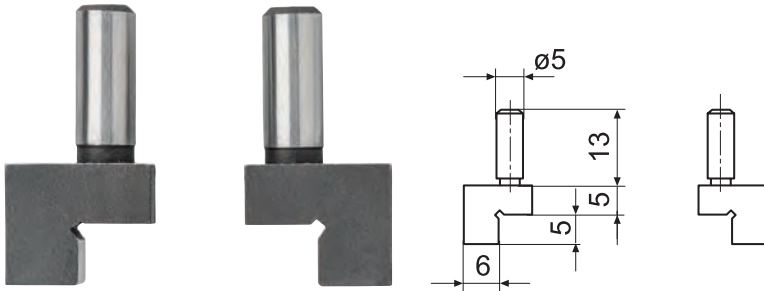

Model

- For measuring external central points

	Order no.	List price
	0744 172	EUR 351.00

0744 Pair of shoulder measuring inserts

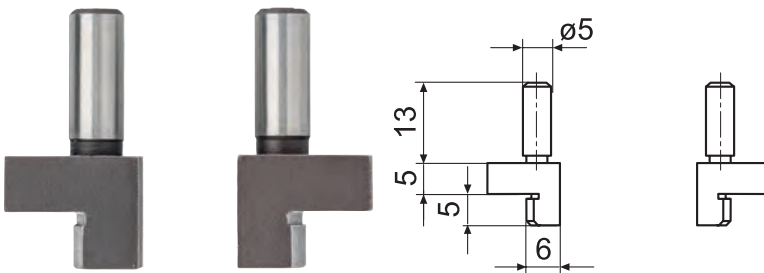

Model

- For measuring internal central points

	Order no.	List price
	0744 174	EUR 351.00

0744 Piece of measuring inserts with discs



	Length	Width	Diameter	Dimensions h	Order no.	List price
	mm	mm	mm	mm		EUR
	30	10	11	1	0744 175	111.50
	50	10	11	1	0744 176	111.50



## 0744 Pairs of measuring arms



### Model

- For mounting of adapter pieces and inserts with shaft-Ø 3.5 mm
- With lasered help rule (mm-divide) as position help for the depth stop pieces

▶▶	▶▶	Length mm	Order no.	List price EUR
		35	0744 122	326.00
		70	0744 124	348.00

## 0744 Pair of depth stop attachment for measuring arms

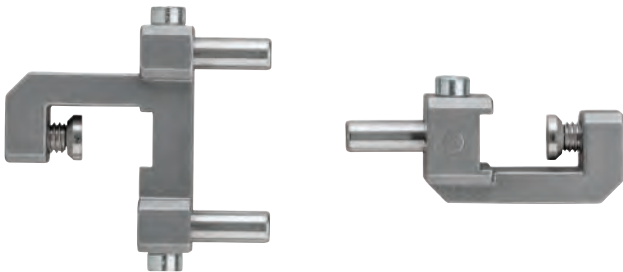

### Model

- Stops with anti-tilt 3-point support
- Hardened stop pins, exchangeable and movable

### Scope of delivery

- 1 pair of stop pieces with 3 stop pins Ø 5 x 20 mm
- additionally 1 stop pin each Ø 5 x 16 mm and Ø 5 x 10 mm for stop piece 1 point

▶▶	▶▶	Length mm	Width mm	Height mm	Order no.	List price EUR
		26	13	5	0744 136	297.00





## 0744 Pair of adapters 5 mm for measuring inserts M2.5



### Model

- All measuring inserts for dial gauges with M2.5 can be used (measuring inserts please refer to pages 108-111)

	Order no.	List price EUR
	0744 132	34.25

## 0744 Measuring insert plan (piece)



### Model

- With cylindrical mounting shank and snap ring for rotatable in the bore of the measuring arms 0744 122 / 124
- Made of hardened steel
- Mounting shank 3.5 mm

	Order no.	List price EUR
	0744 190	70.00

3

## 0744 Measuring insert spherical (piece)



### Model

- With cylindrical mounting shank and snap ring for rotatable in the bore of the measuring arms 0744 122 / 124
- Made of hardened steel
- Mounting shank 3.5 mm

	Order no.	List price EUR
	0744 192	70.00



## 0753 Universal indicator stands with magnetic base



0753 110



0753 120

### Model

- Chrome finished columns
- Base with V-groove
- Magnet with ON/OFF switch
- Mounting clamp: Ø 8 mm for indicators
- Integrated fine adjustment

### Delivery

- Cardboard box

✕	🏠	Projection	Column height	Column dia.	Arm dia.	Base dimensions	Magnetic force	Order no.	List price
		mm	mm	mm	mm	mm	N		EUR
		140	230	16	12	60 x 50 x 55	500	0753 110	28.10
		180	285	16	16	70 x 46 x 65	600	0753 120	69.00



## 0750 Universal indicator stands with magnetic base and combi clamp



0750 101

### Model

- Chrome plated columns
- Base with V-groove
- Magnet with ON/OFF switch
- **Combi clamp:** Ø 8 mm for dial gauges, swallow tail clamp for dial test indicators
- Intergrated fine adjustment

### Delivery

- Cardboard box

### Accessories

	Order no.	List price EUR
Replacement crosshead complete	0750 113	47.40
Wooden case for magnet - measuring support	0750 601	28.30

☒	☒	Projection mm	Column height mm	Column dia. mm	Arm dia. mm	Base dimensions mm	Magnetic force N	Order no.	List price EUR
<b>Crosshead clamp</b>									
		180	500	20	16	75 x 60 x 102	800	0750 102	211.00

## 0750 Pillar with transverse arm and fine adjustment



### Model

- Chrome plated column and transverse arm
- Mounting for indicator:
  - shank mounting Ø 8 mm for dial gauges
  - swallow tail clamp for dial test indicators
- Integrated fine adjustment

☒	☒	Thread	Projection mm	Column height mm	Column dia. mm	Arm dia. mm	Description	Order no.	List price EUR
		M12	180	500	20	16	for 0750 102	0750 122	109.00

## 0750 Magnetic base



0750 111

### Model

- Magnetic base with V-groove
- Cling to flat and cylindric parts
- Magnetic force can be switched On / Off by rotary switch

☒	☒	Thread	Base dimensions mm	Magnetic force N	Order no.	List price EUR
		M12	75 x 60 x 80	800	0750 112	123.00



## 0752 Magnetic indicator stands with central lock



0752 101



0752 103

### Model

- Column / Arm:
  - 0752 101 steel, chrome finished
  - 0752 103 aluminium, anodized
- Switch magnetic base with V-groove
- Central magnetic clamping system

- **Combi clamp:** Ø 8 mm for dial gauges, swallow tail clamp for dial test indicators
- Intergrated fine adjustment

### Delivery

- Cardboard box

▶	▶	Projection mm	Column height mm	Column dia. mm	Base dimensions mm	Magnetic force N	Order no.	List price EUR
		260	310	10	70 x 46 x 65	600	0752 101	163.00
		320	370	18	70 x 46 x 65	600	0752 103	208.00



## 0754 Universal magnetic holder



### Model

- Magnetic base with V-groove
- With mounting hole Ø 8 mm
- Three-sided magnet

### Delivery

- Cardboard box

	Max. height mm	Base dimensions mm	Magnetic force N	Order no.	List price EUR
	57	70 x 35	260	0754 101	112.00

3

## 0756 Universal magnetic holder



### Model

- Cast iron base with two magnets on the bottom of the holder
- With mounting hole Ø 8 mm

### Delivery

- Cardboard box

	Max. height mm	Base dimensions mm	Magnetic force N	Order no.	List price EUR
	45	72 x 37	180	0756 101	67.00



## 0770 Compact measuring stands



0770 102



0770 103



0770 201

### Model

- Cast base
- Chrome finished columns
- Hardened steel table
- With dust grooves (Order No. 0770 102 non-stop plane)
- With mounting hole for dial gauges  $\varnothing$  8 mm

### Delivery

- Cardboard box

Marked *	Marked *	Measuring height mm	Projection mm	Size of table mm	Column dia. mm	Arm dia. mm	Order no.	List price EUR
<b>With fixed arm</b>								
		100	49	$\varnothing$ 50	22	-	0770 102	235.00
		100	49	60 x 68	22	-	0770 103	272.00
<b>With adjustable transverse arm</b>								
		100	100	60 x 68	22	18	0770 201	300.00
		150	135	98 x 115	28	20	0770 205	425.00



## 0772 Measuring stand



### Model

- Cast base
- Hardened steel table
- With dust grooves
- With a threaded column and an adjustable transverse arm
- With mounting hole for dial gauges Ø 8 mm

### Delivery

- Cardboard box

☒	☒	Measuring height	Projection	Size of table	Column dia.	Arm dia.	Order no.	List price
		mm	mm	mm	mm	mm		EUR
		160	200	170 x 215	35	22	0772 024	856.00

3

## 0785 Precision measuring stands



### Model

- Base made of hard stone
- Base plate accuracy according to DIN 876-00
- With a threaded column
- With adjustable transverse arm
- With mounting hole for dial gauges Ø 8 mm
- Vertical adjustment by threaded spindle with setting ring

### Delivery

- Cardboard box

☒	☒	Measuring height	Projection	Size of table	Column dia.	Arm dia.	Order no.	List price
		mm	mm	mm	mm	mm		EUR
		200	200	150 x 260	35	22	0785 108	721.00
	▪	220	220	300 x 350	35	22	0785 109	1764.00



## 0763 Universal measuring support



### Model

- Column and transverse arm chrome plated
- Column is moving and can be clamped in the T-groove
- Heavy base plate with prismatic base and T-groove
- Mounting for display devices:
  - support for indicators with shaft  $\varnothing$  8 mm, swallow tail clamp for dial test indicators
- Integrated fine adjustment

### Delivery

- Cardboard box

	Projection	Column height	Column dia.	Arm dia.	Base dimensions	Order no.	List price
	mm	mm	mm	mm	mm		EUR
	180	300	16	16	250 x 60 x 35	0763 100	315.00





## 0780 Bench centres

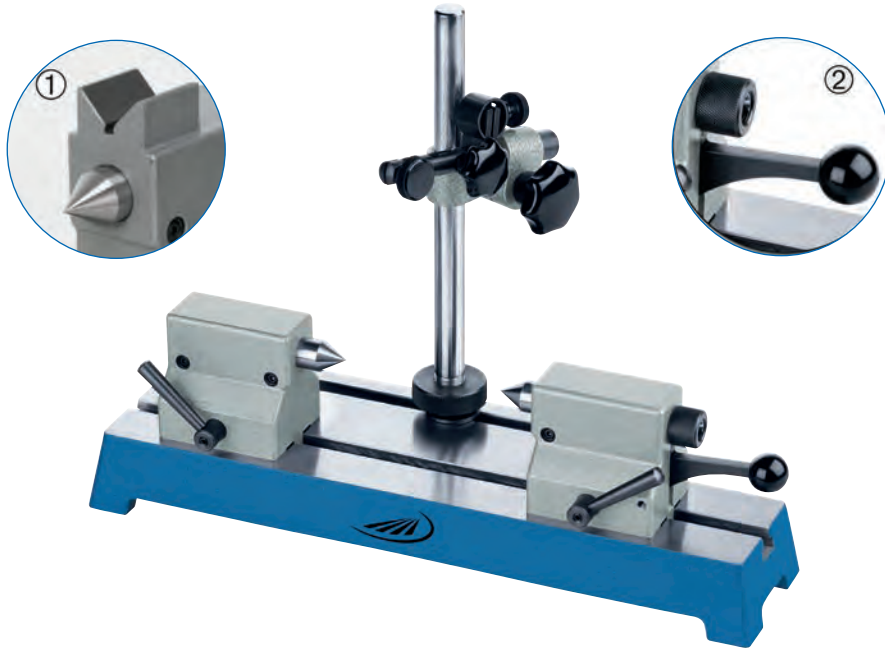

### Model

- Finely ground surface, flatness tolerance according to DIN 876-2
- With two adjustable tailstocks
- Left tailstock with fixed centre
- Right tailstock with retractable spring mounted centre, free lift appr. 10 mm

### Delivery

- Tailstocks can be clamped via an eccentric clamp
- Tailstock height 75 mm with integrated V-groove support
- Quick-clamping device by clamping lever
- With T-groove and support column
- With mounting hole for dial gauges  $\varnothing$  8 mm

- Cardboard box

▶	☒	Height of centers	Workpiece load	Distance between centres	Center dia.	T-groove width	Base	Order no.	List price
		mm	p. tailstock max. kg	mm	mm	mm	mm		EUR
		50	5	200	16	10H7	350 x 110	0780 101	682.00
		50	5	350	16	10H7	500 x 110	0780 102	866.00
		75	5	200	16	10H7	350 x 110	0780 104*	780.00
		75	5	350	16	10H7	500 x 110	0780 105*	889.00
	▪	100	20	450	22	12H7	700 x 180	0780 107	2236.00
	▪	150	20	450	22	12H7	700 x 180	0780 108	2493.00

\* With integrated V-groove support on the tailstocks for  $\varnothing$  6 - 24 mm

### Accessories

	Order no.	List price EUR
Replacement centre, retractable, $\varnothing$ 16 mm (50 - 75 mm)	0780 174	56.00
Replacement centre, fixed, $\varnothing$ 16 mm (50 - 75 mm)	0780 175	44.00
Replacement centre, retractable, $\varnothing$ 22 mm (100 - 150 mm)	0780 177	141.00
Replacement centre, fixed, $\varnothing$ 22 mm (100 - 150 mm)	0780 178	130.00



## 0780 Bench centres with roller supports



### Specification

- Finely ground surface, flatness tolerance according to DIN 876-2
- With two roller supports
- Concentricity tolerance of the rolls 0.005 mm
- Quick-clamping device by clamping lever
- With T-groove and support column
- With mounting hole for dial gauges  $\varnothing$  8 mm
- Fine adjustment

### Delivery

- Cardboard box

	Height of roller supports mm	T-groove width mm	Base mm	Contact surface mm	Order no.	List price EUR
	65	10H7	350 x 110	3 - 30	0780 201	630.00
	65	10H7	500 x 110	3 - 30	0780 202	788.00
	100	12H7	700 x 180	4 - 60	0780 206	1578.00



## 0780 Bench centres with V-groove supports



### Specification

- Finely ground surface, flatness tolerance according to DIN 876-2
- With two V-supports
- Quick-clamping device by clamping lever
- Prismatic contact surface 90°
- V-groove surfaces made of hardened steel (replaceable)
- With T-groove and support column
- With mounting hole for dial gauges Ø 8 mm
- Fine adjustment

### Delivery

- Cardboard box

Icon	Height of V-supports mm	T-groove width mm	Base mm	Contact surface mm	Order no.	List price EUR
☒	65	10H7	350 x 110	5 - 25	0780 301	597.00
☒	65	10H7	500 x 110	5 - 25	0780 302	754.00
☒	100	10H7	700 x 180	5 - 50	0780 306	1511.00



## 0780 Pair of v-support inserts



### Model

- V-support inserts to place in and for testing of shafts without centrebores
- V-support inserts are exchanged for the pointed alignment centre of the tailstocks

✕	☒	For height of centers	Max. workpiece dia.	Contact surface	Order no.	List price
		mm	mm	mm		EUR
		50/75	15	3 - 15	0780 021	123.00
		100	45	8 - 45	0780 023	157.00

## 0780 Replacement support column



### Model

- Column is moving and can be clamped in the T-groove
- Mounting for indicator:
  - shaft mounting  $\varnothing$  8 mm for dial test indicators
- Integrated fine adjustment

✕	☒	For height of centers	Projection	T-groove width	Column height	Column dia.	Arm dia.	Order no.	List price
		mm	mm	mm	mm	mm	mm		EUR
		50/75	105	10	200	18	14	0780 072	146.00
		100	105	12	240	18	14	0780 073	265.00
		150	105	12	440	18	14	0780 074	292.00



## Pair of replacement tailstocks for 0780

### Model

- Included in base model 0780
- 75 mm with intergrated V-groove support
- For heavy workpieces with load up to 40 kg on request

Height of centers mm	Workpiece load p. tailstock max. kg	T-groove width mm	Order no.	List price EUR
50	5	10	0780 091	429.00
75	5	10	0780 092	482.00
100	20	12	0780 093	991.00
150	20	12	0780 094	1025.00

## Pair of V-groove supports for 0780



### Model

- For workpieces without centering
- Functional test through applying on e.g. plain lateral surface
- Recognition of form errors
- For exchange of centre supports
- Prismatic contact surface 90°
- V-groove surfaces made of hardened steel (replaceable)
- T-grooves bearing
- Eccentric clamp

Height of centres* mm	Height of V-supports mm	T-groove width mm	Contact surface mm	Order no.	List price EUR
65	65	10	5 - 25	0780 032	225.00
100	100	12	5 - 50	0780 033	310.00

\* based on the center of an axis of a shaft Ø 10 mm

## Pair of roller supports for 0780



### Model

- For exchange of centre supports
- Ball bearing rollers for easy turning of the workpieces
- Concentricity tolerance 0.005 mm

Height of roller supports* mm	T-groove width mm	Contact surface mm	Order no.	List price EUR
65	10	3 - 30	0780 042	218.00
100	12	4 - 60	0780 043	295.00

\* based on the center of an axis of a shaft Ø 10 mm



## 0783 Bench centre



DIN  
876-1



### Model

- Dark granite work bench
- Flatness tolerance in accordance to DIN 876-1
- Right tailstock with retractable spring mounted centre (quick adjustment lever)
- Left tailstock with fixed centre
- Tailstocks can be adjusted via an eccentric clamp

### Delivery

- Carton
- Included:
  - Work bench
  - Support post
  - 1 pair of tailstocks with pointed alignment centre 60° MK 2

☒	☒	Height of centers mm	Workpiece load p. tailstock max. kg	Distance between centres mm	T-groove width mm	Base mm	Order no.	List price EUR
▪		200	24	650	14	1100 x 180	0783 012	3996.00

Accessories	Order no.	List price EUR
Pair of pointed alignment centres	0782 181	254.00
Tailstock	0782 191	1321.00
Measuring support	0783 070	334.00

## 0782 Pair of roller supports



### Model

- For exchange of centre supports
- Ball bearing rollers for easy turning of the workpieces
- T-grooves bearing
- Eccentric clamp

☒	☒	Height of roller supports mm	T-groove width mm	Contact surface mm	Order no.	List price EUR
		200	14	25 - 100	0782 160	796.00



## 0784 Concentricity measuring gauge with disc supports

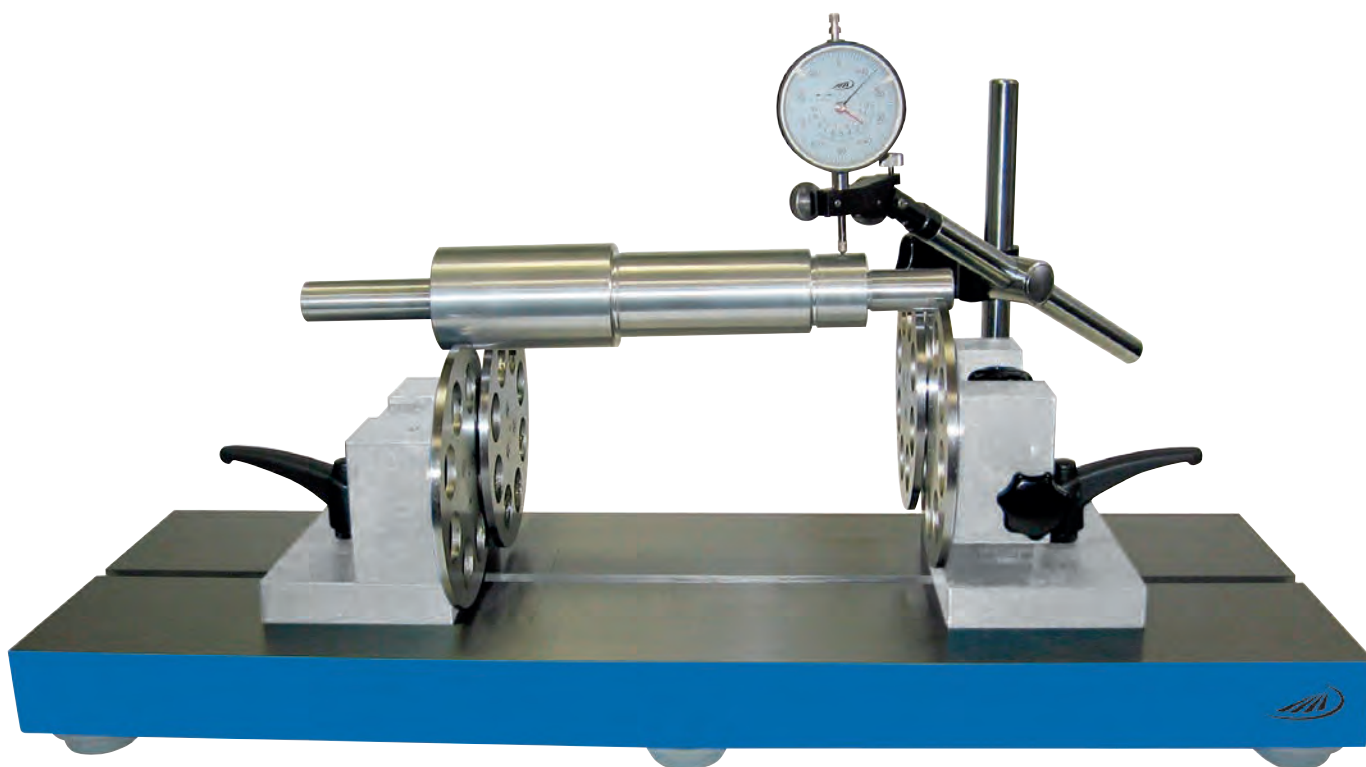

3

### Model

- Centerless concentricity measuring instrument
- High accuracy discs are being mounted on bearings; free of play
- Discs can be slid to either side on the base

### Delivery

- One sliding disc can be adjusted up to 30 mm for diametral compensation
- Concentricity accuracy <math>< 5 \mu\text{m}</math>
- Carton
- Includes the support stand, excludes a dial gauge

Icon	Workpiece load p. tailstock max. kg	Distance between the end mm	Disc diameter mm	Max. workpiece dia. mm	Order no.	List price EUR
▪	25	400	120	250	0784 108	3495.00

### Accessories

Accessories	Order no.	List price EUR
Replacement discs, pair, Ø 120 mm	0784 181	705.00
Complete support stand for order no. 0784 108	0784 190	198.00



## 0788 Shaft measuring instrument



### Model

- For rapid measurement of diameters, distances, shoulders, taper, roundness, etc.
- For vertical and horizontal alignment
- Vertical base with 3 hardened adjustment support surfaces
- Measuring beam is made of stainless steel
- Load capacity horizontal max. 20 kg

### Delivery

- Cardboard box
- Without measuring support, guideway, dial gauge (optional accessories)



application as a bench centre

✕	📏	Height of centres	Distance between centres	T-groove width	Base	Order no.	List price
		mm	mm	mm	mm		EUR
▪		75	550	10 H7	200 x 120	0788 104	1275.00
<b>Accessories</b>						<b>Order no.</b>	<b>List price</b>
Support arm with guideways						0788 180	259.00



0788 180





## 0788 Shaft measuring instrument lightweight



### Model

- For rapid measurement of distances, shoulders, taper, roundness, etc.
- Vertical and horizontal alignment
- Vertical base with 3 hardened adjustment support surfaces
- Measuring beam is made of hard anodized aluminium profile
- Aluminium tailstocks
- Load capacity horizontal max. 15 kg

### Delivery

- Cardboard box
- Without measuring support, guideway, dial gauge (optional accessories)



application as a bench centre

3

	Height of centers	Distance between the end	T-groove width	Base	Order no.	List price	
	mm	mm	mm	mm		EUR	
	75	550	10 H7	200 x 150	0788 904	1015.00	
<b>Accessories</b>						<b>Order no.</b>	<b>List price</b>
						<b>EUR</b>	
Support arm with holder					0788 980	83.00	
Support arm with guideways					0788 990	368.00	



0788 980



0788 990



# SAMPLES MARKING GAUGES

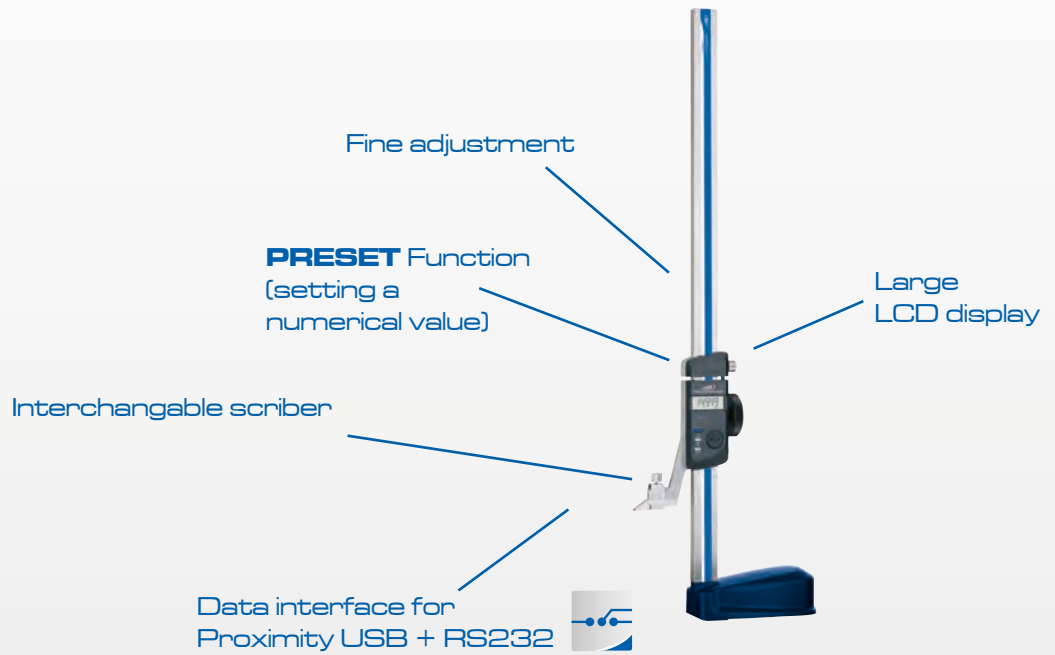
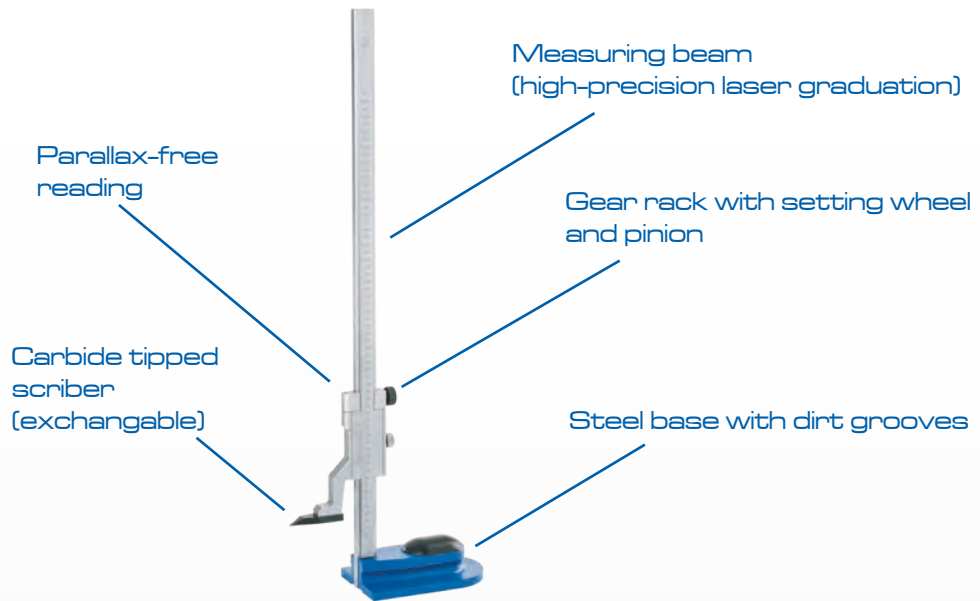

More products from our range of **Marking gauges**



MARKING **GAUGES**



**DIVIDERS**



MARKING **CALIPERS**

## 4. CHAPTER MARKING GAUGES

140	Scribers
141	Dividers
142	Internal and external calipers
146	Marking calipers / Marking gauges
148	Height and scribing gauges

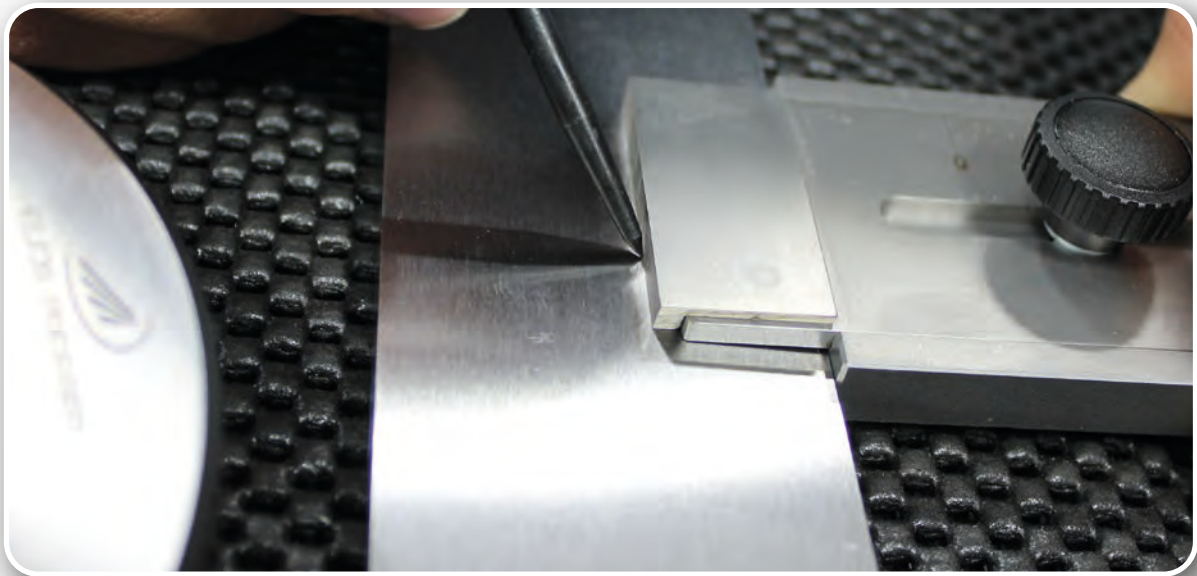



## 0300 Scribes



		Length mm	Material	Order no.	List price EUR
<b>With straight screw-in scribe</b>					
		175	Chromium-vanadium steel, hardened	0300 007	2.40
<b>With one straight and one L-shaped screw-in scribe</b>					
		250	Chromium-vanadium steel, hardened	0300 008	2.60
<b>With one straight and one angled screw-in and burnished scribe</b>					
		200	Chromium-vanadium steel, hardened	0300 011	2.40
		250	Carbide-tipped	0300 114	10.00
<b>With a mechanic and pocket clip</b>					
		150	Carbide-tipped	0300 120	14.50
<b>One piece hexagonal body with a pocket clip</b>					
		180	Carbide-tipped	0300 102	6.40
<b>For scribe 0300 008, with straight scribe, plastic handle</b>					
		110	Carbide-tipped	0300 112	5.30

## 0300 Replacement scribes



		Length mm	Material	Order no.	List price EUR
<b>For scribe 0300 120</b>					
		33	Carbide-tipped	0300 130	3.90



0301 Precision dividers



Model

- With a rivetted hinge
- Hardened needle, shaped ground points
- Special steel

Delivery

- Cardboard box

✂	📏	Length mm	Order no.	List price EUR
		150	0301 001	8.30
		175	0301 002	9.40
		200	0301 003	10.40
		250	0301 004	14.50
		300	0301 005	17.50
		400	0301 006	47.30
		500	0301 007	67.00

4

0302 / 0306 Dividers with quadrant



Model

- With a rivetted hinge
- Special steel
- Quadrant with robust, milled locking screw
- Hardened points

Delivery

- Cardboard box

✂	📏	Length mm	Order no.	List price EUR
		150	0302 001	12.10
		175	0302 002	13.30
		200	0302 003	14.30
		250	0302 004	18.60
		300	0302 005	24.40
		400	0302 006	68.00
		500	0302 007	84.00
<b>With pencil holder</b>				
		150	0306 001	15.50
		200	0306 003	17.50
		300	0306 005	27.30



## 0303 Precision internal calipers





### Model

- With a rivetted hinge
- Special steel
- Hardened measuring points

### Delivery

- Cardboard box

 	Length mm	Order no.	List price EUR
	150	0303 001	8.10
	200	0303 003	10.00
	250	0303 004	10.60
	300	0303 005	12.10
	400	0303 006	14.80
	500	0303 007	18.40

## 0304 Precision external calipers





### Model

- With a rivetted hinge
- Special steel
- Hardened measuring points

### Delivery

- Cardboard box

 	Length mm	Order no.	List price EUR
	150	0304 001	8.10
	200	0304 003	10.00
	250	0304 004	10.60
	300	0304 005	12.10
	400	0304 006	14.80
	500	0304 007	18.40
	600	0304 008	27.80
	800	0304 009	39.90
	1000	0304 010	74.00



## 0310 Spring dividers



### Model

- Quick release set screw
- Special steel
- Fixed points
- Hardened points
- Quick release set screw and spring are burnished

### Delivery

- Cardboard box

☒	☒	Radius mm	Order no.	List price EUR
		115	0310 102	4.60
		140	0310 103	5.00
		190	0310 105	5.60
		240	0310 107	7.20
		290	0310 108	8.40

## 0311 Spring dividers



### Model

- Quick release set screw
- Special steel
- Interchangeable points
- Hardened points
- Quick release set screw and spring are burnished

### Delivery

- Cardboard box

☒	☒	Radius mm	Order no.	List price EUR
		90	0311 101	4.90
		115	0311 102	5.70
		140	0311 103	6.70
		190	0311 105	7.90
		240	0311 107	9.60
		290	0311 108	10.30

## 0311 Pair of replacement points for spring dividers



☒	☒	Material	Order no.	List price EUR
		Special steel, hardened	0311 120	2.60
		Carbide-tipped	0311 121	21.60



## 0312 Spring internal calipers



### Model

- Internal caliper with quick release set screw
- Special steel
- Quick release set screw and spring are burnished

### Delivery

- Cardboard box

▶▶	🏠	Length mm	Order no.	List price EUR
		100	0312 101	3.90
		150	0312 103	5.60
		200	0312 105	6.70
		250	0312 107	8.30
		300	0312 108	10.00

## 0313 Spring external calipers



### Model

- External caliper with quick release set screw
- Special steel
- Quick release set screw and spring are burnished

### Delivery

- Cardboard box

▶▶	🏠	Length mm	Order no.	List price EUR
		100	0313 101	3.90
		150	0313 103	5.60
		200	0313 105	6.70
		250	0313 107	8.30
		300	0313 108	10.00







## 0308 Combined internal / external calipers



### Model

- Internal and external caliper
- Stainless steel
- Satin chrome finished scale
- With a rivetted hinge
- mm graduation for internal and external measurement

### Delivery

- Cardboard box

☒	☒	Length mm	Measuring range mm	Order no.	List price EUR
		190	0 - 120	0308 201	106.00
		250	0 - 160	0308 202	128.00
		310	0 - 200	0308 303	156.00
		460	0 - 300	0308 305	184.00

## 0322 Marking gauges with guide roll



### Model

- Stainless steel, hardened
- Reading parts are satin chrome finished
- Guide roll
- Locking screw
- Interchangeable scriber made of hardened steel
- Factory standard

### Delivery

- Imitation leather case

☒	☒	Measuring range mm	Reading mm	Order no.	List price EUR
		0 - 200	0.1	0322 501	29.20
		0 - 400	0.1	0322 503	45.80

### Accessories

	Order no.	List price EUR
Replacement scribers ø 2 mm	0322 510	5.20



## 0344 Marking calipers

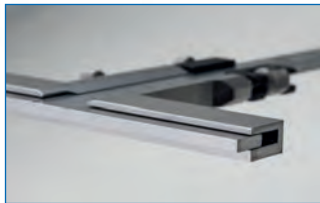
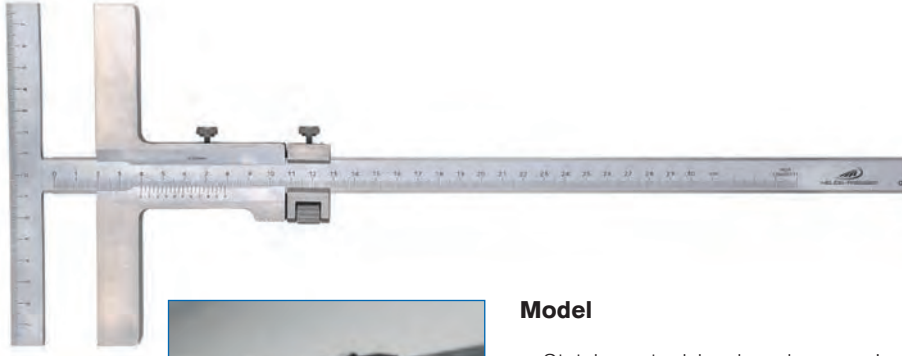

### Model

- Stainless steel, hardened
- Long T-shaped marking edge
- Factory standard
- Reading parts are satin chrome finished
- Low set master scale
- Fine adjustment
- Locking screw

### Delivery

- Plastic case

▶◀	🏠	Measuring range	Reading	Rail cross-section	Length of edge	Order no.	List price
		mm	mm	mm	mm		EUR
		0 - 180	0.05	17 x 3,5	135	0344 501	147.00
		0 - 250	0.05	17 x 3,5	135	0344 502	188.00
		0 - 300	0.05	17 x 3,5	160	0344 503	237.00



## 0321 Marking gauges

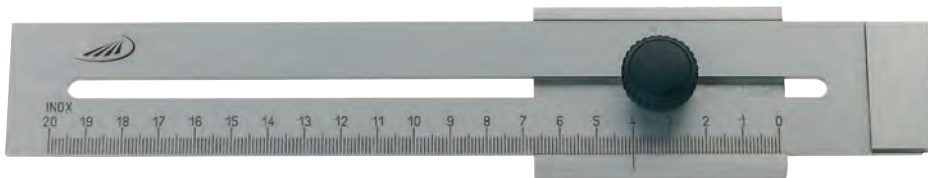

### Model

- Flat, stable construction
- Stainless steel, chrome finished
- Locking screw
- Hardened stop face
- mm graduated scale
- Factory standard

### Delivery

- Cardboard box

☒ ☒	Measuring range mm	Reading mm	Rail cross-section mm	Order no.	List price EUR
	0 - 200	0.1	40	0321 301	25.60
	0 - 250	0.1	40	0321 302	28.70
	0 - 300	0.1	40	0321 303	29.20
	0 - 500	0.1	40	0321 305	56.00

## 0323 Marking gauges



### Model

- Stainless steel
- Locking screw
- For marking by scale as well as for marking of 45° - or 90° - mitres
- mm graduation
- Factory standard

### Delivery

- Cardboard box

☒ ☒	Measuring range mm	Reading mm	Rail cross-section mm	Order no.	List price EUR
	100	1	40	0323 308	19.10
	200	1	40	0323 318	24.40



## 0345 Analogue height and scribing gauges



0345 530

### Model

- Measuring beam is made from stainless steel
- Vernier and scale are satin chrome finished
- Parallax-free reading
- Setting screw
- Fine adjustment
- Steel base with dirt grooves
- Scribing possible from base plate level
- Factory standard

### Delivery

- With exchangeable scriber, carbide tipped, 75 mm

☒	☒	Measuring range mm	Reading mm	Base dimensions mm	Rail cross-section mm	Order no.	List price EUR
<b>With fine adjustment</b>							
		0 - 300	0.02	145 x 90 x 44	30 x 12	0345 522	439.00
		0 - 600	0.02	165 x 110 x 44	30 x 12	0345 530	549.00

## 0345 Replacement scribers for 0345



### Model

- Carbide tipped
- Packing: individually packed

☒	☒	Length mm	Material	Order no.	List price EUR
		75	Carbide-tipped	0345 910	140.00
		150	Carbide-tipped	0345 912	156.00



## 0350 Digital height and scribing gauges



### Model

- Slider and rail stainless and hardened
- LCD display 12 mm
- Handwheel for positioning and measuring
- Steel base
- Fine adjustment and toothed rack
- Factory standard

### Functions



- ON / OFF
- Zeroing at any position
- mm / inch changeover
- PRESET function (presetting of measured value)
- ABS (display can be set to be set to zero without losing the reference to the preset)
- Data output USB + RS232 and Digimatic

### Delivery

- With interchangeable scribing jaws, carbide tipped, 65 mm

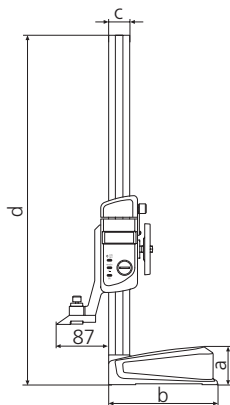

	Measuring range mm	Reading mm	Order no.	List price EUR
<b>mit Feineinstellung</b>				
	0 - 350	0,01	0350 722	634.00
	0 - 600	0,01	0350 730	792.00
	0 - 980	0,01	0350 734	1097.00

Order no.	a mm	b mm	c mm	d mm
0350 722	62	180	35	580
0350 730	62	180	35	835
0350 734	66	220	35	1230

## 0350 Replacement scribers for 0350



### Model

- Carton: individually packed

	Length mm	Material	Order no.	List price EUR
	75	Carbide-tipped	0350 910	88.50



## 0349 DIGI-MET® Height gauges with sliding scriber



0349 722\*

### Model

- Measuring beam and slide is made from stainless steel and is hardened
- LCD-display 12 mm
- Handwheel for positioning and measuring
- Fine adjustment and rack
- Setting screw
- Steel base with dirt grooves
- Scribing possible from base plate level

### Functions

- ON / OFF
- Set to zero at any point
- mm / inch switching
- PRESET-Function (setting a numerical value)
- Hold
- ABS (display can be set to zero without losing the Preset value)
- Reversal of counting direction
- Factor input
- Data output Proximity USB + RS232

### Delivery

- With **straight** scriber

Range revision!  
Information about the  
successor model on request  
as soon as available

▶◀	Measuring range		Reading		Base dimensions mm	Beam mm	Order no.	List price EUR
	mm	inch	mm	inch				
	0 - 350	0 - 14	0.01	.0005	180 x 98 x 50	35 x 12	0352 722	840.00
	0 - 600	0 - 24	0.01	.0005	180 x 98 x 50	35 x 12	0352 730	970.00
	0 - 980	0 - 39	0.01	.0005	220 x 120 x 50	35 x 12	0352 734	1190.00

### Accessories

Data cable Proximity to USB

### List price

1998 760

### EUR

166.00

\*Figure does not show standard delivery content



## 0349 Replacement scribers for 0352



		Length mm	Material	Order no.	List price EUR
<b>Cranked scriber, for marking operations from base</b>					
		270	Special steel, hardened	0349 912	150.00
		270	Carbide-tipped	0349 916	191.00
<b>Straight scriber</b>					
		270	Special steel, hardened	0349 910	129.00
		270	Carbide-tipped	0349 914	167.00

Limited measuring range while using a cranked scriber

## 0331 Replacement scriber for height gauges not any longer included in our catalogue



Order no. Scriber	Order no. Height gauge						Material	Length mm	Shaft mm	List price EUR
	0330...	0331...	0336...	0338...	0340...	0342...				
0334 101	•		•		•	•	straight, carbide tipped	65	8 x 8	85.00
0334 102	•		•		•	•	straight, carbide tipped	75	-	140.00



# SAMPLES SQUARES

SQUARE **WITH BASE**

SQUARE **WITHOUT BASE**



HIGH **QUALITY**

MADE IN **GERMANY**

Manufactured according to **DIN 875**

**Highest** precision:  
Accuracy **grade 0**

Blade length up to **2 meters**  
(Accuracy grade 2)

Made from **special** or **stainless** steel

More **highlights** from our range of **squares**



**ACUTE ANGLE**  
SQUARES



**MITRE SQUARES**



**BEVEL**  
**PROTRACTORS**



## 5. CHAPTER SQUARES, PROTRACTORS AND BEVEL PROTRACTORS

154	Squares with / without base
158	Steel squares
159	Squares with hard and slim blade
161	Knife edge squares
162	Inspection set
163	Centre squares / Flange squares
164	Mitre / Acute angle squares
166	Squares for specific measuring tasks and target groups
168	Wooden cases
169	Protractors
172	Universal bevel protractors

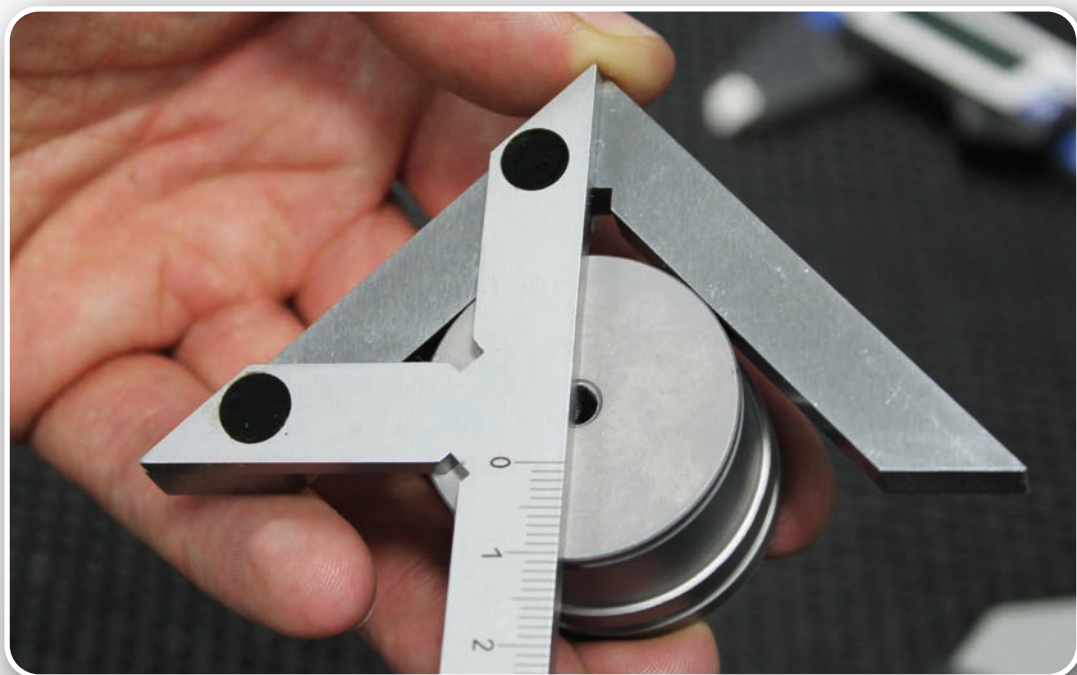



## 0368 Squares with base accuracy grade 0



### Model

- DIN 875
- Accuracy grade 0
- For exact angle testing (for example: tool making)

### Delivery

- Cardboard box
- From blade length 1000 mm in a transportation box

		Jaw length mm	Cross-section mm	Order no.	List price EUR	DIN 875
<b>Special steel</b>						
		75 x 50	15 x 5	0368 102	28.50	
		100 x 70	20 x 5	0368 103	31.80	
		150 x 100	25 x 5	0368 104	42.70	
		200 x 130	30 x 6	0368 105	55.00	
		250 x 165	35 x 7	0368 106	73.00	
		300 x 200	40 x 8	0368 107	90.00	
		400 x 265	45 x 10	0368 108	195.00	
		500 x 330	50 x 10	0368 109	287.00	
		600 x 400	50 x 10	0368 110	405.00	
		750 x 500	60 x 12	0368 111	810.00	
	▪	1000 x 660	70 x 15	0368 112	1362.00	
<b>Stainless steel</b>						
		75 x 50	15 x 5	0368 202	55.00	
		100 x 70	20 x 5	0368 203	65.00	
		150 x 100	25 x 5	0368 204	88.00	
		200 x 130	30 x 6	0368 205	119.00	
		250 x 165	35 x 7	0368 206	166.00	
		300 x 200	40 x 8	0368 207	214.00	
		400 x 265	45 x 10	0368 208	331.00	
		500 x 330	50 x 10	0368 209	457.00	
		600 x 400	50 x 10	0368 210	679.00	
		750 x 500	60 x 12	0368 211	1166.00	
	▪	1000 x 660	70 x 15	0368 212	2472.00	

## 0369 Squares without base accuracy grade 0



### Model

- DIN 875
- Accuracy grade 0
- For exact angle testing (for example: tool making)

### Delivery

- Cardboard box
- From blade length 1000 mm in a transportation box

		Jaw length mm	Cross-section mm	Order no.	List price EUR	DIN 875
<b>Special steel</b>						
		75 x 50	15 x 5	0369 102	19.80	
		100 x 70	20 x 5	0369 103	21.40	
		150 x 100	25 x 5	0369 104	26.10	
		200 x 130	30 x 6	0369 105	36.10	
		250 x 165	35 x 7	0369 106	48.80	
		300 x 200	40 x 8	0369 107	68.00	
		400 x 265	45 x 10	0369 108	137.00	
		500 x 330	50 x 10	0369 109	179.00	
		600 x 400	50 x 10	0369 110	286.00	
		750 x 500	60 x 12	0369 111	530.00	
	▪	1000 x 660	70 x 15	0369 112	945.00	
<b>Stainless steel</b>						
		75 x 50	15 x 5	0369 202	36.60	
		100 x 70	20 x 5	0369 203	44.30	
		150 x 100	25 x 5	0369 204	55.00	
		200 x 130	30 x 6	0369 205	84.00	
		250 x 165	35 x 7	0369 206	110.00	
		300 x 200	40 x 8	0369 207	135.00	
		400 x 265	45 x 10	0369 208	228.00	
		500 x 330	50 x 10	0369 209	318.00	
		600 x 400	50 x 10	0369 210	534.00	
		750 x 500	60 x 12	0369 211	995.00	
	▪	1000 x 660	70 x 15	0369 212	1866.00	



## 0385 Inspection squares with base accuracy grade 0, hardened



### Model

- DIN 875
- Accuracy grade 0
- For exact angle testing (for example: tool making)

### Delivery

- Cardboard box

**DIN  
875**

	Jaw length mm	Cross-section mm	Order no.	List price EUR
<b>Special steel</b>				
	50 x 40	15 x 4	0385 102	28.60
	75 x 50	15 x 4	0385 103	30.50
	100 x 70	20 x 5	0385 104	36.50
	150 x 100	25 x 6	0385 105	55.00
	200 x 130	30 x 7	0385 106	76.00
	300 x 200	40 x 8	0385 108	132.00
<b>Stainless steel</b>				
	50 x 40	15 x 4	0385 202	39.60
	75 x 50	15 x 4	0385 203	44.00
	100 x 70	20 x 5	0385 204	55.00
	150 x 100	25 x 6	0385 205	73.00
	200 x 130	30 x 7	0385 206	93.00
	300 x 200	40 x 8	0385 208	137.00

## 0386 Inspection squares without base accuracy grade 0, hardened



### Model

- DIN 875
- Accuracy grade 0
- For exact angle testing (for example: tool making)

### Delivery

- Cardboard box

**DIN  
875**

**5**

	Jaw length mm	Cross-section mm	Order no.	List price EUR
<b>Special steel</b>				
	50 x 40	15 x 4	0386 102	21.60
	75 x 50	15 x 4	0386 103	23.20
	100 x 70	20 x 5	0386 104	28.30
	150 x 100	25 x 6	0386 105	35.10
	200 x 130	30 x 7	0386 106	45.20
	300 x 200	40 x 8	0386 108	87.00
<b>Stainless steel</b>				
	50 x 40	15 x 4	0386 202	27.30
	75 x 50	15 x 4	0386 203	30.90
	100 x 70	20 x 5	0386 204	36.50
	150 x 100	25 x 6	0386 205	47.30
	200 x 130	30 x 7	0386 206	61.00
	300 x 200	40 x 8	0386 208	121.00



## 0370 Squares with base accuracy grade 1



### Model

- DIN 875
- Accuracy grade 1
- For angle testing in production and factory

### Delivery

- Cardboard box
- From blade length 1000 mm in a transportation box

		Jaw length mm	Cross-section mm	Order no.	List price EUR
<b>Special steel</b>					
		75 x 50	15 x 5	0370 102	17.60
		100 x 70	20 x 5	0370 103	19.80
		150 x 100	25 x 5	0370 104	26.50
		200 x 130	30 x 6	0370 105	33.70
		250 x 165	35 x 7	0370 106	45.10
		300 x 200	40 x 8	0370 107	57.00
		400 x 265	45 x 10	0370 108	112.00
		500 x 330	50 x 10	0370 109	164.00
		600 x 400	50 x 10	0370 110	232.00
		750 x 500	60 x 12	0370 111	463.00
	▪	1000 x 660	70 x 15	0370 112	778.00
<b>Stainless steel</b>					
		75 x 50	15 x 5	0370 202	19.40
		100 x 70	20 x 5	0370 203	21.70
		150 x 100	25 x 5	0370 204	32.70
		200 x 130	30 x 6	0370 205	42.90
		250 x 165	35 x 7	0370 206	59.00
		300 x 200	40 x 8	0370 207	78.00
		400 x 265	45 x 10	0370 208	198.00
		500 x 330	50 x 10	0370 209	254.00
		600 x 400	50 x 10	0370 210	395.00
		750 x 500	60 x 12	0370 211	611.00
	▪	1000 x 660	70 x 15	0370 212	988.00

**DIN  
875**

## 0371 Squares without base accuracy grade 1



### Model

- DIN 875
- Accuracy grade 1
- For angle testing in production and factory

### Delivery

- Cardboard box
- From blade length 1000 mm in a transportation box

		Jaw length mm	Cross-section mm	Order no.	List price EUR
<b>Special steel</b>					
		75 x 50	15 x 5	0371 102	12.60
		100 x 70	20 x 5	0371 103	13.90
		150 x 100	25 x 5	0371 104	17.00
		200 x 130	30 x 6	0371 105	21.90
		250 x 165	35 x 7	0371 106	30.50
		300 x 200	40 x 8	0371 107	38.90
		400 x 265	45 x 10	0371 108	93.00
		500 x 330	50 x 10	0371 109	121.00
		600 x 400	50 x 10	0371 110	168.00
		750 x 500	60 x 12	0371 111	316.00
	▪	1000 x 660	70 x 15	0371 112	541.00
<b>Stainless steel</b>					
		75 x 50	15 x 5	0371 202	13.80
		100 x 70	20 x 5	0371 203	15.30
		150 x 100	25 x 5	0371 204	18.60
		200 x 130	30 x 6	0371 205	27.90
		250 x 165	35 x 7	0371 206	37.80
		300 x 200	40 x 8	0371 207	47.40
		400 x 265	45 x 10	0371 208	156.00
		500 x 330	50 x 10	0371 209	198.00
		600 x 400	50 x 10	0371 210	304.00
		750 x 500	60 x 12	0371 211	556.00
	▪	1000 x 660	70 x 15	0371 212	896.00

**DIN  
875**





## 0372 Squares with base accuracy grade 2



### Model

- Special steel
- DIN 875
- Accuracy grade 2
- For angle testing in production and factory

### Delivery

- Cardboard box
- From blade length 1500 mm in a transportation box

**DIN  
875**

☒	☒	Jaw length mm	Cross-section mm	Order no.	List price EUR
		75 x 50	15 x 5	0372 102	14.10
		100 x 70	20 x 5	0372 103	15.80
		150 x 100	25 x 5	0372 104	21.20
		200 x 130	30 x 6	0372 105	27.00
		250 x 165	35 x 7	0372 106	36.10
		300 x 175	35 x 7	0372 107	44.90
		400 x 200	35 x 7	0372 108	67.00
		500 x 250	40 x 8	0372 109	82.00
		600 x 300	40 x 8	0372 110	108.00
		750 x 375	45 x 10	0372 111	136.00
		1000 x 500	50 x 10	0372 112	198.00
	▪	1500 x 750	60 x 12	0372 113	867.00
	▪	2000 x 1000	60 x 12	0372 114	1071.00

## 0373 Squares without base accuracy grade 2



### Model

- Special steel
- DIN 875
- Accuracy grade 2
- For angle testing in production and factory

### Delivery

- Cardboard box
- From blade length 1500 mm in a transportation box

**DIN  
875**

**5**

☒	☒	Jaw length mm	Cross-section mm	Order no.	List price EUR
		75 x 50	15 x 5	0373 102	10.10
		100 x 70	20 x 5	0373 103	11.10
		150 x 100	25 x 5	0373 104	13.60
		200 x 130	30 x 6	0373 105	17.50
		250 x 165	35 x 7	0373 106	22.50
		300 x 175	35 x 7	0373 107	30.30
		400 x 200	35 x 7	0373 108	47.90
		500 x 250	40 x 8	0373 109	67.00
		600 x 300	40 x 8	0373 110	86.00
		750 x 375	45 x 10	0373 111	106.00
		1000 x 500	50 x 10	0373 112	164.00
	▪	1500 x 750	60 x 12	0373 113	788.00
	▪	2000 x 1000	60 x 12	0373 114	947.00



## 0374 Steel squares with base



### Model

- Special steel, zinc coated
- Factory standard
- Simple design for angle test in steel and metal construction

### Delivery

- Cardboard box
- From blade length 1500 mm in a transportation box



✂	📏	Jaw length mm	Cross-section mm	Order no.	List price EUR
		100 x 70	20 x 5	0374 404	11.90
		150 x 100	20 x 5	0374 408	13.30
		200 x 130	20 x 5	0374 410	16.10
		250 x 160	25 x 5	0374 412	19.40
		300 x 180	25 x 5	0374 414	23.70
		400 x 230	30 x 5	0374 416	29.90
		500 x 280	30 x 5	0374 418	39.70
		600 x 330	30 x 5	0374 420	54.00
		750 x 375	30 x 5	0374 424	64.00
		1000 x 500	30 x 5	0374 428	96.00
	▪	1500 x 750	40 x 5	0374 430*	225.00
	▪	2000 x 1000	40 x 5	0374 432*	330.00

\*polished

## 0375 Steel squares without base



### Model

- Special steel, zinc coated
- Factory standard
- Simple design for angle test in steel and metal construction

### Delivery

- Cardboard box
- From blade length 1500 mm in a transportation box



✂	📏	Jaw length mm	Cross-section mm	Order no.	List price EUR
		100 x 70	20 x 5	0375 404	8.70
		150 x 100	20 x 5	0375 408	9.20
		200 x 130	20 x 5	0375 410	9.70
		250 x 160	25 x 5	0375 412	11.90
		300 x 180	25 x 5	0375 414	13.00
		400 x 230	30 x 5	0375 416	17.90
		500 x 280	30 x 5	0375 418	19.80
		600 x 330	30 x 5	0375 420	24.30
		750 x 375	30 x 5	0375 424	28.80
		1000 x 500	30 x 5	0375 428	37.20
	▪	1500 x 750	40 x 5	0375 430*	109.00
	▪	2000 x 1000	40 x 5	0375 432*	164.00

\*polished





## 0376 Squares with hard and slim blade, accuracy grade 1



### Model

### Delivery

**DIN  
875**

- Special steel
- DIN 875
- Accuracy grade 1
- For angle testing in production and factory

- Cardboard box



✕	☞	Jaw length mm	Cross section with narrow beam mm	Cross section with wide beam mm	Order no.	List price EUR
		75 x 50	14 x 3	14 x 10	0376 102	13.90
		100 x 70	16 x 3	16 x 10	0376 103	14.80
		150 x 100	22 x 3	20 x 12	0376 104	18.60
		200 x 130	24 x 3	24 x 14	0376 105	30.60

## 0376 Squares with hard and slim blade, accuracy grade 2



### Model

### Delivery

**DIN  
875**

- Special steel
- DIN 875
- Accuracy grade 2
- For angle testing in production and factory

- Cardboard box



✕	☞	Jaw length mm	Cross section with narrow beam mm	Cross section with wide beam mm	Order no.	List price EUR
		75 x 50	14 x 2	14 x 10	0376 112	13.00
		100 x 70	18 x 2	16 x 10	0376 113	13.80
		150 x 100	22 x 3	20 x 12	0376 114	16.70
		200 x 130	24 x 3	24 x 14	0376 115	23.40
		250 x 160	28 x 3	28 x 16	0376 116	28.90
		300 x 175	30 x 3	32 x 18	0376 117	34.40



## 0390 Squares with hard and slim blade, hardened, accuracy grade 0



### Model

- DIN 875
- Accuracy grade 0
- For exact angle testing (for example: tool making)

### Delivery

- Cardboard box

DIN  
875



▶	☒	Jaw length mm	Cross section with narrow beam mm	Cross section with wide beam mm	Order no.	List price EUR
<b>Special steel</b>						
		50 x 40	16 x 2	14 x 10	0390 102	40.80
		75 x 50	18 x 2	14 x 10	0390 103	40.80
		100 x 70	18 x 2	16 x 10	0390 104	47.30
		150 x 100	22 x 3	20 x 12	0390 105	60.00
		200 x 130	26 x 3	24 x 14	0390 106	82.00
		300 x 200	32 x 3	30 x 18	0390 108	137.00
<b>Stainless steel</b>						
		50 x 40	16 x 2	14 x 10	0390 202	54.00
		75 x 50	18 x 2	14 x 10	0390 203	61.00
		100 x 70	18 x 2	16 x 10	0390 204	78.00
		150 x 100	22 x 3	20 x 12	0390 205	101.00
		200 x 130	26 x 3	24 x 14	0390 206	126.00
		300 x 200	32 x 3	30 x 18	0390 208	193.00

## 0391 Knife edge squares with hard and slim blade, hardened, accuracy grade 00



### Model

- With knife edge
- DIN 875
- Accuracy grade 00
- For exact flatness testing (for example: in production)

### Delivery

- Cardboard box

DIN  
875



▶	☒	Jaw length mm	Cross section with narrow beam mm	Cross section with wide beam mm	Order no.	List price EUR
<b>Special steel, non-glare knife edge</b>						
		50 x 40	16 x 2	14 x 10	0391 102	64.00
		75 x 50	18 x 2	14 x 10	0391 103	64.00
		100 x 70	18 x 2	16 x 10	0391 104	83.00
		150 x 100	22 x 3	20 x 12	0391 105	104.00
		200 x 130	26 x 3	24 x 14	0391 106	140.00
		300 x 200	32 x 3	30 x 18	0391 108	204.00
<b>Stainless steel</b>						
		50 x 40	16 x 2	14 x 10	0391 202	76.00
		75 x 50	18 x 2	14 x 10	0391 203	85.00
		100 x 70	18 x 2	16 x 10	0391 204	96.00
		150 x 100	22 x 3	20 x 12	0391 205	123.00
		200 x 130	26 x 3	24 x 14	0391 206	158.00
		300 x 200	32 x 3	30 x 18	0391 208	256.00





## 0388 Knife edge squares, hardened, accuracy grade 00



### Model

- DIN 875
- Accuracy grade 00
- For exact angle and flatness testing (for example: tool making)

### Delivery

- Cardboard box

**DIN  
875**

Icon	Jaw length mm	Cross-section mm	Order no.	List price EUR
<b>Special steel, non-glare knife edge</b>				
	50 x 40	14 x 4	0388 102	22.80
	75 x 50	15 x 4	0388 103	27.10
	100 x 70	20 x 5	0388 104	32.40
	150 x 100	25 x 6	0388 105	43.60
	200 x 130	30 x 7	0388 106	61.00
	300 x 200	40 x 8	0388 108	106.00
<b>Stainless steel</b>				
	50 x 40	14 x 4	0388 202	27.10
	75 x 50	15 x 4	0388 203	31.80
	100 x 70	20 x 5	0388 204	38.40
	150 x 100	25 x 6	0388 205	49.50
	200 x 130	30 x 7	0388 206	74.00
	300 x 200	40 x 8	0388 208	161.00
	500 x 330	40 x 10	0388 210	762.00

## 0394 Knife edge squares



0394 101

### Model

- **0394101**
- Reading parts are satin chrome finished
- Sliding knife 7 x 7 x 60 mm
- Angle  $\pm 5^\circ$
- Handle 40 x 23 x 9 mm
- For testing on short edges and grooves through the sliding knife edge

### Delivery

- Wooden case

Icon	Dimensions mm	Cross-section mm	Order no.	List price EUR
	60 x 35 x 13	7 x 7 x 100	0394 101	239.00

Accessories	Order no.	List price EUR
Replacement rule for 0394	0394 104	43.20



## 0387 Knife edge squares



### Model

- Stainless steel
- DIN 875
- Accuracy grade 00
- Angle 90°
- Knife edge on the inside

### Delivery

- Cardboard box

**DIN  
875**

✕	📏	Jaw length mm	Cross section with narrow beam mm	Cross section with wide beam mm	Order no.	List price EUR
		25 x 20	5 x 3.5	6 x 3.5	0387 200	20.20
		40 x 28	5 x 3.5	8 x 3.5	0387 201	20.20

## 0397 5 piece inspection set



### Model

set consisting of:

- Knife edge square, stainless steel 75 x 50 mm
- Knife edge square, stainless steel 40 x 28 mm
- Knife edge square, stainless steel 25 x 20 mm
- Knife edge rule, special steel 100 mm
- Gauge block scribe 60 x 9 x 9 mm

### Delivery

- Wooden case

✕	📏	Order no.	List price EUR
		0397 101	208.00



## 0380 Centre squares

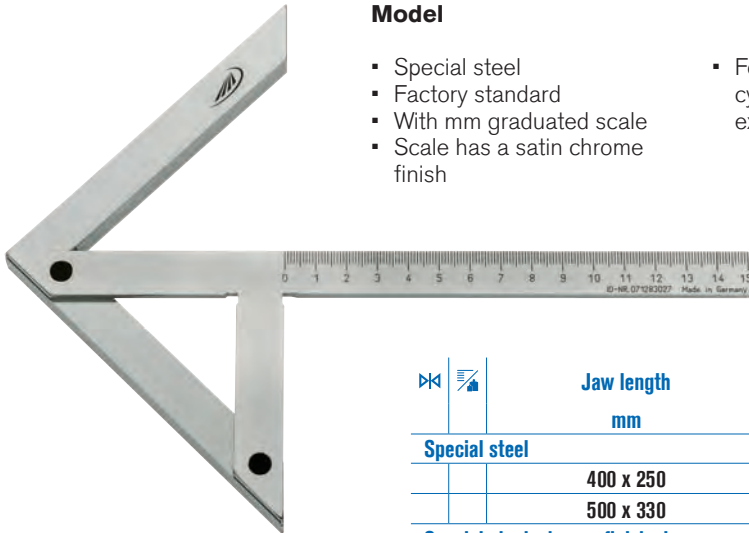

### Model

- Special steel
- Factory standard
- With mm graduated scale
- Scale has a satin chrome finish
- For marking the centre of cylindrical workpieces, for example spindles, slices

### Delivery

- Cardboard box

☒ ☒	Jaw length mm	For shaft dia. up to mm	Order no.	List price EUR
<b>Special steel</b>				
	400 x 250	380	0380 108	296.00
	500 x 330	530	0380 109	526.00
<b>Special steel, chrome finished</b>				
	100 x 70	90	0380 103	65.00
	150 x 130	190	0380 104	77.00
	200 x 150	220	0380 105	96.00
	250 x 160	230	0380 106	106.00
	300 x 180	280	0380 107	115.00

## 0396 Flange squares



### Model

- Special steel, zinc coated
- Factory standard
- For accurately aligning flanges e.g. in plumbing and sanitary works in pipeline

### Delivery

- Cardboard box
- From blade length 600 mm in transportation box

☒ ☒	Jaw length mm	Cross-section mm	Order no.	List price EUR
	300 x 300	30 x 5	0396 414	18.60
	400 x 400	30 x 5	0396 416	22.00
	500 x 500	30 x 5	0396 418	26.00
	▪ 600 x 600	30 x 5	0396 420	32.70
	▪ 800 x 800	30 x 5	0396 426	39.50



## 0395 Mitre squares 120°



### Model

- Special steel
- Factory standard

### Delivery

- Cardboard box

▶	▶	Jaw length mm	Cross-section mm	Order no.	List price EUR
<b>Flat, without base</b>					
		50 x 50	15 x 5	0395 132	9.70
		75 x 75	18 x 5	0395 133	12.40
		100 x 100	20 x 5	0395 134	15.00

## 0395 Mitre squares 135°



### Model

- Special steel
- Factory standard

### Delivery

- Cardboard box

▶	▶	Jaw length mm	Cross-section mm	Order no.	List price EUR
<b>With base</b>					
		120 x 80	20 x 5	0395 142	21.60
		150 x 100	20 x 5	0395 143	24.40
		200 x 130	25 x 5	0395 144	31.80
<b>Flat, without base</b>					
		50 x 50	15 x 5	0395 136	9.70
		75 x 75	18 x 5	0395 137	12.40
		100 x 100	20 x 5	0395 138	15.00
		120 x 80	20 x 5	0395 146	15.90
		150 x 100	20 x 5	0395 147	21.60
		200 x 130	25 x 5	0395 148	29.10



## 0395 Acute angle squares 60°



### Model

- Special steel
- Factory standard

### Delivery

- Cardboard box

		Jaw length mm	Cross-section mm	Order no.	List price EUR
<b>With base</b>					
		120 x 80	20 x 5	0395 122	29.90
		150 x 100	20 x 5	0395 123	34.20
		200 x 130	25 x 5	0395 124	45.80
<b>Flat, without base</b>					
		120 x 80	20 x 5	0395 126	21.50
		150 x 100	20 x 5	0395 127	23.90
		200 x 130	25 x 5	0395 128	33.60

## 0395 Acute angle squares 45°



### Model

- Special steel
- Factory standard

### Delivery

- Cardboard box

		Jaw length mm	Cross-section mm	Order no.	List price EUR
<b>With base</b>					
		120 x 80	20 x 5	0395 102	31.60
		150 x 100	20 x 5	0395 103	35.10
		200 x 130	25 x 5	0395 104	47.30
<b>Flat, without base</b>					
		120 x 80	20 x 5	0395 106	22.30
		150 x 100	20 x 5	0395 107	24.40
		200 x 130	25 x 5	0395 108	35.10



## 0396 Carpenters squares

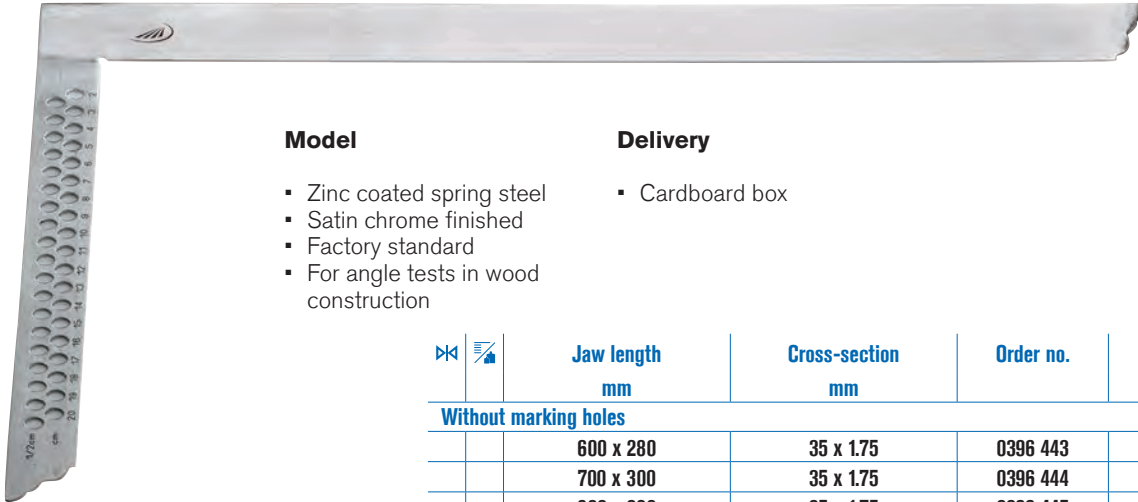

### Model

- Zinc coated spring steel
- Satin chrome finished
- Factory standard
- For angle tests in wood construction

### Delivery

- Cardboard box

Marked	Weight	Jaw length mm	Cross-section mm	Order no.	List price EUR
<b>Without marking holes</b>					
		600 x 280	35 x 1.75	0396 443	11.90
		700 x 300	35 x 1.75	0396 444	14.00
		800 x 320	35 x 1.75	0396 445	15.20
		1000 x 380	35 x 1.75	0396 446	19.50
<b>With marking holes</b>					
		600 x 280	35 x 1.75	0396 453	14.90
		700 x 300	35 x 1.75	0396 454	16.80
		800 x 320	35 x 1.75	0396 455	18.80
		1000 x 380	35 x 1.75	0396 456	22.90

## 0396 Alpha squares with marking holes

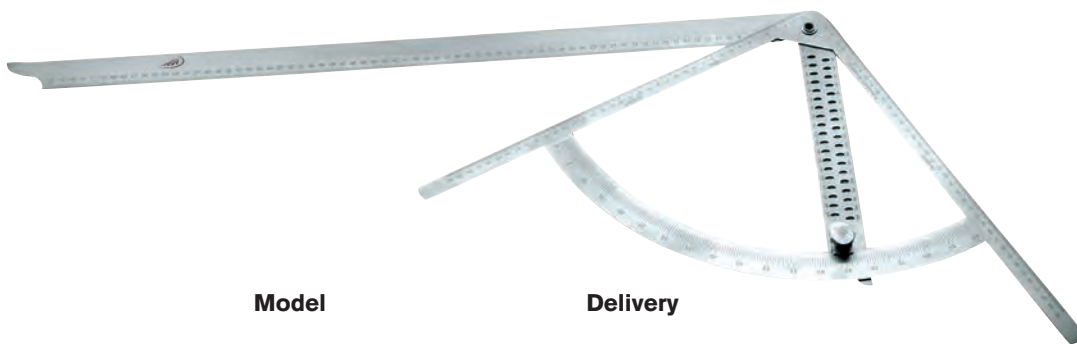

### Model

- Stainless steel
- Long blade with mm graduation, short blade used as adjustable protractor and for marking and production of wood joints 0°-90°

### Delivery

- Cardboard box

Marked	Weight	Jaw length mm	Cross-section mm	Order no.	List price EUR
		430 x 795	35	0396 290	109.00





## 0396 Joiner squares with mitre

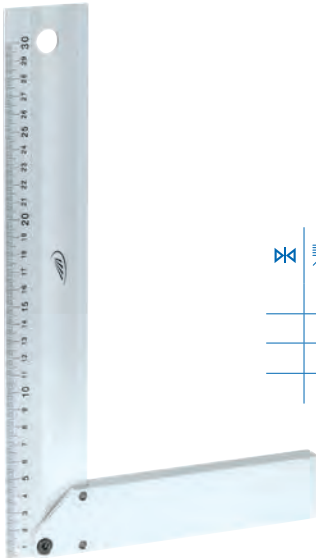



### Model

- Aluminium
- mm graduation

### Delivery

- Cardboard box

 	Jaw length mm	Cross section with narrow beam mm	Cross section with wide beam mm	Order no.	List price EUR
	250 x 148	40 x 14	50 x 5	0396 982	13.50
	300 x 164	40 x 14	50 x 5	0396 983	15.90
	400 x 195	40 x 14	50 x 5	0396 984	19.00

## 0396 Adjustable square





### Model

- Special steel, zinc coated
- Satin chrome finished
- Screw hinge
- For transferring, marking and setting of individual angles

### Delivery

- Cardboard box

 	Jaw length mm	Cross-section mm	Order no.	List price EUR
	200	20 x 8	0396 432	11.10
	250	25 x 8	0396 433	13.70
	300	25 x 8	0396 434	16.70
	400	25 x 8	0396 435	21.50
	500	25 x 8	0396 436	23.90



## 0003 Wooden cases for squares



	Jaw length mm	Internal dimensions L x W x H mm	Order no.	List price EUR
<b>For squares with base</b>				
	150 x 100	160 x 105 x 27	0003 284	7.70
	200 x 130	210 x 135 x 34	0003 286	10.20
	250 x 165	260 x 170 x 38	0003 288	21.80
	300 x 200	312 x 205 x 42	0003 290	21.80
	400 x 265	412 x 270 x 48	0003 292	41.50
	500 x 330	512 x 335 x 54	0003 294	46.80
<b>For flat type squares</b>				
	150 x 100	160 x 105 x 22	0003 283	6.90
	200 x 130	210 x 135 x 27	0003 285	8.70
	250 x 165	260 x 170 x 27	0003 287	9.60
	300 x 200	312 x 205 x 27	0003 289	13.10
	400 x 265	412 x 270 x 27	0003 291	37.60
	500 x 330	512 x 335 x 27	0003 293	41.90
<b>For squares with and without base</b>				
	50 x 40	55 x 45 x 22	0003 280	4.90
	75 x 50	80 x 55 x 22	0003 281	5.30
	100 x 70	105 x 75 x 22	0003 282	5.60





## 0411 Protractors



### Model

- Locking screw
- High precision, laser graduated degree scale
- Factory standard
- 0 - 180°

### Delivery

- Cardboard box

	Jaw length mm	Graduated arc dia. mm	Order no.	List price EUR
<b>Special steel, satin chrome finished graduated arc</b>				
	120	80	0411 301	28.30
	150	120	0411 302	36.50
	200	150	0411 303	40.50
	300	200	0411 304	59.00
	500	300	0411 305	117.00
	600	300	0411 306	147.00
	800	300	0411 307	159.00
	600	400	0411 308	166.00
	800	400	0411 309	175.00
	1000	400	0411 310	216.00

## 0412 Protractors



### Model

- Locking screw
- Stainless steel
- Factory standard
- 0 - 180°
- High precision, laser graduated degree scale

### Delivery

- Cardboard box

	Jaw length mm	Graduated arc dia. mm	Order no.	List price EUR
	120	80	0412 201	39.90
	150	120	0412 202	43.20
	200	150	0412 203	44.50
	300	200	0412 204	62.00



## 0413 Protractors



0413 301

### Model

- Locking screw
- Special steel
- Factory standard
- 0 - 180°
- High precision, laser graduated degree scale
- Graduated in opposite directions
- Satin chrome finished

### Delivery

- Cardboard box



0413 302

	✂	📏	Dimensions	Jaw length	Order no.	List price
			mm	mm		EUR
			Ø 85	150	0413 301	27.00
			85 x 50	150	0413 302	28.10

## 0415 Bevel protractors



### Model

- Locking screw
- Special steel, pointer arm is satin chrome finished
- Factory standard
- Adjustable stop bar 10° - 170°
- High precision, laser graduated degree scale

### Delivery

- Cardboard box

	✂	📏	Jaw length	Graduated arc dia.	Order no.	List price
			mm	mm		EUR
			150	100	0415 301	74.00
			300	150	0415 302	114.00
			400	200	0415 303	155.00
			500	250	0415 304	212.00
			600	300	0415 305	241.00



## 0416 Bevel protractors with double stop rail



### Model

- Locking screw
- Special steel, pointer arm is satin chrome finished
- Factory standard
- Adjustable stop bar  
10° - 170°
- High precision, laser graduated degree scale
- Two-way adjustable stop bar

### Delivery

- Cardboard box

✕	☰	Jaw length	Graduated arc dia.	Order no.	List price
		mm	mm		EUR
		150	100	0416 301	147.00
		300	150	0416 302	192.00
		400	200	0416 303	248.00
		500	250	0416 304	411.00
		600	300	0416 305	476.00



## 0425 DIGI-MET® Universal bevel protractors



### Model

- Clamping unit
- Stainless steel
- Factory standard
- Reversible measuring range:
  - 1 x 360°
  - 2 x 180°
  - 4 x 90°
- Reversible indication
  - degree and minutes
  - decimal degree

### Functions

- ON / OFF
- Set to zero at any point
- Data output Opto RS 232

### Delivery

- Wooden case

✕	☰	Blade length mm	Reading mm	Order no.	List price EUR
		150	0.01° or 1'	0425 701	1486.00
		200	0.01° or 1'	0425 702	1501.00
		300	0.01° or 1'	0425 703	1513.00

### Accessories

	Order no.	List price EUR
data cable opto to RS232	0996 701	87.00
data cable opto to USB	0996 705	166.00



0996701



0996705





## 0420 Universal bevel protractors



### Model

- Locking screw
- Stainless steel
- Factory standard
- Vernier scale reading 5 minutes

### Delivery

- Cardboard box

	Measuring range in °	Blade length mm	Order no.	List price EUR
	4 x 90 °	150 / 200 / 300	0420 522	89.00

### Accessories

	Order no.	List price EUR
Replacement magnifying lense	0420 121	18.40
Replacement blade 150 mm	0420 206	20.80
Replacement blade 200 mm	0420 207	21.80
Replacement blade 300 mm	0420 208	22.00



0420121



0420122



0420124



0420206



# SAMPLES GAUGES

## PLUG GAUGES

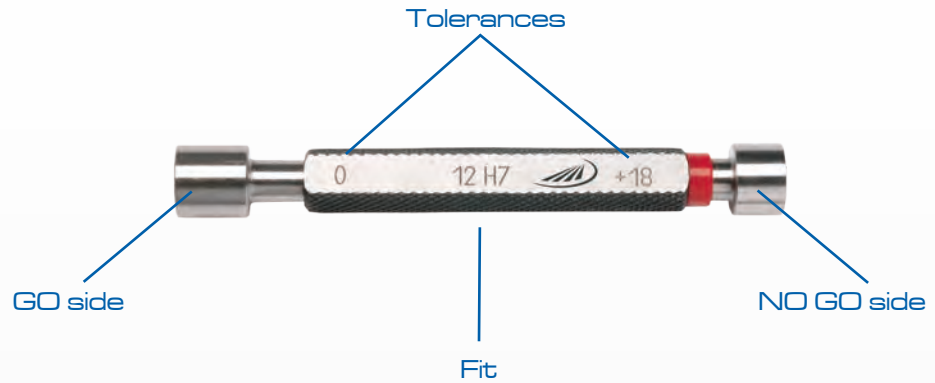

### BESTSELLER:

### FEELER GAUGE **TAPES** IN **SINGLE BOXES**



NOW AVAILABLE FROM **STAINLESS STEEL**



### AS **SET** IN OUR CONVENIENT **WALLHOLDER**

Incl. holder for feeler gauge tapes

## **6. CHAPTER GAUGES, RULES INSPECTION EQUIPMENT**

176	Graduated rules
179	Steel scale tapes for circumference and diameter
180	Edges and rules
183	Knife edge rules
184	Inspection plates made from cast iron
184	Prisms
188	Sets of parallel blocks
189	Levels
190	Combined lathe and thread cutting gauges
192	ISO indicators
194	Grinding / Welding gauges
195	Radius / Chamfer gauge
196	Tapered hole gauges
197	Drill and steel wire hole gauges, radius gauges
198	Feeler gauges
200	Feeler gauge tapes
202	Precision reference sheets
205	Gauge blocks and accessories
213	Pin gauges
214	Snap gauges, setting rings
216	Plug gauges
218	Thread plug- and ring gauges



## 0460 Flexible steel rules



0460 204



0460 222



0460 242

### Model

- Stainless spring band steel
- EC grade II
- Rules with special graduations or other scales are available upon request

	Length mm	Cross-section mm	Order no.	List price EUR
<b>Scales: mm top and bottom</b>				
	150	13 x 0.5	0460 201	1.30
	200	13 x 0.5	0460 202	1.30
	300	15 x 0.5	0460 204	1.90
	500	20 x 0.5	0460 205	4.90
	1000	20 x 0.5	0460 206	10.40
	300	30 x 1.0	0460 207	3.70
	500	30 x 1.0	0460 208	8.70
	1000	30 x 1.0	0460 209	18.10
	1500	30 x 1.0	0460 210	29.10
	2000	30 x 1.0	0460 211	35.10
	3000	30 x 1.0	0460 212	82.00
▪	3000	30 x 2.0	0460 213	126.00
<b>Scales: 1/2 mm top, mm bottom</b>				
	150	13 x 0.5	0460 221	1.30
	200	13 x 0.5	0460 222	1.30
	250	15 x 0.5	0460 223	1.90
	300	15 x 0.5	0460 224	1.90
	500	20 x 0.5	0460 225	4.90
	1000	20 x 0.5	0460 226	10.40
	300	30 x 1.0	0460 227	3.70
	500	30 x 1.0	0460 228	8.70
	1000	30 x 1.0	0460 229	18.10
	1500	30 x 1.0	0460 230	29.10
	2000	30 x 1.0	0460 231	35.10
	3000	30 x 1.0	0460 232	82.00
▪	3000	30 x 2.0	0460 233	126.00
<b>Scales: 1/16", 1/32", 1/64" top; 1/2 mm, 1/1 mm bottom</b>				
	150	13 x 0.5	0460 241	1.30
	200	13 x 0.5	0460 242	1.30
	250	15 x 0.5	0460 243	1.90
	300	15 x 0.5	0460 244	1.90
	500	20 x 0.5	0460 245	4.90
	1000	20 x 0.5	0460 246	10.40
	300	30 x 1.0	0460 247	3.70
	500	30 x 1.0	0460 248	8.70
	1000	30 x 1.0	0460 249	18.10
	1500	30 x 1.0	0460 250	29.10
	2000	30 x 1.0	0460 251	35.10
	3000	30 x 1.0	0460 252	82.00





## 0460 Flexible steel rules, satin chrome



0460 502



0460 522

### Model

- Stainless spring band steel
- Scales satin chrome finished
- EC grade II

		Length mm	Cross-section mm	Order no.	List price EUR
<b>Scales: mm top and bottom</b>					
		150	13 x 0.5	0460 501	3.10
		200	13 x 0.5	0460 502	4.90
		300	15 x 0.5	0460 504	5.60
		500	20 x 0.5	0460 505	12.10
		1000	20 x 0.5	0460 506	24.60
		300	30 x 1.0	0460 507	6.40
		500	30 x 1.0	0460 508	13.30
		1000	30 x 1.0	0460 509	27.80
	▪	1500	35 x 1.5	0460 510	82.00
	▪	2000	35 x 1.5	0460 511	128.00
<b>Scales: 1/2 mm top, mm bottom</b>					
		150	13 x 0.5	0460 521	3.10
		200	13 x 0.5	0460 522	4.90
		300	15 x 0.5	0460 524	5.60
		500	20 x 0.5	0460 525	12.10
		1000	20 x 0.5	0460 526	24.60
		300	30 x 1.0	0460 527	6.40
		500	30 x 1.0	0460 528	13.30
		1000	30 x 1.0	0460 529	27.80

## 0453 Aluminium straight edges, anodized



0453 422

### Model

- Bevelled edge
- Non-glare mm graduation
- Factory standard

		Length mm	Cross-section mm	Order no.	List price EUR
		300	50 x 5	0453 422	10.10
		600	50 x 5	0453 430	14.90
		1000	50 x 5	0453 434	22.00



## 0451 Graduated straight rules acc. to DIN 866, type A



DIN  
866-A

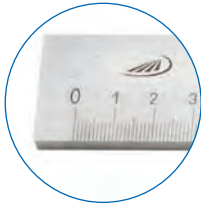

### Model

- Both-sided 10 mm protective ends
- mm graduated scale

### Delivery

- Cardboard box
- From 2000 mm in transportation box

	Length mm	Cross-section mm	Order no.	List price EUR
<b>Special steel</b>				
	500	30 x 6	0451 101	29.10
	1000	40 x 8	0451 102	67.00
▪	1500	40 x 8	0451 103	120.00
▪	2000	50 x 10	0451 104	166.00
▪	3000	50 x 10	0451 105	343.00
▪	4000	60 x 12	0451 106	623.00
<b>Stainless steel</b>				
	500	30 x 6	0451 201	52.00
	1000	40 x 8	0451 202	119.00
▪	1500	40 x 8	0451 203	176.00
▪	2000	50 x 10	0451 204	309.00
▪	3000	50 x 10	0451 205	623.00
▪	4000	60 x 12	0451 206	1125.00

## 0452 Graduated straight rules acc. to DIN 866, type B



DIN  
866-B

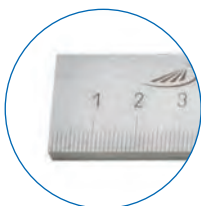

### Model

- Graduated scale begins directly on the end of rule, the other end has a 10 mm protective end
- mm graduated scale

### Delivery

- Cardboard box
- From 2000 mm in transportation box

	Length mm	Cross-section mm	Order no.	List price EUR
<b>Special steel</b>				
	500	25 x 5	0452 101	22.90
	1000	30 x 6	0452 103	45.20
▪	1500	30 x 6	0452 104	66.00
▪	2000	40 x 8	0452 105	108.00
▪	2500	40 x 8	0452 106	170.00
▪	3000	40 x 8	0452 107	188.00
▪	4000	50 x 10	0452 108	358.00
▪	5000	60 x 12	0452 109	643.00
<b>Stainless steel</b>				
	500	25 x 5	0452 201	30.60
	1000	30 x 6	0452 203	67.00
▪	1500	30 x 6	0452 204	114.00
▪	2000	40 x 8	0452 205	181.00
▪	2500	40 x 8	0452 206	345.00
▪	3000	40 x 8	0452 207	359.00
▪	4000	50 x 10	0452 208	645.00
▪	5000	60 x 12	0452 209	1229.00





## 0458 Steel scale tapes for circumference and diameter



0458 104



0458 102

### Model

- Factory standard
- Vernier 0.1 mm
- Main scale graduation 1 mm

### Delivery

- Cardboard box

		For circumference mm	For dia. mm	Order no.	List price EUR
<b>Spring band steel</b>					
		60 - 950	20 - 300	0458 102	43.20
		940 - 2200	300 - 700	0458 103	52.00
		2190 - 3460	700 - 1100	0458 104	67.00
		3450 - 4720	1100 - 1500	0458 105	81.00
		4710 - 5980	1500 - 1900	0458 106	96.00
		5960 - 7230	1900 - 2300	0458 107	111.00
		7220 - 8500	2300 - 2700	0458 108	273.00
		8480 - 9760	2700 - 3100	0458 109	292.00
		9730 - 11010	3100 - 3500	0458 110	376.00
		11000 - 12260	3500 - 3900	0458 111	576.00
		12250 - 13500	3900 - 4300	0458 112	588.00
		13500 - 14760	4300 - 4700	0458 113	599.00
<b>Stainless spring band steel</b>					
		60 - 950	20 - 300	0458 202	77.00
		940 - 2200	300 - 700	0458 203	97.00
		2190 - 3460	700 - 1100	0458 204	119.00
		3450 - 4720	1100 - 1500	0458 205	157.00
		4710 - 5980	1500 - 1900	0458 206	190.00



## 0454 Straight edges, with bevelled edge





### Model

- Special steel
- Zinc coated
- Factory standard

### Delivery

- Cardboard box
- From 2000 mm in transportation box

 	Length mm	Cross-section mm	Order no.	List price EUR
	400	40 x 5	0454 424	10.60
	500	40 x 5	0454 428	13.20
▪	1000	40 x 5	0454 434	26.20
▪	1500	40 x 5	0454 438	47.60
▪	2000	40 x 5	0454 440	73.00
▪	3000	50 x 8	0454 444	191.00

## 0455 Straight edges with bevelled edge, mm graduation





### Model

- Special steel
- Zinc coated
- Factory standard
- Graduated scale begins directly on the end of rule, the other end has a 10 mm protective end

### Delivery

- Cardboard box
- From 2000 mm in transportation box

 	Length mm	Cross-section mm	Order no.	List price EUR
	400	40 x 5	0455 424	19.50
	500	40 x 5	0455 428	24.40
▪	1000	40 x 5	0455 434	46.30
▪	1500	40 x 5	0455 438	83.00
▪	2000	40 x 5	0455 440	121.00
▪	3000	50 x 8	0455 444	255.00





## 0464 Steel rules made of special steel, accuracy grade 0



rectangular cross section

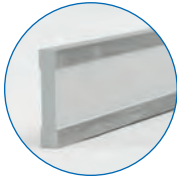

I shaped cross section, 2 hand slots

### Model

- Special steel
- Measuring surfaces are finely grinded
- Flatness of measuring surfaces according to DIN 874

### Delivery

- Cardboard box
- From 2000 mm in transportation box

		Length mm	Cross-section mm	Order no.	List price EUR
<b>Special steel, rectangular cross section</b>					
		500	50 x 10	0464 101	75.00
		750	50 x 10	0464 102	106.00
		1000	60 x 12	0464 103	166.00
	▪	1500	70 x 15	0464 104	280.00
<b>Special steel, I shaped cross section, 2 hand slots</b>					
	▪	2000	80 x 15	0464 105	502.00
	▪	2500	100 x 16	0464 106	853.00
	▪	3000	120 x 20	0464 107	1309.00
	▪	4000	140 x 20	0464 108	2249.00

## 0465 Steel rules made of special steel, accuracy grade 1



		Length mm	Cross-section mm	Order no.	List price EUR
<b>Special steel, rectangular cross section</b>					
		500	40 x 8	0465 101	36.50
		750	50 x 10	0465 102	60.00
		1000	50 x 10	0465 103	82.00
	▪	1500	60 x 12	0465 104	149.00
<b>Special steel, I shaped cross section, 2 hand slots</b>					
	▪	2000	70 x 15	0465 105	303.00
	▪	2500	80 x 15	0465 106	566.00
	▪	3000	100 x 16	0465 107	972.00
	▪	4000	120 x 20	0465 108	1570.00

## 0466 Steel rules made of special steel, accuracy grade 2



		Length mm	Cross-section mm	Order no.	List price EUR
<b>Special steel, rectangular cross section</b>					
		500	30 x 6	0466 101	25.10
		750	40 x 8	0466 102	44.00
		1000	40 x 8	0466 103	51.00
	▪	1500	50 x 10	0466 104	96.00
	▪	2000	60 x 12	0466 105	131.00
	▪	2500	70 x 15	0466 106	289.00
	▪	3000	80 x 15	0466 107	451.00
<b>Special steel, I shaped cross section, 2 hand slots</b>					
	▪	4000	100 x 16	0466 108	1072.00



## 0464 Steel rules made of stainless steel, accuracy grade 0



rectangular cross section

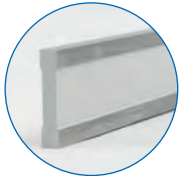

I shaped cross section, 2 hand slots

### Model

- Special steel
- Measuring surfaces are finely grinded
- Flatness of measuring surfaces according to DIN 874

### Delivery

- Cardboard box
- From 2000 mm in transportation box

		Length mm	Cross-section mm	Order no.	List price EUR
<b>Stainless steel, rectangular cross section</b>					
		500	50 x 10	0464 201	118.00
		750	50 x 10	0464 202	161.00
		1000	60 x 12	0464 203	303.00
	▪	1500	70 x 15	0464 204	502.00
<b>Stainless steel, I shaped cross section, 2 hand slots</b>					
	▪	2000	80 x 15	0464 205	928.00
	▪	2500	100 x 16	0464 206	1615.00
	▪	3000	120 x 18	0464 207	2856.00
	▪	4000	140 x 20	0464 208	5095.00

## 0465 Steel rules made of stainless steel, accuracy grade 1



		Length mm	Cross-section mm	Order no.	List price EUR
<b>Stainless steel, rectangular cross section</b>					
		500	40 x 8	0465 201	67.00
		750	50 x 10	0465 202	103.00
		1000	50 x 10	0465 203	185.00
	▪	1500	60 x 12	0465 204	289.00
<b>Stainless steel, I shaped cross section, 2 hand slots</b>					
	▪	2000	70 x 15	0465 205	681.00
	▪	2500	80 x 15	0465 206	1037.00
	▪	3000	100 x 16	0465 207	1998.00
	▪	4000	120 x 18	0465 208	2942.00

## 0466 Steel rules made of stainless steel, accuracy grade 2



		Length mm	Cross-section mm	Order no.	List price EUR
<b>Stainless steel, rectangular cross section</b>					
		500	30 x 6	0466 201	43.20
		750	40 x 8	0466 202	76.00
		1000	40 x 8	0466 203	111.00
	▪	1500	50 x 10	0466 204	230.00
	▪	2000	60 x 12	0466 205	388.00
	▪	2500	70 x 15	0466 206	645.00
	▪	3000	80 x 15	0466 207	921.00
<b>Stainless steel, I shaped cross section, 2 hand slots</b>					
	▪	4000	100 x 16	0466 208	1715.00





## 0512 Knife edge rules



0512 101

**DIN  
874**

### Model

- DIN 874 Sheet 2, accuracy grade 00
- Thermally insulated
- Pointed tip at one end
- Special steel: glare free and burnished knife edge
- Stainless steel: non glare knife edge up to 500 mm

### Delivery

- Up to 500 mm in imitation leather case. From 500 mm individually packed

		Length mm	Cross-section mm	Order no.	List price EUR
<b>Special steel, hardened and grinded</b>					
		75	25 x 5	0512 101	11.90
		100	25 x 5	0512 102	13.30
		125	25 x 5	0512 103	15.00
		150	25 x 5	0512 104	17.10
		200	29 x 7	0512 105	22.30
		300	29 x 7	0512 106	41.90
		400	33 x 10	0512 107	75.00
		500	33 x 10	0512 108	118.00
<b>Stainless steel, hardened and grinded</b>					
		75	25 x 5	0512 201	15.50
		100	25 x 5	0512 202	18.10
		125	25 x 5	0512 203	18.90
		150	25 x 5	0512 204	21.10
		200	29 x 7	0512 205	24.40
		300	29 x 7	0512 206	53.00
		400	33 x 10	0512 207	96.00
		500	33 x 10	0512 208	131.00
		600	45 x 10	0512 209	253.00
		750	60 x 12	0512 210	512.00
		1000	60 x 12	0512 211	671.00

## 0512 Wooden cases for knife edge rules



		Length mm	Order no.	List price EUR
		75	0512 601	6.10
		100	0512 602	6.10
		125	0512 603	6.10
		150	0512 604	7.40
		200	0512 605	8.60
		300	0512 606	9.70
		400	0512 607	12.20
		500	0512 608	18.40
		600	0512 609	18.40
		750	0512 610	36.70
		1000	0512 611	42.80



## 0504 V-blocks (pair)



### Model

- Special cast iron
- 90° grooves
- Machined in pairs

### Delivery

- In pairs
- Cardboard box

		Base dimensions mm	For shaft dia. mm	Accuracy grade	Order no.	List price EUR
<b>Parallelism tolerance &lt; 0.008 mm, V-grooves and base finely grinded</b>						
		100 x 40 x 30	6 - 40	0	0504 012	105.00
		150 x 50 x 40	8 - 50	0	0504 013	164.00
		200 x 70 x 50	8 - 70	0	0504 014	252.00
<b>Parallelism tolerance &lt; 0.016 mm, V-grooves and base grinded</b>						
		100 x 40 x 30	6 - 40	1	0504 112	75.00
		150 x 50 x 40	8 - 50	1	0504 113	100.00
		200 x 70 x 50	8 - 70	1	0504 114	164.00
<b>Parallelism tolerance &lt; 0.064 mm, V-grooves and base milled</b>						
		100 x 40 x 30	6 - 40	3	0504 312	52.00
		150 x 50 x 40	8 - 50	3	0504 313	76.00
		200 x 70 x 50	8 - 70	3	0504 314	124.00





## 0520 V-blocks (pair)



### Model

- Special steel, hardened
- Parallelism from prism to base 0.004 mm
- 90° grooves
- Machined in pairs

### Delivery

- In pairs
- Cardboard box

▶◀	⊗	Base dimensions L x W x H mm	For shaft dia. mm	Order no.	List price EUR
		75 x 35 x 30	5 - 40	0520 101	150.00
		100 x 47 x 40	5 - 55	0520 102	198.00
		150 x 55 x 45	5 - 60	0520 103	262.00
		200 x 65 x 55	5 - 75	0520 104	366.00
		250 x 85 x 70	5 - 100	0520 105	500.00



## 0522 V-blocks with clamp



### Specification

- Stainless special steel, hardened
- Parallelism from prism to base 0,004 mm
- 2 x 90° grooves

### Delivery

- Cardboard box

	Dimensions L x W x H mm	For shaft dia. mm	Order no.	List price EUR
	50 x 40 x 40	5 - 30	0522 201	150.00
	75 x 55 x 55	5 - 50	0522 202	183.00
	100 x 75 x 75	7 - 70	0522 203	263.00

## 0522 Double V-blocks (pairs) with clamp



### Specification

- Stainless special steel, hardened
- Parallelism from prism to base 0.004 mm

### Delivery

- 2 x 90° grooves
- Machined in pairs
- In pairs
- Cardboard box

	Dimensions L x W x H mm	For shaft dia. mm	Order no.	List price EUR
<b>Special steel, hardened</b>				
	50 x 40 x 40	5 - 30	0522 101	230.00
	75 x 55 x 55	5 - 50	0522 102	281.00
	100 x 75 x 75	7 - 70	0522 103	405.00
<b>Stainless special steel, hardened</b>				
	50 x 40 x 40	5 - 30	0522 206	286.00
	75 x 55 x 55	5 - 50	0522 207	348.00
	100 x 75 x 75	7 - 70	0522 208	500.00





## 0524 Double V-blocks (pairs) with clamp lateral tilting



### Specification

- Stainless special steel, hardened
- Flatness, parallelism and symmetry tolerance 0.004 mm
- Right-angled tolerance faces to prism 0.01
- 2 x 90° grooves
- Machined in pairs

### Delivery

- In pairs
- Cardboard box

		Dimensions mm	For shaft dia. mm	Order no.	List price EUR
		60 x 58 x 40	5 - 30	0524 101	254.00
		75 x 70 x 54	5 - 30	0524 102	314.00
		100 x 96 x 75	7 - 70	0524 103	472.00

## 0522 Clamp for double V-blocks



### Delivery

- In pairs
- Cardboard box

		Suitable for prisms	Order no.	List price EUR
		0522 201 / 0522 101 / 0522 206 / 0524 101	0522 111	36.10
		0522 202 / 0522 102 / 0522 207 / 0524 102	0522 112	41.70
		0522 203 / 0522 103 / 0522 208 / 0524 103	0522 113	51.00



## 0525 Adjustable V-blocks 0-60°

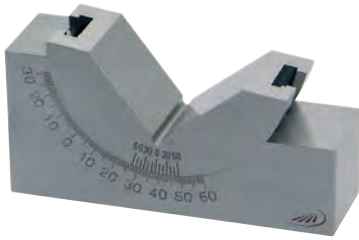

### Model

- Special steel, hardened
- Locking device
- Vernier reading

### Delivery

- Cardboard box

		Dimensions mm	For shaft dia. mm	Order no.	List price EUR
		75 x 25 x 33	4 - 28	0525 101	136.00
		102 x 30 x 46	4 - 40	0525 102	145.00
		102 x 46 x 46	4 - 40	0525 103	155.00

## 0536 Set of parallel blocks



0536 202



0536 211

### Model

- Special steel, hardened

### Delivery

- Wooden case

		Measuring range mm	Height mm	Width mm	Number of devices	Height tolerance µm	Order no.	List price EUR
<b>Set consists of 9 pairs, length 100 mm</b>								
		10 - 42	10 / 14 / 18 / 22 / 26 / 30 / 34 / 38 / 42	4	9	± 5	0536 220	117.00
<b>Set consists of 9 pairs, length 150 mm</b>								
		10 - 42	10 / 14 / 18 / 22 / 26 30 / 34 / 38 / 42	4	9	± 5	0536 230	159.00
<b>Set consists of 14 pairs, length 150 mm</b>								
		14 - 50	14 / 16 / 18 / 20 22 / 24 / 26 / 28 30 / 32 / 35 / 40 45 / 50	10	14	± 5	0536 202	494.00



## 0550 Machine levels

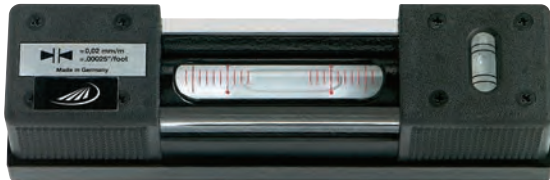

DIN 877

### Model

- DIN 877
- V-groove in the base
- Longitudinal level grinded and graduated
- Transverse level
- Thermally insulated

### Delivery

- Case

⌘	📏	Length mm	Order no.	List price EUR
<b>Reading 0.02 mm/m</b>				
		160	0550 021	318.00
		200	0550 022	349.00
		250	0550 023	380.00
		300	0550 024	412.00
<b>Reading 0.1 mm/m</b>				
		160	0550 101	225.00
		200	0550 102	256.00
		250	0550 103	288.00
		300	0550 104	318.00
<b>Reading 0.3 mm/m</b>				
		160	0550 131	175.00
		200	0550 132	206.00
		250	0550 133	236.00
		300	0550 134	268.00

## 0556 Frame levels



DIN 877

### Model

- DIN 877
- V-grooves on 3 sides
- Longitudinal level
- Grinded and graduated
- Transverse level
- Thermally insulated

### Delivery

- Case

⌘	📏	Dimensions mm	Order no.	List price EUR
<b>Reading 0.02 mm/m</b>				
		150 x 150	0556 022	611.00
		200 x 200	0556 023	698.00
		300 x 300	0556 024	983.00
<b>Reading 0.1 mm/m</b>				
		100 x 100	0556 101	375.00
		150 x 150	0556 102	437.00
		200 x 200	0556 103	547.00
		300 x 300	0556 104	872.00



## 0563 Magnetic angle gauge



### Model

- Centre punch
- Dial face 360°
- Magnetic 90° splayed base

### Delivery

- Cardboard box

	Order no.	List price
	0563 001	EUR 470.00

## 0580 Combined lathe and thread cutting gauge



### Model

- Special steel
- Cuts for trapezoidal (Acme), Whitworth and metric threads

	Dimensions	Measuring range	Order no.	List price
	mm 90 x 40 x 2	in ° 40-80°	0580 101	EUR 8.40

## 0580 Combined lathe and thread cutting gauge



### Model

- Special steel
- Cuts for trapezoidal (Acme), Whitworth and metric threads
- With clearance angle

	Dimensions	Measuring range	Order no.	List price
	mm 90 x 40 x 2	in ° 0-30° and 40-80°	0580 111	EUR 12.10



## 0580 Combined lathe and thread cutting gauge



### Model

- Special steel
- For square threads and trapezoidal threads, Whitworth and metric threads

	Dimensions mm	Order no.	List price EUR
	90 x 40 x 2	0580 121	8.50

## 0595 ACME Thread gauge



### Model

- Special steel
- Cuts for trapezoidal threads

	Dimensions mm	Type of thread	Order no.	List price EUR
	60 x 20 x 2	Trapezoidal threads	0595 130	3.50

## 0595 Thread cutting gauge



### Model

- Special steel
- Cuts for Whitworth or metric threads

	Dimensions mm	Type of thread	Order no.	List price EUR
<b>Metric ISO - threads 60°</b>				
	74 x 24 x 2	Whitworth-thread	0595 142	3.10
<b>Whitworth - threads 55°</b>				
	74 x 24 x 2	Whitworth-thread	0595 140	3.10



## 0581 DIN thread conversion and fit slide rules



0581 101

### Model

- For reading the most important theoretical dimensions of thread tolerance



0581 123

Description	Order no.	List price EUR
<b>Aluminium anodized</b>		
Fine thread slide rule	0581 101	24.40
DIN thread slide rule	0581 103	16.50
DIN fit slide rule	0581 105	22.60
<b>Plastic</b>		
DIN thread slide rule	0581 123	11.90
DIN fit slide rule	0581 125	10.40

## 0582 ISO thread converter - Filetor

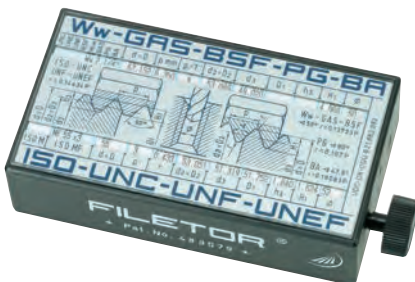

### Model

- For direct reading of all standard information for determining of threads
- Plastic housing

Dimensions mm	Order no.	List price EUR
60 x 30 x 110	0582 110	75.00





## 0582 ISO tolerance indicator - Tolerator



### Model

- For direct reading of all standard information of all ISO-tolerance values
- Plastic housing

☒ ☒	Dimensions	Order no.	List price
	mm		EUR
	60 x 30 x 110	0582 120	75.00

## 0582 mm/inch converter



### Model

- Direct reading of inch to millimeter conversion
- Plastic housing

☒ ☒	Dimensions	Order no.	List price
	mm		EUR
	60 x 30 x 110	0582 130	75.00

## 0589 Profile gauge

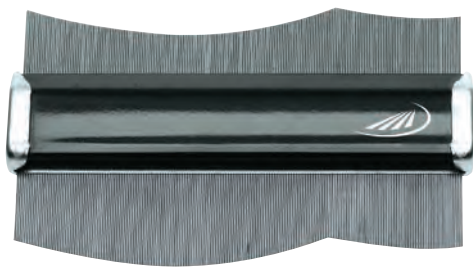

### Model

- Spring pins
- Pin-dia. 1.0 mm

☒ ☒	Dimensions	Order no.	List price
	mm		EUR
	154 x 85	0589 101	19.10
	350 x 150	0589 103	59.00

## 0595 Welding gauge blank



### Model

- Special steel
- Pure
- For easy testing of fillet weld thicknesses of rectangular parts

☒ ☒	For measuring range	Order no.	List price
	mm		EUR
	3 - 12	0595 110	14.90



## 0595 Welding gauge

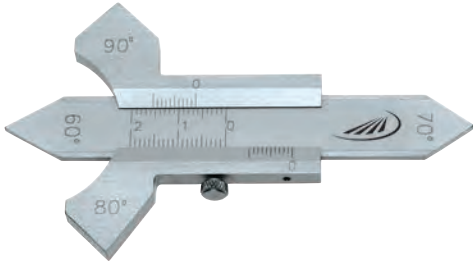

### Ausführung

- Special steel
- Locking screw
- Angel 60°, 70°, 80° and 90°
- to measure the height of flat welds and fillet weld thicknesses

▶▶	▶▶	For measuring range	Reading	Order no.	List price
		mm	mm		EUR
		20 mm	0,10	0595 101	23.90

4,30

## 0595 Welding gauge blank



### Model

- Aluminium
- Pure, for fast reading of the weld dimensions

▶▶	▶▶	For measuring range	Order no.	List price
		mm		EUR
		0 - 5	0595 115	4.30

## 0595 Welding gauge

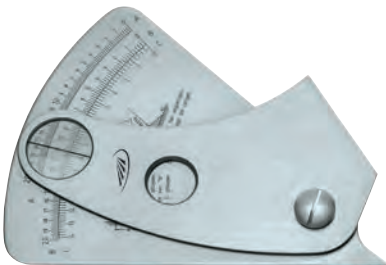

### Model

- Stainless steel
- Reading accuracy 0.2 mm
- Easy to read the result due to the reference line in the reading window
- Quick and easy inspection of welding seam heights

▶▶	▶▶	Dimensions	Order no.	List price
		mm		EUR
		108 x 81.5 x 3.2	0595 251	103.00



## 0597 Radius gauge

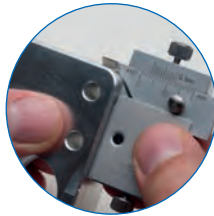

### Model

- To determine radius size work-pieces
- Stainless steel
- Reading parts are satin chrome finished

### Delivery

- Plastic case
- Interchangeable blade: 45°

Measuring range mm	Reading mm	Order no.	List price EUR
0 - 10	0.10	0597 305	198.00

## 0597 Chamfer gauge

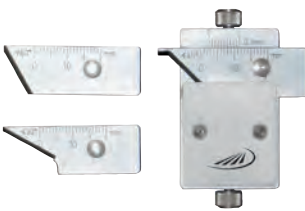

### Model

- Stainless steel
- Reading parts are satin chrome finished
- For simultaneously testing of the chamfer angle and the dimensional accuracy
- Dimensions: 48 x 30 x 8.5 mm

### Delivery

- Plastic case
- 3 interchangeable blades: 30°, 45°, 60°

Measuring range mm	Reading mm	Order no.	List price EUR
0 - 10	0.10	0597 301	198.00

## 0600 Tapered hole gauges



0600 101

### Model

- Reading 0.1 mm

Measuring range mm	Order no.	List price EUR
Special steel, flat		
1 - 15	0600 101	29.10



## 0598 Tapered hole gauges



### Model

- Special steel
- Reading parts matted

	Measuring range mm	Reading mm	Order no.	List price EUR
<b>Special steel</b>				
	0.5 - 7.0	0.10	0598 103	55.00
	2.0 - 7.0	0.10	0598 105	55.00
<b>Plastic</b>				
	0.5 - 11	0.10	0598 601	55.00

## 0599 Nozzle / small hole gauges



### Model

- Special steel
- Cone 1:10
- Nickel plated housing

	Measuring range mm	Reading mm	Order no.	List price EUR
	0 - 5	0.01	0599 102	67.00

## 0599 Nozzle gauges

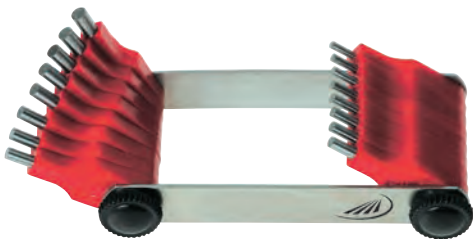

### Model

- With steel pins
- Plastic handle
- Manufacturing tolerance  $\pm 0.01$  mm

	Measuring range mm	Increment mm	Number of pairs	Order no.	List price EUR
	0.45 - 1.5	0.05	20	0599 151	8.10
	1.5 - 3.0	0.1	16	0599 152	8.10



## 0601 Drill and steel wire hole gauges (millimeter)



### Model

- Special steel, nitrided

⌘	☒	Measuring range mm	Increment mm	Order no.	List price EUR
		0.7 - 10	0.1	0601 103	103.00

## 0604 Radius gauges



### Model

- Concave and convex
- Locking nut
- Milled finish

⌘	☒	Measuring range mm	Number of blades	Order no.	List price EUR
<b>Special steel</b>					
		1.0 - 7.0	17	0604 002	7.70
		7.5 - 15	16	0604 004	8.50
		15.5 - 25	15	0604 006	8.50
<b>Stainless steel</b>					
		1.0 - 7.0	17	0604 202	10.20
		7.5 - 15	16	0604 204	12.60
		15.5 - 25	15	0604 206	12.60



## 0605 Screw pitch gauges



☒	☒	Measuring range mm	Number of blades	Description	Order no.	List price EUR
		0.25 - 6.0	24	Metric threads according to ISO	0605 101	2.90
		0.40 - 7.0	20	Combined metric threads according to SI System	0605 102	2.60
		4.00 - 62.0	28	Whitworth threads according to DIN	0605 103	2.60
		8.00 - 28.0	6	Whitworth pipe threads	0605 104	2.60
		0.40 - 7.0 / 4.0 - 62.0	48	Combined metric SI and Whitworth threads	0605 105	3.90
		0.25 - 6.0 / 4.0 - 62.0	52	Combined metric and Whitworth threads	0605 106	4.10
		4.00 - 42.0	30	US - threads	0605 108	3.40
		10.0 - 40.0	14	US - threads SAE	0605 109	3.70
		4.00 - 64.0	22	UNC - threads	0605 110	3.40
		12.0 - 80.0	16	UNF - threads	0605 111	3.40
		4.00 - 26.0	20	BSF - threads	0605 112	3.90

## 0606 / 0607 Feeler gauges



0606 121



0607 201



0607 401

### Model

- Conical blades
- Width 10mm
- Blade length 100 mm
- Locking nut

☒	☒	Measuring range mm	Number of blades	Order no.	List price EUR
<b>Spring band steel</b>					
		0.03 - 0.1	8	0606 121	1.90
		0.05 - 0.5	8	0606 123	1.90
		0.05 - 1.0	13	0606 127	1.90
		0.05 - 1.0	20	0606 130	2.90
		0.1 - 0.5	21	0606 132	3.40
		0.05 - 2.0	21	0606 133	6.40
		0.03 - 1.0	32	0606 136	5.80
<b>Stainless spring band steel</b>					
		0.05 - 0.5	8	0607 201	4.40
		0.05 - 1.0	13	0607 202	6.90
		0.05 - 1.0	20	0607 203	10.00
<b>Brass (anti-magnetic)</b>					
		0.05 - 0.5	8	0607 401	7.50
		0.05 - 1.0	13	0607 402	9.20
		0.05 - 1.0	20	0607 403	13.10



## 0606 Feeler gauges, long version



### Model

- Cylindrical blades
- Width 13 mm

▶	☰	Measuring range	Length	Number of	Order no.	List price
		mm	mm	blades		EUR
		0.05 - 0.5	150	8	0606 150	3.90
		0.05 - 0.5	200	8	0606 152	4.70
		0.05 - 0.5	300	8	0606 154	6.70
		0.05 - 1.0	200	13	0606 160	10.10
		0.05 - 1.0	300	13	0606 162	11.50
		0.05 - 1.0	200	20	0606 170	12.10
		0.05 - 1.0	300	20	0606 172	15.30
		0.1 - 2.0	200	20	0606 176	20.20
		0.1 - 2.0	300	20	0606 178	29.60

## 0608 Feeler gauges, accuracy grade T3



### Model

- Conical blades
- Width 10 mm

▶	☰	Measuring range	Number of	Order no.	List price
		mm	blades		EUR
		0.1 - 0.4	6	0608 140	2.20
		0.05 - 1.0	13	0608 143	5.20
		0.05 - 1.0	20	0608 144	8.20
		0.03 - 1.0	32	0608 149	18.80



## 0612 Feeler gauge tapes in single boxes - INOX



### Model

- Stainless steel
- Width 12.7 mm
- Length 5 m
- Tape from 0.08 mm upwards marked with dimension

### Delivery

- Plastic box

✕	☒	Nominal size mm	Order no.	List price EUR
		0.01	0612 501	51.00
		0.02	0612 502	38.90
		0.03	0612 503	17.00
		0.04	0612 504	17.00
		0.05	0612 505	14.70
		0.06	0612 506	12.40
		0.07	0612 507	12.40
		0.08	0612 508	12.40
		0.09	0612 509	12.40
		0.10	0612 510	12.40
		0.12	0612 512	12.40
		0.15	0612 515	12.40
		0.18	0612 518	12.40
		0.20	0612 520	12.40
		0.25	0612 525	12.40

## 0612 Set of feeler gauge tapes in wallholder - INOX



### Model

- Refillable with selected feeler gauges
- Wall holder made of steel, gloss coated
- With size labels

### Delivery

- With holder and mounting fittings

✕	☒	Dimensions mm	Measuring range mm	Number of boxes	Order no.	List price EUR
		330 x 100 x 110	0.01 - 0.25	15	0612 180	285.00

## 0611 Accessories for feeler gauge tapes



0611 195



0611 197



0611 198

✕	☒	Description	Dimensions mm	Order no.	List price EUR
		Holder for feeler gauge tape	125 x 17	0611 195	3.40
		Wallholder for 0.01 - 0.25 mm	330 x 100 x 110	0611 197	44.00
		Wallholder for 0.3 - 1.0 mm	330 x 210 x 220	0611 198	67.00





## 0611 Feeler gauge tapes in single boxes



### Model

- Hardened carbon steel
- Width 12.7 mm
- Length 5 m
- Tape from 0.08 mm upwards marked with dimension

### Delivery

- Plastic box

☒ ☒	Nominal size mm	Order no.	List price EUR
	0.005	0611 300	90.00
	0.01	0611 501	51.00
	0.02	0611 502	38.90
	0.03	0611 503	14.70
	0.04	0611 504	14.70
	0.05	0611 505	12.40
	0.06	0611 506	10.80
	0.07	0611 507	10.80
	0.08	0611 508	10.80
	0.09	0611 509	10.80
	0.10	0611 510	10.80
	0.12	0611 512	10.80
	0.15	0611 515	10.80
	0.18	0611 518	10.80
	0.20	0611 520	10.80
	0.25	0611 525	10.80
	0.30	0611 530	10.80
	0.35	0611 535	12.40
	0.40	0611 540	12.40
	0.45	0611 545	12.40
	0.50	0611 550	12.40
	0.55	0611 552	18.60
	0.60	0611 554	18.60
	0.65	0611 556	18.60
	0.70	0611 558	18.60
	0.75	0611 560	18.60
	0.80	0611 562	18.60
	0.85	0611 564	18.60
	0.90	0611 566	19.80
	0.95	0611 568	19.80
	1.0	0611 570	19.80

## 0611 Set of feeler gauge tapes in wallholder



### Model

- Refillable with selected feeler gauges
- Wall holder made of steel, gloss coated
- With size labels

### Delivery

- With holder and mounting fittings

☒ ☒	Dimensions mm	Measuring range mm	Number of boxes	Order no.	List price EUR
	330 x 100 x 110	0.01 - 0.25	15	0611 180	261.00
	330 x 210 x 220	0.3 - 1.0	15	0611 190	283.00



## 0613 Precision reference sheets

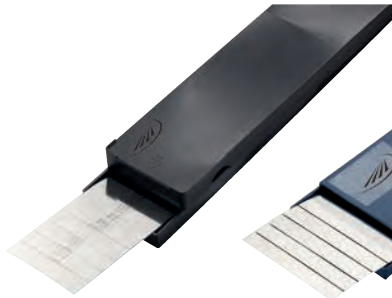

0613 607



0613 709

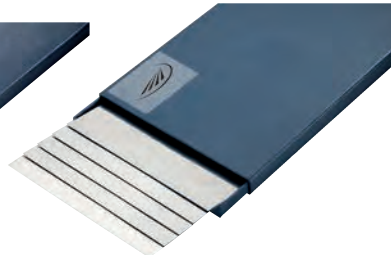

0613 812

Nominal size mm	Carbon steel, 50 x 300 mm, 10 pieces		Stainless steel, 100 x 500 mm, 5 pieces		Stainless steel, 150 x 500 mm, 5 pieces	
	Order no.	List price EUR	Order no.	List price EUR	Order no.	List price EUR
0.01	0613 607	77.00				
0.02	0613 609	41.40	0613 709	58.00		
0.025					0613 812	64.00
0.03	0613 614	29.10				
0.04	0613 616	29.10				
0.05	0613 618	29.10	0613 718	34.50	0613 818	52.00
0.06	0613 620	19.90				
0.07	0613 622	19.90				
0.075					0613 824	52.00
0.08	0613 626	19.90				
0.09	0613 628	19.90				
0.10	0613 630	20.60	0613 730	32.40	0613 830	48.60
0.12	0613 632	20.60				
0.15	0613 634	20.60	0613 734	32.40	0613 834	48.60
0.18	0613 636	20.60				
0.20	0613 638	20.60	0613 738	40.80	0613 838	61.00
0.25	0613 640	20.60			0613 840	61.00
0.30	0613 642	20.60	0613 742	40.80	0613 842	61.00
0.35	0613 644	22.80				
0.40	0613 646	22.80	0613 746	46.00	0613 846	72.00
0.45	0613 648	22.80				
0.50	0613 650	22.80	0613 750	53.00	0613 850	83.00
0.60	0613 652	36.50	0613 752	64.00		
0.70	0613 654	36.50	0613 754	64.00		
0.80	0613 656	36.50	0613 756	77.00		
0.90	0613 658	36.50	0613 758	77.00		
1.00	0613 660	36.50	0613 760	85.00	0613 860	133.00



## 0613 Feeler gauge tapes

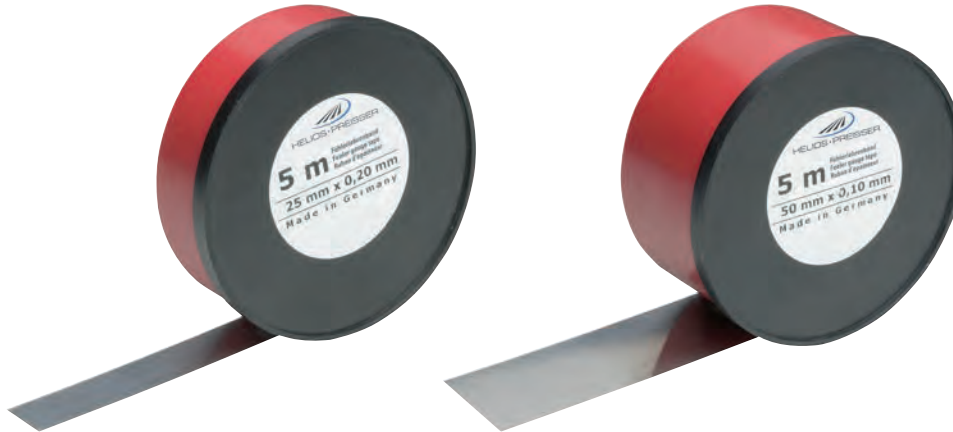

Nominal size mm	Carbon steel, width 25 mm length 5 m		Carbon steel, width 50 mm length 5 m		Stainless steel, width 100 mm length 5 m		Stainless steel, width 150 mm length 5 m	
	Order no.	List price EUR	Order no.	List price EUR	Order no.	List price EUR	Order no.	List price EUR
0.01	0613 107	77.00	0613 207	111.00				
0.02	0613 109	41.40	0613 209	60.00	0613 309	106.00		
0.025							0613 412	121.00
0.03	0613 114	29.10	0613 214	41.90				
0.04	0613 116	29.10	0613 216	41.90				
0.05	0613 118	29.10	0613 218	41.90	0613 318	64.00	0613 418	97.00
0.06	0613 120	19.90	0613 220	28.60				
0.07	0613 122	19.90	0613 222	28.60				
0.075							0613 424	97.00
0.08	0613 126	19.90	0613 226	28.60				
0.09	0613 128	19.90	0613 228	28.60				
0.10	0613 130	20.60	0613 230	29.70	0613 330	60.00	0613 430	93.00
0.12			0613 232	29.70				
0.15	0613 134	20.60	0613 234	29.70	0613 334	60.00	0613 434	93.00
0.18			0613 236	29.70				
0.20	0613 138	20.60	0613 238	29.70	0613 338	77.00	0613 438	117.00
0.25			0613 240	29.70			0613 440	117.00
0.30	0613 142	20.60	0613 242	29.70	0613 342	77.00	0613 442	117.00
0.35			0613 244	32.40				
0.40	0613 146	22.80	0613 246	32.40	0613 346	87.00	0613 446	129.00
0.45			0613 248	32.40				
0.50	0613 150	22.80	0613 250	32.40	0613 350	100.00	0613 450	150.00
0.60	0613 152	36.50	0613 252	53.00	0613 352	119.00		
0.70	0613 154	36.50	0613 254	53.00	0613 354	119.00		
0.80	0613 156	36.50	0613 256	53.00	0613 356	143.00		
0.90	0613 158	36.50	0613 258	53.00	0613 358	143.00		
1.00	0613 160	36.50	0613 260	53.00	0613 360	163.00		



## 0584 Comparative surface roughness standards



### Model

- 6 manufacturing processes
- 30 comparative standards

### Delivery

- Plastic case



Order no.

List price

0584 101

EUR  
358.00



## 0623 Individual steel gauge blocks, tolerance class 0



### Model

- EN ISO 3650
- Special steel, hardened

Nominal size mm	Order no.	List price EUR
0.5	0623 100	47.60
1.0	0623 102	40.30
1.10	0623 170	40.30
1.20	0623 220	40.30
1.30	0623 270	40.30
1.40	0623 320	40.30
1.50	0623 370	40.30
1.60	0623 375	40.30
1.70	0623 380	40.30
1.80	0623 385	40.30
1.90	0623 390	40.30
2.00	0623 395	40.30
2.50	0623 400	42.80
3.00	0623 405	42.80
3.50	0623 410	42.80
4.00	0623 415	42.80
4.50	0623 420	42.80
5.00	0623 425	42.80
5.50	0623 430	42.80
6.00	0623 435	42.80
6.50	0623 440	42.80
7.00	0623 445	42.80
7.50	0623 450	42.80
8.00	0623 455	42.80
8.50	0623 460	42.80
9.00	0623 465	42.80
9.50	0623 470	42.80
10.00	0623 475	52.00
11.00	0623 500	52.00

Nominal size mm	Order no.	List price EUR
12.00	0623 510	52.00
13.00	0623 520	52.00
14.00	0623 530	52.00
15.00	0623 540	52.00
16.00	0623 550	52.00
17.00	0623 560	52.00
18.00	0623 570	52.00
19.00	0623 580	52.00
20.00	0623 590	52.00
21.00	0623 600	52.00
22.00	0623 610	52.00
23.00	0623 620	52.00
24.00	0623 630	52.00
25.00	0623 640	52.00
30.00	0623 650	61.00
40.00	0623 670	61.00
50.00	0623 680	61.00
60.00	0623 690	61.00
70.00	0623 700	61.00
80.00	0623 710	76.00
90.00	0623 720	76.00
100.00	0623 730	91.00
125.00	0623 740	319.00
150.00	0623 750	319.00
175.00	0623 760	319.00
200.00	0623 770	381.00
300.00	0623 780	544.00
400.00	0623 790	706.00
500.00	0623 800	976.00



## 0624 Individual steel gauge blocks, tolerance class 1



### Model

- EN ISO 3650
- Special steel, hardened

Nominal size mm	Order no.	List price EUR
0.5	0624 100	31.70
1.0	0624 102	27.00
1.001	0624 104	27.00
1.002	0624 106	27.00
1.003	0624 108	27.00
1.004	0624 110	27.00
1.005	0624 112	27.00
1.006	0624 114	27.00
1.007	0624 116	27.00
1.008	0624 118	27.00
1.009	0624 120	27.00
1.01	0624 122	27.00
1.02	0624 130	27.00
1.03	0624 135	27.00
1.04	0624 140	27.00
1.05	0624 145	27.00
1.06	0624 150	27.00
1.07	0624 155	27.00
1.08	0624 160	27.00
1.09	0624 165	27.00
1.10	0624 170	27.00
1.11	0624 175	27.00
1.12	0624 180	27.00
1.13	0624 185	27.00
1.14	0624 190	27.00
1.15	0624 195	27.00
1.16	0624 200	27.00
1.17	0624 205	27.00
1.18	0624 210	27.00
1.19	0624 215	27.00
1.20	0624 220	27.00
1.21	0624 225	27.00
1.22	0624 230	27.00
1.23	0624 235	27.00
1.24	0624 240	27.00
1.25	0624 245	27.00
1.26	0624 250	27.00
1.27	0624 255	27.00
1.28	0624 260	27.00
1.29	0624 265	27.00

Nominal size mm	Order no.	List price EUR
1.30	0624 270	27.00
1.31	0624 275	27.00
1.32	0624 280	27.00
1.33	0624 285	27.00
1.34	0624 290	27.00
1.35	0624 295	27.00
1.36	0624 300	27.00
1.37	0624 305	27.00
1.38	0624 310	27.00
1.39	0624 315	27.00
1.40	0624 320	27.00
1.41	0624 325	27.00
1.42	0624 330	27.00
1.43	0624 335	27.00
1.44	0624 340	27.00
1.45	0624 345	27.00
1.46	0624 350	27.00
1.47	0624 355	27.00
1.48	0624 360	27.00
1.49	0624 365	27.00
1.50	0624 370	27.00
1.60	0624 375	27.00
1.70	0624 380	27.00
1.80	0624 385	27.00
1.90	0624 390	27.00
2.00	0624 395	27.00
2.50	0624 400	28.10
3.00	0624 405	28.10
3.50	0624 410	28.10
4.00	0624 415	28.10
4.50	0624 420	28.10
5.00	0624 425	28.10
5.50	0624 430	28.10
6.00	0624 435	28.10
6.50	0624 440	28.10
7.00	0624 445	28.10
7.50	0624 450	28.10
8.00	0624 455	28.10
8.50	0624 460	28.10
9.00	0624 465	28.10

Nominal size mm	Order no.	List price EUR
9.50	0624 470	28.10
10.00	0624 475	34.20
11.00	0624 500	34.20
12.00	0624 510	34.20
13.00	0624 520	34.20
14.00	0624 530	34.20
15.00	0624 540	34.20
16.00	0624 550	34.20
17.00	0624 560	34.20
18.00	0624 570	34.20
19.00	0624 580	34.20
20.00	0624 590	34.20
21.00	0624 600	34.20
22.00	0624 610	34.20
23.00	0624 620	34.20
24.00	0624 630	34.20
25.00	0624 640	34.20
30.00	0624 650	40.30
35.00	0624 660	40.30
40.00	0624 670	40.30
50.00	0624 680	40.30
60.00	0624 690	40.30
70.00	0624 700	40.30
80.00	0624 710	51.00
90.00	0624 720	51.00
100.00	0624 730	60.00
125.00	0624 740	194.00
150.00	0624 750	194.00
175.00	0624 760	194.00
200.00	0624 770	230.00
300.00	0624 780	331.00
400.00	0624 790	428.00
500.00	0624 800	592.00



## 0625 Individual steel gauge blocks, tolerance class 2



### Model

- EN ISO 3650
- Special steel, hardened

Nominal size mm	Order no.	List price EUR
0.5	0625 100	25.60
1.0	0625 102	22.00
1.001	0625 104	22.00
1.002	0625 106	22.00
1.003	0625 108	22.00
1.004	0625 110	22.00
1.005	0625 112	22.00
1.006	0625 114	22.00
1.007	0625 116	22.00
1.008	0625 118	22.00
1.009	0625 120	22.00
1.01	0625 122	22.00
1.02	0625 130	22.00
1.03	0625 135	22.00
1.04	0625 140	22.00
1.05	0625 145	22.00
1.06	0625 150	22.00
1.07	0625 155	22.00
1.08	0625 160	22.00
1.09	0625 165	22.00
1.10	0625 170	22.00
1.11	0625 175	22.00
1.12	0625 180	22.00
1.13	0625 185	22.00
1.14	0625 190	22.00
1.15	0625 195	22.00
1.16	0625 200	22.00
1.17	0625 205	22.00
1.18	0625 210	22.00
1.19	0625 215	22.00
1.20	0625 220	22.00
1.21	0625 225	22.00
1.22	0625 230	22.00
1.23	0625 235	22.00
1.24	0625 240	22.00
1.25	0625 245	22.00
1.26	0625 250	22.00
1.27	0625 255	22.00
1.28	0625 260	22.00
1.29	0625 265	22.00

Nominal size mm	Order no.	List price EUR
1.30	0625 270	22.00
1.31	0625 275	22.00
1.32	0625 280	22.00
1.33	0625 285	22.00
1.34	0625 290	22.00
1.35	0625 295	22.00
1.36	0625 300	22.00
1.37	0625 305	22.00
1.38	0625 310	22.00
1.39	0625 315	22.00
1.40	0625 320	22.00
1.41	0625 325	22.00
1.42	0625 330	22.00
1.43	0625 335	22.00
1.44	0625 340	22.00
1.45	0625 345	22.00
1.46	0625 350	22.00
1.47	0625 355	22.00
1.48	0625 360	22.00
1.49	0625 365	22.00
1.50	0625 370	22.00
1.60	0625 375	22.00
1.70	0625 380	22.00
1.80	0625 385	22.00
1.90	0625 390	22.00
2.00	0625 395	22.00
2.50	0625 400	22.00
3.00	0625 405	22.00
3.50	0625 410	22.00
4.00	0625 415	22.00
4.50	0625 420	22.00
5.00	0625 425	22.00
5.50	0625 430	22.00
6.00	0625 435	22.00
6.50	0625 440	22.00
7.00	0625 445	22.00
7.50	0625 450	22.00
8.00	0625 455	22.00
8.50	0625 460	22.00
9.00	0625 465	22.00

Nominal size mm	Order no.	List price EUR
9.50	0625 470	22.00
10.00	0625 475	27.00
11.00	0625 500	27.00
12.00	0625 510	27.00
13.00	0625 520	27.00
14.00	0625 530	27.00
15.00	0625 540	27.00
16.00	0625 550	27.00
17.00	0625 560	27.00
18.00	0625 570	27.00
19.00	0625 580	27.00
20.00	0625 590	27.00
21.00	0625 600	27.00
22.00	0625 610	27.00
23.00	0625 620	27.00
24.00	0625 630	27.00
25.00	0625 640	27.00
30.00	0625 650	31.70
35.00	0625 660	31.70
40.00	0625 670	31.70
50.00	0625 680	31.70
60.00	0625 690	31.70
70.00	0625 700	31.70
80.00	0625 710	40.30
90.00	0625 720	40.30
100.00	0625 730	47.60
125.00	0625 740	156.00
150.00	0625 750	156.00
175.00	0625 760	156.00
200.00	0625 770	166.00
300.00	0625 780	262.00
400.00	0625 790	308.00
500.00	0625 800	403.00



## 0633 Gauge block holders with rapid adjustment



☒	☒	Measuring range mm	Order no.	List price EUR
		0 - 50	0633 136	206.00
		0 - 100	0633 137	235.00
		0 - 200	0633 138	282.00
		100 - 200	0633 139	259.00
		100 - 300	0633 140	306.00
		200 - 400	0633 141	353.00
		300 - 500	0633 142	399.00
		400 - 600	0633 143	436.00
		500 - 800	0633 144	505.00
		800 - 1000	0633 145	705.00

## 0633 Radiused measuring jaws with cylindrical shoulders / pair



☒	☒	Nominal size mm	Measuring depth mm	Order no.	List price EUR
		4	8	0633 150	242.00
		10	15	0633 151	242.00
		16	20	0633 152	259.00
		20	40	0633 153	317.00
		30	65	0633 154	447.00
		40	95	0633 155	582.00

## 0633 Plane / parallel jaws, pair



### Model

- For external measurement

☒	☒	Dimensions mm	Order no.	List price EUR
<b>For external measurements</b>				
		100 x 9 x 20	0633 174	235.00
		125 x 9 x 20	0633 175	277.00
<b>For internal and external measurements</b>				
		100 x 9 x 20	0633 176	436.00
		125 x 9 x 20	0633 177	517.00

## 0633 Stand for gauge block holder

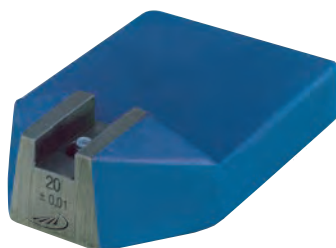

### Model

- Special steel, hardened

☒	☒	Dimensions mm	Order no.	List price EUR
		103 x 70 x 27	0633 182	183.00





0633 Gauge block maintenance set



**Model**

- Set consists of:
- Linen cloth
  - Chamois leather
  - 1 jar of anti corrosion oil
  - Oil stone
  - Fine paint brush
  - Broad paint brush
  - User manual

**Delivery**

- Wooden case

Order no.	List price EUR
0633 001	354.00

0633 Steel gauge block inspection sets for micrometers



**Model**

- EN ISO 3650
- Special steel, hardened
- Tolerance class 1

**Delivery**

- Wooden case

Max. nominal size mm	Order no.	List price EUR
<b>10 pieces, excludes the optical flat</b>		
2.5 / 5.1 / 7.7 / 10.3 / 12.9 / 15.0 / 17.6 / 20.2 / 22.8 / 25.0	0633 810	310.00
<b>5 pieces with optical flat</b>		
5.1 / 10.3 / 15.0 / 20.2 / 25.0	0633 805	383.00
<b>8 pieces with optical flat</b>		
5.1 / 10.3 / 15.0 / 20.2 / 25.0 / 50.0 / 75.0 / 100	0633 808	511.00

0633 Steel gauge block inspection set for calipers



**Model**

- EN ISO 3650
- Special steel, hardened
- Tolerance class 1
- Supplied with setting rings 4 mm and 25 mm

**Delivery**

- Wooden case

For measuring range mm	Max. nominal size mm	Order no.	List price EUR
<b>3 pieces</b>			
200	30.0 / 41.3 / 131.4	0633 833	635.00
<b>4 pieces</b>			
300	30.0 / 41.3 / 131.4 / 243.5	0633 834	847.00
<b>6 pieces</b>			
500	30.0 / 41.3 / 131.4 / 243.5 / 281.2 / 481.1	0633 836	1512.00
<b>5 pieces</b>			
1000	131.4 / 243.5 / 281.2 / 481.1 / 900	0633 838	2673.00



## 0633 Parallel steel gauge block sets



### Model

- EN ISO 3650
- Special steel, hardened

### Delivery

- Wooden case

		Number of gauge blocks	Max. nominal size mm	Increment mm	Order no.	List price EUR
<b>Tolerance class 0</b>						
		103	1.005 1.01 - 1.49 0.5 - 24.5 25.0 - 100.0	- 0.01 0.5 25	0633 014	1002.00
		87	1.001 - 1.009 1.01 - 1.49 0.5 - 9.5 10.0 - 100.0	0.001 0.01 0.5 10	0633 016	916.00
		47	1.005 1.01 - 1.09 1.11 - 1.19 1.1 - 1.9 1.0 - 9.0 10.0 - 100.0	- 0.01 0.01 0.1 1 10	0633 018	596.00
		32	1.005 1.01 - 1.09 1.1 - 1.9 1.0 - 9.0 10.0 - 30.0 50.0	- 0.01 0.1 1 10 -	0633 020	436.00
<b>Tolerance class 1</b>						
		103	1.005 1.01 - 1.49 0.5 - 24.5 25.0 - 100.0	- 0.01 0.5 25	0633 114	771.00
		87	1.001 - 1.009 1.01 - 1.49 0.5 - 9.5 10.0 - 100.0	0.001 0.01 0.5 10	0633 116	588.00
		47	1.005 1.01 - 1.09 1.11 - 1.19 1.1 - 1.9 1.0 - 9.0 10.0 - 100.0	- 0.01 0.01 0.1 1 10	0633 118	363.00
		32	1.005 1.01 - 1.09 1.1 - 1.9 1.0 - 9.0 10.0 - 30.0 50.0	- 0.01 0.1 1 10 -	0633 120	264.00



0633 Parallel steel gauge block sets



**Model**

- EN ISO 3650
- Special steel, hardened

**Delivery**

- Wooden case

		Number of gauge blocks	Max. nominal size mm	Increment mm	Order no.	List price EUR
<b>Tolerance class 2</b>						
		103	1.005 1.01 - 1.49 0.5 - 24.5 25.0 - 100.0	- 0.01 0.5 25	0633 214	487.00
		87	1.001 - 1.009 1.01 - 1.49 0.5 - 9.5 10.0 - 100.0	0.001 0.01 0.5 10	0633 216	385.00
		47	1.005 1.01 - 1.09 1.11 - 1.19 1.1 - 1.9 1.0 - 9.0 10.0 - 100.0	- 0.01 0.01 0.1 1 10	0633 218	263.00
		32	1.005 1.01 - 1.09 1.1 - 1.9 1.0 - 9.0 10.0 - 30.0 50.0	- 0.01 0.1 1 10 -	0633 220	174.00





## 0636 Pin gauge holder



### Model

- Die cast
- With locking screw

		Measuring range	Length	Order no.	List price
		mm	mm		EUR
		1 - 2	60	0636 392	14.90
		2 - 4	68	0636 393	17.10
		4 - 6	76	0636 394	32.40
		6 - 8	84	0636 395	41.50
		8 - 10	92	0636 396	47.80



## 0636 Set of pin gauges

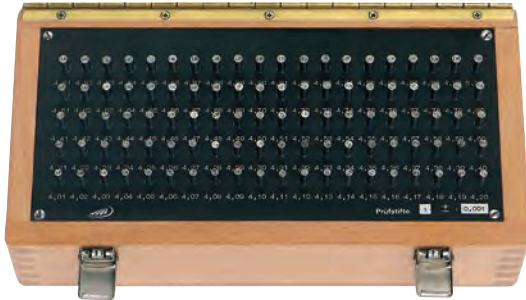

### Model

- DIN 2269
- Made out of high quality gauge steel

### Delivery

- Wooden case

DIN  
2269

☒	☒	Length mm	Number of pins	Max. nominal size mm	Increment mm	Order no.	List price EUR
<b>Special steel, hardened and aged - Tolerance class 1</b>							
		40	51	0.5 - 1.0	0.01	0636 301	916.00
		70	21	1.0 - 2.0	0.05	0636 321	278.00
		70	21	2.0 - 3.0	0.05	0636 322	278.00
		70	21	3.0 - 4.0	0.05	0636 323	343.00
		70	21	4.0 - 5.0	0.05	0636 324	343.00
		70	21	5.0 - 6.0	0.05	0636 325	343.00
		70	21	6.0 - 7.0	0.05	0636 326	419.00
		70	21	7.0 - 8.0	0.05	0636 327	419.00
		70	21	8.0 - 9.0	0.05	0636 328	419.00
		70	21	9.0 - 10.0	0.05	0636 329	419.00
		70	101	1.0 - 2.0	0.01	0636 341	1166.00
		70	100	2.01 - 3.0	0.01	0636 342	1166.00
		70	100	3.01 - 4.0	0.01	0636 343	1477.00
		70	100	4.01 - 5.0	0.01	0636 344	1477.00
		70	100	5.01 - 6.0	0.01	0636 345	1477.00
		70	100	6.01 - 7.0	0.01	0636 346	1817.00
		70	100	7.01 - 8.0	0.01	0636 347	1817.00
		70	100	8.01 - 9.0	0.01	0636 348	1817.00
		70	100	9.01 - 10.0	0.01	0636 349	1817.00
		70	91	1.0 - 10.0	0.1	0636 351	1489.00
		70	81	1.0 - 5.0	0.05	0636 352	1353.00
<b>Special steel, hardened and aged - Tolerance class 2</b>							
		70	101	1.0 - 2.0	0.01	0636 372	815.00
		70	100	2.01 - 3.0	0.01	0636 373	815.00
		70	100	3.01 - 4.0	0.01	0636 374	1073.00
		70	100	4.01 - 5.0	0.01	0636 375	1073.00
		70	100	5.01 - 6.0	0.01	0636 376	1073.00
		70	100	6.01 - 7.0	0.01	0636 377	1300.00
		70	100	7.01 - 8.0	0.01	0636 378	1475.00
		70	100	8.01 - 9.0	0.01	0636 379	1475.00
		70	100	9.01 - 10.0	0.01	0636 380	1475.00



## 0643 Snap gauge, double jaw



### Model

- Dimensions 3 to 100 mm
- Gauge steel
- Hardened measuring faces
- Dimensions acc. DIN 2230
- Manufacturing tolerances: according to DIN 7163

### Delivery

- Available on request
- **Important: Please mention dimension and fit**

## 0649 Adjustable snap gauges



### Model

- Special cast iron
- 1 fixed measuring face, 2 adjustable square measuring faces

### Delivery

- Cardboard box

Marked	Max. nominal size mm	Order no.	List price EUR
	0 - 6	0649 201	82.00
	6 - 13	0649 202	82.00
	13 - 19	0649 203	82.00
	19 - 26	0649 204	84.00
	26 - 32	0649 205	84.00
	32 - 38	0649 206	88.00
	38 - 44	0649 207	88.00
	44 - 51	0649 208	92.00
	51 - 57	0649 209	92.00
	57 - 64	0649 210	96.00

Marked	Max. nominal size mm	Order no.	List price EUR
	64 - 70	0649 211	96.00
	70 - 78	0649 212	105.00
	78 - 87	0649 213	105.00
	87 - 97	0649 215	117.00
	97 - 106	0649 216	133.00
	106 - 116	0649 217	133.00
	116 - 125	0649 219	159.00
	125 - 135	0649 220	207.00
	135 - 144	0649 222	237.00
	144 - 156	0649 223	237.00



## 0656 Ring gauges



### Model

- DIN 2250-1 (C)
- Hardened gauge steel
- For setting internal measuring instruments

**DIN**  
**2250-1**

⌂	📏	Nominal size	Order no.	List price	⌂	📏	Nominal size	Order no.	List price
		mm		EUR			mm		EUR
		12,5	0656 303	57.00			52	0656 353	108.00
		17,5	0656 304	85.00			55	0656 354	118.00
		225	0656 305	1007.00			58	0656 355	122.00
		275	0656 306	1108.00			60	0656 356	128.00
		3	0656 309	65.00			62	0656 357	131.00
		3,5	0656 310	57.00			65	0656 358	139.00
		4	0656 311	57.00			68	0656 359	149.00
		4,5	0656 312	57.00			70	0656 360	155.00
		5	0656 313	56.00			72	0656 361	161.00
		6	0656 314	54.00			75	0656 362	165.00
		7	0656 315	54.00			78	0656 363	174.00
		8	0656 316	54.00			80	0656 364	180.00
		9	0656 317	54.00			82	0656 365	190.00
		10	0656 318	54.00			85	0656 366	202.00
		11	0656 319	56.00			88	0656 367	216.00
		12	0656 320	57.00			90	0656 368	223.00
		13	0656 321	58.00			92	0656 369	232.00
		14	0656 322	58.00			95	0656 370	247.00
		15	0656 323	59.00			98	0656 371	259.00
		16	0656 324	59.00			100	0656 372	268.00
		17	0656 325	60.00			105	0656 373	280.00
		18	0656 326	60.00			110	0656 374	295.00
		19	0656 327	61.00			115	0656 375	307.00
		20	0656 328	64.00			120	0656 376	321.00
		21	0656 329	64.00			125	0656 377	335.00
		22	0656 330	64.00			130	0656 378	346.00
		23	0656 331	67.00			135	0656 379	361.00
		24	0656 332	68.00			140	0656 380	374.00
		25	0656 333	69.00			145	0656 381	387.00
		26	0656 334	72.00			150	0656 382	401.00
		27	0656 335	72.00			155	0656 383	438.00
		28	0656 336	73.00			160	0656 384	473.00
		30	0656 337	67.00			165	0656 385	508.00
		32	0656 338	76.00			170	0656 386	545.00
		33	0656 339	76.00			175	0656 387	582.00
		34	0656 340	77.00			180	0656 388	617.00
		35	0656 341	77.00			185	0656 389	654.00
		36	0656 342	78.00			190	0656 390	689.00
		37	0656 343	81.00			195	0656 391	726.00
		38	0656 344	82.00			200	0656 392	761.00
		40	0656 345	83.00			210	0656 393	803.00
		42	0656 346	87.00			220	0656 394	838.00
		44	0656 347	92.00			230	0656 395	877.00
		45	0656 348	94.00			240	0656 396	917.00
		46	0656 349	96.00			250	0656 397	956.00
		47	0656 350	100.00			260	0656 398	996.00
		48	0656 351	102.00			270	0656 399	1033.00
		50	0656 352	105.00					



## 0637 Plug gauges



### Model

- Manufacturing tolerances: according to DIN 7150-2 and DIN 7164
- Fit H7
- All cylindrical

✂	📏	Dimensions acc. to Din	Nominal size mm	Order no.	List price EUR
<b>Gauge steel, hardened</b>					
		2245-1	2	0637 103	35.10
		2245-1	2.2	0637 104	35.10
		2245-1	2.5	0637 105	35.10
		2245-1	2.8	0637 106	25.50
		2245-1	3	0637 107	25.50
		2245-1	3.5	0637 108	22.80
		2245-1	4	0637 109	22.80
		2245-1	4.5	0637 110	22.80
		2245-1	5	0637 111	21.60
		2245-1	6	0637 112	21.60
		2245-1	7	0637 113	22.80
		2245-1	8	0637 114	22.80
		2245-1	9	0637 115	24.40
		2245-1	10	0637 116	25.50
		2245-1	11	0637 117	25.50
		2245-1	12	0637 118	27.10
		2245-1	13	0637 119	28.30
		2245-1	14	0637 120	28.30
		2245-1	15	0637 121	29.10
		2245-1	16	0637 122	29.10
		2245-1	17	0637 123	30.50
		2245-1	18	0637 124	31.60
		2245-1	19	0637 125	31.60
		2245-1	20	0637 126	31.60
		2245-1	21	0637 127	33.30
		2245-1	22	0637 128	34.00
		2245-1	23	0637 129	35.10
		2245-1	24	0637 130	35.10
		2245-1	25	0637 131	36.50
		2245-1	26	0637 132	37.90
		2245-1	27	0637 133	37.90
		2245-1	28	0637 134	39.00
		2245-1	30	0637 135	39.00
		2245-1	32	0637 136	43.20

✂	📏	Dimensions acc. to Din	Nominal size mm	Order no.	List price EUR
		2245-1	33	0637 137	44.00
		2245-1	34	0637 138	45.20
		2245-1	35	0637 139	45.20
		2245-1	36	0637 140	46.40
		2245-1	37	0637 141	47.30
		2245-1	38	0637 142	48.60
		2245-1	40	0637 144	51.00
		2245-2	42	0637 146	52.00
		2245-2	43	0637 147	64.00
		2245-2	44	0637 148	56.00
		2245-2	45	0637 149	57.00
		2245-2	46	0637 150	58.00
		2245-2	47	0637 151	60.00
		2245-2	48	0637 152	61.00
		2245-2	50	0637 154	64.00
		2245-2	52	0637 155	67.00
		2245-2	55	0637 156	72.00
		2245-2	58	0637 157	76.00
		2245-2	60	0637 158	78.00
		2245-2	62	0637 159	83.00
		2245-2	65	0637 160	83.00
		2245-2	68	0637 161	91.00
		2245-2	70	0637 162	92.00
		2245-2	72	0637 163	94.00
		2245-2	75	0637 164	100.00
		2245-2	78	0637 165	104.00
		2245-2	80	0637 166	105.00
		2245-2	82	0637 167	108.00
		2245-2	85	0637 168	112.00
		2245-2	88	0637 169	118.00
		2245-2	90	0637 170	119.00
		2245-2	92	0637 171	122.00
		2245-2	95	0637 172	124.00
		2245-2	98	0637 173	129.00
		2245-2	100	0637 174	131.00





## 0637 Plug gauge set



### Model

- DIN 2245
- Hardened gauge steel
- GO and NO GO

### Delivery

- Wooden box

DIN  
2245

✕	☰	Number of gauges	ISO fit	Nominal size mm	Order no.	List price EUR
		(3, 4, 5, 6, 8, 10, 12)				
		7	H7	3 - 12	0637 190	167.00



## 0658 Thread plug gauges



**DIN  
2280**

### Model

- DIN 2280
- For standard metric ISO threads DIN 13
- Gauge steel, hardened

✂	📏	ISO Fit	Type of thread	Nominal size	Thread pitch	Order no.	List price
				mm	mm		EUR
		6H	M	3.0	0.50	0658 009	77.00
		6H	M	4.0	0.70	0658 011	73.00
		6H	M	5.0	0.80	0658 012	72.00
		6H	M	6.0	1.00	0658 013	68.00
		6H	M	8.0	1.25	0658 015	72.00
		6H	M	10.0	1.50	0658 017	76.00
		6H	M	12.0	1.75	0658 019	82.00

## 0658 Set of thread plug gauges



### Delivery

- Wooden box

**DIN  
2280**

✂	📏	Tolerance class	Type of thread	Max. nominal size mm	Order no.	List price EUR
		(M3, M4, M5, M6, M8, M10, M12)				
		6H	M	M3 - M12	0658 090	285.00

## 0658 GO thread ring gauges



### Model

- DIN 2285-1
- GO thread ring gauge
- For standard metric ISO threads DIN 13
- Hardened gauge steel

**DIN  
2285-1**

✂	📏	ISO Fit	Type of thread	Nominal size mm	Thread pitch mm	Order no.	List price EUR
		6g	M	3.0	0.50	0658 509	60.00
		6g	M	4.0	0.70	0658 511	56.00
		6g	M	5.0	0.80	0658 512	56.00
		6g	M	6.0	1.00	0658 513	56.00
		6g	M	8.0	1.25	0658 515	57.00
		6g	M	10.0	1.50	0658 517	67.00
		6g	M	12.0	1.75	0658 519	78.00



## 0658 NO GO thread ring gauges



### Model

- DIN 2299-1
- NO GO thread ring gauge
- For standard metric ISO threads DIN 13
- Hardened gauge steel

**DIN**  
2299-1

☒	☒	ISO Fit	Type of thread	Nominal size mm	Thread pitch mm	Order no.	List price EUR
		6g	M	3.0	0.50	0658 609	60.00
		6g	M	4.0	0.70	0658 611	56.00
		6g	M	5.0	0.8	0658 612	56.00
		6g	M	6.0	1.0	0658 613	56.00
		6g	M	8.0	1.25	0658 615	57.00
		6g	M	10.0	1.5	0658 617	67.00
		6g	M	12.0	1.75	0658 619	78.00

## 0658 Thread ring gauges GO



### Model

- 7-pieces
- Hardened gauge steel
- For standard metric ISO threads DIN 13
- Fit 6g

### Delivery

- Wooden case

**DIN**  
2285-1

☒	☒	ISO Fit	Type of thread	Nominal size mm	Order no.	List price EUR
		(M3, M4, M5, M6, M8, M10, M12)				
		6g	M	3 - 12	0658 590	285.00

## 0658 Thread ring gauges NO GO

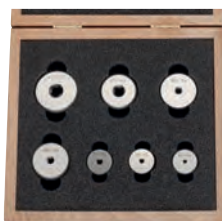

### Model

- 7-pieces
- Hardened gauge steel
- For standard metric ISO threads DIN 13

### Delivery

- Wooden case

**DIN**  
2299-1

☒	☒	ISO Fit	Type of thread	Nominal size mm	Order no.	List price EUR
		(M3, M4, M5, M6, M8, M10, M12)				
		6g	M	3 - 12	0658 690	285.00

# SAMPLES DATA TRANSMISSION

 **integrated  
IW wireless**

**NO CABLE**  
**NO RADIO MODULE**

Thanks to the integrated wireless system our measuring devices from series **i** offer simple data transmission without additional cables

Transmission of data directly to MS Excel® or into any application on Windows via keyboard interface

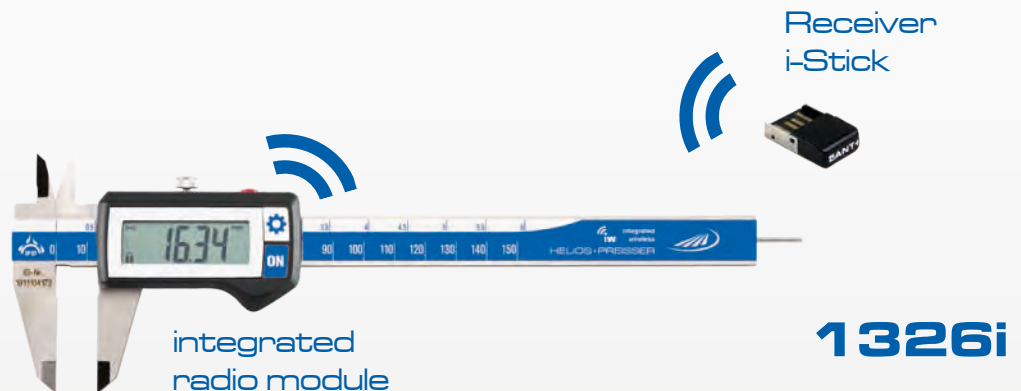

---

**DATA Variable**

**ONE INTERFACE**  
**MANY OPTIONS**



OUT **STANDARD** FOR  
DATA TRANSMISSION  
**WITH CABLES**

USB + RS 232 + DIGIMATIC

## 7. CHAPTER DATA TRANSMISSION

222 Data cables Data Variable / Software

223 Data cables Opto / BlueDat

234 Integrated Wireless



## 1998 / 1997 Data cable DATA VARIABLE



### Our Interface: Data Variable



#### DATA-Button

To transfer the measured results

### Possible connections



USB

RS 232

Digimatic

### Model

- Available for all DIGI-MET measuring instruments with a variable data output (DATA VARIABLE)
- Length 2 m
- With a data transfer button on the plug-in jack
- For use with MarCom Professional software to transfer the measured results to PC, laptop or workstation



1998 720



1997 501

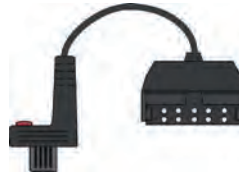

1998 501

	Description	Order no.	List price EUR
	Cable DataVariable for RS 232	1997 501	57.00
	Cable DataVariable for Digimatic	1998 501	73.00
	Cable DataVariable for USB	1998 720	82.00
<b>Bidirectional (for suitable micrometers only)</b>			
	Data cable bidirectional DataVariable to USB	1998 801	111.00
	Data cable bidirectional DataVariable to Digimatic	1998 802	96.00

## 1998 Software MarCom Professional



### Model

Software for easy data acquisition, for all measuring instruments with variable data output (DATA VARIABLE) and integrated wireless (IW)

- Connection to more than 100 measuring instruments with USB data cable possible
- Data transmission with virtual interface box MUX 50 format possible
- Connection of two serial COM-interfaces possible
- Several foot switches via USB connectable, the measuring instruments can be freely assigned
- USB Hubs connectable as measuring instrument interface
- Wireless data transfer with Integrated Wireless (IW) devices
- Wireless data transfer via **blueDAT**

### System requirements

IBM AT compatible PC, MS Windows 7 / 8 / 10, USB-interface from version 2.0 MS EXCEL® from version 97

**DOWNLOAD FOR FREE**  
www.helios-preisser.de

	Description	Order no.
	MarCom Professional	1998 710



## 1998 Accesories for data aquisition with MarCom

**Example: possible measuring station setup**

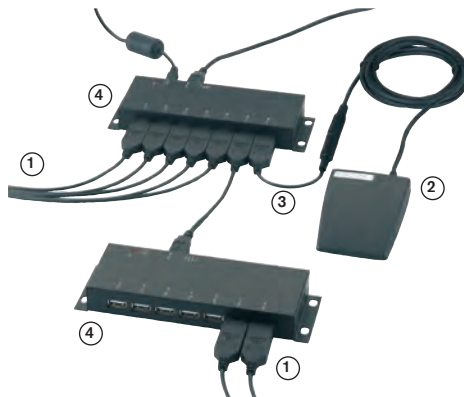

**Model**

1. USB-cable to devices
2. Foot switch with jack plug
3. USB-adapter-cable for foot switch
4. USB-hub for connecting several devices

☒ ☒	Description	Order no.	List price EUR
	Cable DataVariable for USB	1998 720	82.00
	USB-adapter cable for foot switch	1998 722	68.00
	USB-hub sevenfold with plug-in power supply	1998 730	136.00
	Foot-switch* (length of the cable 2 m)	1998 732	82.00

\* To connect to the MarCom, the USB-adapter cable Ref. No. 1998 722 is required

## 0996 Data cable opto



0996 701



0996 705

☒ ☒	Description	Order no.	List price EUR
	Cable Opto for RS232	0996 701	87.00
	Cable Opto for USB	0996 705	166.00

## 1998 blueDAT - wireless data transmission (bluetooth)



1998 740



1998 742



1998 744



1998 746



1998 748

**Model**

Available for all DIGI-MET measuring instruments with a variable data output (DATA VARIABLE)

- Reach: approx. 10 m
- With a data transfer button on the plug-in jack
- USB receiver for use with MarCom Professional software to transfer the measured results to PC, laptop or workstation

☒ ☒	Description	Order no.	List price EUR
	blueDAT USB receiver	1998 740	114.00
	blueDAT for DATA Variable	1998 742	410.00
	blueDAT for RS 232 opto	1998 744	410.00
	blueDAT for RS 232 Proximity	1998 746	561.00
	blueDAT for RS 232 Power (Powered through cable)	1998 748	561.00



## 1998 i-Stick USB-receiver for Integrated Wireless



# integrated iW wireless

Wireless Data Transmission



☒	☒	Number of channels	Frequency band	Radio range	Number of i-Sticks per workspace	Number of devices max.	For measuring instruments	Order no.	List price
			MHz						EUR
		3	2400	up to 6 meters	4	32 (8 per i-Stick)	1326i / 1371i / 1726i / 1734i / 1866i	1998 780	108.00





## 1998 i-Stick USB-receiver for Integrated Wireless



### Description

- **Measurement without the nuisance of additional modules:** Unlike conventional wireless solutions, which have a large external transmitter with separate battery, the transmitter in Integrated Wireless is fully integrated.
- **Highly mobile:** Integrated Wireless gives you much more mobility. There is no cable to get in the way, either at the measuring station or when measuring on or at the machine or at large workpieces
- **Easy data transfer:** With Integrated Wireless you can transfer your measured values to the PC simply using the i-Stick. As with a data cable, the measured values are accepted via the MarCom software directly into MS Excel® or via a keyboard code into any Windows application
- **Reliable transfer:** With Integrated Wireless you can be sure that your data will arrive safely. Measuring instruments with Integrated Wireless display messages to confirm whether the transmitted data has been correctly transferred or whether you are within receiving range of the i-Stick receiver
- **Long battery life:** The integrated wireless interface makes the measuring instrument exceptionally energy-efficient. And unlike conventional wireless systems, no additional battery is required
- **Affordable:** With Integrated Wireless you can connect up to 8 measuring instruments per i-Stick receiver. Expensive interface boxes are no longer necessary. With even one connected measuring instrument you get a wireless connection for the price of a cable

7

## CALIBRATIONS

**Calibration certificates**  
directly from the **expert**

**Certificates of quality** are already **included**  
for **selected products**



## 8. CHAPTER CALIBRATION SERVICE ORDER NUMBER INDEX AND KEYWORD INDEX

228 Calibration service

232 Order number index

244 Keyword index





## Free initial calibration available with many of our products



All HELIOS-PREISSER measuring instruments with a  marked in the column (=Calibration), will undergo initial calibration and are supplied with a certificate at no extra charge! No separate order is required for these articles to be pre-calibrated on delivery. For all other gauges and measuring instruments and for subsequent calibration the following calibration services are offered. Testing is carried out in accordance with VDI / VDE / DGQ guidelines 26 ff.

## Calibration service





**Calipers / Depth gauges / Height gauges** analogue or digital (1 graduation)

		Max. measuring range	Order no.	List price
		mm		EUR
		150	4310 110	14.50
		300	4310 115	25.10
		500	4310 120	43.50
		1000	4310 125	90.00

**Micrometers according to DIN 863-1**

		Max. measuring range	Order no.	List price
		mm		EUR
		25	4320 210	24.00
		100	4320 212	32.00
		200	4320 214	35.00
		300	4320 220	38.00
		500	4320 224	51.00
		1000	4320 228	70.00

**Micrometers with interchangeable inserts** including setting standard

		Max. measuring range	Order no.	List price
		mm		EUR
		100	4320 810	149.00
		200	4320 814	212.00
		300	4320 818	227.00
		400	4320 822	232.00
		500	4320 826	232.00
		600	4320 830	232.00
		700	4320 834	296.00
		800	4320 838	296.00
		900	4320 842	296.00
		1000	4320 846	296.00

**DAkKS Calibration for Calipers / Depth gauges** analogue or digital (1 graduation)

		Max. measuring range	Order no.	List price
		mm		EUR
<b>Pocket and workshop calipers</b>				
		300	4380 110	40.50
		500	4380 112	55.00
		1000	4380 114	99.00

**Depth gauges**

		300	4380 120	40.00
		500	4380 122	55.00
		1000	4380 124	99.00



**Depth gauges with hook**

		300	4380 130	53.00
		500	4380 132	83.00
		1000	4380 134	100.00

**DAkKS Calibration for micrometers according to DIN 863-1** analogue or digital (1 graduation)

		Measuring range	Order no.	List price
		mm		EUR
		0 - 25	4380 140	50.00
		0 - 100	4380 142	55.00

**Setting standards for micrometers** Tolerance zone js2

		Max. measuring range	Order no.	List price
		mm		EUR
		100	4329 010	8.50
		250	4329 026	19.40
		1000	4329 046	39.00



## Calibration service



### Indicators, analogue and digital readings/resolution 0.01 and 0.001

		Measuring span	Order no.	List price
		mm		EUR
		13	4360 210	30.00
		30	4360 212	42.00
		50	4360 214	48.00
		100	4360 218	52.00

### DAkkS Calibration for Indicators, analogue and digital readings/resolution 0.01 and 0.001

		Measuring span	Order no.	List price
		mm		EUR
		Up to 10	4380 150	61.00
		10	4380 151	66.00
		30	4380 152	77.00
		50	4380 154	88.00
		100	4380 156	124.00

### Internal micrometers analogue and digital

		Max. measuring range	Order no.	List price
		mm		EUR
		0 - 100	4322 810	53.00

### DAkkS Calibration for internal micrometers analogue and digital

		Max. measuring range	Order no.	List price
		mm		EUR
		2 - 100	4380 160	79.00

### Universal bevel protractor analogue or digital (1 blade)

		Max. measuring range	Order no.	List price
		in °		EUR
		360	4342 610	32.00

### DAkkS Calibration for universal bevel protractor analogue or digital (1 blade)

		Max. measuring range	Order no.	List price
		in °		EUR
		360	4380 170	94.00

### Protractors

		Order no.	List price
			EUR
		4342 410	14.00



## Calibration service



### Squares with and without base, knife edge squares according to DIN 875 all accuracies

	Max. length	Order no.	List price
	mm		EUR
	100	4340 210	18.20
	200	4340 214	20.00
	500	4340 218	29.50
	750	4340 222	51.00
	1000	4340 226	61.00

### Graduated Rules according to DIN 866 Type A / B

	Max. length	Order no.	List price
	mm		EUR
	500	4350 210	36.50
	1000	4350 218	60.00

### Flat rules according to DIN 874 Part 1 all accuracies

	Max. length	Order no.	List price
	mm		EUR
	500	4351 610	30.50
	1000	4351 618	70.00

### Knife edge rules according to DIN 874 Part 2 all accuracies

	Max. length	Order no.	List price
	mm		EUR
	200	4352 412	17.50
	500	4352 418	27.50
	1000	4352 422	52.00

### Levels

	Max. length	Order no.	List price
	mm		EUR
	300	4353 410	64.00

### Frame levels

	Max. length	Order no.	List price
	mm		EUR
	300	4353 510	88.00

### Plug gauges GO / NOGO

	Max. diameter	Order no.	List price
	mm		EUR
	100	4357 610	13.50
	200	4357 620	23.00



## Calibration service



### Setting rings (master rings)

	Max. diameter mm	Order no.	List price EUR
	100	4358 410	20.00
	200	4358 420	35.50

### Dial test indicator

	Order no.	List price EUR
	4360 810	41.00

### Snap gauges GO and NOGO

	Max. nominal size	Order no.	List price EUR
	100	4358 810	23.00

### Caliper gauges analogue and digital

	Order no.	List price EUR
	4361 410	62.00

### Thread plug gauges GO / NOGO

	Max. diameter mm	Order no.	List price EUR
	100	4359 210	29.00

### Thread master rings

	Max. diameter mm	Order no.	List price EUR
	100	4359 410	37.00



Order no.	Page	List price in €	Order no.	Page	List price in €	Order no.	Page	List price in €
0003219	57	8.70	0234518	30	850.00	0301006	141	47.30
0003220	57	10.40	0234524	30	1787.00	0301007	141	67.00
0003221	57	13.10	0234526	30	2616.00	0302001	141	12.10
0003222	57	18.10	0235503	30	214.00	0302002	141	13.30
0003223	57	20.20	0235508	30	596.00	0302003	141	14.30
0003224	57	30.50	0235514	30	780.00	0302004	141	18.60
0003225	57	39.60	0235518	30	921.00	0302005	141	24.40
0003228	57	53.00	0235524	30	1895.00	0302006	141	68.00
0003229	57	54.00	0236503	31	165.00	0302007	141	84.00
0003230	57	56.00	0236504	32	291.00	0303001	142	8.10
0003231	57	57.00	0236508	31	459.00	0303003	142	10.00
0003237	57	75.00	0236509	32	605.00	0303004	142	10.60
0003241	57	97.00	0236510	32	722.00	0303005	142	12.10
0003242	57	93.00	0236514	31	569.00	0303006	142	14.80
0003247	57	153.00	0236516	32	1121.00	0303007	142	18.40
0003251	57	172.00	0236518	31	709.00	0304001	142	8.10
0003252	57	186.00	0236520	32	1360.00	0304003	142	10.00
0003280	168	4.90	0236525	32	1907.00	0304004	142	10.60
0003281	168	5.30	0236527	32	2825.00	0304005	142	12.10
0003282	168	5.60	0237503	31	197.00	0304006	142	14.80
0003283	168	6.90	0237504	32	319.00	0304007	142	18.40
0003284	168	7.70	0237508	31	516.00	0304008	142	27.80
0003285	168	8.70	0237510	32	779.00	0304009	142	39.90
0003286	168	10.20	0237514	31	640.00	0304010	142	74.00
0003287	168	9.60	0237516	32	1189.00	0306001	141	15.50
0003288	168	21.80	0237518	31	782.00	0306003	141	17.50
0003289	168	13.10	0237520	32	1431.00	0306005	141	27.30
0003290	168	21.80	0237521	32	1931.00	0308201	145	106.00
0003291	168	37.60	0237524	31	1673.00	0308202	145	128.00
0003292	168	41.50	0237525	32	2020.00	0308303	145	156.00
0003293	168	41.90	0237526	31	2535.00	0308305	145	184.00
0003294	168	46.80	0258501	41	163.00	0310102	143	4.60
0180310	14	5.00	0258502	41	217.00	0310103	143	5.00
0180320	14	8.10	0258503	41	333.00	0310105	143	5.60
0180330	14	8.10	0260501	42	84.00	0310107	143	7.20
0182501	13	38.90	0260502	42	84.00	0310108	143	8.40
0184501	8	29.40	0262503	40	306.00	0311101	143	4.90
0184505	8	38.90	026652005	38	408.00	0311102	143	5.70
0184508	8	58.00	0268201	44	348.00	0311103	143	6.70
0185500	8	22.60	0268211	44	424.00	0311105	143	7.90
0185501	8	29.40	0281501	45	101.00	0311107	143	9.60
018550105	8	29.40	0281501	45	101.00	0311108	143	10.30
0185505	8	38.90	0281502	45	104.00	0311120	143	2.60
018550505	8	38.90	0281505	45	130.00	0311121	143	21.60
0185508	8	58.00	0282501	46	88.00	0312101	144	3.90
0188501	9	26.00	0282502	46	93.00	0312103	144	5.60
0189501	9	26.00	0282503	46	105.00	0312105	144	6.70
0190501	12	30.50	0282505	46	112.00	0312107	144	8.30
0194501	9	30.50	0282507	46	172.00	0312108	144	10.00
0195501	9	30.50	0282508	46	262.00	0313101	144	3.90
019650105	10	28.30	0282509	46	437.00	0313103	144	5.60
019650116	10	28.30	0282510	46	618.00	0313105	144	6.70
019650516	10	40.50	0286501	47	105.00	0313107	144	8.30
0197501	11	37.20	0286502	47	106.00	0313108	144	10.00
0197505	11	85.00	0286505	47	130.00	0321301	147	25.60
0197508	11	168.00	0286507	47	208.00	0321302	147	28.70
0198501	11	34.40	0292501	47	100.00	0321303	147	29.20
0199501	11	34.40	0292502	47	113.00	0321305	147	56.00
0203501	12	59.00	0300007	140	2.40	0322501	145	29.20
0212520	16	150.00	0300008	140	2.60	0322503	145	45.80
0217501	15	76.00	0300011	140	2.40	0322510	145	5.20
0217502	15	153.00	0300102	140	6.40	0323308	147	19.10
0218501	15	102.00	0300112	140	5.30	0323318	147	24.40
0220705	20	25.30	0300114	140	10.00	0334101	151	85.00
0230503	33	201.00	0300120	140	14.50	0334102	151	140.00
0230508	33	575.00	0300130	140	3.90	0344501	146	147.00
0231503	33	232.00	0301001	141	8.30	0344502	146	188.00
0231508	33	628.00	0301002	141	9.40	0344503	146	237.00
0234503	30	185.00	0301003	141	10.40	0345522	148	439.00
0234508	30	552.00	0301004	141	14.50	0345530	148	549.00
0234514	30	708.00	0301005	141	17.50	0345910	148	140.00





Order no.	Page	List price in €
0345912	148	156.00
0349910	151	129.00
0349912	151	150.00
0349914	151	167.00
0349916	151	191.00
0350722	149	634.00
0350730	149	792.00
0350734	149	1097.00
0350910	149	88.50
0352722	150	840.00
0352730	150	970.00
0352734	150	1190.00
0368102	154	28.50
0368103	154	31.80
0368104	154	42.70
0368105	154	55.00
0368106	154	73.00
0368107	154	90.00
0368108	154	195.00
0368109	154	287.00
0368110	154	405.00
0368111	154	810.00
0368112	154	1362.00
0368202	154	55.00
0368203	154	65.00
0368204	154	88.00
0368205	154	119.00
0368206	154	166.00
0368207	154	214.00
0368208	154	331.00
0368209	154	457.00
0368210	154	679.00
0368211	154	1166.00
0368212	154	2472.00
0369102	154	19.80
0369103	154	21.40
0369104	154	26.10
0369105	154	36.10
0369106	154	48.80
0369107	154	68.00
0369108	154	137.00
0369109	154	179.00
0369110	154	286.00
0369111	154	530.00
0369112	154	945.00
0369202	154	36.60
0369203	154	44.30
0369204	154	55.00
0369205	154	84.00
0369206	154	110.00
0369207	154	135.00
0369208	154	228.00
0369209	154	318.00
0369210	154	534.00
0369211	154	995.00
0369212	154	1866.00
0370102	156	17.60
0370103	156	19.80
0370104	156	26.50
0370105	156	33.70
0370106	156	45.10
0370107	156	57.00
0370108	156	112.00
0370109	156	164.00
0370110	156	232.00
0370111	156	463.00
0370112	156	778.00
0370202	156	19.40
0370203	156	21.70
0370204	156	32.70
0370205	156	42.90

Order no.	Page	List price in €
0370206	156	59.00
0370207	156	78.00
0370208	156	198.00
0370209	156	254.00
0370210	156	395.00
0370211	156	611.00
0370212	156	988.00
0371102	156	12.60
0371103	156	13.90
0371104	156	17.00
0371105	156	21.90
0371106	156	30.50
0371107	156	38.90
0371108	156	93.00
0371109	156	121.00
0371110	156	168.00
0371111	156	316.00
0371112	156	541.00
0371202	156	13.80
0371203	156	15.30
0371204	156	18.60
0371205	156	27.90
0371206	156	37.80
0371207	156	47.40
0371208	156	156.00
0371209	156	198.00
0371210	156	304.00
0371211	156	556.00
0371212	156	896.00
0372102	157	14.10
0372103	157	15.80
0372104	157	21.20
0372105	157	27.00
0372106	157	36.10
0372107	157	44.90
0372108	157	67.00
0372109	157	82.00
0372110	157	108.00
0372111	157	136.00
0372112	157	198.00
0372113	157	867.00
0372114	157	1071.00
0373102	157	10.10
0373103	157	11.10
0373104	157	13.60
0373105	157	17.50
0373106	157	22.50
0373107	157	30.30
0373108	157	47.90
0373109	157	67.00
0373110	157	86.00
0373111	157	106.00
0373112	157	164.00
0373113	157	788.00
0373114	157	947.00
0374404	158	11.90
0374408	158	13.30
0374410	158	16.10
0374412	158	19.40
0374414	158	23.70
0374416	158	29.90
0374418	158	39.70
0374420	158	54.00
0374424	158	64.00
0374428	158	96.00
0374430	158	225.00
0374432	158	330.00
0375404	158	8.70
0375408	158	9.20
0375410	158	9.70
0375412	158	11.90

Order no.	Page	List price in €
0375414	158	13.00
0375416	158	17.90
0375418	158	19.80
0375420	158	24.30
0375424	158	28.80
0375428	158	37.20
0375430	158	109.00
0375432	158	164.00
0376102	159	13.90
0376103	159	14.80
0376104	159	18.60
0376105	159	30.60
0376112	159	13.00
0376113	159	13.80
0376114	159	16.70
0376115	159	23.40
0376116	159	28.90
0376117	159	34.40
0380103	163	65.00
0380104	163	77.00
0380105	163	96.00
0380106	163	106.00
0380107	163	115.00
0380108	163	296.00
0380109	163	526.00
0385102	155	28.60
0385103	155	30.50
0385104	155	36.50
0385105	155	55.00
0385106	155	76.00
0385108	155	132.00
0385202	155	39.60
0385203	155	44.00
0385204	155	55.00
0385205	155	73.00
0385206	155	93.00
0385208	155	137.00
0386102	155	21.60
0386103	155	23.20
0386104	155	28.30
0386105	155	35.10
0386106	155	45.20
0386108	155	87.00
0386202	155	27.30
0386203	155	30.90
0386204	155	36.50
0386205	155	47.30
0386206	155	61.00
0386208	155	121.00
0387200	162	20.20
0387201	162	20.20
0388102	161	22.80
0388103	161	27.10
0388104	161	32.40
0388105	161	43.60
0388106	161	61.00
0388108	161	106.00
0388202	161	27.10
0388203	161	31.80
0388204	161	38.40
0388205	161	49.50
0388206	161	74.00
0388208	161	161.00
0388210	161	762.00
0390102	160	40.80
0390103	160	40.80
0390104	160	47.30
0390105	160	60.00
0390106	160	82.00
0390108	160	137.00
0390202	160	54.00



Order no.	Page	List price in €	Order no.	Page	List price in €	Order no.	Page	List price in €
0390203	160	61.00	0411306	169	147.00	0455444	180	255.00
0390204	160	78.00	0411307	169	159.00	0458102	179	43.20
0390205	160	101.00	0411308	169	166.00	0458103	179	52.00
0390206	160	126.00	0411309	169	175.00	0458104	179	67.00
0390208	160	193.00	0411310	169	216.00	0458105	179	81.00
0391102	160	64.00	0412201	169	39.90	0458106	179	96.00
0391103	160	64.00	0412202	169	43.20	0458107	179	111.00
0391104	160	83.00	0412203	169	44.50	0458108	179	273.00
0391105	160	104.00	0412204	169	62.00	0458109	179	292.00
0391106	160	140.00	0413301	170	27.00	0458110	179	376.00
0391108	160	204.00	0413302	170	28.10	0458111	179	576.00
0391202	160	76.00	0415301	170	74.00	0458112	179	588.00
0391203	160	85.00	0415302	170	114.00	0458113	179	599.00
0391204	160	96.00	0415303	170	155.00	0458202	179	77.00
0391205	160	123.00	0415304	170	212.00	0458203	179	97.00
0391206	160	158.00	0415305	170	241.00	0458204	179	119.00
0391208	160	256.00	0416301	171	147.00	0458205	179	157.00
0394101	161	239.00	0416302	171	192.00	0458206	179	190.00
0394104	161	43.20	0416303	171	248.00	0460201	176	1.30
0395102	165	31.60	0416304	171	411.00	0460202	176	1.30
0395103	165	35.10	0416305	171	476.00	0460204	176	1.90
0395104	165	47.30	0420121	173	18.40	0460205	176	4.90
0395106	165	22.30	0420206	173	20.80	0460206	176	10.40
0395107	165	24.40	0420207	173	21.80	0460207	176	3.70
0395108	165	35.10	0420208	173	22.00	0460208	176	8.70
0395122	165	29.90	0420522	173	89.00	0460209	176	18.10
0395123	165	34.20	0425701	172	1486.00	0460210	176	29.10
0395124	165	45.80	0425702	172	1501.00	0460211	176	35.10
0395126	165	21.50	0425703	172	1513.00	0460212	176	82.00
0395127	165	23.90	0451101	178	29.10	0460213	176	126.00
0395128	165	33.60	0451102	178	67.00	0460221	176	1.30
0395132	164	9.70	0451103	178	120.00	0460222	176	1.30
0395133	164	12.40	0451104	178	166.00	0460223	176	1.90
0395134	164	15.00	0451105	178	343.00	0460224	176	1.90
0395136	164	9.70	0451106	178	623.00	0460225	176	4.90
0395137	164	12.40	0451201	178	52.00	0460226	176	10.40
0395138	164	15.00	0451202	178	119.00	0460227	176	3.70
0395142	164	21.60	0451203	178	176.00	0460228	176	8.70
0395143	164	24.40	0451204	178	309.00	0460229	176	18.10
0395144	164	31.80	0451205	178	623.00	0460230	176	29.10
0395146	164	15.90	0451206	178	1125.00	0460231	176	35.10
0395147	164	21.60	0452101	178	22.90	0460232	176	82.00
0395148	164	29.10	0452103	178	45.20	0460233	176	126.00
0396290	166	109.00	0452104	178	66.00	0460241	176	1.30
0396414	163	18.60	0452105	178	108.00	0460242	176	1.30
0396416	163	22.00	0452106	178	170.00	0460243	176	1.90
0396418	163	26.00	0452107	178	188.00	0460244	176	1.90
0396420	163	32.70	0452108	178	358.00	0460245	176	4.90
0396426	163	39.50	0452109	178	643.00	0460246	176	10.40
0396432	167	11.10	0452201	178	30.60	0460247	176	3.70
0396433	167	13.70	0452203	178	67.00	0460248	176	8.70
0396434	167	16.70	0452204	178	114.00	0460249	176	18.10
0396435	167	21.50	0452205	178	181.00	0460250	176	29.10
0396436	167	23.90	0452206	178	345.00	0460251	176	35.10
0396443	166	11.90	0452207	178	359.00	0460252	176	82.00
0396444	166	14.00	0452208	178	645.00	0460501	177	3.10
0396445	166	15.20	0452209	178	1229.00	0460502	177	4.90
0396446	166	19.50	0453422	177	10.10	0460504	177	5.60
0396453	166	14.90	0453430	177	14.90	0460505	177	12.10
0396454	166	16.80	0453434	177	22.00	0460506	177	24.60
0396455	166	18.80	0454424	180	10.60	0460507	177	6.40
0396456	166	22.90	0454428	180	13.20	0460508	177	13.30
0396982	167	13.50	0454434	180	26.20	0460509	177	27.80
0396983	167	15.90	0454438	180	47.60	0460510	177	82.00
0396984	167	19.00	0454440	180	73.00	0460511	177	128.00
0397101	162	208.00	0454444	180	191.00	0460521	177	3.10
0411301	169	28.30	0455424	180	19.50	0460522	177	4.90
0411302	169	36.50	0455428	180	24.40	0460524	177	5.60
0411303	169	40.50	0455434	180	46.30	0460525	177	12.10
0411304	169	59.00	0455438	180	83.00	0460526	177	24.60
0411305	169	117.00	0455440	180	121.00	0460527	177	6.40



Order no.	Page	List price in €	Order no.	Page	List price in €	Order no.	Page	List price in €
0460528	177	13.30	0512205	183	24.40	0581125	192	10.40
0460529	177	27.80	0512206	183	53.00	0582110	192	75.00
0464101	181	75.00	0512207	183	96.00	0582120	193	75.00
0464102	181	106.00	0512208	183	131.00	0582130	193	75.00
0464103	181	166.00	0512209	183	253.00	0584101	204	358.00
0464104	181	280.00	0512210	183	512.00	0589101	193	19.10
0464105	181	502.00	0512211	183	671.00	0589103	193	59.00
0464106	181	853.00	0512601	183	6.10	0595101	194	23.90
0464107	181	1309.00	0512602	183	6.10	0595110	193	14.90
0464108	181	2249.00	0512603	183	6.10	0595115	194	4.30
0464201	182	118.00	0512604	183	7.40	0595130	191	3.50
0464202	182	161.00	0512605	183	8.60	0595140	191	3.10
0464203	182	303.00	0512606	183	9.70	0595142	191	3.10
0464204	182	502.00	0512607	183	12.20	0595251	194	103.00
0464205	182	928.00	0512608	183	18.40	0597301	43	198.00
0464206	182	1615.00	0512609	183	18.40	0597301	195	198.00
0464207	182	2856.00	0512610	183	36.70	0597305	43	198.00
0464208	182	5095.00	0512611	183	42.80	0597305	195	198.00
0465101	181	36.50	0520101	185	150.00	0598103	196	55.00
0465102	181	60.00	0520102	185	198.00	0598105	196	55.00
0465103	181	82.00	0520103	185	262.00	0598601	196	55.00
0465104	181	149.00	0520104	185	366.00	0598601	196	55.00
0465105	181	303.00	0520105	185	500.00	0599102	196	67.00
0465106	181	566.00	0522101	186	230.00	0599151	196	8.10
0465107	181	972.00	0522102	186	281.00	0599152	196	8.10
0465108	181	1570.00	0522103	186	405.00	0600101	195	29.10
0465201	182	67.00	0522111	187	36.10	0601103	197	103.00
0465202	182	103.00	0522112	187	41.70	0604002	197	7.70
0465203	182	185.00	0522113	187	51.00	0604004	197	8.50
0465204	182	289.00	0522201	186	150.00	0604006	197	8.50
0465205	182	681.00	0522202	186	183.00	0604202	197	10.20
0465206	182	1037.00	0522203	186	263.00	0604204	197	12.60
0465207	182	1998.00	0522206	186	286.00	0604206	197	12.60
0465208	182	2942.00	0522207	186	348.00	0605101	198	2.90
0466101	181	25.10	0522208	186	500.00	0605102	198	2.60
0466102	181	44.00	0524101	187	254.00	0605103	198	2.60
0466103	181	51.00	0524102	187	314.00	0605104	198	2.60
0466104	181	96.00	0524103	187	472.00	0605105	198	3.90
0466105	181	131.00	0525101	188	136.00	0605106	198	4.10
0466106	181	289.00	0525102	188	145.00	0605108	198	3.40
0466107	181	451.00	0525103	188	155.00	0605109	198	3.70
0466108	181	1072.00	0536202	188	494.00	0605110	198	3.40
0466201	182	43.20	0536220	188	117.00	0605111	198	3.40
0466202	182	76.00	0536230	188	159.00	0605112	198	3.90
0466203	182	111.00	0550021	189	318.00	0606121	198	1.90
0466204	182	230.00	0550022	189	349.00	0606123	198	1.90
0466205	182	388.00	0550023	189	380.00	0606127	198	1.90
0466206	182	645.00	0550024	189	412.00	0606130	198	2.90
0466207	182	921.00	0550101	189	225.00	0606132	198	3.40
0466208	182	1715.00	0550102	189	256.00	0606133	198	6.40
0504012	184	105.00	0550103	189	288.00	0606136	198	5.80
0504013	184	164.00	0550104	189	318.00	0606150	199	3.90
0504014	184	252.00	0550131	189	175.00	0606152	199	4.70
0504112	184	75.00	0550132	189	206.00	0606154	199	6.70
0504113	184	100.00	0550133	189	236.00	0606160	199	10.10
0504114	184	164.00	0550134	189	268.00	0606162	199	11.50
0504312	184	52.00	0556022	189	611.00	0606170	199	12.10
0504313	184	76.00	0556023	189	698.00	0606172	199	15.30
0504314	184	124.00	0556024	189	983.00	0606176	199	20.20
0512101	183	11.90	0556101	189	375.00	0606178	199	29.60
0512102	183	13.30	0556102	189	437.00	0607201	198	4.40
0512103	183	15.00	0556103	189	547.00	0607202	198	6.90
0512104	183	17.10	0556104	189	872.00	0607203	198	10.00
0512105	183	22.30	0563001	190	470.00	0607401	198	7.50
0512106	183	41.90	0580101	190	8.40	0607402	198	9.20
0512107	183	75.00	0580111	190	12.10	0607403	198	13.10
0512108	183	118.00	0580121	191	8.50	0608140	199	2.20
0512201	183	15.50	0581101	192	24.40	0608143	199	5.20
0512202	183	18.10	0581103	192	16.50	0608144	199	8.20
0512203	183	18.90	0581105	192	22.60	0608149	199	18.80
0512204	183	21.10	0581123	192	11.90	0611180	201	261.00



Order no.	Page	List price in €	Order no.	Page	List price in €	Order no.	Page	List price in €
0611190	201	283.00	0613207	203	111.00	0613658	202	36.50
0611195	200	3.40	0613209	203	60.00	0613660	202	36.50
0611197	200	44.00	0613214	203	41.90	0613709	202	58.00
0611198	200	67.00	0613216	203	41.90	0613718	202	34.50
0611300	201	90.00	0613218	203	41.90	0613730	202	32.40
0611501	201	51.00	0613220	203	28.60	0613734	202	32.40
0611502	201	38.90	0613222	203	28.60	0613738	202	40.80
0611503	201	14.70	0613226	203	28.60	0613742	202	40.80
0611504	201	14.70	0613228	203	28.60	0613746	202	46.00
0611505	201	12.40	0613230	203	29.70	0613750	202	53.00
0611506	201	10.80	0613232	203	29.70	0613752	202	64.00
0611507	201	10.80	0613234	203	29.70	0613754	202	64.00
0611508	201	10.80	0613236	203	29.70	0613756	202	77.00
0611509	201	10.80	0613238	203	29.70	0613758	202	77.00
0611510	201	10.80	0613240	203	29.70	0613760	202	85.00
0611512	201	10.80	0613242	203	29.70	0613812	202	64.00
0611515	201	10.80	0613244	203	32.40	0613818	202	52.00
0611518	201	10.80	0613246	203	32.40	0613824	202	52.00
0611520	201	10.80	0613248	203	32.40	0613830	202	48.60
0611525	201	10.80	0613250	203	32.40	0613834	202	48.60
0611530	201	10.80	0613252	203	53.00	0613838	202	61.00
0611535	201	12.40	0613254	203	53.00	0613840	202	61.00
0611540	201	12.40	0613256	203	53.00	0613842	202	61.00
0611545	201	12.40	0613258	203	53.00	0613846	202	72.00
0611550	201	12.40	0613260	203	53.00	0613850	202	83.00
0611552	201	18.60	0613309	203	106.00	0613860	202	133.00
0611554	201	18.60	0613318	203	64.00	0623100	205	47.60
0611556	201	18.60	0613330	203	60.00	0623102	205	40.30
0611558	201	18.60	0613334	203	60.00	0623170	205	40.30
0611560	201	18.60	0613338	203	77.00	0623220	205	40.30
0611562	201	18.60	0613342	203	77.00	0623270	205	40.30
0611564	201	18.60	0613346	203	87.00	0623320	205	40.30
0611566	201	19.80	0613350	203	100.00	0623370	205	40.30
0611568	201	19.80	0613352	203	119.00	0623375	205	40.30
0611570	201	19.80	0613354	203	119.00	0623380	205	40.30
0612180	200	285.00	0613356	203	143.00	0623385	205	40.30
0612501	200	51.00	0613358	203	143.00	0623390	205	40.30
0612502	200	38.90	0613360	203	163.00	0623395	205	40.30
0612503	200	17.00	0613412	203	121.00	0623400	205	42.80
0612504	200	17.00	0613418	203	97.00	0623405	205	42.80
0612505	200	14.70	0613424	203	97.00	0623410	205	42.80
0612506	200	12.40	0613430	203	93.00	0623415	205	42.80
0612507	200	12.40	0613434	203	93.00	0623420	205	42.80
0612508	200	12.40	0613438	203	117.00	0623425	205	42.80
0612509	200	12.40	0613440	203	117.00	0623430	205	42.80
0612510	200	12.40	0613442	203	117.00	0623435	205	42.80
0612512	200	12.40	0613446	203	129.00	0623440	205	42.80
0612515	200	12.40	0613450	203	150.00	0623445	205	42.80
0612518	200	12.40	0613607	202	77.00	0623450	205	42.80
0612520	200	12.40	0613609	202	41.40	0623455	205	42.80
0612525	200	12.40	0613614	202	29.10	0623460	205	42.80
0613107	203	77.00	0613616	202	29.10	0623465	205	42.80
0613109	203	41.40	0613618	202	29.10	0623470	205	42.80
0613114	203	29.10	0613620	202	19.90	0623475	205	52.00
0613116	203	29.10	0613622	202	19.90	0623500	205	52.00
0613118	203	29.10	0613626	202	19.90	0623510	205	52.00
0613120	203	19.90	0613628	202	19.90	0623520	205	52.00
0613122	203	19.90	0613630	202	20.60	0623530	205	52.00
0613126	203	19.90	0613632	202	20.60	0623540	205	52.00
0613128	203	19.90	0613634	202	20.60	0623550	205	52.00
0613130	203	20.60	0613636	202	20.60	0623560	205	52.00
0613134	203	20.60	0613638	202	20.60	0623570	205	52.00
0613138	203	20.60	0613640	202	20.60	0623580	205	52.00
0613142	203	20.60	0613642	202	20.60	0623590	205	52.00
0613146	203	22.80	0613644	202	22.80	0623600	205	52.00
0613150	203	22.80	0613646	202	22.80	0623610	205	52.00
0613152	203	36.50	0613648	202	22.80	0623620	205	52.00
0613154	203	36.50	0613650	202	22.80	0623630	205	52.00
0613156	203	36.50	0613652	202	36.50	0623640	205	52.00
0613158	203	36.50	0613654	202	36.50	0623650	205	61.00
0613160	203	36.50	0613656	202	36.50	0623670	205	61.00



Order no.	Page	List price in €	Order no.	Page	List price in €	Order no.	Page	List price in €
0623680	205	61.00	0624360	206	27.00	0625150	207	22.00
0623690	205	61.00	0624365	206	27.00	0625155	207	22.00
0623700	205	61.00	0624370	206	27.00	0625160	207	22.00
0623710	205	76.00	0624375	206	27.00	0625165	207	22.00
0623720	205	76.00	0624380	206	27.00	0625170	207	22.00
0623730	205	91.00	0624385	206	27.00	0625175	207	22.00
0623740	205	319.00	0624390	206	27.00	0625180	207	22.00
0623750	205	319.00	0624395	206	27.00	0625185	207	22.00
0623760	205	319.00	0624400	206	28.10	0625190	207	22.00
0623770	205	381.00	0624405	206	28.10	0625195	207	22.00
0623780	205	544.00	0624410	206	28.10	0625200	207	22.00
0623790	205	706.00	0624415	206	28.10	0625205	207	22.00
0623800	205	976.00	0624420	206	28.10	0625210	207	22.00
0624100	206	31.70	0624425	206	28.10	0625215	207	22.00
0624102	206	27.00	0624430	206	28.10	0625220	207	22.00
0624104	206	27.00	0624435	206	28.10	0625225	207	22.00
0624106	206	27.00	0624440	206	28.10	0625230	207	22.00
0624108	206	27.00	0624445	206	28.10	0625235	207	22.00
0624110	206	27.00	0624450	206	28.10	0625240	207	22.00
0624112	206	27.00	0624455	206	28.10	0625245	207	22.00
0624114	206	27.00	0624460	206	28.10	0625250	207	22.00
0624116	206	27.00	0624465	206	28.10	0625255	207	22.00
0624118	206	27.00	0624470	206	28.10	0625260	207	22.00
0624120	206	27.00	0624475	206	34.20	0625265	207	22.00
0624122	206	27.00	0624500	206	34.20	0625270	207	22.00
0624130	206	27.00	0624510	206	34.20	0625275	207	22.00
0624135	206	27.00	0624520	206	34.20	0625280	207	22.00
0624140	206	27.00	0624530	206	34.20	0625285	207	22.00
0624145	206	27.00	0624540	206	34.20	0625290	207	22.00
0624150	206	27.00	0624550	206	34.20	0625295	207	22.00
0624155	206	27.00	0624560	206	34.20	0625300	207	22.00
0624160	206	27.00	0624570	206	34.20	0625305	207	22.00
0624165	206	27.00	0624580	206	34.20	0625310	207	22.00
0624170	206	27.00	0624590	206	34.20	0625315	207	22.00
0624175	206	27.00	0624600	206	34.20	0625320	207	22.00
0624180	206	27.00	0624610	206	34.20	0625325	207	22.00
0624185	206	27.00	0624620	206	34.20	0625330	207	22.00
0624190	206	27.00	0624630	206	34.20	0625335	207	22.00
0624195	206	27.00	0624640	206	34.20	0625340	207	22.00
0624200	206	27.00	0624650	206	40.30	0625345	207	22.00
0624205	206	27.00	0624660	206	40.30	0625350	207	22.00
0624210	206	27.00	0624670	206	40.30	0625355	207	22.00
0624215	206	27.00	0624680	206	40.30	0625360	207	22.00
0624220	206	27.00	0624690	206	40.30	0625365	207	22.00
0624225	206	27.00	0624700	206	40.30	0625370	207	22.00
0624230	206	27.00	0624710	206	51.00	0625375	207	22.00
0624235	206	27.00	0624720	206	51.00	0625380	207	22.00
0624240	206	27.00	0624730	206	60.00	0625385	207	22.00
0624245	206	27.00	0624740	206	194.00	0625390	207	22.00
0624250	206	27.00	0624750	206	194.00	0625395	207	22.00
0624255	206	27.00	0624760	206	194.00	0625400	207	22.00
0624260	206	27.00	0624770	206	230.00	0625405	207	22.00
0624265	206	27.00	0624780	206	331.00	0625410	207	22.00
0624270	206	27.00	0624790	206	428.00	0625415	207	22.00
0624275	206	27.00	0624800	206	592.00	0625420	207	22.00
0624280	206	27.00	0625100	207	25.60	0625425	207	22.00
0624285	206	27.00	0625102	207	22.00	0625430	207	22.00
0624290	206	27.00	0625104	207	22.00	0625435	207	22.00
0624295	206	27.00	0625106	207	22.00	0625440	207	22.00
0624300	206	27.00	0625108	207	22.00	0625445	207	22.00
0624305	206	27.00	0625110	207	22.00	0625450	207	22.00
0624310	206	27.00	0625112	207	22.00	0625455	207	22.00
0624315	206	27.00	0625114	207	22.00	0625460	207	22.00
0624320	206	27.00	0625116	207	22.00	0625465	207	22.00
0624325	206	27.00	0625118	207	22.00	0625470	207	22.00
0624330	206	27.00	0625120	207	22.00	0625475	207	27.00
0624335	206	27.00	0625122	207	22.00	0625500	207	27.00
0624340	206	27.00	0625130	207	22.00	0625510	207	27.00
0624345	206	27.00	0625135	207	22.00	0625520	207	27.00
0624350	206	27.00	0625140	207	22.00	0625530	207	27.00
0624355	206	27.00	0625145	207	22.00	0625540	207	27.00



Order no.	Page	List price in €	Order no.	Page	List price in €	Order no.	Page	List price in €
0625550	207	27.00	0636301	213	916.00	0637139	216	45.20
0625560	207	27.00	0636321	213	278.00	0637140	216	46.40
0625570	207	27.00	0636322	213	278.00	0637141	216	47.30
0625580	207	27.00	0636323	213	343.00	0637142	216	48.60
0625590	207	27.00	0636324	213	343.00	0637144	216	51.00
0625600	207	27.00	0636325	213	343.00	0637146	216	52.00
0625610	207	27.00	0636326	213	419.00	0637147	216	64.00
0625620	207	27.00	0636327	213	419.00	0637148	216	56.00
0625630	207	27.00	0636328	213	419.00	0637149	216	57.00
0625640	207	27.00	0636329	213	419.00	0637150	216	58.00
0625650	207	31.70	0636341	213	1166.00	0637151	216	60.00
0625660	207	31.70	0636342	213	1166.00	0637152	216	61.00
0625670	207	31.70	0636343	213	1477.00	0637154	216	64.00
0625680	207	31.70	0636344	213	1477.00	0637155	216	67.00
0625690	207	31.70	0636345	213	1477.00	0637156	216	72.00
0625700	207	31.70	0636346	213	1817.00	0637157	216	76.00
0625710	207	40.30	0636347	213	1817.00	0637158	216	78.00
0625720	207	40.30	0636348	213	1817.00	0637159	216	83.00
0625730	207	47.60	0636349	213	1817.00	0637160	216	83.00
0625740	207	156.00	0636351	213	1489.00	0637161	216	91.00
0625750	207	156.00	0636352	213	1353.00	0637162	216	92.00
0625760	207	156.00	0636372	213	815.00	0637163	216	94.00
0625770	207	166.00	0636373	213	815.00	0637164	216	100.00
0625780	207	262.00	0636374	213	1073.00	0637165	216	104.00
0625790	207	308.00	0636375	213	1073.00	0637166	216	105.00
0625800	207	403.00	0636376	213	1073.00	0637167	216	108.00
0633001	209	354.00	0636377	213	1300.00	0637168	216	112.00
0633014	210	1002.00	0636378	213	1475.00	0637169	216	118.00
0633016	210	916.00	0636379	213	1475.00	0637170	216	119.00
0633018	210	596.00	0636380	213	1475.00	0637171	216	122.00
0633020	210	436.00	0636392	212	14.90	0637172	216	124.00
0633114	210	771.00	0636393	212	17.10	0637173	216	129.00
0633116	210	588.00	0636394	212	32.40	0637174	216	131.00
0633118	210	363.00	0636395	212	41.50	0637190	217	167.00
0633120	210	264.00	0636396	212	47.80	0649201	214	82.00
0633136	208	206.00	0637103	216	35.10	0649202	214	82.00
0633137	208	235.00	0637104	216	35.10	0649203	214	82.00
0633138	208	282.00	0637105	216	35.10	0649204	214	84.00
0633139	208	259.00	0637106	216	25.50	0649205	214	84.00
0633140	208	306.00	0637107	216	25.50	0649206	214	88.00
0633141	208	353.00	0637108	216	22.80	0649207	214	88.00
0633142	208	399.00	0637109	216	22.80	0649208	214	92.00
0633143	208	436.00	0637110	216	22.80	0649209	214	92.00
0633144	208	505.00	0637111	216	21.60	0649210	214	96.00
0633145	208	705.00	0637112	216	21.60	0649211	214	96.00
0633150	208	242.00	0637113	216	22.80	0649212	214	105.00
0633151	208	242.00	0637114	216	22.80	0649213	214	105.00
0633152	208	259.00	0637115	216	24.40	0649215	214	117.00
0633153	208	317.00	0637116	216	25.50	0649216	214	133.00
0633154	208	447.00	0637117	216	25.50	0649217	214	133.00
0633155	208	582.00	0637118	216	27.10	0649219	214	159.00
0633174	208	235.00	0637119	216	28.30	0649220	214	207.00
0633175	208	277.00	0637120	216	28.30	0649222	214	237.00
0633176	208	436.00	0637121	216	29.10	0649223	214	237.00
0633177	208	517.00	0637122	216	29.10	0656303	215	57.00
0633182	208	183.00	0637123	216	30.50	0656304	215	85.00
0633214	211	487.00	0637124	216	31.60	0656305	215	1007.00
0633216	211	385.00	0637125	216	31.60	0656306	215	1108.00
0633218	211	263.00	0637126	216	31.60	0656309	215	65.00
0633220	211	174.00	0637127	216	33.30	0656310	215	57.00
0633805	209	383.00	0637128	216	34.00	0656311	215	57.00
0633808	209	511.00	0637129	216	35.10	0656312	215	57.00
0633810	209	310.00	0637130	216	35.10	0656313	215	56.00
0633833	56	635.00	0637131	216	36.50	0656314	215	54.00
0633833	209	635.00	0637132	216	37.90	0656315	215	54.00
0633834	56	847.00	0637133	216	37.90	0656316	215	54.00
0633834	209	847.00	0637134	216	39.00	0656317	215	54.00
0633836	56	1512.00	0637135	216	39.00	0656318	215	54.00
0633836	209	1512.00	0637136	216	43.20	0656319	215	56.00
0633838	56	2673.00	0637137	216	44.00	0656320	215	57.00
0633838	209	2673.00	0637138	216	45.20	0656321	215	58.00



Order no.	Page	List price in €	Order no.	Page	List price in €	Order no.	Page	List price in €
0656322	215	58.00	0656393	215	803.00	0710112	107	5.10
0656323	215	59.00	0656394	215	838.00	0710113	107	5.10
0656324	215	59.00	0656395	215	877.00	0710114	107	5.10
0656325	215	60.00	0656396	215	917.00	0710115	107	5.10
0656326	215	60.00	0656397	215	956.00	0710116	107	5.10
0656327	215	61.00	0656398	215	996.00	0710117	107	5.10
0656328	215	64.00	0656399	215	1033.00	0710118	107	5.10
0656329	215	64.00	0658009	218	77.00	0710119	107	5.10
0656330	215	64.00	0658011	218	73.00	0710120	107	5.10
0656331	215	67.00	0658012	218	72.00	0710121	107	5.10
0656332	215	68.00	0658013	218	68.00	0710122	107	5.10
0656333	215	69.00	0658015	218	72.00	0710123	107	5.10
0656334	215	72.00	0658017	218	76.00	0710124	107	5.10
0656335	215	72.00	0658019	218	82.00	0710125	107	5.10
0656336	215	73.00	0658090	218	285.00	0710126	107	5.10
0656337	215	67.00	0658509	218	60.00	0710127	107	5.10
0656338	215	76.00	0658511	218	56.00	0710128	107	5.10
0656339	215	76.00	0658512	218	56.00	0710129	107	5.10
0656340	215	77.00	0658513	218	56.00	0710161	23	4.90
0656341	215	77.00	0658515	218	57.00	0710161	108	4.90
0656342	215	78.00	0658517	218	67.00	0710162	108	6.40
0656343	215	81.00	0658519	218	78.00	0710163	23	7.40
0656344	215	82.00	0658590	219	285.00	0710163	108	7.40
0656345	215	83.00	0658609	219	60.00	0710164	108	7.40
0656346	215	87.00	0658611	219	56.00	0710165	108	9.30
0656347	215	92.00	0658612	219	56.00	0710166	23	6.70
0656348	215	94.00	0658613	219	56.00	0710166	109	6.70
0656349	215	96.00	0658615	219	57.00	0710167	23	4.70
0656350	215	100.00	0658617	219	67.00	0710167	109	4.70
0656351	215	102.00	0658619	219	78.00	0710168	109	4.70
0656352	215	105.00	0658690	219	285.00	0710169	109	9.30
0656353	215	108.00	0700100	103	76.00	0710170	109	9.30
0656354	215	118.00	0700101	103	76.00	0710171	109	9.30
0656355	215	122.00	0700102	103	58.00	0710172	109	9.30
0656356	215	128.00	0700104	103	67.00	0710173	109	9.30
0656357	215	131.00	0701101	100	51.00	0710174	109	9.30
0656358	215	139.00	0701102	100	64.00	0710175	109	9.30
0656359	215	149.00	0701103	101	27.10	0710176	109	9.30
0656360	215	155.00	0701106	101	28.20	0710177	23	9.30
0656361	215	161.00	0701110	101	47.00	0710177	109	9.30
0656362	215	165.00	0701111	101	54.00	0710178	109	9.30
0656363	215	174.00	0702106	103	77.00	0710179	109	9.30
0656364	215	180.00	0703101	101	124.00	0710180	109	9.30
0656365	215	190.00	0703104	101	173.00	0710181	110	9.30
0656366	215	202.00	0703107	101	346.00	0710182	110	9.30
0656367	215	216.00	0704105	102	88.00	0710183	110	9.30
0656368	215	223.00	0704106	102	109.00	0710184	110	9.30
0656369	215	232.00	0704109	102	143.00	0710185	110	9.30
0656370	215	247.00	0704110	102	184.00	0710186	110	9.30
0656371	215	259.00	0705102	104	137.00	0710187	110	9.30
0656372	215	268.00	0705104	104	137.00	0710188	110	9.30
0656373	215	280.00	0705105	104	143.00	0710189	110	9.30
0656374	215	295.00	0705107	104	145.00	0710192	110	11.40
0656375	215	307.00	0705109	104	176.00	0710193	110	4.90
0656376	215	321.00	0706102	104	88.00	0710194	110	6.70
0656377	215	335.00	0707101	102	156.00	0710195	111	1.70
0656378	215	346.00	0707102	102	133.00	0710196	111	12.60
0656379	215	361.00	0708101	100	109.00	0710197	111	1.50
0656380	215	374.00	0708102	100	69.00	0710261	108	33.60
0656381	215	387.00	0708103	100	84.00	0710262	108	55.00
0656382	215	401.00	0708104	100	57.00	0710263	108	85.00
0656383	215	438.00	0708105	100	69.00	0710264	108	64.00
0656384	215	473.00	0708106	100	92.00	0710265	108	29.10
0656385	215	508.00	0709101	105	131.00	0710267	109	15.50
0656386	215	545.00	0709108	105	156.00	0710268	109	15.50
0656387	215	582.00	0710101	106	60.00	0710292	110	81.00
0656388	215	617.00	0710102	106	7.50	0710297	111	6.50
0656389	215	654.00	0710103	106	7.70	0710367	109	12.10
0656390	215	689.00	0710104	106	11.90	0710368	109	12.10
0656391	215	726.00	0710105	106	11.90	0710397	111	9.10
0656392	215	761.00	0710111	107	5.10	0710467	109	12.10



Order no.	Page	List price in €	Order no.	Page	List price in €	Order no.	Page	List price in €
0710468	109	12.10	0744198	120	47.25	0806504	61	49.50
0710497	111	9.10	0744199	120	80.00	0806513	61	181.00
0712121	105	175.00	0750102	123	211.00	0806521	62	52.00
0712124	105	215.00	0750112	123	123.00	0806522	62	84.00
0715101	112	91.00	0750113	123	47.40	0806523	62	103.00
0715103	112	102.00	0750122	123	109.00	0806524	62	119.00
0715201	112	143.00	0750601	123	28.30	0806525	62	162.00
0715303	112	128.00	0752101	124	163.00	0806526	62	181.00
0715305	112	121.00	0752103	124	208.00	0806527	62	201.00
0715307	112	181.00	0753110	122	28.10	0806528	62	221.00
0715903	112	13.70	0753120	122	69.00	0806540	62	310.00
0715907	112	13.70	0754101	125	112.00	0806542	62	682.00
0715915	112	19.10	0756101	125	67.00	0807101	60	64.00
0715917	112	15.00	0763100	128	315.00	0810501	63	312.00
0715919	112	15.00	0770102	126	235.00	0810502	63	330.00
0715921	112	21.10	0770103	126	272.00	0810503	63	346.00
0715922	112	15.90	0770201	126	300.00	0810504	63	367.00
0715923	112	15.80	0770205	126	425.00	0815510	63	328.00
0715925	112	19.30	0772024	127	856.00	0815514	63	346.00
0715926	112	15.00	0780021	132	123.00	0815518	63	432.00
0715929	112	15.00	0780023	132	157.00	0815530	63	372.00
0715940	113	2.90	0780032	133	225.00	0815534	63	549.00
0715950	113	28.60	0780033	133	310.00	0815540	63	607.00
0715955	113	18.10	0780042	133	218.00	0816501	64	393.00
0720103	113	274.00	0780043	133	295.00	0816502	64	443.00
0728105	114	468.00	0780072	132	146.00	0816503	64	511.00
0728106	114	455.00	0780073	132	265.00	0816504	64	583.00
0728107	114	520.00	0780074	132	292.00	0816505	64	664.00
0728108	114	725.00	0780091	133	429.00	0816506	64	749.00
0728109	114	1045.00	0780092	133	482.00	0816507	64	1058.00
0728110	114	2466.00	0780093	133	991.00	0816508	64	1117.00
0728201	114	1192.00	0780094	133	1025.00	0816509	64	1187.00
0728202	114	853.00	0780101	129	682.00	0816510	64	1274.00
0728203	114	795.00	0780102	129	866.00	0816511	64	1374.00
0728204	114	552.00	0780104	129	780.00	0816512	64	1470.00
0728205	114	558.00	0780105	129	889.00	0817512	65	1263.00
0728206	114	531.00	0780107	129	2236.00	0817514	65	1313.00
0728207	114	621.00	0780108	129	2493.00	0817516	65	1470.00
0728208	114	809.00	0780174	129	56.00	0817518	65	1668.00
0728209	114	1070.00	0780175	129	44.00	0817520	65	1866.00
0728210	114	2525.00	0780177	129	141.00	0817522	65	2070.00
0728910	114	1473.00	0780178	129	130.00	0817524	65	2278.00
0728915	114	1461.00	0780201	130	630.00	0817526	65	2520.00
0728920	114	2114.00	0780202	130	788.00	0819501	66	208.00
0735101	115	460.00	0780206	130	1578.00	0819502	66	232.00
0735102	115	415.00	0780301	131	597.00	0819503	66	256.00
0735103	115	482.00	0780302	131	754.00	0819505	66	292.00
0735901	115	254.00	0780306	131	1511.00	0819510	66	281.00
0735902	115	211.00	0782160	134	796.00	0819511	66	354.00
0741178	118	130.00	0782181	134	254.00	0819512	66	403.00
0741179	118	130.00	0782191	134	1321.00	0819513	66	465.00
0741180	118	130.00	0783012	134	3996.00	0819514	66	573.00
0741182	118	216.00	0783070	134	334.00	0819515	66	660.00
0744101	117	2099.00	0784108	135	3495.00	0819516	66	757.00
0744112	117	292.00	0784181	135	705.00	0819517	66	855.00
0744114	117	310.00	0784190	135	198.00	0819519	66	1587.00
0744116	117	474.00	0785108	127	721.00	0819521	66	1709.00
0744122	120	326.00	0785109	127	1764.00	0819523	66	2013.00
0744124	120	348.00	0788104	136	1275.00	0819525	66	2313.00
0744132	121	34.25	0788180	136	259.00	0819527	66	2660.00
0744136	120	297.00	0788904	137	1015.00	0822301	73	108.00
0744170	117	289.00	0788980	137	83.00	0822302	73	163.00
0744171	117	289.00	0788990	137	368.00	0822303	73	299.00
0744172	119	351.00	0800501	60	21.40	0822304	73	488.00
0744174	119	351.00	0800502	60	25.90	0824302	73	219.00
0744175	119	111.50	0800503	60	29.70	0824303	73	221.00
0744176	119	111.50	0800504	60	35.10	0849501	72	831.00
0744188	117	89.00	0800513	60	124.00	0849502	72	988.00
0744189	117	89.00	0806501	61	38.50	0850511	72	656.00
0744190	121	70.00	0806502	61	42.10	0850512	72	729.00
0744192	121	70.00	0806503	61	45.80	0850514	72	775.00





Order no.	Page	List price in €	Order no.	Page	List price in €	Order no.	Page	List price in €
0850516	72	828.00	0882304	91	463.00	0898103	75	25.50
0850518	72	866.00	0882306	91	744.00	0898104	75	29.10
0854301	74	290.00	0884501	80	998.00	0898105	75	33.70
0854302	74	352.00	0885501	80	207.00	0898106	75	47.70
0854303	74	377.00	0885502	80	229.00	0898107	75	54.00
0854304	74	410.00	0885503	80	241.00	0898108	75	59.00
0864321	79	372.00	0885504	80	288.00	0898109	75	65.00
0864322	79	447.00	0885505	80	366.00	0898110	75	72.00
0864323	79	484.00	0885506	80	422.00	0898111	75	76.00
0864324	79	526.00	0885507	80	537.00	0898112	75	94.00
0864325	79	567.00	0885508	80	609.00	0898113	75	102.00
0864326	79	608.00	0886503	91	27.50	0898114	75	109.00
0864327	79	653.00	0886505	91	31.70	0898115	75	115.00
0864328	79	698.00	0886507	91	27.50	0898116	75	123.00
0870301	76	370.00	0886513	91	48.80	0898117	75	131.00
0870302	76	387.00	0888101	81	62.00	0898118	75	138.00
0870303	76	416.00	0888501	81	193.00	0898119	75	145.00
0870304	76	455.00	0888502	81	193.00	0898120	75	153.00
0870305	76	499.00	0888503	81	193.00	0898121	75	161.00
0870306	76	541.00	0888504	81	202.00	0898122	75	168.00
0870307	76	772.00	0888505	81	209.00	0898123	75	176.00
0870309	76	843.00	0888506	81	234.00	0898124	75	185.00
0870311	76	928.00	0888507	81	239.00	0898125	75	193.00
0870801	78	88.00	0888508	81	247.00	0898126	75	200.00
0870802	78	90.00	0888509	81	257.00	0898127	75	208.00
0870803	78	91.00	0888510	81	264.00	0898128	75	217.00
0870804	78	92.00	0888511	81	272.00	0898132	75	250.00
0870805	78	93.00	0888512	81	281.00	0898136	75	281.00
0870807	78	103.00	0888513	81	292.00	0898140	75	313.00
0870809	78	117.00	0888514	81	304.00	0898142	75	327.00
0870811	78	128.00	0888515	81	310.00	0898146	75	359.00
0870821	78	88.00	0888516	81	324.00	0898150	75	394.00
0870822	78	90.00	0888517	81	331.00	0898154	75	424.00
0870823	78	91.00	0888518	81	343.00	0898158	75	457.00
0870824	78	97.00	0888519	81	354.00	0898162	75	732.00
0870825	78	99.00	0888520	81	362.00	0912501	67	92.00
0870827	78	113.00	0888521	81	370.00	0912502	67	104.00
0870829	78	129.00	0890511	79	78.00	0912503	67	119.00
0870831	78	148.00	0892332	82	90.00	0912504	67	136.00
0870841	78	192.00	0892333	82	91.00	0912505	67	149.00
0870842	78	198.00	0892334	82	101.00	0912506	67	164.00
0870843	78	203.00	0892336	82	123.00	0912507	67	176.00
0870844	78	211.00	0892339	82	163.00	0912508	67	190.00
0870845	78	229.00	0892340	82	229.00	0912521	67	491.00
0870847	78	273.00	0892501	82	473.00	0996701	172	87.00
0870849	78	333.00	0892502	82	580.00	0996701	223	87.00
0870851	78	408.00	0892503	82	714.00	0996705	172	166.00
0870901	77	140.00	0892504	82	900.00	0996705	223	166.00
0870903	77	121.00	0892505	82	1142.00	1271451	53	101.00
0870905	77	121.00	0894504	83	281.00	1271452	53	117.00
0870907	77	121.00	0894510	83	748.00	1271455	53	67.00
0870909	77	121.00	0894514	83	1009.00	1276591	54	21.20
0870911	77	140.00	0894518	83	1303.00	1276592	54	20.30
0870921	77	153.00	0894522	83	1604.00	1276593	54	28.20
0870923	77	132.00	0894526	83	1650.00	1320416	19	130.00
0870925	77	132.00	0894530	83	1936.00	1320417	19	130.00
0870927	77	132.00	0894534	83	1987.00	1320516	19	164.00
0870929	77	132.00	0894538	83	3469.00	1320517	19	164.00
0870931	77	132.00	0894542	83	4525.00	1320518	19	446.00
0870933	77	153.00	0894546	83	5617.00	1320518	39	446.00
0870941	77	359.00	0894550	83	6673.00	1320519	19	209.00
0870943	77	261.00	0894554	83	7731.00	1320522	19	265.00
0870945	77	229.00	0894804	83	202.00	1326416	20	180.00
0870947	77	229.00	0894806	83	229.00	132641660	18	246.00
0870949	77	229.00	0894810	83	247.00	1326417	20	180.00
0870951	77	229.00	0894820	83	273.00	132641760	18	246.00
0870953	77	261.00	0894834	83	310.00	1326418	20	254.00
0870955	77	359.00	0894854	83	1019.00	132641860	18	315.00
0882300	91	331.00	0894872	83	1058.00	1326422	20	322.00
0882301	91	360.00	0898101	75	12.90	132642260	18	380.00
0882303	91	395.00	0898102	75	21.60	1326516	21	180.00



Order no.	Page	List price in €	Order no.	Page	List price in €	Order no.	Page	List price in €
1326517	21	180.00	1372422	53	536.00	1921514	84	449.00
1326518	21	265.00	137242260	52	582.00	1921516	84	449.00
1326904	28	646.00	1372428	53	617.00	1921518	84	476.00
1326906	29	641.00	137242860	52	660.00	1921520	84	488.00
1326908	28	552.00	1375502	55	281.00	1921522	84	495.00
1326910	29	634.00	1376514	54	583.00	1921524	84	556.00
1326912	25	361.00	1722502	94	161.00	1921526	84	556.00
1326914	20	387.00	1723502	94	202.00	1921528	84	641.00
1326916	26	447.00	1724502	94	334.00	1921530	84	660.00
1326918	24	567.00	1726502	95	389.00	1921532	84	678.00
1326920	25	615.00	172650260	99	441.00	1921534	84	696.00
1326922	26	504.00	1726506	88	429.00	1921536	84	976.00
1326924	27	500.00	1726506	95	429.00	1921538	84	1153.00
1326928	27	537.00	172650660	88	479.00	1921540	84	1214.00
1326930	24	736.00	172650660	99	479.00	1921542	84	1282.00
1326932	23	405.00	1726510	95	754.00	1922510	90	341.00
1326990	23	44.00	1726514	95	934.00	1922512	90	341.00
1330522	34	449.00	1728502	95	326.00	1922514	90	346.00
1330528	34	685.00	1728506	95	415.00	1922516	90	346.00
1330532	34	1118.00	1728510	95	677.00	1922518	90	359.00
1330534	34	1353.00	1728514	95	866.00	1922520	90	370.00
1331522	34	521.00	1730502	96	431.00	1922522	90	383.00
1331528	34	768.00	1730506	96	486.00	1922524	90	429.00
1331532	34	1183.00	1734502	97	448.00	1922526	90	429.00
1331534	34	1360.00	173450260	99	498.00	1922528	90	511.00
1334522	36	416.00	1734506	97	513.00	1922530	90	523.00
1334528	36	584.00	173450660	99	561.00	1922532	90	540.00
1334532	36	1020.00	1734522	98	581.00	1922534	90	558.00
1334534	36	1208.00	1739910	95	45.10	1922536	90	816.00
1335522	36	476.00	1739910	96	45.10	1922538	90	992.00
1335528	36	672.00	1739910	97	45.10	1922540	90	1075.00
1335532	36	1097.00	1739910	98	45.10	1922542	90	1111.00
1335534	36	1260.00	1739910	99	45.10	1923100	87	899.00
1340522	35	486.00	1739920	94	16.80	1923200	87	899.00
1340528	35	927.00	1866210	71	198.00	1923300	87	899.00
1340532	35	1251.00	1866410	68	234.00	1923510	86	1239.00
1340534	35	1539.00	186641060	69	292.00	1923512	86	1239.00
1341522	35	550.00	1866413	68	305.00	1923514	86	1251.00
1341528	35	990.00	186641360	69	360.00	1923516	86	1251.00
1341532	35	1313.00	1866417	68	387.00	1923518	86	1304.00
1341534	35	1601.00	186641760	69	439.00	1923520	86	1327.00
1342522	37	447.00	1866420	68	441.00	1923522	86	1339.00
1342528	37	824.00	186642060	69	491.00	1923524	86	1398.00
1342532	37	1141.00	186642160	71	1567.00	1923526	86	1404.00
1342534	37	1419.00	1866510	68	281.00	1923528	86	1510.00
1343522	37	510.00	1866513	68	337.00	1923530	86	1544.00
1343528	37	889.00	1866517	68	439.00	1923532	86	1579.00
1343532	37	1204.00	1866520	68	491.00	1923534	86	1639.00
1343534	37	1481.00	1866521	71	1533.00	1923536	86	1991.00
1348722	22	685.00	1866610	70	383.00	1923538	86	2226.00
1348728	22	877.00	186661060	70	394.00	1923540	86	2397.00
1352516	41	438.00	1866613	70	439.00	1923542	86	2602.00
1352517	41	493.00	186661360	70	450.00	1923574	87	1996.00
1352518	41	902.00	1866617	70	552.00	1923576	87	1762.00
1352522	41	1059.00	186661760	70	563.00	1923578	87	2584.00
1353522	40	554.00	1866620	70	597.00	1923580	87	3171.00
1361716	48	371.00	186662060	70	608.00	1924100	89	564.00
1361718	48	421.00	1920574	85	1270.00	1924190	89	90.00
1361722	48	473.00	1920576	85	891.00	1924200	89	564.00
1361728	48	543.00	1920578	85	2197.00	1924300	89	659.00
1363722	49	484.00	1920580	85	2624.00	1924510	88	922.00
1363728	49	563.00	1920910	85	104.00	1924512	88	922.00
1365722	50	458.00	1920910	90	104.00	1924514	88	934.00
1365728	50	510.00	1920914	85	111.00	1924516	88	946.00
1367718	51	476.00	1920914	90	111.00	1924518	88	981.00
1367722	51	575.00	1920920	85	117.00	1924520	88	981.00
1367728	51	724.00	1920920	90	117.00	1924522	88	1016.00
1372416	53	438.00	1920924	85	140.00	1924524	88	1069.00
137241660	52	487.00	1920924	90	140.00	1924526	88	1075.00
1372418	53	481.00	1921510	84	449.00	1924528	88	1169.00
137241860	52	518.00	1921512	84	449.00	1924530	88	1215.00



Order no.	Page	List price in €	Order no.	Page	List price in €	Order no.	Page	List price in €
1924532	88	1257.00	1998501	222	73.00	4320228	228	70.00
1924534	88	1316.00	1998720	19	82.00	4320810	228	149.00
1924536	88	1621.00	1998720	21	82.00	4320814	228	212.00
1924538	88	1868.00	1998720	22	82.00	4320818	228	227.00
1924540	88	1996.00	1998720	23	82.00	4320822	228	232.00
1924542	88	2232.00	1998720	24	82.00	4320826	228	232.00
1924574	89	1645.00	1998720	25	82.00	4320830	228	232.00
1924576	89	1409.00	1998720	26	82.00	4320834	228	296.00
1924578	89	2349.00	1998720	27	82.00	4320838	228	296.00
1924580	89	3054.00	1998720	28	82.00	4320842	228	296.00
1997501	19	57.00	1998720	29	82.00	4320846	228	296.00
1997501	21	57.00	1998720	34	82.00	4322810	229	53.00
1997501	22	57.00	1998720	35	82.00	4329010	228	8.50
1997501	23	57.00	1998720	36	82.00	4329026	228	19.40
1997501	24	57.00	1998720	37	82.00	4329046	228	39.00
1997501	25	57.00	1998720	39	82.00	4340210	230	18.20
1997501	26	57.00	1998720	40	82.00	4340214	230	20.00
1997501	27	57.00	1998720	48	82.00	4340218	230	29.50
1997501	28	57.00	1998720	49	82.00	4340222	230	51.00
1997501	29	57.00	1998720	50	82.00	4340226	230	61.00
1997501	34	57.00	1998720	51	82.00	4342410	229	14.00
1997501	35	57.00	1998720	54	82.00	4342610	229	32.00
1997501	36	57.00	1998720	55	82.00	4350210	230	36.50
1997501	37	57.00	1998720	86	82.00	4350218	230	60.00
1997501	39	57.00	1998720	87	82.00	4351610	230	30.50
1997501	40	57.00	1998720	94	82.00	4351618	230	70.00
1997501	48	57.00	1998720	95	82.00	4352412	230	17.50
1997501	49	57.00	1998720	96	82.00	4352418	230	27.50
1997501	50	57.00	1998720	97	82.00	4352422	230	52.00
1997501	51	57.00	1998720	98	82.00	4353410	230	64.00
1997501	54	57.00	1998720	99	82.00	4353510	230	88.00
1997501	55	57.00	1998720	222	82.00	4357610	230	13.50
1997501	86	57.00	1998720	223	82.00	4357620	230	23.00
1997501	87	57.00	1998722	223	68.00	4358410	231	20.00
1997501	94	57.00	1998730	223	136.00	4358420	231	35.50
1997501	95	57.00	1998732	223	82.00	4358810	231	23.00
1997501	96	57.00	1998740	223	114.00	4359210	231	29.00
1997501	97	57.00	1998740	223	114.00	4359410	231	37.00
1997501	98	57.00	1998742	223	410.00	4360210	229	30.00
1997501	99	57.00	1998742	223	410.00	4360212	229	42.00
1997501	222	57.00	1998744	223	410.00	4360214	229	48.00
1998501	19	73.00	1998744	223	410.00	4360218	229	62.00
1998501	21	73.00	1998746	223	561.00	4360810	231	41.00
1998501	22	73.00	1998746	223	561.00	4361410	231	62.00
1998501	23	73.00	1998748	223	561.00	4380110	228	40.50
1998501	24	73.00	1998748	223	561.00	4380112	228	55.00
1998501	25	73.00	1998760	150	166.00	4380114	228	99.00
1998501	26	73.00	1998780	18	108.00	4380120	228	40.00
1998501	27	73.00	1998780	52	108.00	4380122	228	55.00
1998501	28	73.00	1998780	69	108.00	4380124	228	99.00
1998501	29	73.00	1998780	70	108.00	4380130	228	53.00
1998501	34	73.00	1998780	71	108.00	4380132	228	83.00
1998501	35	73.00	1998780	99	108.00	4380134	228	100.00
1998501	36	73.00	1998780	224	108.00	4380140	228	50.00
1998501	37	73.00	1998801	68	111.00	4380142	228	55.00
1998501	39	73.00	1998801	70	111.00	4380150	229	61.00
1998501	40	73.00	1998801	71	111.00	4380151	229	66.00
1998501	48	73.00	1998801	222	111.00	4380152	229	77.00
1998501	49	73.00	1998802	68	96.00	4380154	229	88.00
1998501	50	73.00	1998802	70	96.00	4380156	229	124.00
1998501	51	73.00	1998802	71	96.00	4380160	229	79.00
1998501	54	73.00	1998802	222	96.00	4380170	229	94.00
1998501	55	73.00	4310110	228	14.50			
1998501	86	73.00	4310115	228	25.10			
1998501	87	73.00	4310120	228	43.50			
1998501	94	73.00	4310125	228	90.00			
1998501	95	73.00	4320210	228	24.00			
1998501	96	73.00	4320212	228	32.00			
1998501	97	73.00	4320214	228	35.00			
1998501	98	73.00	4320220	228	38.00			
1998501	99	73.00	4320224	228	51.00			



0 - 9	Page
3 point internal micrometers, analogue	88
3 point internal measuring pistol, digital	84
3 point internal micrometers, digital	86

A	
Acute angle squares 45°	165
Adjustable squares	167
Adjustable V-blocks	188
Alpha square	166
Aluminium straight edges	177

B	
Bench centres & accessories	129-133
Bevel protractors	169-171
Blade micrometers	74

C	
Cable for data transmission	222
Calibration service	228-231
Calipers for 3/5 point measurement	42
Calipers for external locking grooves, analogue & digital	41
Calipers for internal grooves, analogue & digital	40
Calipers with gripper points analogue	38
Calipers with integrated Wireless	18
Calipers, analogue	8-16, 30-33
Calipers, digital	18-29,34-37,48-55
Carpenters squares	166
Centre squares	163
Chamfer gauge	195
Combined internal / external calipers	145
Compact measuring stands	126
Concentricity measuring gauge with disc supports	135
Connecting cables for electronic instruments	222
Convertor mm/inch	193
Crankshaft gauges	115

D	
Data acquisition / data transmission	222-225
Data cables	222
Depth attachment base for pocket calipers	20
Depth gauges with integrated wireless	52
Depth gauges, digital	48-55
Depth micrometers	91
Dial calipers	15
Dial comparator gauges »MICROTAST«	105
Dial gauges, analogue	100-105
Dial gauges, shockproof	102,104
Dial gauges, small	100
Dial gauges, water and oil proof	102
Dial gauges, with concentric mm-display	100
Dial gauges, with extended measuring range	101
Dial gauges, with reverse action plunger	105
Dial micrometers	73
Dial test indicators and accessories	112
Dial thickness gauges	113
Digital pocket calipers	18-29
Digital pocket calipers for specific measuring tasks	24-29
DIN thread conversion	193
Disc micrometers	73
Dividers	141,143
Double V-blocks	186
Drill and steel wire hole gauges	197
Duo-Fix pocket vernier caliper	12

E	
Extensions for dial gauges	107

F	
Feeler gauge tapes	200,201
Feeler gauge tapes INOX	200
Feeler gauges	198,199
Filetor ISO thread convertor	193
Flange squares	163
Flexible steel rules	176,177
Frame levels	189

G	
Gauge block holders	208
Gauge block inspection sets for micrometers and calipers	209
Gauge block maintenance set	209
Gauge blocks	205-207
Gear tooth calipers	44

H	
Height and scribing gauges	148
Height and scribing gauges, digital	149,15
Holder for external micrometers	60
Holder for feeler gauge tapes	200
Holder for internal micrometers	81

I	
Indicators	94-99
Indicators with integrated wireless	99
Inspection set for micrometers and calipers	209
Inspection square set	162
Inspection squares, hardened	155
Integrated Wireless caliper	18
Integrated Wireless Indicators	99
Integrated Wireless micrometers	69
Interior circumference tapes	179
Internal calipers	142
Internal micrometer digital	86
Internal micrometers with interchangeable extensions	82
Internal micrometers with measuring jaws	80
Internal micrometers, cylindrical version	81
Internal precision bore gauges	114
i-Stick receiver for intergated wireless	224

K	
Knife edge rule	183
Knife edge squares, hardened	161

L	
Levels	189
Lug back	106



M	Page
Machine levels with V-groove	189
Magnetic angle gauge	190
Magnetic back	106
Marking calipers	146
Marking gauges	145
Measuring heads	90
Measuring inserts	108-111
Measuring stands	126
Micrometers for thread flank measurement	76
Micrometers for tube wall measurement	73
Micrometers with DataVariable	68
Micrometers with DataVariable, linear	70
Micrometers with integrated wireless	69
Micrometers with integrated wireless, linear	70
Micrometers with reduced measuring faces	74
Micrometers, external, analogue	60-66
Micrometers, external, digital	67-71
Micrometers, external, with exchangeable anvils	66
Micrometers, external, with interchangeable inserts	66
Mitre squares	164

N	Page
Nozzle gauges	196

P	Page
Parallel blocks, set	188
Pin gauge holder	212
Pin gauges, set	213
Plane parallel jaws	208
Plug gauges	216
Pocket calipers	Aug 29
Pocket vernier caliper »Duo-Fix«	12
Pocket vernier caliper, for lefthanded	13
Pocket vernier calipers	18-29
Pocket vernier calipers, parallax-free reading	11
POCKET-TALENT	23
Precision feeler gauge tapes	200,201
Precision reference sheets	202
Protractors	169-171

R	Page
Radius gauge	43
Radiused measuring jaws	208
Ring gauges	215
Roller supports for bench centre	133

S	Page
Screw pitch gauges	198
Scribers	141,143
Set of 3 point internal micrometers, analogue	85
Set of 3 point internal micrometers, measuring pistol	89
Set of external micrometers, analogue	62
Setting device for internal precision bore gauges	114
Setting standards for micrometers	75
Small depth gauge, digital	55
Snap gauges, double jaw	214
Software for data acquisition	222
Spring dividers	143
Squares with base	145-158
Squares with hard and slim blade	159
Squares without base	154-158
Stand for gaugeblock holders	208
Steel gauge block, sets	210,211
Steel rules	176-178
Steel rules, flexible	176-177
Steel scale tapes for circumference and diameter	179
Steel square	158
Straight edges with bevelled edge	180
Surface roughness standards	204

T	Page
Tapered hole gauges	195
Tapes for circumference and diameter	179
Thread cutting gauges	190,191
Thread flank inserts for external measurement	76
Thread flank setting standards for external measurement	77
Thread plug gauges, individual and set	218
Thread ring gauges, individual and set	218,219
Tolerator ISO tolerance convertor	193
Tyre profile depth gauge	14

U	Page
UHRSTAST comparator gauge & accesories	117
Universal bevel protractors, analogue & digital	172,173
Universal calipers, digital, Pocket-Talent	22,23
Universal comparator gauge & accessories	116-121
Universal indicator stands & magnetic base & accessories	122
Universal magnetic holder	125
Universal measuring support	128

V	Page
V-blocks	184-187
Vernier depth gauges	55-58

W	Page
Wall holders with feelergauge tape sets	228
Welding gauges	221
Wire thickness micrometer	95
Wireless data transmission	252
Wooden cases	73
Workshop calipers, analogue	45-47
Workshop calipers, analogue, long measuring jaws	32
Workshop calipers, digital	34-37
Workshop calipers, parallax-free reading	33







A series of horizontal lines forming a grid for writing notes, consisting of two columns of lines.









A large area of the page is filled with horizontal lines, organized into two columns. Each column contains 20 lines, providing a space for handwritten notes.







A series of horizontal lines forming a grid for notes, consisting of two columns of lines.



A large area of the page is filled with horizontal lines, organized into two columns. Each column contains 20 lines, providing a space for writing notes.









HELIOS · PREISSER

THE TRADE SPECIALISTS



**WE OFFER INDIVIDUAL  
CUSTOM-MADE PRODUCTS**

- Specially tailored to your unique measurement task
- Short delivery times
- Made in Germany